

BIG KAISER



A Member of the
BIG DAISHOWA Group

Volume 4

HIGH PERFORMANCE TOOLING SOLUTIONS





Awaji Factory, Japan



Awaji Factory, Japan



Logistic center, Japan



OUR VISION OF PRECISION

We strive for perfection. This is why our products meet the highest requirements in the industry thanks to uncompromising quality control combined with decades of experience.

Our vision is precision
– our goal is perfection.

BIG KAISER is a member of the Japanese BIG DAISHOWA Group. We manufacture our products exclusively in Japan and Switzerland. Together we produce precision tools and systems for the metalworking industry. Especially for biomedical engineering, automotive, aerospace and watchmaking industries, the quality and precision of our products is indispensable. Around 1000 employees worldwide contribute to the uncompromising quality of the more than 20,000 items in our product range.

EXPERTISE – GLOBALLY GUARANTEED

Our dense network of worldwide contacts guarantees you competent advice on site. Our expert teams will be happy to help you find individual product solutions for your needs.



Heinz Kaiser



Rümlang, Switzerland

TWO STORIES, ONE GOAL

BIG DAISHOWA was founded in 1967 in Osaka, Japan, where it first began producing tool holders to meet the most demanding tool applications. The vision has not changed since then: highest precision with the best quality products enables the greatest possible benefit for production facilities.

BIG KAISER: In 1948, 23-year-old Heinz Kaiser decides to set up his own business. His vision: The development of high-quality tools. His goals: The modern tools produced in his workshop should meet high standards. With his Schaublin 102 TO lathe, he moves into his first own workshop in Rümlang, Switzerland. After decades of partnership, KAISER became a member of the BIG DAISHOWA Group in 2015 and has since become BIG KAISER.



Awaji Factory No.3, Japan

PERFORMANCE PROVIDES PROFIT AND PAYS OFF

You benefit from highly precise and reliable tools in several ways. On the one hand, they guarantee maximum process reliability. On the other hand, they make expensive work steps such as honing or grinding partially redundant. This saves time and cost in the production process without having to sacrifice quality to the highest standards.



INVENTING THE FUTURE



Thanks to decades of experience and continuous investment in research and development, BIG KAISER products today stand for uncompromising quality. We see research and development of innovative products as indispensable to achieve the highest standard in quality and precision. Results of this philosophy are products like the market-leading BIG-PLUS® Spindle System or digital wireless communicable boring tools of the EWE series.

BIG DAISHOWA GROUP

Production facilities	8 in Japan, 1 in Switzerland
CNC machines	> 700 (>200 grinding machines)
Employees worldwide	> 1.000
Production floorspace worldwide	> 200.000 m²
Tech Centers	3 (Japan, Switzerland, USA)
Logistic Centers	>15.000 m² in total (Japan, Switzerland, USA)
Wide product range	CAPTO 3-4-5-6-8 / HSK 15-20-25-32-40-50-63- 100-125 Type A-E-F-T / BBT30-40-50, BDV40-50

The BIG KAISER catalogue is constantly being updated with new products. To keep up to date with the latest news, check the online catalogue on our website www.bigkaiser.eu or subscribe to our newsletter and you will always be kept up to date with new products.



Content

TOOL HOLDERS		
Tool Holders BBT/BT (JIS B6339)	57	A.1
Tool Holders BDV/DV (DIN 69871)	127	A.2
Tool Holders HSK	163	A.3
Tool Holders BIG CAPTO	229	A.4
Tool Holders and Components CK	251	A.5
Tool Holders Cylindrical Shank	263	A.6
Modular Turning / Lathe Tools	277	A.7
Collets & Accessories	321	A.8
MODULAR BORING TOOLS		
Rough Boring Heads	379	B.1
Fine Boring Heads with Centric Cutting Edge	395	B.2
Fine Boring Heads with Peripheral Cutting Edge	435	B.3
Large Diameter Boring Tools	453	B.4
Indexable Inserts and Cutters	467	B.5
Spare Parts	497	B.6
CUTTING TOOLS		
Indexable End Mills	517	C.1
Indexable Insert Drills and Chamfer Mills	545	C.2
MEASURING INSTRUMENTS		
Measuring Instruments	575	D.1

MEGA Micro Chuck

Ultra slim design eliminates any interference.



Clamping range:
Ø 0.45 - 8.05

Features ▶ P. 19

BBT Shank	58
BDV Shank	128
HSK Shank	164/216/223
BIG CAPTO Shank	230
Cylindrical Shank	264
For N/C Lathe	314

MEGA New Baby Chuck

Most reliable high precision collet chuck in the world.

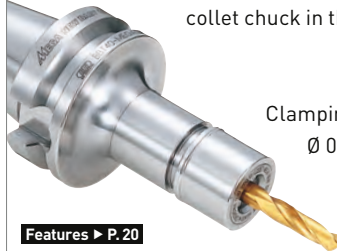

Clamping range:
Ø 0.25 - 25.4

Features ▶ P. 20

BBT Shank	60
BDV Shank	129
HSK Shank	166/218/224
BIG CAPTO Shank	232

MEGA E Chuck

Original and exclusive design for small endmilling.



Clamping range:
Ø 3 - 12

Features ▶ P. 21

BBT Shank	64
BDV Shank	131
HSK Shank	170/225
BIG CAPTO Shank	235

MEGA Double Power Chuck

Specialist for heavy-duty cutting.



Clamping range:
Ø 3 - 42

Features ▶ P. 22

BBT Shank	66
BDV Shank	132
HSK Shank	172/226
BIG CAPTO Shank	237

MEGA Perfect Grip

Unique design anti pulling out cutter milling chuck.



Clamping range:
Ø 16 - 32

Features ▶ P. 23

BBT Shank	70
DV Shank	133
HSK Shank	176

New Baby Chuck

High precision collet chuck for various applications.



Clamping range:
Ø 0.25 - 20

Features ▶ P. 26

BT Shank	71
DV Shank	134
HSK Shank	177
Cylindrical Shank	265
For N/C Lathe	309

New Baby Chuck NRA

Collet chuck with adjustable runout.



Clamping range:
Ø 0.5 - 20

Features ▶ S. 26

BBT Shank	73
HSK Shank	179

New Hi-Power Milling Chuck

Reliable milling chuck with slim design.



Clamping range:
Ø 3 - 42

Features ▶ P. 27

BBT Shank	74
BDV Shank	136
HSK Shank	180
BIG CAPTO Shank	239
CK Shank	258
Cylindrical Shank	268

New Hi-Power Milling Chuck NRA

Power chuck with adjustable runout.



Clamping range:
Ø 3 - 32

Features ▶ S. 27

BBT Schaft	77
HSK Schaft	183

Hydraulic Chuck

Various design with outstanding repeatability.

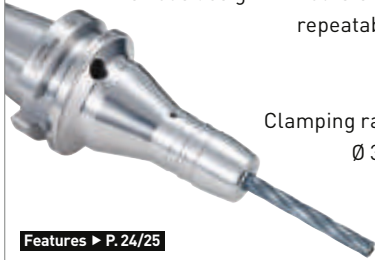

Clamping range:
Ø 3 - 42

Features ▶ P. 24/25

BBT Shank	78
BDV Shank	138
HSK Shank	184/220
BIG CAPTO Shank	240
Cylindrical Shank	267

Mold Chuck

Slim and good runout sidelock holder.



Clamping range:
Ø 3 - 20

Features ▶ S. 39

BBT Shank	87
HSK Shank	188

Shrink Chucks

Shrink fit solution with BIG-PLUS® interface.



Clamping range:
Ø 4 - 20

BBT Shank	88
BDV Shank	141
HSK Shank	189
BIG CAPTO Shank	242
Cylindrical Shank	269

CK Shanks

Various CK shanks for boring systems.



Features ▶ P. 28/29

BT/BBT Shank	91
DV/BDV Shank	142
HSK Shank	191/222
BIG CAPTO Shank	243
Reductions, Extensions	252
Cylindrical Shank	271

Face Mill Arbors

Eliminates chatter for smoother finish.



BBT Shank	96
BDV Shank	146
HSK Shank	194
BIG CAPTO Shank	244
CK Shank	257

Smart Damper for Milling

Unique modular damping face mill arbor.

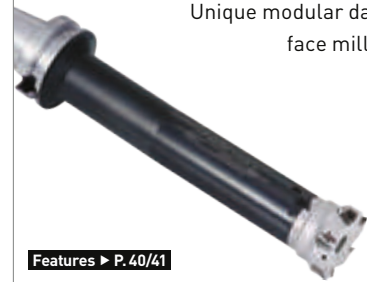

Features ▶ P. 40/41

BBT Shank	98
BDV Shank	148
HSK Shank	196

Side Lock Holders

Clamping range:
Ø 6 - 50



BBT Shank	101
BDV Shank	150
HSK Shank	198
BIG CAPTO Shank	245
CK Shank	256

HOLDERS for Screw-On Cutters

General metric screw in cutter holder with BIG-PLUS®.



BBT Shank	103
BDV Shank	151

Morse Taper Holders



BBT Shank	104
HSK Shank	200
BIG CAPTO Shank	257

MEGA Synchro Tapping Holder

Improves thread quality and tool life.

Tapping range:
M1 - M36



Features ▶ P.42/43

BBT Shank	106
BDV Shank	152
HSK Shank	201
BIG CAPTO Shank	248
CK Shank	260
Cylindrical Shank	273
For N/C Lathe	315

Angle Heads

Eliminates multiple set up.

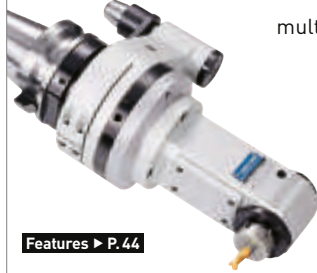

Features ▶ P.44

BBT Shank	108
BDV Shank	153
HSK Shank	203
Stop Block	376

Air Turbine Spindles

Air-driven speed increaser for micro-machining.

Max. 80 000 min⁻¹



Features ▶ P.45

BBT Shank	123
BDV Shank	159
HSK Shank	213
Stop Block	376

BIG CAPTO Adapter



BBT Shank	105/249
Extension	249
Reduction	249

Millturn Tooling BBT

Modular turning tools with BBT.



Turning Tool overview	280
Turning Holder	287

Millturn Tooling HSK-T

Unique modular turning system.



Modular Tool overview	290
Turning Holder	292

Millturn Tooling BIG CAPTO

Modular turning tools and high precision rotary tool holders.



Turning Tool overview	298
Turning Holder	300

Smart Damper Turning

For boring applications on turning machines.



Features ▶ P.40/41

HSK-T Shank	297
BIG CAPTO Shank	308
Cylindrical Shank	316

N/C Lathe Tooling

For improved efficiency and reliability of production on NC lathe.



Features ▶ P.46

Collet Chuck	309
Hydraulic Chuck	318

Tool Assembly Stations



Torque Fit

With integrated torque measuring system.



Kombi Grip

For HSK and BIG CAPTO.

Features ▶ P.54

Tooling Mate	367
Kombi Grip	368
Torque Fit	369

Cleaners

Maintain accuracy of high precision collet chucks.



α Taper Cleaners	370
TK Cleaner	370
α Wiper Cleaners	370
α Tooling Cleaners	371
Spindle Cleaners	371
Flange Face Cleaners	372

Pull Stud Bolts / Coolant Pipes



Pull Stud Bolt

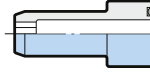

Coolant Pipe

For HSK form A, E and F.

Coolant Pipes	228
Pullstud Bolts	374
Pullstud Wrenches	375

Rough Boring Heads MW



Extremely fast roughing for small holes.

Boring range:
Ø 16 - 21

Features ▶ S.37

MW, Ø 16 - 21	272/382
---------------	---------

Rough Boring Heads SW



Perfect roughing with easy setup cartridges.

Boring range:
Ø 20 - 203

Features ▶ P.37

SW, Ø 20 - 203	383
----------------	-----

Centric Fine Boring Heads



The most precise boring system with centric boring bar, available in analogue and digital with wireless communication to BIG KAISER App.

Features ▶ P.33/35/36

EWE, Ø 2 - 152	398/418
EWE, Ø 25 - 203	437
EWN, Ø 0.4 - 152	399/419/430
EWB, Ø 2 - 50	399/418

Peripheral Fine Boring Heads



Ultra precise fine boring head, available in analogue and digital with wireless communication to BIG KAISER App.

Features ▶ P.32/34/36

EWE, Ø 25 - 203	437
EWN, Ø 20 - 203	439
EWB, Ø 32 - 105	446
EWB-AL, Ø 100 - 203	446
EWB-UP, Ø 25 - 100	447

Smart Damper Boring Heads



Anti-vibration boring bars.

Features ▶ P.40/41

BBT Smart Damper	94
BDV Smart Damper	143
HSK Smart Damper	193
Smart Damper Extensions	253
SW Smart Damper	385
EWN Smart Damper	438

Large Diameter Boring Tools



Lightweight tools
Ø 200 - 3 000 mm.

Features ▶ P.38

Series 318, Ø 200 - 620	455
Series 318, Ø 620 - 3 000	462

Indexable Inserts

Specially selected inserts for boring operations.



Indexable Inserts	470
CBN/PCD Inserts	487
Inserts for Turning	492
Grooving Cutters	495

Fullcut Mill

FCM and FCR type

Super smooth cutting with low cutting force.



Features ▶ P.48/49

FCM Integral Type	518
FCM Cylindrical Type	525
FCM Arbor Type	527
FCR Integral Type	531
FCR Cylindrical Type	536

Surface Mill

Unique design face mill cutter.



Surface Mill	541
--------------	-----

Indexable Insert Drills



CK Shank	546
----------	-----

C-Cutter

Extensive chamfering range.



Standard Type	551
CKB Type	551
Universal Type	552

C-Cutter Mini

Ultra high feed chamfer mill.



Features ▶ P.50

Multi Insert Type	555
Single Insert Type	556
Bolt Hole Type	558
Spot Facing Type	559
CKB Type	560
Universal Type	560

R-Cutter

Automated R-chamfering.



Features ▶ P.51

Front and Back Chamfering	563
Front Chamfering	564
CKB Type	565

C-Centering Cutter

Efficient centering and chamfering with carbide insert.



Features ▶ P.51

C-Centering Cutter	567
--------------------	-----

Center Boy

Center and chamfer in one.



Center Boy	568
------------	-----

BF-Cutter

Back spot facing tool for cap screw hole.



BF-Cutter

570

Slot Milling Cutters



Cylindrical Type
CK Type
Arbor Type

572
572
572

Edge Detector

3D and 2D touch sensor detecting work position.



Point Master
Accu Center

576
587

Tool Offset Sensor

Magnetic tool offset sensor.



Base Master
Tool Master

579
581

Alignment Tool for ATC

For re-aligning ATC arm and machine spindle.



BT/DV Shank

582

Dyna Test

Precision measuring tools of the highest quality for machine tool maintenance.



Features ▶ P.53

BBT Shank
BDV Shank
HSK Shank
BIG CAPTO Shank

584
584
585
585

Machine instruments

For machine maintenance.



Dyna Force
Dyna Contact

583
586

Level Master

2-axis simultaneous detection leveler.



Features ▶ P.54

Level Master

587

Centering Tool for Lathes

Easy centering for lathes with static dial gauge.



Features ▶ P.47

Centering Tool for Lathes

588

The Original Simultaneous Taper and Flange Fit Spindle System for Steep Taper



The BIG-PLUS® spindle system exceeds all other interface concepts thanks to simultaneous taper and face contact between machine spindle and tool holder. Furthermore the system offers full interchangeability with existing machines and tool holders.

In a first step a taper contact is resulting during entering the tool into the machine spindle. Due to the pull-in force the tool taper expands the spindle in the elastic range. The tool is pulled further into the spindle until the tool flange reaches the surface of the spindle nose.

Advantages

- Improved surface finish & dimensional accuracy
- Extended tool life
- Prevention of fretting corrosion caused by heavy cutting
- Improvement of ATC repeatability
- Elimination of Z-axial movement at high speeds
- Improved roundness of boring operation

Basic concept

The BIG-PLUS® Spindle System is based on the most current available standards in JIS B6339 and DIN 69871.

A conventional steep taper tool holder is supported on a reference diameter called the gauge face. On the contrary, a BIG-PLUS® tool holder is supported on the flange face, which brings remarkable improvement to rigidity.

	Conventional	BIG-PLUS®
BT50	Ø 69.85	Ø 100
BT40	Ø 44.45	Ø 63
BT30	Ø 31.75	Ø 46

Increased contact diameter (example of BT50)

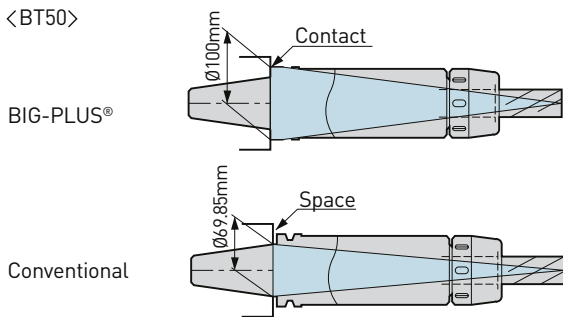

Improvement of ATC repeatability

The BIG-PLUS® spindle System assures the highest precision location of the tool holder in the spindle when using the ATC for loading tools, as a result of the dual contact which precisely positions the tool holder within 1 micron.

ATC repeatability

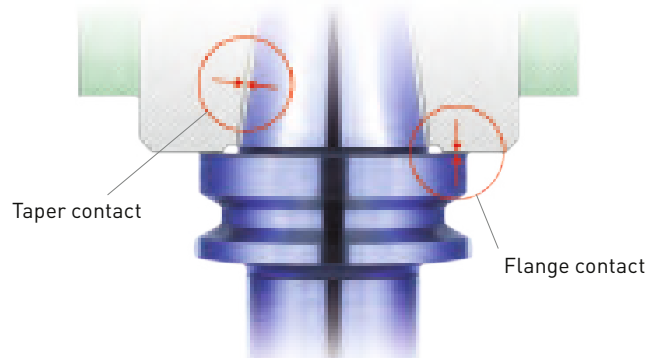
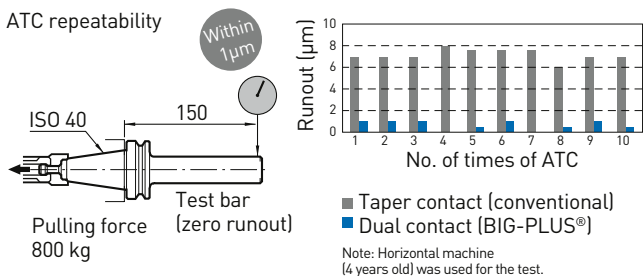

Perfect interchangeability

BIG-PLUS® tool holders can be used on existing standard machine spindles. Existing standard tool holders can also be used on BIG-PLUS® spindles. In this case, simultaneous contact cannot be attained.

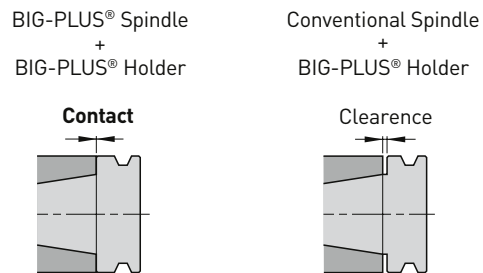

Although other simultaneous contact systems require exclusive new accessories, the BIG-PLUS® spindle uses existing accessories such as a presetter and tool holder fixture as it is based on a conventional steep taper shank. Further, it is not necessary to modify tool magazines and ATC devices of existing machines.

Existing accessories utilized

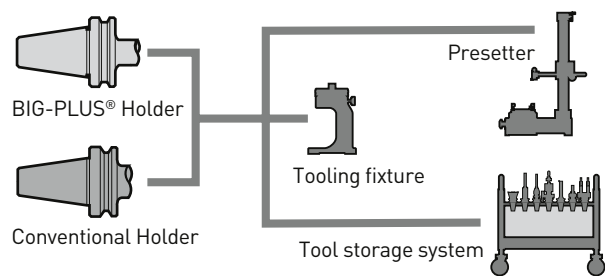



Minimized deflection for maximum machining, accuracy and superior finish

With BIG-PLUS® simultaneous contact, machining rigidity is greatly enhanced due to the larger contact diameter of the tool holder flange face. This larger face contact combined with the taper contact works together to resist deflection. With less deflection, greater machining accuracy and superior finish can be achieved.

Comparison of deflection

BT40

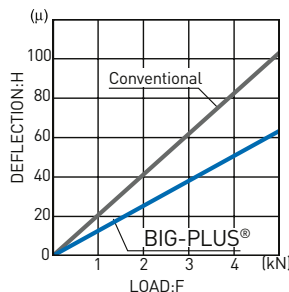
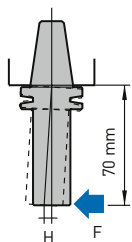

Deflection of machine spindle is included. Vertical machine was used for the test.

Caution: The Original Simultaneous Taper and Flange fit Spindle System for Steep Taper

More than 85% of not original dual contact BIG-PLUS® are not in tolerance

There are many manufacturers who claim to have dual contact tooling system: But only a few have an official license of BIG-PLUS®. Without a license, these manufacturers haven't the master gauges nor the measuring devices or the tolerances for defining the critical dimension of the distance between the taper gauge line and the tool flange. However, according to our inspection*, 85% of the tested tool holders are out of the official BIG-PLUS® tolerance. Only original BIG-PLUS® tool holders enable the benefits and strengths of a BIG-PLUS® spindle system. BIG KAISER controls 100% of its BIG-PLUS® tool holders and therefore guarantees that all products are in the tight BIG-PLUS® tolerance.

Face milling application

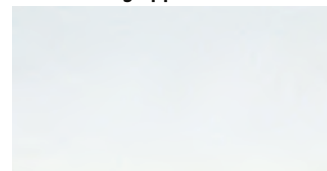

BIG-PLUS®

Standard

Machine tool:	#40 (horizontal machining center)
Cutter:	Face milling Ø 125 (6 cutting edges)
Work material:	A2017 Duralumin
Cutting depth:	2.4 mm



BIG-PLUS® is the trademark guarantee to maximize your machine capability.

* Inspection results or samples of non-licensed dual contact tooling measured according to the BIG-PLUS® standard.

HSK Tooling Systems

Selected materials and strict control of dimensional accuracy for the optimum quality. Wide range of standard holders to meet all production requirements.



Premium material selection

Since HSK is a hollow taper shank, the material has a critical role for optimum performance. BIG KAISER uses carefully selected high grade alloy steels. Particularly, BIG KAISER uses premium materials for HSK 40 and smaller where the cross section of shank taper is very thin.

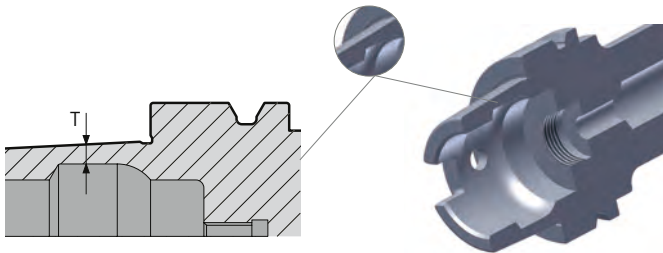

HSK Size	25	32	40	50	63	100
T	1.09	1.25	1.92	2.60	3.47	5.17

Great variety of HSK

Following HSK types are standardized to offer the best possible solution. Other types are also available upon request.

HSK-A32/A40/A50/A63/A100/A125

HSK-E25/E32/E40/E50

HSK-F63/F80M



Drive key form

HSK shanks according to form A are designed to carry out torque transmission by the round shaped key-way at the end of the taper. Because of the importance of this round shaped geometry, BIG KAISER provides finishing of this feature after heat treatment.

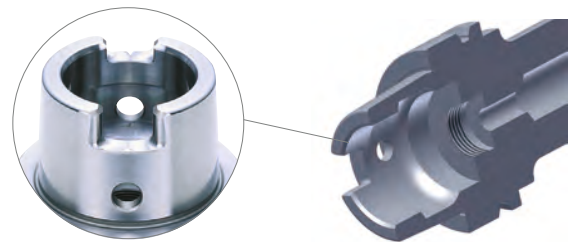

HSK turning tools

HSK-T63 / T100 (ISO 12164-3)

Unique modular type of turning system offer various solution for turning applications.



BIG CAPTO

Polygonal tapered dual contact tooling system adopted by ISO standards. CAPTO is a trademark licensed by Sandvik Coromant.



Polygonal tapered dual contact tooling system



Sandvik Coromant AG developed, in 1989, a triangular polygon shaped 1/20 taper dual contact system. BIG DAISHOWA launched licensed production in 2000. Polygon taper maintains close contact and eliminates radial clearance, making it an ideal interface for turning. ISO standardized in November 2008.

Outstanding cutting edge height repeatability

The polygon taper without clearance achieves high repeatability of cutting edge height, as well as secure function as a drive.

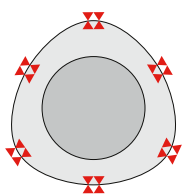

Complete Fit

Abundant rotating tool series

Collet Chuck, Milling Chuck, Boring Tool, Tapper, Sensor, Endmill Cutter, Arbor...

A wide range of tool holders are available.



Turning tool series ideal for millturn machines

The abundant cartridge range and revolutionary modular systems improve turning efficiency on millturn machines.

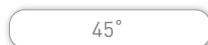

Tilt Type
SType



S Type Cartridge

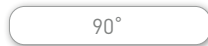
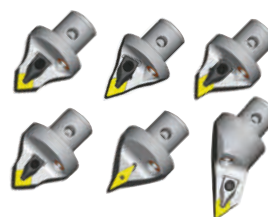

Right Angle Type
F Type Pat.



F Type Cartridge



BIG CAPTO's C3 and C4 series for Turning is now available

NEW

MEGA Chuck Serie



Precision ground and balanced for high speed machining

MEGA Chucks are micro mirror ground finished on all surfaces to assure perfect concentricity for high speed machining. The drive keyway is machined after heat treatment.

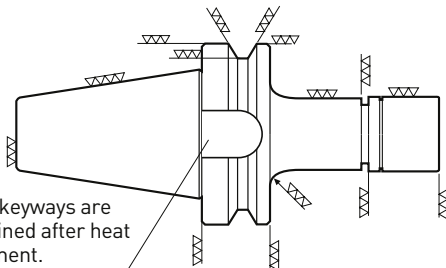

Drive keyways are machined after heat treatment.

Notch-free design MEGA NUT prevents vibration and reduces noise

Vibration at high speeds is eliminated with the use of notch free designed nuts, which offer superior balance and concentricity.

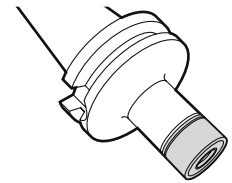

Perfect quality control



All tools are marked with serial no. as a proof of a high quality and good traceability. 100% tools are inspected its quality to guarantee high performance.

Easy and firm clamping by the MEGA Wrench

The unique MEGA Wrench has a one way clutch system with roller bearings and a ratchet function which is capable of safely and evenly applying force to the entire nut periphery.



Tool identification service available



As an experienced partner for tool management solutions, BIG KAISER is ready to provide its tooling with various solutions for tool identification such as data matrix codes or ID sensors.

4 chuck types for different high speed machining requirements

MEGA Micro Chuck

For micro drills and end mills
Clamping range:
Ø 0.45 - 8.05 mm



MEGA New Baby Chuck

For carbide drills, reamers and end mills
Clamping range:
Ø 0.25 - 25 mm



MEGA E Chuck

For end mills and reamers
Clamping range:
Ø 3 - 12 mm



MEGA Double Power Chuck

For end mills
Clamping range:
Ø 3 - 42 mm



MEGA Micro Chuck

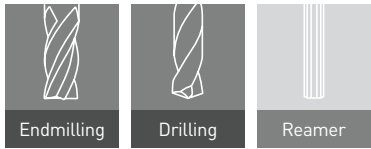

- max. 50 000 min⁻¹
- Clamping range: Ø 0.45 - 8.05
- 0.1 mm increments for higher precision

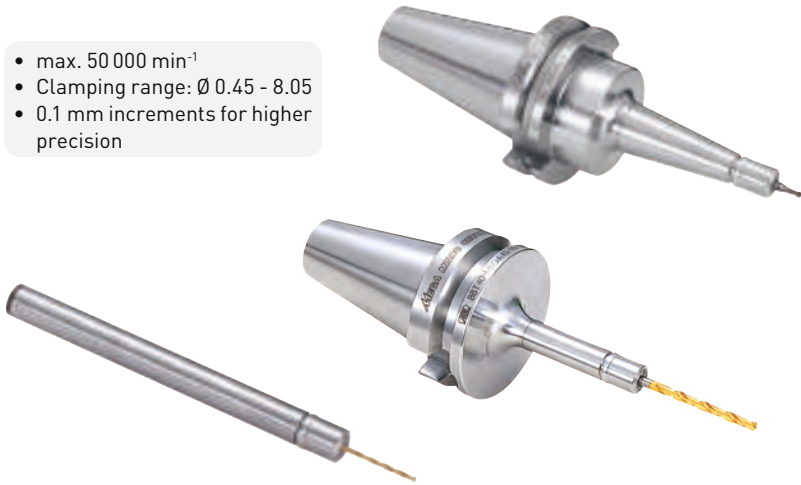

Nut diameter 10, 12, 14 & 18mm, extremely slim design

Slim design avoids interference. Ideal for small mold making combining high speed and high precision capability.

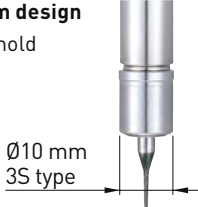

High concentricity

100% concentricity inspection. Within 1 µm at nose is guaranteed.



High precision Micro Collet

Collet concentricity

Collet class	Max. runout	
	At nose	4xD
AA	Within 1 µm	Within 3 µm

Three versions are available

Straight Type: where access is restricted

Taper Type: for increased rigidity

Cylindrical Shank Type: for increased versatility

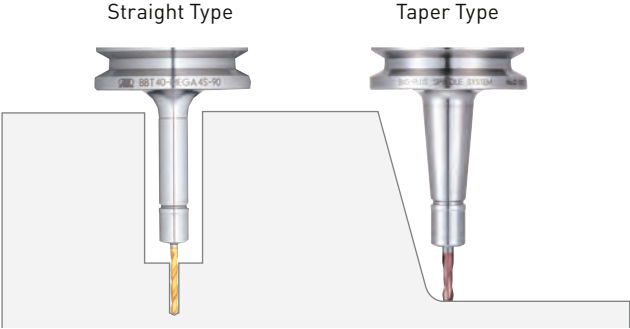

Cylindrical Shank Type

Flexible tool layout, for tighter and deeper area

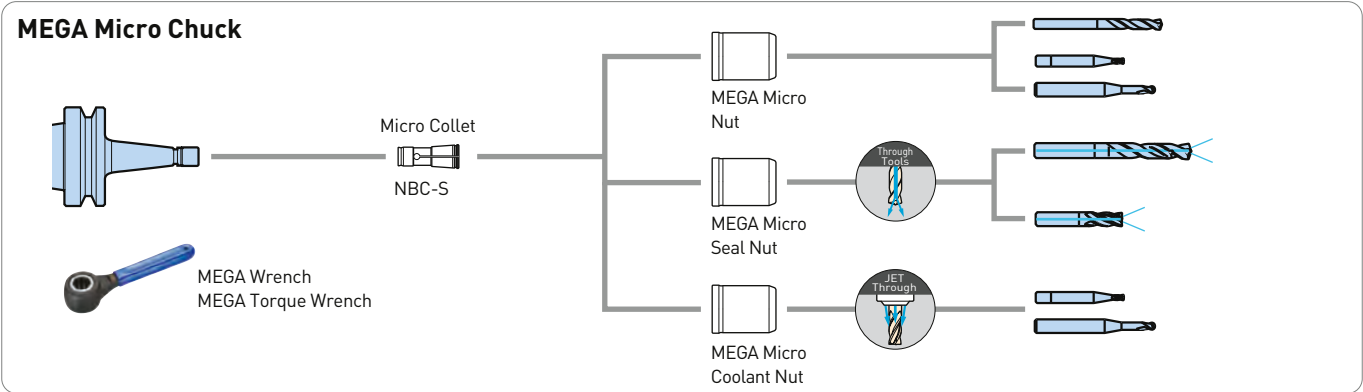

MEGA New Baby Chuck

High speed design, offered in six different size collet series, utilizes ultra precision New Baby Collets which guarantee a runout at the collet nose of less than 1 micron.

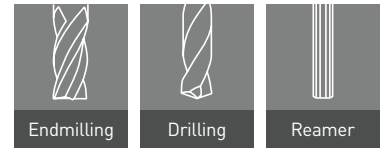

- max. 40 000 min⁻¹
- Clamping range: Ø 0.25 - 25.4

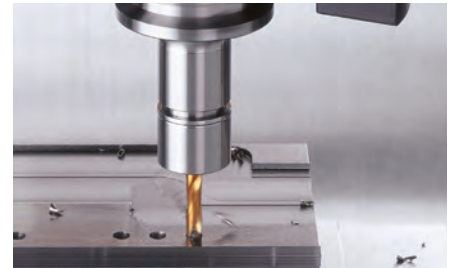

High precision collet, close to submicron

100% inspection to guarantee accuracy. Material, production, heat treatment, everything is selected for precision.



High precision NBC Collet

Collet concentricity

Collet class	Max. runout	
	At nose	4xD
AA	Within 1 µm	Within 3 µm

2 way coolant supply

Sealed collet nut MEGA Perfect Seal

- Standard NBC Collet is used
- High dust resistance
- Max. coolant pressure 7 MPa

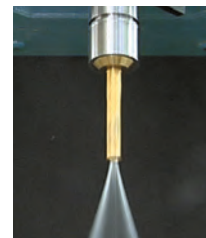

Through Tools
Tools with holes



Jet Through
Tools without holes

Various collet and nut selection

Various type of collet and nut can bring the best solution for your demand.

NBC Standard
For general



NBC-E collet
For end mill



FONBC collet
For coolant-through tools



MGN nut
For high speed



MPS nut
For efficient coolant supply



MEGA New Baby Chuck

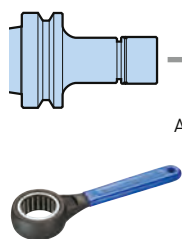

MEGA Wrench
MEGA Torque Wrench

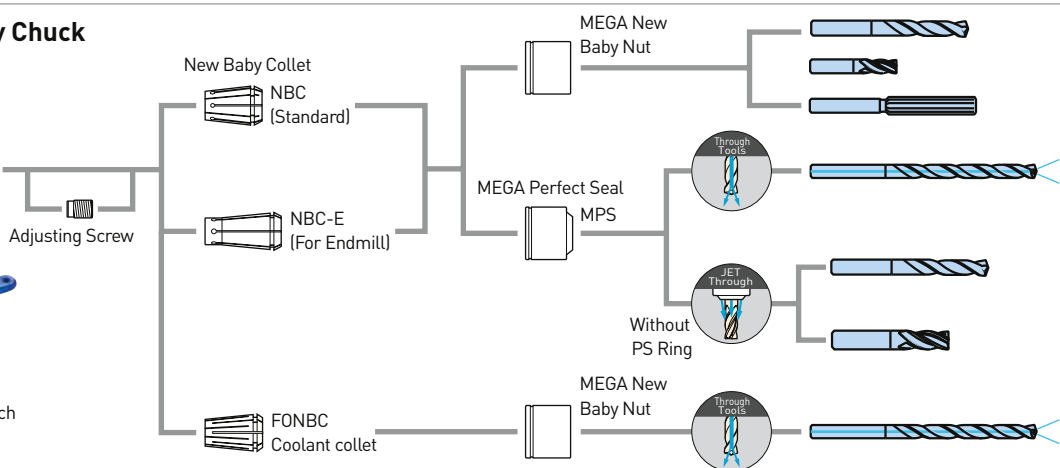

MEGA E Chuck

Collet chuck designed exclusively for endmilling up to \varnothing 12 mm with high concentricity and rigidity.

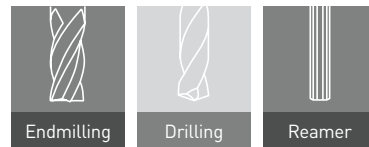

- max. 40 000 min⁻¹
- Clamping range: \varnothing 3 - 12



High concentricity

100% inspection to guarantee accuracy within 1 μ m runout at collet nose.



High precision MEGA E Collet

Collet concentricity

Collet class	Max. runout	
	At nose	4xD
AA	Within 1 μ m	Within 3 μ m

Substantial and tapered body design

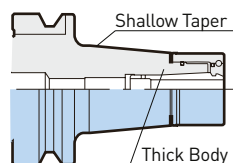

Thick body eliminates chatter and deflection. Tapered extension provides the rigidity to prevent vibration.

Slit-through coolant

Coolant is reliably directed to cutting surface through slits in the collet. Tool life is extended together with improved surface finish as a result of smooth chip evacuation.

- Max. coolant pressure 7 MPa



High grip collet

Gripping force is an important element for endmilling with a collet chuck. The long gripping length of the collet in the MEGA E series provides a powerful gripping force. The shallower taper of the collet improves concentricity in order to achieve better surface finishes and longer cutting tool life.

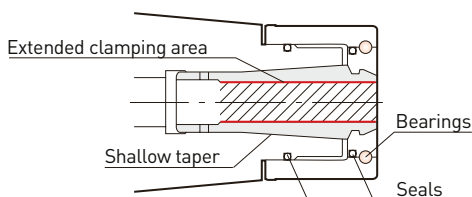

For coolant-through tools

Sealed collet nut to supply coolant reliably through cutting tool.



MEGA E Perfect Seal



Ideal for burnishing drills and reamers due to extended gripping length.

MEGA E Chuck

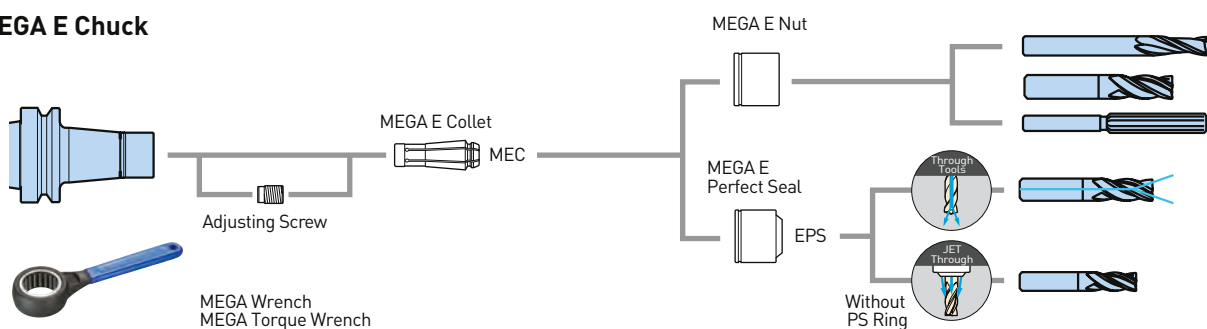

MEGA Double Power Chuck

Flange contacting nut and simultaneous taper & flange contact assure highest rigidity.

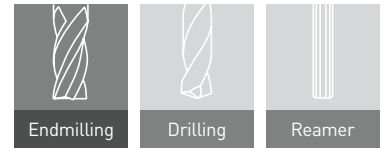

- max. 30 000 min⁻¹
- Clamping range: Ø 3 - 42
- Ideal for solid machines



Stabilizing contact between flange and nut provides exceptional rigidity

The expanded contact diameter of the nut of the MEGA Double Power Chuck to the flange provides the highest rigidity as if the chuck and nut were one solid piece. This superior rigidity assures heavier duty machining without chatter.

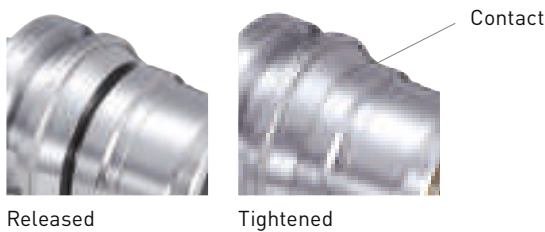

Secure coolant supply

Two types are designed for the most effective coolant supply.

- Improved surface finish
- Extended tool life
- Smoother chip evacuation
- Cooling & lubrication of tools



Type D through tools



Type DS jet through

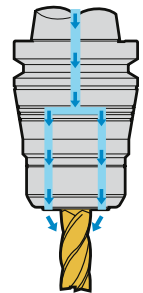

Cutting conditions

Coated carbide endmill Ø 32, 4-flutes Workpiece: SS400 (JIS) V282 m/min S 2 800 min ⁻¹ F1 120 mm/min	BBT50-MEGA32D-105	Other manufacturer (L = 90)
	Radial d = 14 mm Power 15.2KW	Radial d = 9.5 mm Power 9.2 KW

Various type of straight collets are available.

For jet through
PJC collet



For through tools
PSC collet



For through tools
OCA collet



MEGA Double Power Chuck

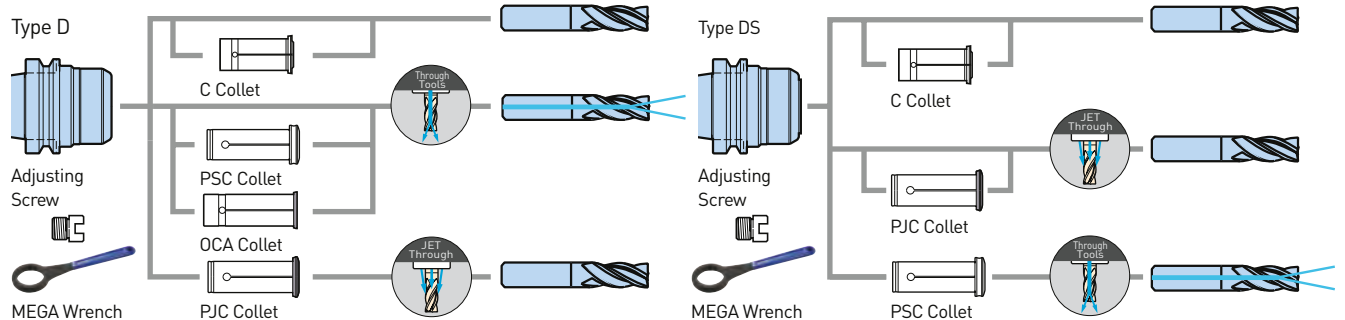

MEGA Perfect Grip

Features 100% security against pulling out the cutting tool under any torque load.

- Accepts industry standard Weldon flat milling cutters
- No special grinding of milling cutter required
- Flood jet-through coolant
- Available with BBT40/50/DV50 and HSK-A63/100/125



Non-Pullout mechanism

The Key Grip engages in the groove of the chuck body to ensure no tool pullout.

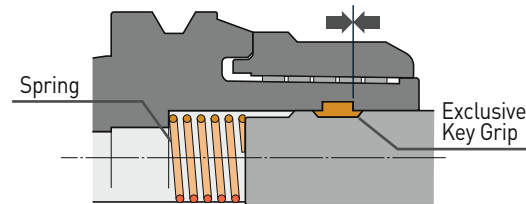

Simple, easy handling with secure clamping

1. Place the exclusive key grip into the Weldon flat of the end mill shank.
2. Insert the end mill with the key grip in alignment with one of the three key grip grooves inside the milling chuck.
3. Rotate the end mill approximately 20° clockwise until the key grip stops securely against the stopper pin.
4. Finish clamping the tool until the clamping nut contacts the positive stop of the chuck body.

Non-Slip mechanism

The Key Grip maintains contact with the stopper pin to prevent any slip under high torque.

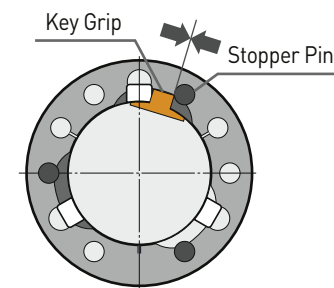

Flood jet-through coolant

The key grip grooves provide channels for high volume coolant to the cutter. Effective end milling of HRSA's requires a high volume of coolant to the cutting edge to dissipate heat and aid in the removal of chips.



Perfect contact between flange and nut

The expanded contact diameter of the nut of the MEGA Perfect Grip to the flange provides the highest rigidity.



Released



Tightened

Hydraulic Chuck

Ultra precision hydraulic clamping chuck holder with various additional features.

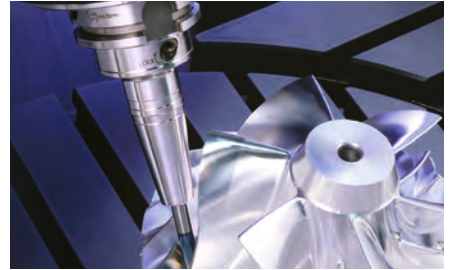

Runout accuracy less than 3 μm

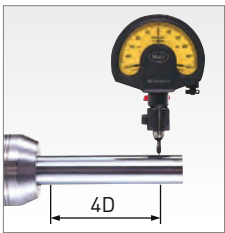

High precision runout accuracy less than 3 μm at 4d improves the workpiece surface finish and extends tool life.

Easy clamping with 1 wrench



The cutting tool can be clamped or unclamped easily and securely with just 1 wrench. Extremely good repeatability and runout accuracy are guaranteed.

Integral sleeve construction

Compared with the traditional two-part construction sealed with O-rings, BIG KAISER Hydraulic Chucks are long lasting and maintenance free. Also the rigidity is greatly improved by the short projection length and dual pressure points.

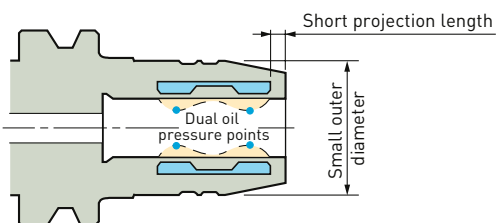
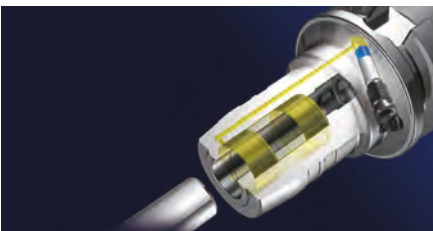

Complete sealing mechanism prevents oil-leaks

Specially selected material and shape of the hydraulic plunger seal prevents leakage of oil and decrease in gripping force. The complete seal design avoids minute cutting particles of graphite or ceramics from entering into the toolholder. This enables usage on tool grinding machines.



Jet through

Coolant hole at nose supplies coolant.

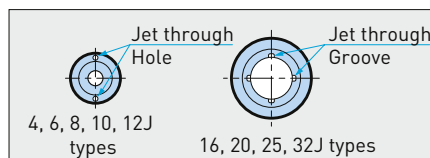

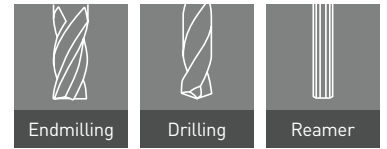

Super Slim Type

Slim design eliminates interference. Ideal for high precision 5 axis machining.



Tip diameter
Min. \varnothing 14 mm
Max. 60.000min⁻¹
(HSK-E25)



HSK-E25/E32/E40/E50/F63 series

Ultra-compact and high precision.
Hydraulic chuck suitable for small machining centers.



Prebalancing
0.5g·mm or less
(HSK-E25)



Super Slim UP series

Amazing runout accuracy within 1 μ m at 4D.
The ultimate precision hydraulic chuck.
HSK-E25/E32/E40 Type

NEW



1 μ m
ULTRA PRECISION

UP

Jet Through Type

Securely supplies coolant or oil mist to the tool periphery.
Delivers outstanding results with high accuracy finishing in 5-axis machines.



Tip diameter
Min. \varnothing 20 mm
Max. 35.000min⁻¹



HDC4J to 12J models allow jet through to be switched to center through by assembling the accessory plug.

New Baby Chuck

New Baby Chuck is capable of achieving high spindle speeds as required for drilling and end milling with smaller diameter cutting tools.

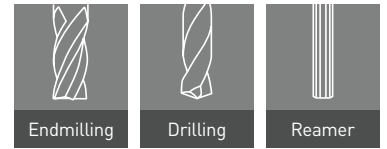

- Clamping range: \varnothing 0.25 - 20



Ideal combination of taper angle and collet projection length

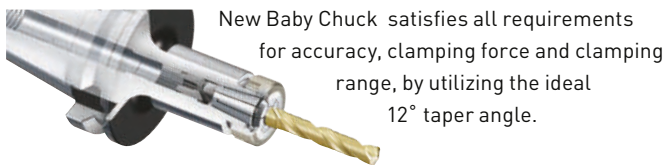

New Baby Chuck satisfies all requirements for accuracy, clamping force and clamping range, by utilizing the ideal 12° taper angle.

For high pressure coolant supply

- Standard NBC Collet is used.
- High dust resistance
- Max. coolant pressure 70 bar

High concentricity

Each collet is inspected and double checked to meet maximum runout tolerance permitted.

Collet concentricity

Collet class	Max. runout	
	At nose	4xD
AA	Within 1 μ m	Within 3 μ m

The nut is a key to achieve the highest precision of a collet

- Since the threads greatly influences accuracy, they are finished after heat treatment. Therefore, bad influence from clamping action is eliminated, which enhance clamping performance.
- A nut incorporates a thrust bearing with steel balls that prevents stress to a collet and allows a smooth clamping force to a collet.

Runout adjustable RA holder

Simple structure allows for easy adjustment of runout accuracy. Compensates for increased runout of machine tool spindles caused by extended use.



Tool edge runout: 2 μ m or less

- Uniform hole diameter
- Improved surface roughness
- Increased tool life



Through Tools
Tools with holes



Jet Through
Tools without holes

New Baby Chuck

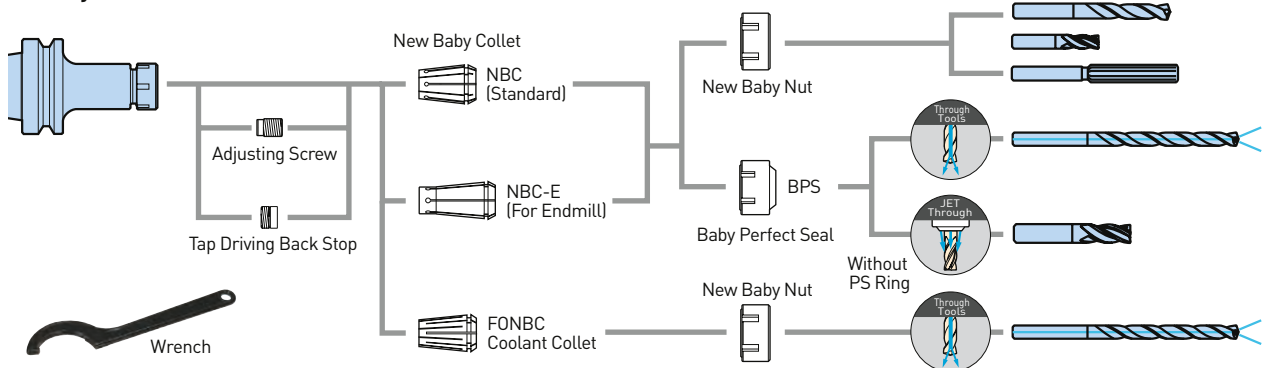

New Hi-Power Milling Chuck

New Hi-Power Milling Chuck combines the high accuracy with high torque capability and rigidity.

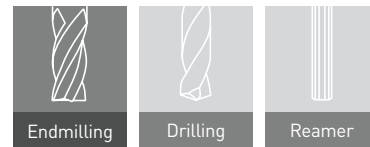

- Clamping range: $\varnothing 3 - 42$



Secure and reliable slit design

The annular section needs to be substantial in order to provide rigidity but retain the ability to collapse in order to provide sufficient grip. The section of the Hi-Power Milling Chuck has combined holes and slits at regular intervals in order to combine both requirements.

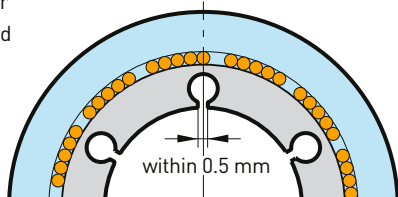

Precise concentricity

Concentricity is assured by the integral design and clamping by mechanical compression of the annular section by the rolling bearing system. All models are inspected and double checked to meet maximum runout tolerance permitted. (within $10\mu\text{m}$ at 4D).

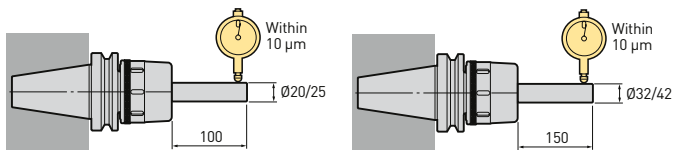

Basic tool for various applications

New Hi-Power Milling Chuck is a good basic tool. Not only for milling tool, but also for boring tools, chamfering tools and various applications.

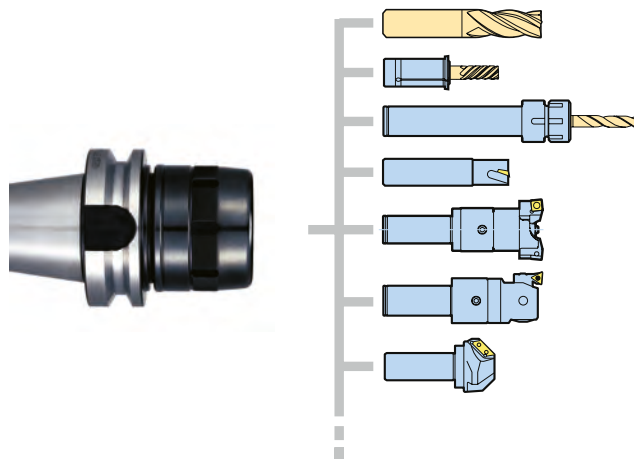

Runout adjustable RA holder

Simple structure allows for easy adjustment of runout accuracy. Compensates for increased runout of machine tool spindles caused by extended use.



Tool edge runout: $2\mu\text{m}$ or less

- Consistent hole diameter
- Improved surface roughness
- Increased tool life

HMC12J type

Clamping diameter: $\varnothing 12$. A nut shape slimmer than collet chucks.

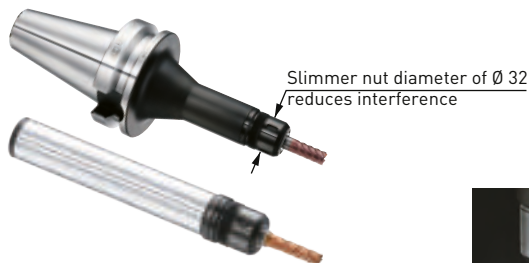

New Baby Collet Chuck

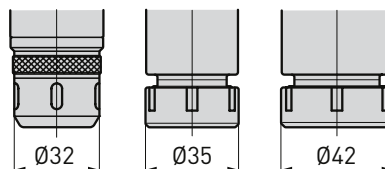

Peripheral coolant supply to cutting edge

CK Boring Tools

CK Boring is the most reliable and accurate modular boring head in the world. By using the unique modular connection, from Ø 2 mm to over Ø 200 mm can be covered by a combination of 7 main bodies and various Rough and Fine Boring head.



Simple but reliable CK connection

The CK is a simple method for securely and powerfully clamping flange faces with a single wrench. Moreover, even if the same boring head is repeatedly attached and removed, the cutting edge position does not vary by more than 2 microns. This accurate clamping allows boring diameter setup to be done with a boring head only, increasing the machine utilization and drastically reducing labor.

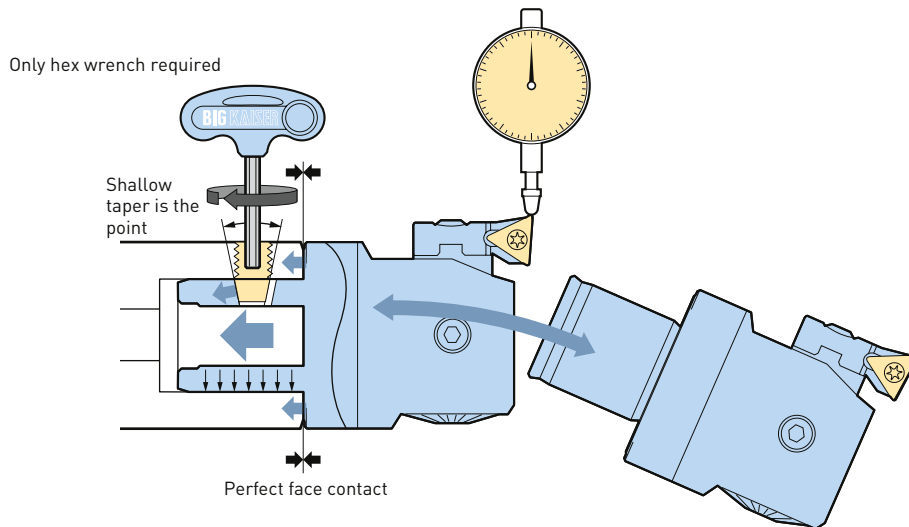

The cutting edge position does not vary by more than 2 microns, no matter how often the same head is inserted.

CK, CKB, CKN in one system

To offer the most suitable solution, 3 different types of CK connections are available depending on the application and main body. "CK" is the original KAISER modular system. "CKB" has the floating cross bolt, which is automatically centered in the trapezoid-shaped recesses in the mating part and ensures to transfer the torque force. "CKN" is the 3-screw-connection with 3 partial slits. It is ideal for light weight and high performance tools.

Interchangeability overview

		Male connection (Boring Head, Extension, Reduction)		
		CK	CKB	CKN
Female connection (Shank, Extension, Reduction)	CK	+	-	+
	CKB	+	++	+
	CKN	+	+*	++

++ = Best match + = Match - = Doesn't match

1. CKN female connection products are delivered only with 1pc CK screw and 2pcs blind screws assembled.
2. CKN male connection products are delivered with 2pcs CK screws.
3. * Some CKB male products in the large Boring program do not fit with CKN female connection.

CKB

CKB connection: highly efficient and easy to handle

The modular components are clamped with the lateral locking screw (CK-screw). The floating cross bolt is automatically centred in the trapezoid-shaped recesses in the mating part and ensures an absolutely uniform distribution of the torque forces.

- Simple, efficient operation -no special equipment or tools needed
- Maximum rigidity due to high preloading forces and large contact surfaces
- Precise cutting edge location even when using several adapters
- High interchange accuracy, maximum radial change error is 0.002 mm

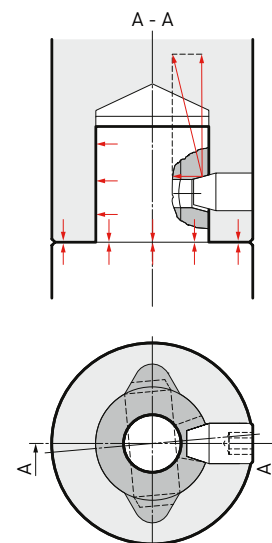
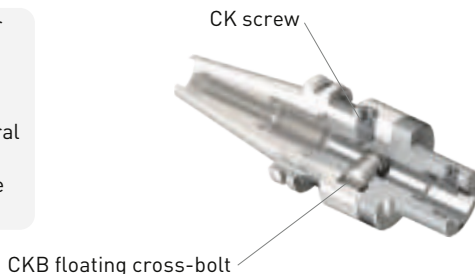

CKN

CKN Connection: Lightweight Program

The double connector coupling enables the use of aluminium extension tubes which result in a considerable weight reduction for larger tools. The torque transmission from the aluminium tube to the connector made of steel over three screws guarantees no reduction of cutting performance in comparison to tool combinations made of steel only.

Double connector coupling Connector with partial slits



Extension tube aluminium

Extension tube aluminium

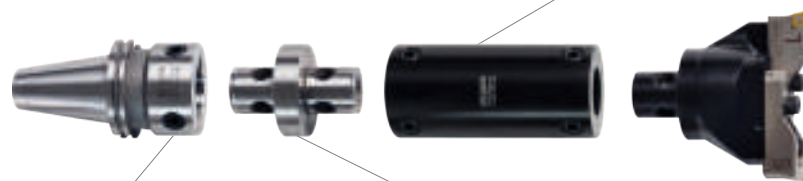

Shank CKB/CKN compatible

Double connector couplings

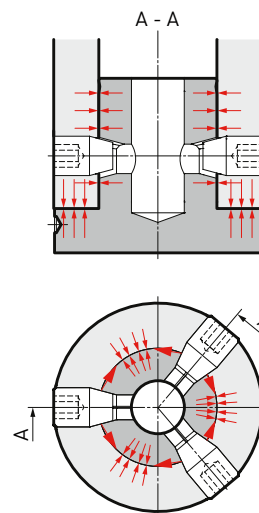

All components with recess for the CKB floating cross-bolt

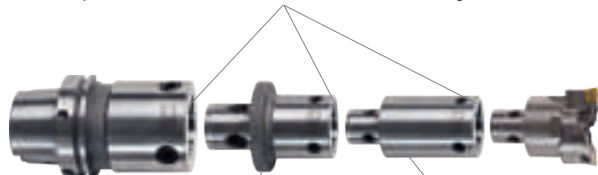

Reduction CKN7 x CKN6

Extension CKN6 x CKN6

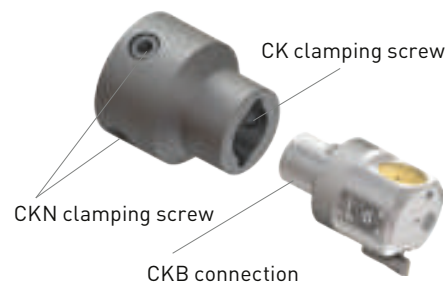

CK Boring Heads Overview

CK Boring is the most reliable and accurate modular boring head in the world. By using the unique modular connection, from Ø 2 mm to over Ø 200 mm can be covered by a combination of 7-main bodies and various Rough and Fine Boring head.

Roughing

Adapted for both balance and step cutting by simply changing positions of standard Cartridges. (for blind holes)

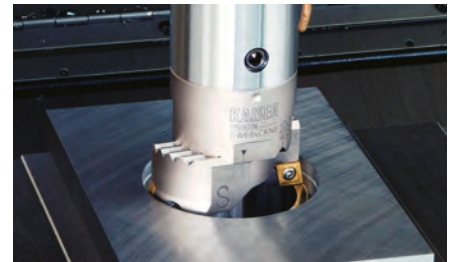
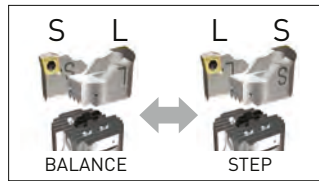

- High rigidity SW boring head**
- Ø 20 - 203 mm
 - Serrated for high connection rigidity



- MW boring head**
- Boring tool for small-diameter 2-flute roughing.
- Ø 16 - 21 mm
 - Versatile Ø 20 shank
 - Spiral groove for improved chip evacuation

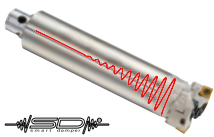

- Smart Damper**
- Roughing Head with Built-In Damper. SW Boring Head.
- Smart Damper with SW head
 - Closely adjacent vibrating point and damper achieve a high damping effect.

Finishing with Insert Holder Type

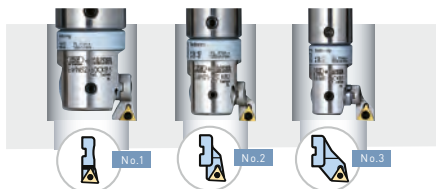

Emphasis on chip evacuation properties
Replacing the insert holder makes it possible to secure sufficient clearance for chips.



Back boring available as standard. Supports back boring by simply reversing the insert holder.



- EWN boring head**
- Prebalanced design/Multifunction head
- Ø 20 - 203 mm
 - Prebalanced design supports high-speed boring
 - Abundance of insert holders



- EWB boring head**
- High speed
- Ø 32 - 105/Ø 100 - 203 mm (Aluminum)
 - 0.01mm/Ø scale
 - Built-in automatic precision balancing unit
 - Vc Max. 2 000m/min.

Lightweight
special aluminum head 600/800g



- EWE boring head**
- Digital boring head with wireless communication
- Ø 41 - 203 mm
 - Digital display allows the adjustment amount to be read at a glance
 - Fully waterproof and dustproof structure (IP69K equivalent)



- EWN Smart Damper**
- Built-in damper
- Integrated EWN Boring Head and Smart Damper.
 - Closely adjacent vibrating point and damper achieve a high damping effect.

Display Resolution 1µm/Ø

Finishing with Cylindrical Bar Type

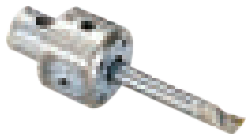

EWN boring head

- High precision
- \varnothing 1 - 54 mm
 - 0.01mm/ \varnothing scale plus 1 micron vernier
 - Combine with carbide shank for stable deep-hole boring



EWN 04-7/04-15

- World's smallest precision boring head
- \varnothing 1 - 7/ \varnothing 1 - 15 mm [EWN 04-7]
 - O.D. \varnothing 18.5 ultra-compact design
 - Max. 30 000min⁻¹



EWE boring head

- Digital boring head with wireless communication
- \varnothing 1 - 54 mm
 - Digital display means the adjustment amount can be read at a glance
 - Waterproof and dustproof structure (IP69K equivalent)



Display Resolution 1 μ m/ \varnothing



EWB boring head

- High speed
- \varnothing 1 - 50 mm
 - 5 μ m/ \varnothing precision diameter adjustment
 - Built-in manual precision balancing function
 - Max. 16 000min⁻¹

For Large Diameter 318 series

New safe mechanism

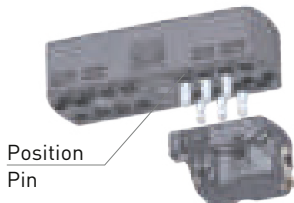

Position Pin

Using the position pin fastens the head or clamp base to the slide. Prevents the head from flying off due to high-speed rotation caused by programming errors.

Aluminum high speed Type

- Lighter weight for greater speed.
- Uses hardened aluminum components, tough yet lightweight. (Slide/Clamp Base)
- Vc Max. 2 000m/min.

Center through supported

- Reliable coolant supply to finishing and roughing cutting tool peripheries.



Rough boring head

- For Roughing
- \varnothing 200 - 3 000 mm



Finish boring head

- For Finishing
- \varnothing 200 - 3 000 mm
 - Precision head with outstanding operability.
 - Back boring available.
 - Available in analogue and digital

Pin Turning



- \varnothing 0.5 - 2 856 mm
- Realizes finishing accuracy not possible with contouring.



Accessories



Various shanks/accessories. Combine with a CK Shank for a wide range of applications not limited to boring.

CK Extension



CK Shank

Smart Damper

Built-In Damper

- Unique dynamic damper eliminates chatter.

EWE Digital Fine Boring Heads

The boring heads EWE with digital technology combine all advantages of the analogue boring heads EWN. Thanks to the large display with a resolution of 0.001 mm Ø bores with extremely tight tolerances can be machined.



Peripheral Models

EWE peripheric cutting heads have a large work range as different insert holder types and sizes are available, including trough and blind holes and back boring application types.

Fine boring heads EWE and EWN feature equal boring ranges and body dimensions and allow the use of the same accessories.

- Boring range: Ø 25 - 203



EWE 68



EWE 25

Digital display with a resolution of 0,001 mm Ø



Automatic switch off function which always stores the last displayed value and integrated power management for optimized battery life.

Piezo button for maintenance-free use.

Direct measuring diameter allows corrections in both directions

With a direct electronic measuring system on the tool carrier and a resolution of 0.001 mm Ø, the fine boring heads EWE enable diameter corrections with an unmatched accuracy.



Body protection grade: IP 69K

The high quality coating of the tool body ensures a complete protection against corrosion. The built in electronic is safe from dust and high pressure spray water according to the protection category IP69K.

Large boring range

Every EWE has a large work range due to three different insert holders. For example: The EWE 68 can manufacture a diameter range from Ø 68 to 150 mm.

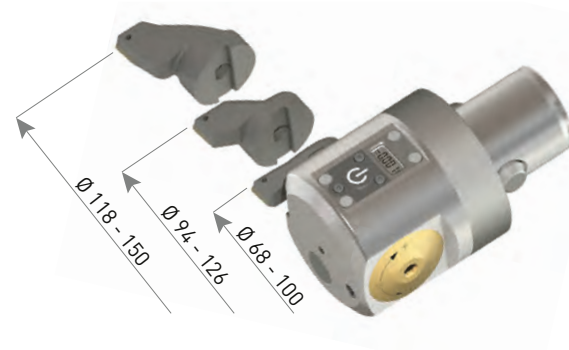

EWE Reader



If no Smart Phone or BIG KAISER App is available, the EWE Reader is the perfect alternative for making settings on the digital fine boring heads. The EWE Reader shows the adjustment on the fine boring head quickly and easily and simplifies machining.

EWE Digital Fine Boring Heads



Centric Models

Fine boring heads EWE with digital display and direct electronic measuring system on the tool carrier, feature absolute setting accuracy. The boring heads are designed for ultra precise boring operations in the range from Ø 2 to Ø 152 mm with highest spindle speeds.

Same accessories for fine boring heads EWE and EWN.

- Boring range: Ø 2 - 152



EWE 2-152



EWE 2-32

Body protection grade: IP 69K

The high quality coating of the tool body ensures a complete protection against corrosion. The built in electronic is safe from dust and high pressure spray water according to the protection category IP69K.

Digital display with a resolution of 0,001 mm Ø and Piezo button



Automatic switch off function which always stores the last displayed value and integrated power management for optimized battery life.

Piezo button for maintenance-free use

Electronic components – made by BIG KAISER

All electronic components are entirely developed and manufactured in the electronic lab of BIG KAISER in Switzerland. Before shipping, every digital boring head is calibrated and tested separately.

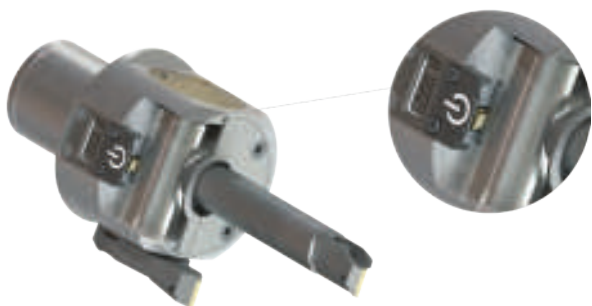

Integral execution available

Can be used for cylindrical bar from dia 2-80 and with peripheral insert holders from dia 80-152mm.



EWE 2-152 HSK-A63

Maximum rotation speed: 14 000 min⁻¹

Tool carrier in center position allows n max. of 14 000 min⁻¹ due to minimized imbalance.

Variable length adjustment of the tool holder

Best cutting results are only reachable if the tool holder is as short as possible. The EWE features variable length adjustment of the tool holders which ensures the shortest and therefore the most rigid tool assembly.

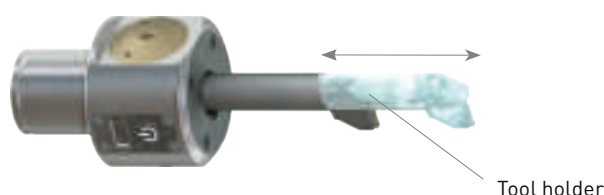

Tool holder

EWN Fine Boring Heads

The EWN heads feature highly accurate and smooth micrometre adjustment precision. Vernier precision allows exact corrections of 0,001 mm and a repeatability of 0,0005 mm. Carrier movement is strictly radial, avoiding parallax shift and making corrections even more precise. The locking system prevents any diameter shift, even under tough cutting conditions assuring best surfaces technically obtainable.

Periferical Models

The fine boring heads EWN series 310 cover a range of $\varnothing 20 - 203$ mm with only 7 fine boring heads. Due to the optimized balance over the whole adjustment range, cutting speeds up to 1 200 m/min are permitted.

Fine boring heads EWN and EWE feature equal boring ranges and body dimensions and allow the use of the same accessories.

- Boring range: $\varnothing 20 - 203$



EWN 53

Back boring

Insert holder can be mounted in opposite direction for an easy changeover to back boring.

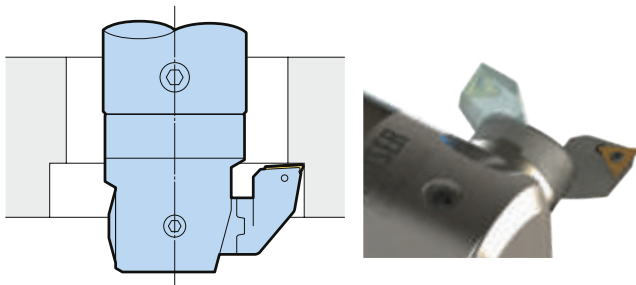

Versatile tool

Insert holders for many types of inserts (TP, TC, CC with different angles) as well as accessories for face grooving are available.



Large boring range

Every EWN fine boring head has a large work range due to three different insert holders. For example: The EWN 68 can manufacture a diameter range from $\varnothing 68$ to 150 mm.

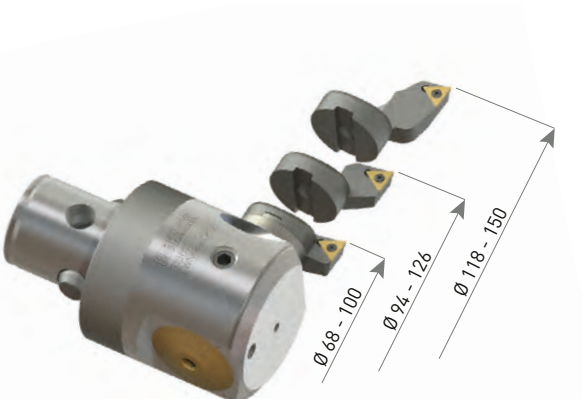

Suitable with outer diameter turning system

Fine boring heads EWN/EWE are suitable for OD turning applications in the diameter range $\varnothing 16 - 2856$ mm. There are two different OD turning systems available.

$\varnothing 16 - 120$ mm

$\varnothing 49 - 2856$ mm

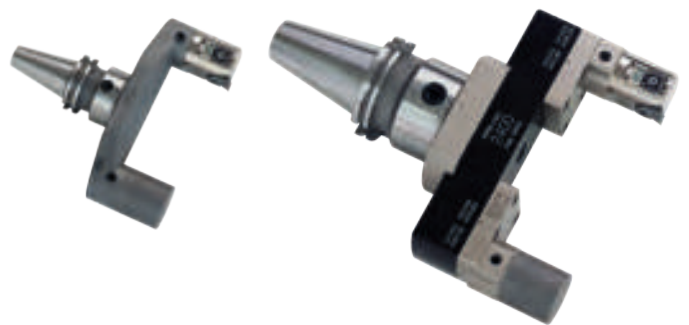

EWN Fine Boring Heads

Centric Models

Fine boring heads with centric boring bars in modular and integral execution for accurate, high performance boring operations.

Same accessories for fine boring heads EWN and EWE.

- Boring range: \varnothing 0.4 - 152



EWN 2-152



EWN 2-32

EWN 04-22



EWN 04-15

EWN 04-12

EWN 04-7

Variable tool length adjustment of the tool holder

Best cutting results are only reachable if the tool holder is as short as possible. The EWN features variable length adjustment of the tool holders which ensures the shortest and therefore the most rigid tool assembly.

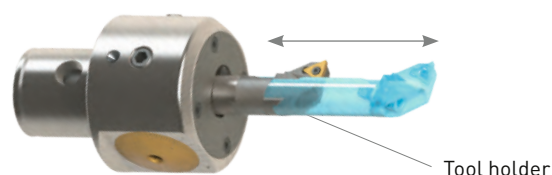

Tool holder

Fine balanced when tool carrier is set in center position

Tool holders made of carbide with adjustable insert holders permit diameter setting on the insert holder. The heavy tool holder remains in the center position and does not create any imbalance. The imbalance created by the insert holder is in most cases insignificant.

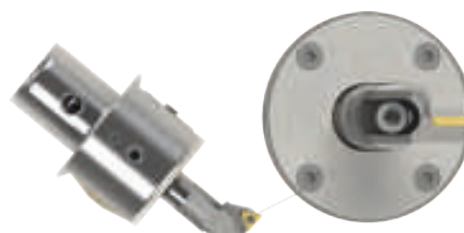

Large dial disc for a parallax-free reading

Thanks to the use of a vernier, diameter adjustments of 0.001 mm can be executed precisely.

Many integral executions available

In addition to the boring heads with CK-connection integral executions of the EWN 2-152 are available for DV, HSK, BT and BIG CAPTO spindles.

EWN 2-152: Huge boring range with just one tool

Additional boring range with peripheral insert holders from \varnothing 80 - 152 mm.

\varnothing 2 - 54 mm

\varnothing 54 - 80 mm

\varnothing 80 - 152 mm



EWB Balanced Fine Boring Head

The precision balancing of the EWB with peripheral insert holder occurs automatically by the adjustment of the diameter. The EWB with centric boring bar is precisely balanceable via a balancing ring. To balance the whole tool combination there are prebalanced shanks and components available. Even at max. speeds, balanced tools guarantee vibration-free boring, resulting in increased productivity and highest precision.

- Max. speed: 2 000 m/min



EWB 41

Ready to work

The EWB fine boring heads will be delivered with assembled insert holder.

Aluminium executions available



The fine boring heads EWB-AL are made of high tensile aluminium with hard coating. Together with reductions and extensions made in the same way, the weight for long and large diameter tool combinations is reduced by more than 50%. This means that weight problems during ATC and handling are eliminated.

Self balancing mechanism

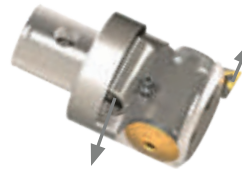

A counterweight built into the boring head compensates for the imbalance caused by the movement of the tool carrier.



EWB 2-50

Variable length adjustment of the tool holder

Best cutting results are only reachable if the tool holder is as short as possible. The EWB features variable length adjustment of the tool holders which ensures the shortest and therefore the most rigid tool assembly.

Boring bars made of carbide

For optimized cutting results dedicated boring bars made of carbide are available.



EWB 2-32

Precisely balanceable

The EWB fine boring heads have an integrated balancing mechanism. The imbalance of the boring head is compensated by a unique manually adjustable balancing ring.

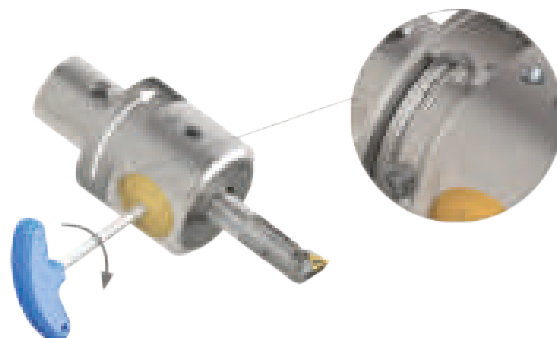

SW Rough Boring Heads

The short and compact design of the components combined with a positive and friction locked connection between the tool body and insert holders provide maximum rigidity and highest cutting performance.

- Boring range: Ø 20 - 203



SW 68

Accessories for different applications

On the same body insert holders for back boring, chamfering or face grooving can be mounted.



Precise presetting

Presetting of the tool diameter and length without presetter thanks to fixed tool length and diameter scale.



MW Rough Boring Head

Small and powerful rough boring head: The MW comes with cylindrical shank and permits extremely fast roughing of small holes. Carbide shank type is also available.



SW AL: Aluminium executions available

The rough boring heads SW AL of BIG KAISER set new standards for high performance roughing. The short and compact design of the components combined with a positive and friction locked connection between the tool body and insert holders provide maximum rigidity and highest cutting performance. Moreover it is more economical than circular interpolation milling when you have to execute deep bores. The rough boring heads are available in the sizes from SW 68 AL up to SW 148 AL.



BALANCE/STEP cut: Simply switch insert holders

A tool body with supports for insert holders of different heights, and insert holders of different lengths, provide an unmatched versatility to the new roughing tool. Without changing any components and without length adjustment, two different roughing methods, the rotationally-symmetrical-roughing (RSS/BALANCE) and the double offset roughing (DVS/STEP), can be executed.

RSS/BALANCE



DVS/STEP



Series 318 Large Diameter Boring Tools

The series 318 is based on aluminum extension slides of different lengths, which support a variety of aluminum and steel components for roughing and finishing tool assemblies. The mounting components are pinned to fit onto specific locations on the slides, and secured with steel bolts. The precise positioning of the components on the slide along with incremental adjustment scales for insert holders permit diameter and length setting without a tool presetter.

• Boring range: Ø 200 - 620

• Boring range: Ø 620 - 3 000



DV40 and HSK-A63 up to 340 mm

Even on machines with smaller spindles the series 318 can be operated.



Innovative construction

Coolant supply through all components directly to the cutting edge. High strength and hard coated aluminium, and nickel coated steel components for scratch resistant and rust protected surfaces.

Versatile system

Series 318 is for various applications such as rough boring, fine boring, OD turning, and face grooving.

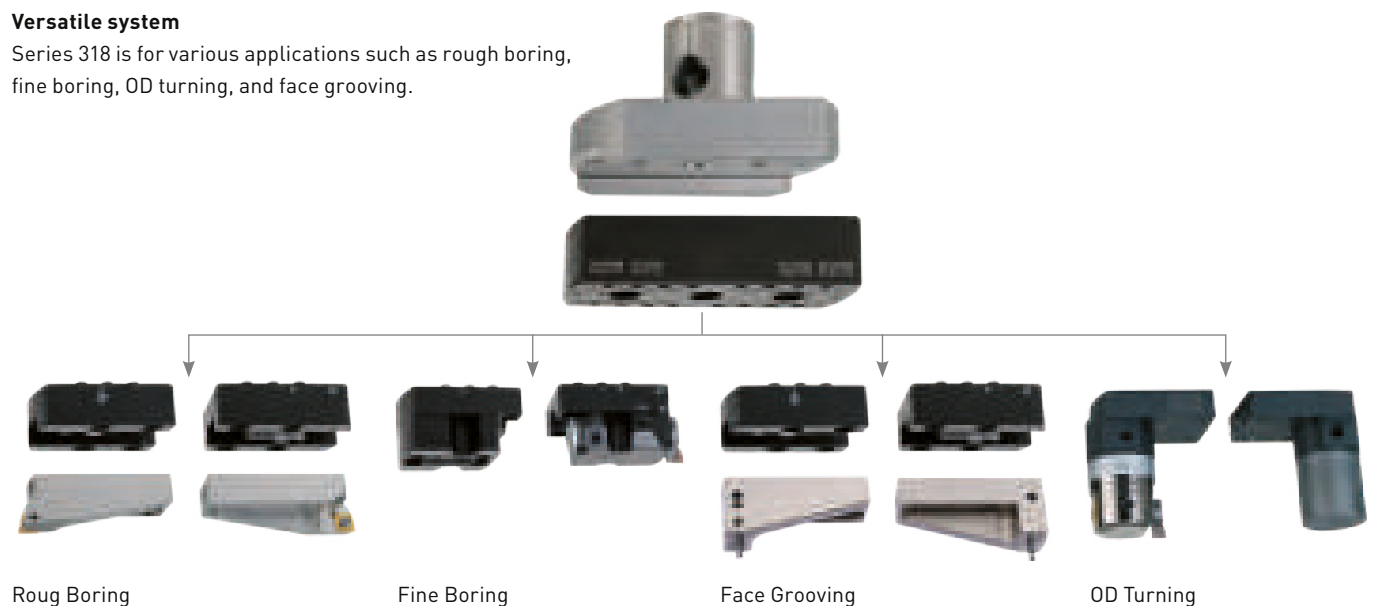

MOLD Chuck

Interference-free tool layout is available without special equipment with just one wrench. A side lock holder in a class above the rest with superior balance and BIG-PLUS® effect.



- Max. 15 000 min⁻¹

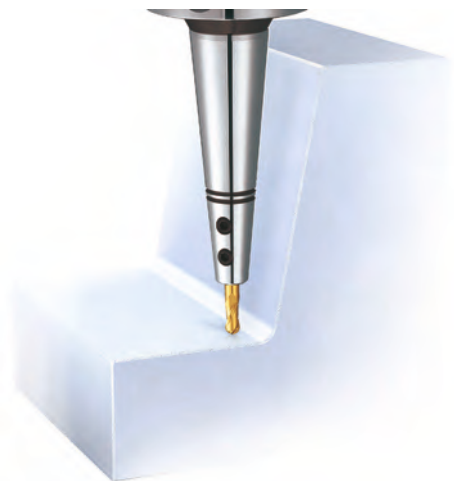

Runout accuracy within 5µm

2-flute ball endmills achieve a runout accuracy within 5µm. Both easy handling of side lock holder and high accuracy are realized.

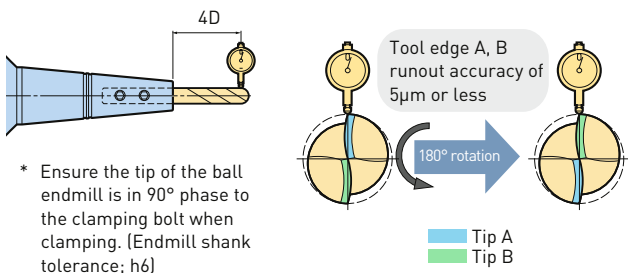

Slim and tapered design minimizes interference

Interference is minimized with mold making. Also useful in machining draft angles of molds.

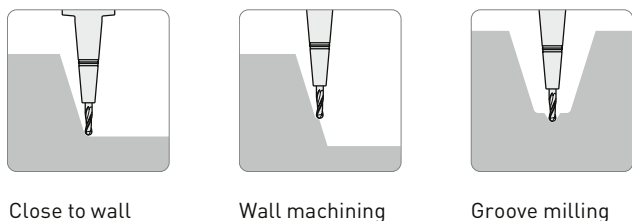

Balanced design realizes high speeds

With the entire outer diameter precision ground, stable machining is realized at high speeds.

Secure coolant supply to tool periphery

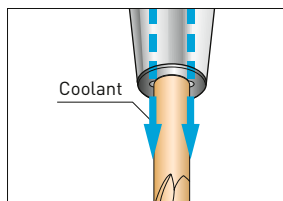

Center through coolant or oil mist can be ejected through the two coolant slits, allowing for a secure supply of coolant to the cutting edges. This helps in machining hard materials.

Smart Damper Series

Unique dynamic damping system eliminates vibration for higher productivity.



- Unique damping system for milling and boring
- Center through coolant supply



Damping mechanism

Smart Damper incorporates unique damping mechanism functioning both counter and friction dampers. Patent-pending counter weight maximizes effect of the friction damper. Vibration is absorbed effectively and higher machining accuracy is achieved.

Chatter suppressing mechanism

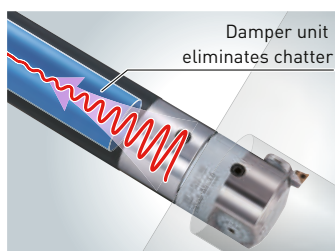

An incorporated unique damper that functions as both a counter damper and friction damper. Patent-pending counter weight maximizes effect of the friction damper. Chatter is absorbed effectively and higher machining accuracy is achieved.

Comparison of oscillatory waveforms

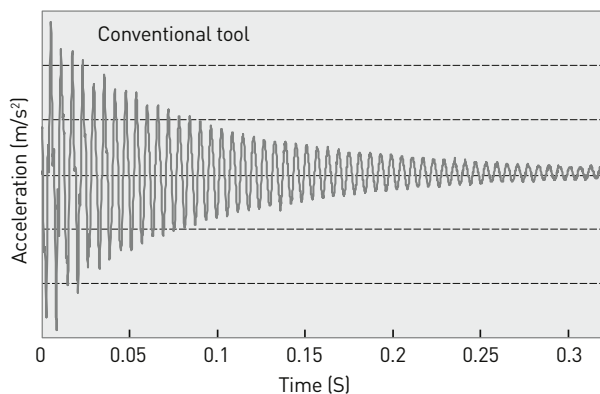
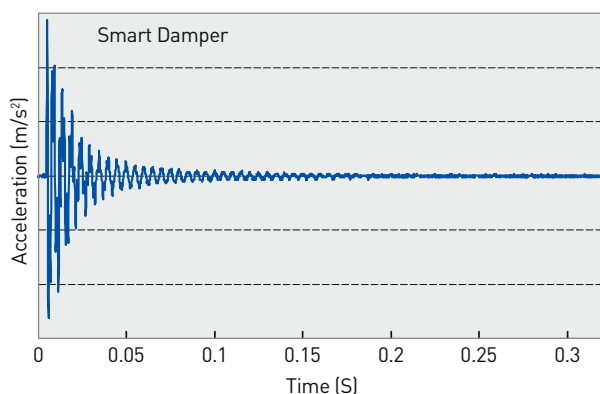

Face milling of C55 with high feed cutter

Holder	Radial depth of cut (mm)				Condition
	5	10	20	30	
Standard Holder	○	X	X		 V=90 m/min Fz=1.0/tooth Ap=2.0 mm Overhang=347 mm
Smart Damper	○	○	○		

Smart Damper achieves 6x deeper depth of cut.

Super finish surface with tough condition

Fine boring of ductile cast iron (FCD500) with horizontal MC BIG-PLUS® BBT50

Holder	Cutting speed (m/min)				Condition
	25	50	100	150	
Holder without damper	○	X	X		 Dia=Ø68 mm Depth=408 mm (L/D=6) Insert radius=R0.4 Feed=0.2 mm/rev Depth of cut=0.3 mm/Ø
Built-in Damper Smart Damper BBT50-CK-6DP-451	○	○	○		

X = Chattering ○ = Good ◎ = Excellent surface finish

6 times greater productivity. Superior surface finish and better tool life due to increased cutting speed.



CK Boring Series with Built-In Damper

High-efficiency deep hole finish boring is available

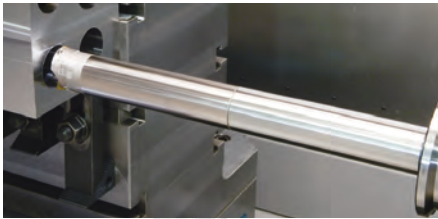

EWN Fine Boring Type

Boring head with a built-in damper. The EWN Boring Head functions are maintained, featuring integrated damper.

SW Rough Boring Type

Boring head with a built-in damper. Damper located closer to the cutting edge provides greater damping effect.

CK Shank Integral Type

A damper is built into the CK Shank. L/D = 6x

CK Extension Type

Just combine it with your standard CK Boring Head/ CK Shank to achieve damping countermeasures.



Highly reliable scale plate with vernier scale enabling 1-micron adjustment.

Smart Damper Face Mill Arbor

Replaceable damper head enables use on various basic holders.

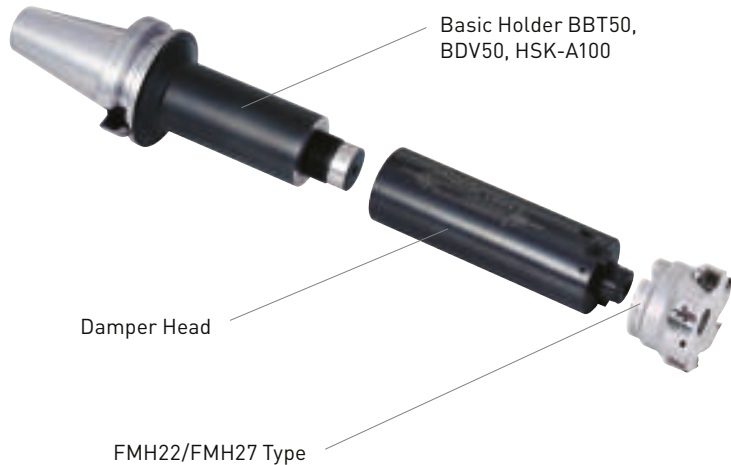

Basic Holder BBT50, BDV50, HSK-A100

Damper Head

FMH22/FMH27 Type

Combination examples BBT50

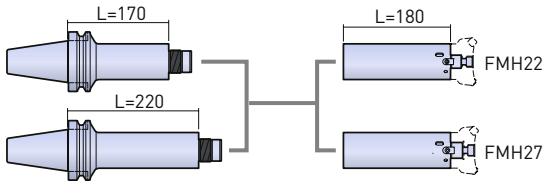

Smart Damper Turning

Newly developed for boring applications on turning machines. It performs perfectly in both roughing and finishing. Several cartridges are available for ISO insert, depending on the application.



Cartridges can be exchanged according to the application (ISO insert).



MEGA Synchro Tapping Holder

Compensates for synchronization errors during rigid tapping. Improves thread quality and tool life by reducing thrust loads caused by synchronization errors up to 90%.

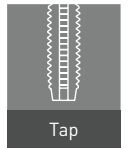

- Tapping range: M1 - M36

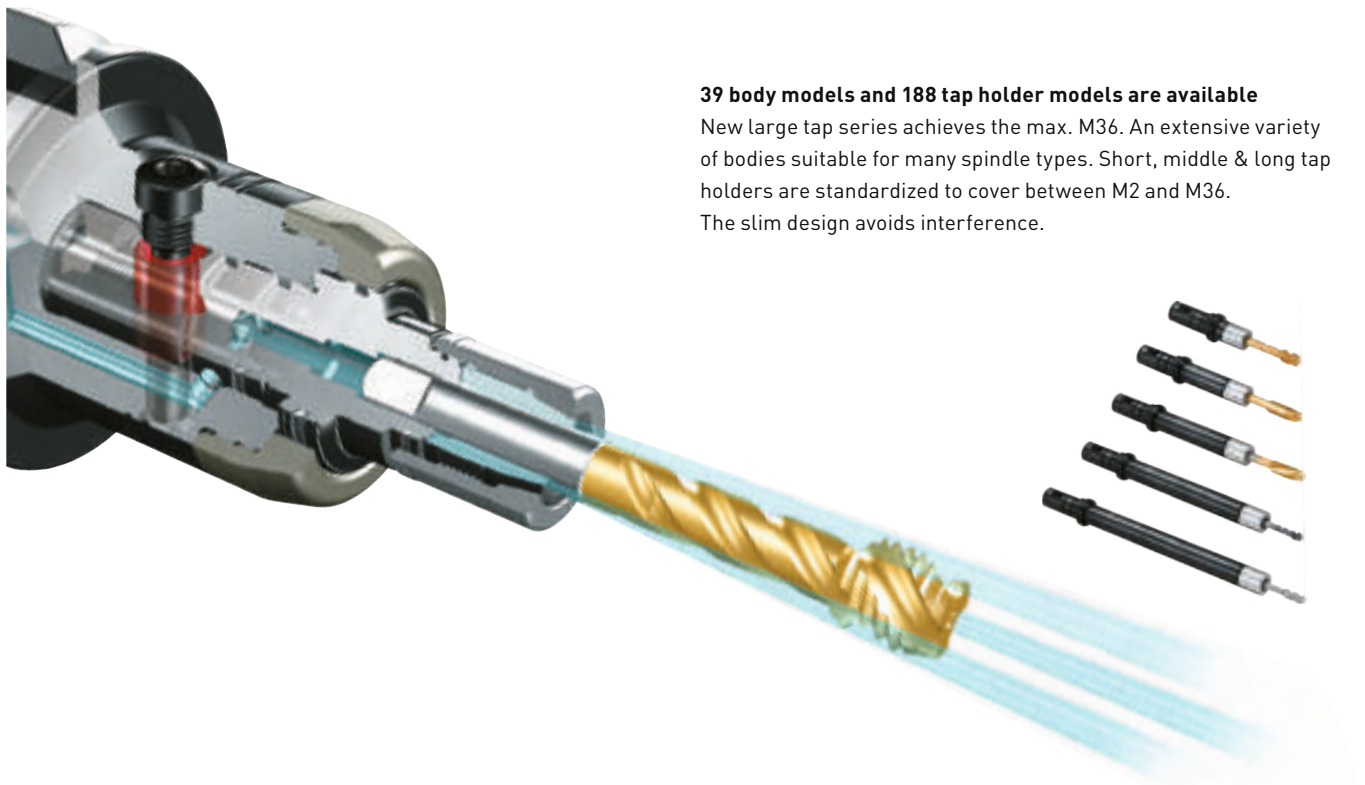

39 body models and 188 tap holder models are available

New large tap series achieves the max. M36. An extensive variety of bodies suitable for many spindle types. Short, middle & long tap holders are standardized to cover between M2 and M36.

The slim design avoids interference.



Tool periphery
Coolant is supplied through slits of the tap holder.



Through tool
Coolant is supplied through both the tool and the slits of tap holder.

Secure drive system

Body and tap holder are fixed with a drive key in the rotation direction as well as the square of the tap.



Coolant through center capability for all models

Coolant is supplied both through the tool and to the tool periphery simultaneously.



MEGA Synchro Tapping Holder compensates for synchronization errors with any type of tap

Minimized thrust load to both the tap and workpiece improves thread quality and tap life.

Load to tap – spiral tap

Spiral grooves on spiral tap cause loading in the reverse direction, similar to an end mill.

- M6 P1
- V: 20 m/min (1060 min⁻¹)
- Measured by Kistler dynamometer

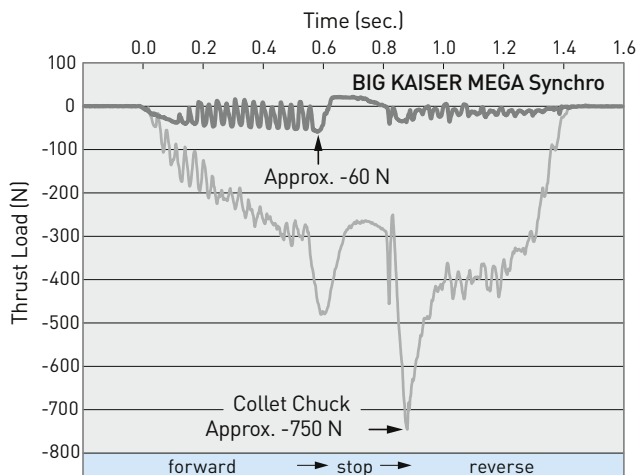
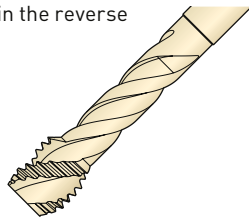

Result

MEGA Synchro reduces load to approx. 60N. This is less than 1/10th of the load compared to a collet chuck. Approx. 750N of reversal load is applied to a tap held with a collet chuck.

Comparison of surface finish

Tapping of exotic materials tends to cause a compressed burr on the thread surface. BIG KAISER MEGA Synchro compensates for synchronization errors and minimizes cutting load.

Spiral tap

M5 P0.8 Material : SNCM420(41CrNiMo2)

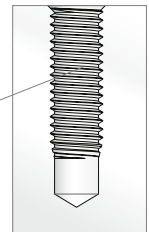
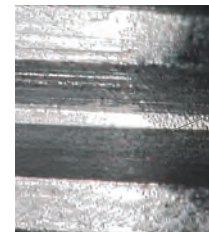
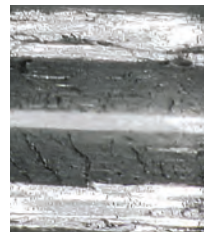

Collet chuck

MEGA Synchro

For small tap MGT3 (M1 - M3)

Eliminated synchronization errors and minimized dynamic runout. Plotted position of a test bar (at 16 mm distance on 4 mm diameter).

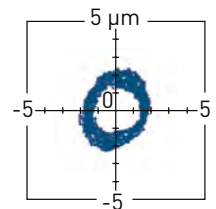

For large tap MGT36 (M22 - M36)

Smooth tapping for large tapping.



Angle Head

Angle Heads eliminate multiple set-ups, combine vertical, horizontal and angular operations on one machine. One original set-up saves time, speeds production and guarantees accuracy.

- Max. 6 000 min⁻¹
- Coolant-through from the locating pin

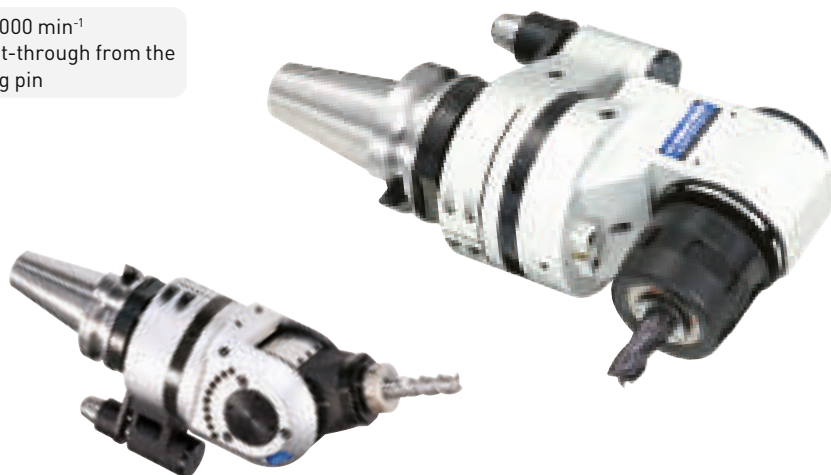

Compact design assures rigidity

Overhang is minimized for added rigidity and strength. As a result, the projection length with cutting tool is shorter, which reduces the overall load on the Angle Head and thus improves the unit's cutting capability. The minimized overhang helps to eliminate interference with the ATC and adjacent storage pockets in the tool magazine. High Rigidity S-type, which has a steel housing and a stronger locating pin assembly, is also available.

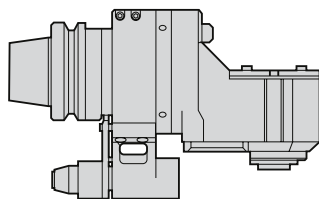

Cutter head adjustable 360°

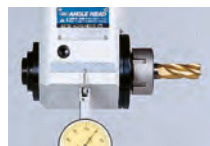

Reference faces are provided on both sides of all heads for easier setting of a cutter direction.

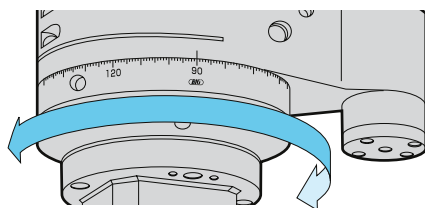
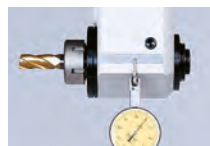

Various executions of Angle Head

More types are available to offer the best solution for your demand.

AG90 NBS type



AG90 Build-Up type



AGU type



Small bore type



Unique coolant jacket



Jacket allows coolant coming through the stop block to be efficiently directed to the tool cutting edge while simultaneously cooling the Angle Head.

Innovative sealing method



The advanced non-contact sealing method prevents coolant and particle contamination better than any other sealing method.

Superior quality components



For smooth and powerful operation and to minimize noise and vibration, all Angle Heads are equipped with hardened and ground chrome-nickel steel spiral bevel gears, super precision hardened and ground spindles, and high precision angular contact ball bearing.

Air Turbine Spindle

High-speed micro-machining can be done on a normal machining center, eliminating the need of an expensive high-speed machine.

- Max. 80 000 min⁻¹



Dynamic runout accuracy

Most problems associated with micro-machining are caused by poor dynamic runout of a machine spindle. We have established a runout measuring system that can detect spindle movement during rotation at high speed and achieved the best dynamic runout accuracy.

- Improved machining accuracy
- Superior surface finish
- Extended tool life

Plotted position of a test bar at the max. spindle speed (see image on the right).

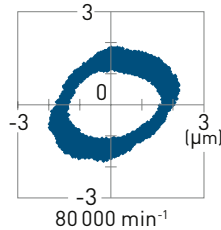

Minimal thermal displacement

Air turbine drive prevents thermal expansion of the spindle, which is essential for high accuracy micro-machining.

Axial displacement compared to operating time

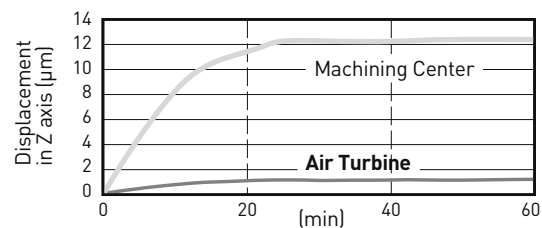

Application examples

RBX7

Aluminum A2017

Outstanding runout accuracy permits perfect thin wall cutting.

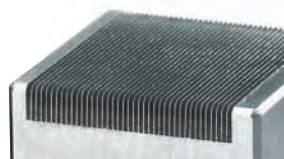

0.065 mm

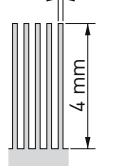
	Cutter	Ø 0.5 mm rib-endmill
	Spindle Speed	70 000 min ⁻¹
	Cutting Feed	1 500 mm/min
	D.O.C	ap = 0.02 mm

RBX5

Stainless steel SUS303

Tool life is doubled with over 1200 holes and cutting time is reduced to 1/3.

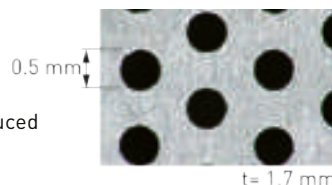

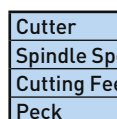
	Cutter	Ø 0.5 mm solid drill
	Spindle Speed	40 000 min ⁻¹
	Cutting Feed	20 mm/min
	Peck	0.01 mm

Automatic tool change



ATC type is available by supplying air via a stop block to enhance productivity with unmanned operation.

2 types of Air Turbine Spindle

RBX5 = 50 000 min⁻¹

RBX7 = 80 000 min⁻¹

Application Range		RBX5	RBX7
Drill	Ø < 0.1 mm	△	△
	Ø 0.1 - 0.3 mm	○	○
	Ø 0.3 - 0.5 mm	○	⊙
	Ø 0.5 - 1.0 mm	⊙	○
	Ø 1.0 - 1.5 mm	△	x
End Mill	Ø < 0.5 mm	○	⊙
	Ø 0.1 - 1.0 mm	⊙	⊙
	Ø 1.0 - 1.5 mm	⊙	△
Jig Grinding		⊙	⊙

⊙ Optimum

△ Dependent upon cutting conditions

○ Acceptable

x Not recommended for use

Hydraulic Chucks for Swiss lathe



3 types for all tool posts

Standard Type

F Type

R Type

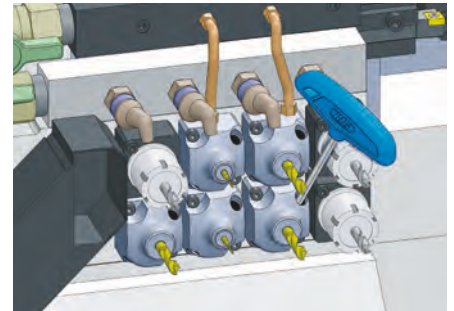
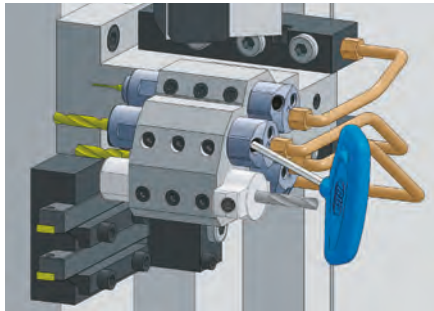
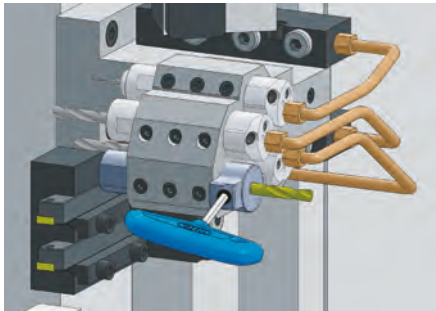

Tightening from the front side of the cutting tool. Adjustable length by cut.



Tightening from the opposite side of the cutting tool.



Easy handling of cutting tools by avoiding adjacent tools.



Structure with improved accuracy and rigidity

Based on the hydro chuck technology accumulated through milling machines for decades, the lathe type has been developed and designed from scratch. In addition to high accuracy and rigidity, a slim shape avoids interference with adjacent tools.

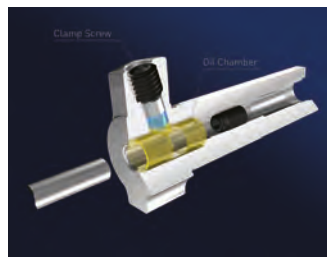

Safe and quick operation

The ability to change cutting tools with a single T-wrench drastically reduces the time required for tool change. It also reduces the need to work in extremely limited spaces and improves operator safety.



±1µm repeatability

Even changing the tool, the repeatability at 4D is stable at ±1µm or less. In addition, since the tightening is completed when the clamping screw hits the bottom, controlling tightening torque is not needed.

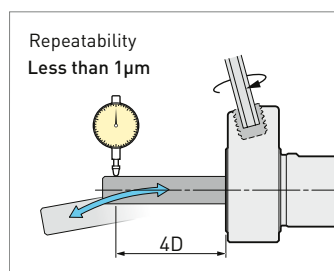

No change in tool length

Since the tool projection length does not change after the clamping, it is easy to control the tool projection length in the machine.

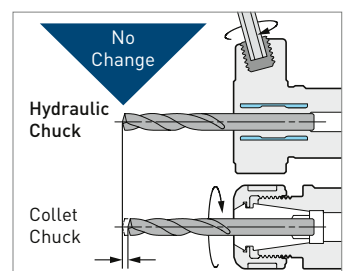

Base Master Mini

Magnetable user-friendly compact height detector for Swill lathe machines improve set up time drastically.

- Small pocket at the bottom to avoid an interference against the boss on the work piece
- Usable for all materials bigger than \varnothing 12 mm
- Minimum measurable tool \varnothing 0.1 mm
- It can be used for milling and large lathe machines



Centering Tool for Lathes

Revolutionary centering tool for lathe machines that allows the operator to fix the center very easily and quickly.

- Centering the tool holder while watching the dial gauge is possible, as the dial position is static at front
- Easy setting with fine adjustment mechanism (adjustment amount: 0.01 mm)
- Magnet base allows for flexible mounting positions

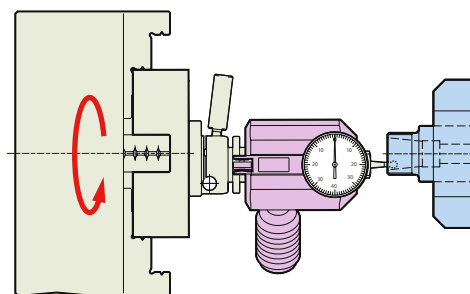

Tools for lathe machines

MEGA Micro Chuck



MEGA Synchro Tapping Holder Chuck



New Baby Chuck



MEGA ER Grip



Centering Holder



Fullcut Mill

Indexable insert endmills with both excellent sharpness and toughness, achieving the performance of solid endmills.



Sharp cutting edge by both high radial and axial rake angles

Positive high rake cutting edge for both radial and axial directions achieves smooth and quiet endmilling.

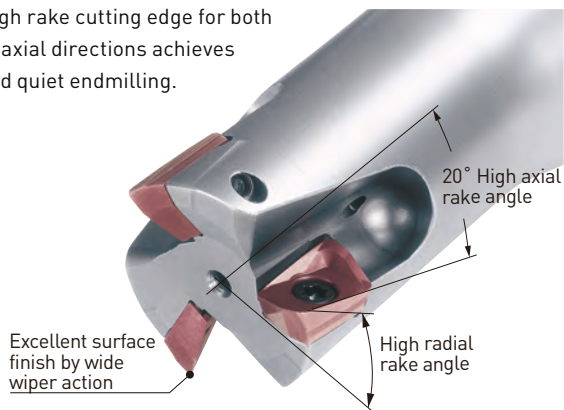

Amazing cutting performance, brought by integral design and face contact body

Integral design style with taper shank and flange contact with the machine spindle provides higher precision and rigidity thus achieving cutting conditions only otherwise available on larger machines.

Strong cutting edge reduces edge chipping

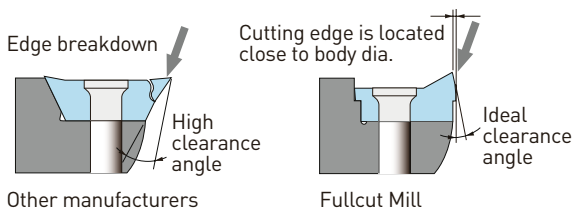

BBT and BDV type



HSK type



Contact Grip

- Threaded coupling with taper and face contact
- Resistant to chatter due to the dual contact connection
- FCM or FCR heads can be installed on the base holder

Amazing cutting performance even on #40 taper machine

Comparison of axial DOC between integral type with face contact and straight shank type. 3.6 times higher cutting performance than other manufacturer.

Cutting condition

Machine: BBT40 (BIG-PLUS®)
 Slot milling: 20 mm
 Work material: C50 (S50C)
 Spindle speed: 2400 min⁻¹
 Speed: V = 150 m/min
 Feed: 0.12 mm/tooth



Ø 16 - 32 mm

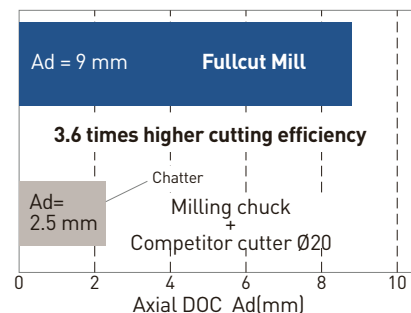

Fullcut Mill Type FCR

Unique inserts designed for ramping make multi-functional cutting possible.

- Cutter: Ø 16 - 33

Higher rigidity with integral body with dual contact system.

BBT and BDV Type HSK Type Cylindrical Shank Type



Shoulder Milling

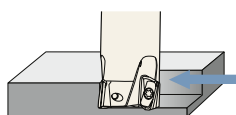

Ramping

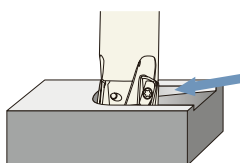

Helical Milling

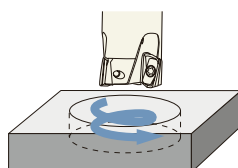

Peck-Drilling

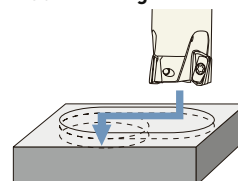

Fullcut Mill Type FCM

- Cutter: Ø 12 - 100

A variety of shanks including simultaneous fit with integral body.

BBT and BDV Type HSK Type Cylindrical Shank Type Arbor Type



Shoulder Milling

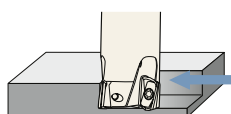

Tough cutting edge of Fullcut Mill is proven

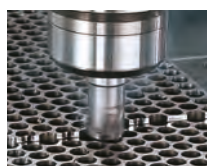

An evaluation of cutting length/life as measured when machining the most arduous workpiece by milling over a continuous series of holes. This is the condition most likely to cause edge chipping.

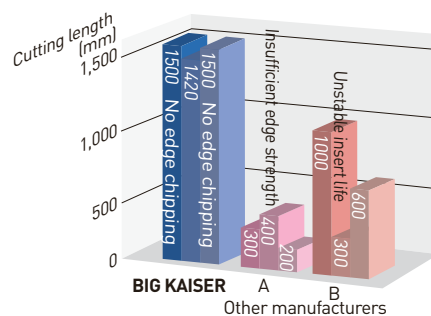

Finishing with indexable endmill - Why not?



Insert with the minimum nose radius of 0.2 mm and superb squareness to achieve high precision end milling comparable with solid carbide tools.

Work material: SUS304
 Vertical M/C: No. 40
 Cutter dia.: Ø 25 mm
 Feed: 0.12 mm/tooth

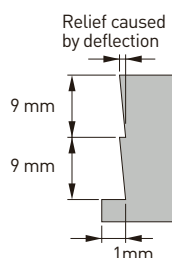

Squareness is influenced by the cutting parameters, work materials, rigidity of machine and workpiece, etc.

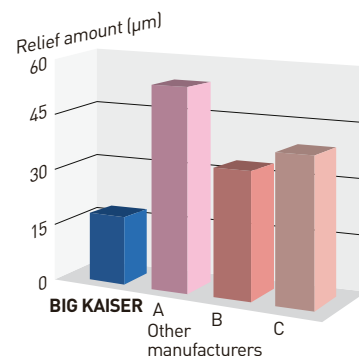

C-Cutter Mini

Compact design with 4 inserts and small cutting diameter. High performance chamfer cutter to achieve ultra high feed rate by reducing the cutting diameter to the lowest limit.

- For multi-functional cutting: chamfering, back chamfering and face milling

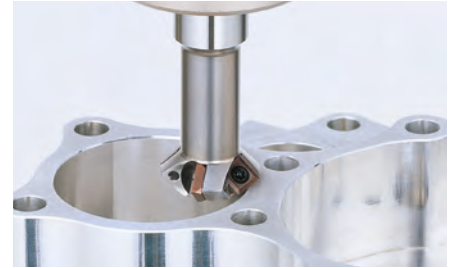

4 Inserts, small diameter and new coating achieve triple effect

1. Superb design. Ultra high feed by 4 Inserts.

Compared with 1 or 2 inserts per cutter, a 4 insert cutter multiplies feed rate.

2. Increased spindle speed by ultra compact diameter

A smaller tool diameter means faster spindle speeds.

3. Latest coating (ACP200) increases the cutting speed.

Wear resistant multi layer PVD coating increases the cutting speed.

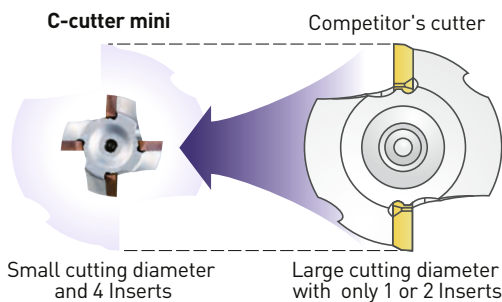

$$\text{Feed rate} = \begin{matrix} \text{Considerably improved} \\ \uparrow \\ \text{UP} \\ \text{Spindle speed} \end{matrix} \times \begin{matrix} \text{UP} \\ \text{Feed per tooth} \end{matrix} \times \begin{matrix} \text{UP} \\ \text{Number of teeth} \end{matrix}$$

$$\text{Spindle speed} = \frac{\begin{matrix} \text{UP} \\ \text{Cutting speed} \end{matrix}}{\pi \times \begin{matrix} \text{Small dia.} \\ \text{Cutting diameter} \end{matrix}}$$

World smallest hex insert

Highly-efficient back chamfering from 6 mm starting hole diameter. 3-corner insert saves cost.

Inscribed circle $\varnothing 3.31$



Versatility of the insert

Sharp cutting edge of C-Cutter mini insert make superior surface finish. The same insert can be used with BIG KAISER's original design face mill arbor, Surface Mill.



Surface Mill Rz = 1.42

Material = C50
 V = 200 m/min
 Fz = 0.2 mm/min
 Ap = 3
 Ad = 75



New series for starting hole for tapping are available from M8 to M20 range



R-Cutter

For multi-functional round chamfering for both front and back chamfering.



Excellent sharpness with new insert shape!

R-CUTTER is the first in the industry to use an insert with a large rake angle that's capable of producing clean surfaces with no vertical streaking.

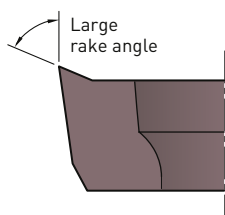

Flexible modular solution

CK extensions allow front/back chamfering of deep holes, as well as grooves or steps at the distance.

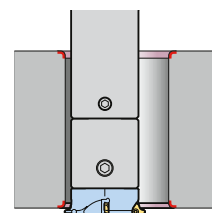

C-Centering Cutter

For centering and chamfering with a carbide insert.



Negative insert tip shape dramatically improves the life

Capable of both spot drilling and chamfering

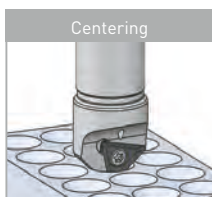
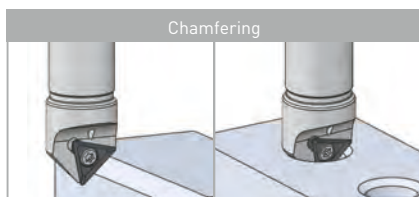

Spot drilling is not available with the 3-insert type.

Effective for traverse chamfering (3-insert type)

3-insert type with maximum chamfering width of C9. Effectively reduces machining time.

Max. chamfering width C9



Speed Finisher

Amazing improvement of surface finish at high speed cutting.

RZ = 0.55 μm with aluminum die casting ADC12

RZ = 0.67 μm with gray cast iron FC250

- Cutter: $\varnothing 50$, $\varnothing 63$, $\varnothing 80$, $\varnothing 100$, $\varnothing 125$



Quick adjustment of cutting edge height

After clamping the insert, lifting screw lifts up the insert directly by revolving the lifting nut from its side. Simple construction aids easy adjusting operation. Fine pitch thread of the lifting screw ensures precise adjustment.

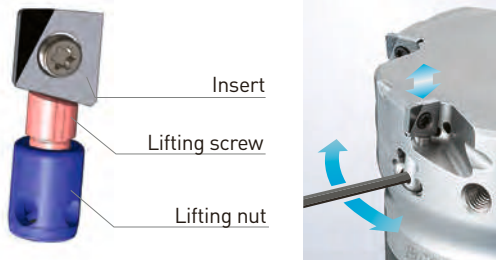

Lightweight & high rigidity

Low-profile cutter body enhances rigidity, minimizes vibration and distortion, leading to the minimized height difference of the machined surface. Lighter weight resulted from reduced mass aids performance on small machine tools such as BT30 spindle.

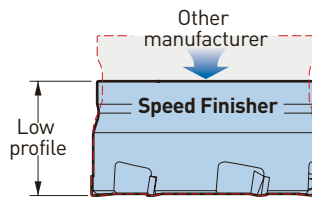

PL Presetter

Exclusive PL Presetter shortens the setup time further up to 15 sec./insert while avoiding chipping of the cutting edge.

- The cutting edge presetting is required



Secure coolant supply to the cutting edges

Coolant is supplied to the cutting edge directly in combination with the Face Mill Arbor type FMH. Especially effective to avoid built-up edges when cutting aluminum and possible re-cutting of the swarf.



Application example

(Cutter: $\varnothing 80$ mm)

Workpiece	Conditions	Surface Roughness	Height Difference	No. of Workpieces	Result
Crankcase ADC12 	Cutting speed: 4 000 m/min Spindle speed: 15 900 min ⁻¹ Feed rate: 9 550 mm/min Depth of cut: 2.5 mm	Ra=0.08 μm Rz=0.55 μm	Within 1 μm	24 000	Rough and finish processes are combined in a single operation.

Dyna Test

For maintenance and inspection of machine tool spindles.

- A machine maintenance tool of the highest quality for use as a precision measurement instrument.
- Calibration certificate and traceability diagram available upon request. (with charge)



Dyna Test

Test bar with a focus on superb quality and accuracy. Prevents trouble through the periodic inspection of machine runout accuracy.

- A high-precision test bar developed by BIG's precise machining technology.
- Periodic accuracy evaluation eliminates machining defects.
- Abundant variation to suit the standards of each holder.

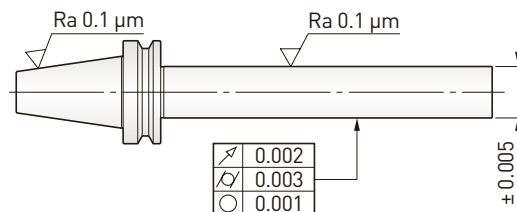

Runout	0.002 mm
Roundness	0.001 mm
Cylindricity	0.003 mm
Roughness	Ra: 0.1 μm
Diameter tol.	± 0.005 mm

Precision standard of BIG Daishowa Test Bars

BIG Daishowa provides high quality test bars, produced under a strict quality control system.

Dyna Force

Measures pulling force of machine tool spindle, a vital factor of machine tool performance.

The pulling force produced by the clamping device of machine tools could deteriorate due to degradation of disc springs or wear of the components of the booster. Pulling force is especially vital when it comes to dual face contact spindle interface, thus regular inspection is recommended.

- Periodical measurement avoids reduce rigidity leading to vibrations, loss machining quality, shortened tool life

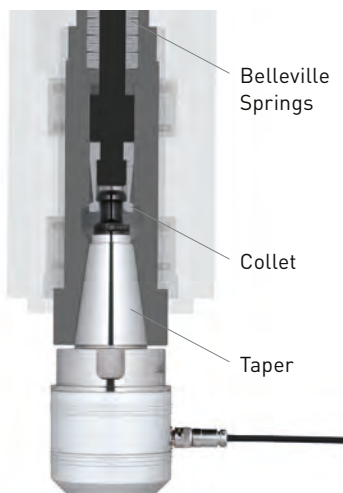

A calibration certificate and traceability diagram is offered upon request with charge for reliable use of these measuring instruments, or for the customers certified with ISO9000. Please contact us for details.

* Traceability is defined under JIS Z8103 as "the establishment of a pathway related to national and international standards in which standard instruments or measuring instruments are continually calibrated according to higher-level measurement standards."

Level Master

2-axis simultaneous detection leveler. LED displays level conditions for both axis simultaneously. LED and buzzer indication when leveling is complete.



- LED lamp + beep sound
- Simultaneous 2-axis detection saves the extra time & cost of using 2 levelers.
- 0.01 mm/m readable value

Standard Type

Wireless Type



Easy leveling with the remote display

Leveling by the single operator can be achievable by the use of the remote display while 2 operators have been necessary until now to allow them to conduct the level detecting inside the machine housing and the table leveling from outside of the machine separately.

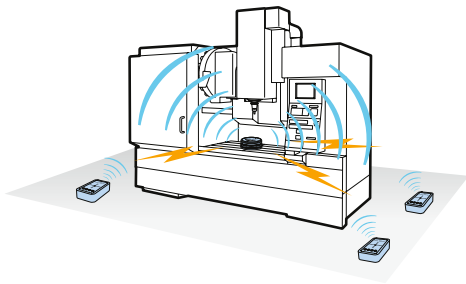

Simultaneous 2-axis detection

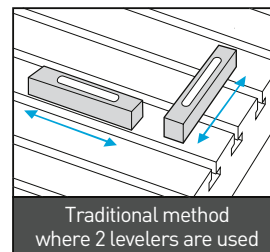

Traditional method where 2 levelers are used

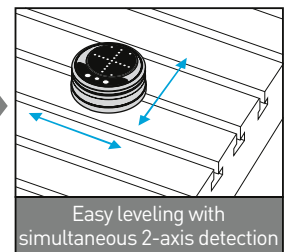

Easy leveling with simultaneous 2-axis detection

Torque Fit

Controlling tightening torque for BIG KAISER Tool assembly station with integrated torque measuring system.

- Digital display helps to reach the proper torque
- Tightening values for BIG KAISER collet chuck series data are preset
- Beeping on & after the proper tightening
- User mode for the customized torque value
- Error LED lightening at the overtightening
- Replaceable adaptors available for different interfaces



The starting point for the high precision cutting is proper tightening.

Insufficient tightening	Variant cutting edge position	Cutting Error Dimensional Error
	Collet deformation Deteriorated runout	Shorter Cutter Life Shorter Tool Holder Life
Over tightening		

Steep taper shanks JIS B6339 / BT / BBT

Model	ØD1	ØD2	L1	L2	L3	b	M
BT30	31.75	46	48.4	20	16.3	16.1	M12
BT40	44.45	63	65.4	25	22.6	16.1	M16
BT50	69.85	100	101.8	35	35.4	25.7	M24

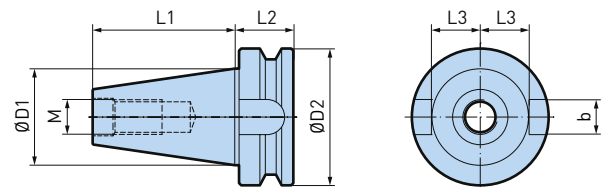

Steep taper shanks DIN 69871 / DV / BDV

Model	ØD1	ØD2 max.	ØD3	L1	L2	L3 min.	L4	L5	b	M
DV30	31.75	45	50	47.8	19.1	35	16.4	19	16.1	M12
DV40	44.45	50	63.55	68.4	19.1	35	22.8	25	16.1	M16
DV50	69.85	80	97.5	101.75	19.1	35	35.5	37.7	25.7	M24

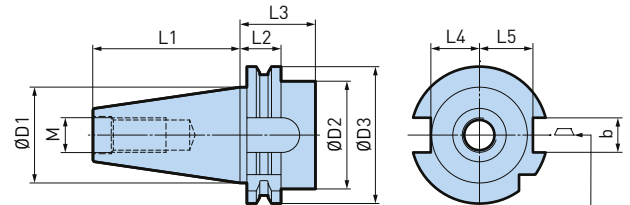

Position of the cutting edge on single cutter tools

Hollow taper shanks DIN 69893, form A

Model	ØD1	ØD2	ØD3 max.	L1	L2	L3 min.	b1	t1
HSK-A32	32	24.007	26	16	20	35	7.05	5.4
HSK-A40	40	30.007	34	20	20	35	8.05	5.2
HSK-A50	50	38.009	42	25	26	42	10.54	5.1
HSK-A63	63	48.010	53	32	26	42	12.54	5.0
HSK-A80	80	60.012	68	40	26	42	16.04	4.9
HSK-A100	100	75.013	88	50	29	45	20.02	4.9

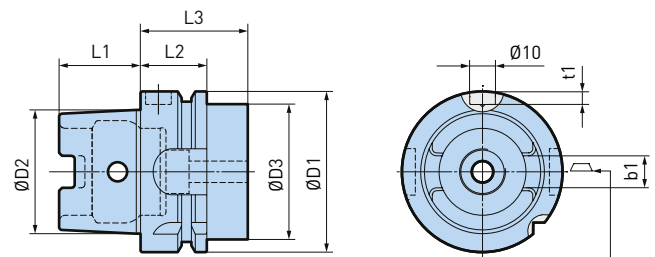

Position of the cutting edge on single cutter tools

Hollow taper shanks DIN 69893, form E

Model	ØD1	ØD2	ØD3 max.	L1	L2	L3 min.
HSK-E25	25	19.006	20	13	10	20
HSK-E32	32	24.007	26	16	20	35
HSK-E40	40	30.007	34	20	20	35
HSK-E50	50	38.009	42	25	26	42
HSK-E63	63	48.010	53	32	26	42

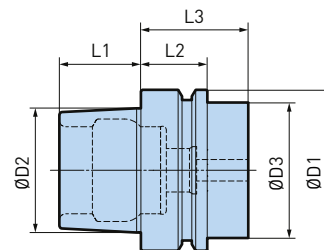

Hollow taper shanks ISO 12164-3, form T

Model	ØD1	ØD2	ØD3 max.	L1	L2	L3 min.	b1	b2	t1
HSK-T50	50	38.009	49	25	26	30	10.54	10.425	5.1
HSK-T63	63	48.010	62	32	26	30	12.54	12.425	5.0
HSK-T80	80	60.012	79	40	26	30	16.04	15.93	4.9
HSK-T100	100	75.013	99	50	29	34	20.02	19.91	4.9

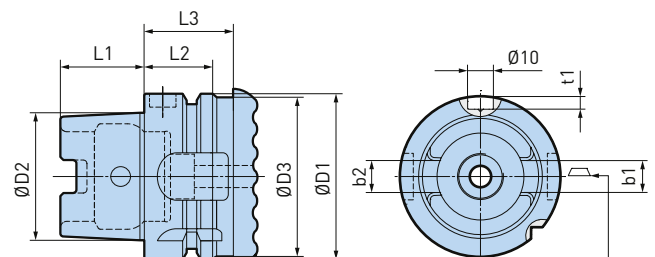

Position of the cutting edge on single cutter tools

BIG CAPTO (compatible with ISO 26623-1, polygonal hollow shank taper with face contact)

Model	ØD1	L1	L2
C3	32	19	15
C4	40	24	20
C5	50	30	20
C6	63	38	22
C8	80	48	30

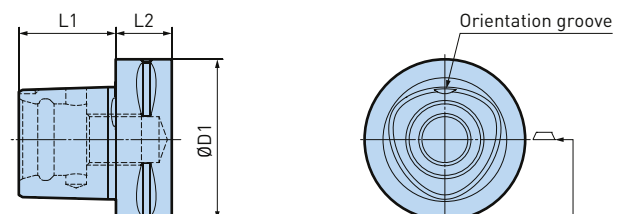

Position of the cutting edge on single cutting tools

BIG KAISER Balancing according to ISO 16084

What does balancing / unbalance / balance quality mean?

BIG KAISER toolholders are designed for high speed machines. If a rotating tool holder (Fig. 1) is not rotationally symmetrical, imbalance occurs (Fig. 2). As a result, when the rotational speed is increased, non-symmetrical centrifugal forces occur at the toolholder and the cutting tool, causing vibration and premature spindle bearing failure. To correct for the imbalance, the tool is balanced by various methods such as drilling (Fig. 3), milling, or grinding a flat, moving the center of mass as close as possible to the center of the axis of rotation.

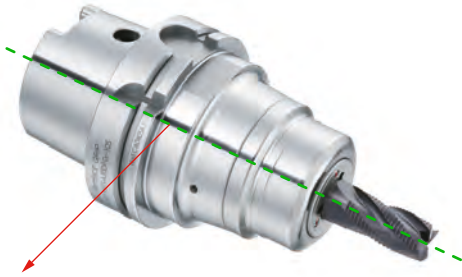

Fig. 1

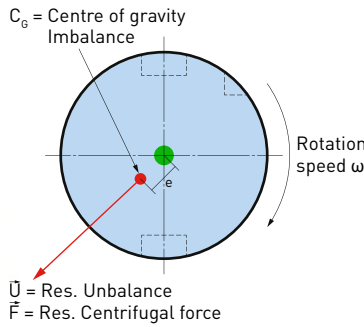

Fig. 2: unbalanced

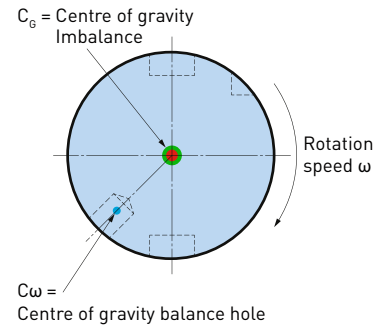

Fig. 3: balanced

Balancing requirements in practice using G2.5

The balancing quality G2.5 is widely used in the industry and is described in the ISO 1940-1 (issued in 2003) standard. However, this quality class is often overspecified and is in many cases not economically or technically feasible, especially when applied to smaller and lighter tools. The standard described above is designed for rigid rotors and is practical in a broader use for balancing. However, it cannot be applied to a complete system of spindles, tool holders and tools adequately and within technical constraints. For example, a tool to be compliant will have to be balanced to less than 1 gmm/kg at a speed of 25,000 rpm, which in turn corresponds to a mass eccentricity of less than 1 μm. This allowable tolerance is less than the interchange accuracy for even HSK, essentially negating all the costs and time for balancing the tool to such a strict tolerance.

BIG KAISER balancing policy

For this reason, all BIG KAISER tool holders are balanced according ISO 16084 (issued in 2017) specifically developed for rotating tool systems. ISO16084 focuses on the interaction between spindle and tool factoring in the allowable load on the spindle bearings generated by the tool's imbalance. This load must not exceed 1% of the dynamic load capacity of the spindle bearings. According to ISO 16084, the allowable unbalance tolerance is specified in [gmm], and is not expressed using a special quality grade [G].

In conclusion, BIG KAISER does not indicate any G-values for balancing quality, but rather the maximum rotational speeds of the individual tool holder. The values shown for each item number in the catalogue are in compliance with the requirements for standard balance quality according to ISO 16084.

Tool Holders BBT/BT, JIS B 6339

MEGA Micro Chuck	58
MEGA New Baby Chuck	60
MEGA E Chuck	64
MEGA Double Power Chuck	66
MEGA Perfect Grip	70
New Baby Chuck	71
New Hi-Power Milling Chuck	74
Hydraulic Chucks	78
Mold Chucks	87
Shrink Chucks	88
CK Shanks	91
Face Mill Arbors	96
Smart Damper Face Mill	98
Super Keyless Chucks	100
Side Lock Holders	101
 HOLDERS for Screw-On Cutters / Side Cutter Arbors	103
Morse Taper Holders	104
BIG CAPTO Basic Holder	105
MEGA Synchro Tapping Holder	106
Angle Heads	108
Air Turbine Spindle	123

A.1

MEGA Micro Chuck Type T

Tapered and slim design, minimal interference combined with maximized rigidity.

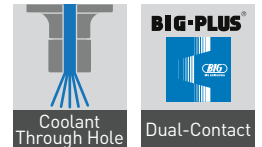

A.1

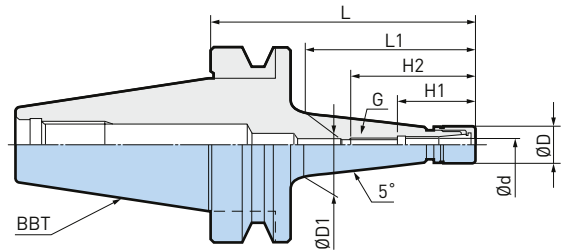

Ø0.45 - 8.05mm

Model	Order No.	Ød	ØD	ØD1	L	L1	H1	H2	G	max. min-1	Collet Model	Nut Model
BBT30-MEGA3S-45T	969.209	0.45 - 3.25	10	11.5	45	20	22	38	M4 P0.7	40000	NBC3S	MGN3S
BBT30-MEGA3S-75T	969.210	0.45 - 3.25	10	16	75	48	22	38	M4 P0.7	40000	NBC3S	MGN3S
BBT30-MEGA3S-90T	969.211	0.45 - 3.25	10	18.5	90	63	22	38	M4 P0.7	35000	NBC3S	MGN3S
BBT30-MEGA3S-105T	969.212	0.45 - 3.25	10	21	105	78	22	38	M4 P0.7	30000	NBC3S	MGN3S
BBT30-MEGA4S-60T	969.213	0.45 - 4.05	12	15	60	33	26.5	47	M5 P0.8	40000	NBC4S	MGN4S
BBT30-MEGA4S-75T	969.214	0.45 - 4.05	12	17.5	75	48	26.5	47	M5 P0.8	40000	NBC4S	MGN4S
BBT30-MEGA4S-90T	969.215	0.45 - 4.05	12	20	90	63	26.5	47	M5 P0.8	35000	NBC4S	MGN4S
BBT30-MEGA4S-105T	969.316	0.45 - 4.05	12	20	105	78	26.5	47	M5 P0.8	30000	NBC4S	MGN4S
BBT30-MEGA4S-120T	969.217	0.45 - 4.05	12	25.5	120	93	26.5	47	M5 P0.8	25000	NBC4S	MGN4S
BBT30-MEGA6S-60T	969.218	0.45 - 6.05	14	16.5	60	33	28.5	49	M7 P0.75	40000	NBC6S	MGN6S
BBT30-MEGA6S-75T	969.319	0.45 - 6.05	14	19	75	48	28.5	49	M7 P0.75	40000	NBC6S	MGN6S
BBT30-MEGA6S-90T	969.220	0.45 - 6.05	14	22	90	63	28.5	49	M7 P0.75	35000	NBC6S	MGN6S
BBT30-MEGA6S-105T	969.221	0.45 - 6.05	14	24.5	105	78	28.5	49	M7 P0.75	30000	NBC6S	MGN6S
BBT30-MEGA6S-120T	969.222	0.45 - 6.05	14	22	120	93	28.5	49	M7 P0.75	25000	NBC6S	MGN6S
BBT30-MEGA8S-75T	803.597	2.95 - 8.05	18	23	75	48	31	50.5	M9 P0.75	40000	NBC8S	MGN8S
BBT30-MEGA8S-105T	803.598	2.95 - 8.05	18	28	105	78	31	50.5	M9 P0.75	30000	NBC8S	MGN8S
BBT40-MEGA3S-60T	969.321	0.45 - 3.25	10	12.5	60	28	22	38	M4 P0.7	35000	NBC3S	MGN3S
BBT40-MEGA3S-90T	969.322	0.45 - 3.25	10	17.5	90	58	22	38	M4 P0.7	28000	NBC3S	MGN3S
BBT40-MEGA4S-120T	969.323	0.45 - 3.25	10	23	120	88	22	38	M4 P0.7	22000	NBC3S	MGN3S
BBT40-MEGA4S-60T	969.324	0.45 - 4.05	12	14	60	28	26.5	47	M5 P0.8	35000	NBC4S	MGN4S
BBT40-MEGA4S-75T	969.325	0.45 - 4.05	12	16.5	75	43	26.5	47	M5 P0.8	32000	NBC4S	MGN4S
BBT40-MEGA4S-90T	969.326	0.45 - 4.05	12	19.5	90	58	26.5	47	M5 P0.8	28000	NBC4S	MGN4S
BBT40-MEGA4S-105T	969.327	0.45 - 4.05	12	22	105	73	26.5	47	M5 P0.8	25000	NBC4S	MGN4S
BBT40-MEGA4S-120T	969.328	0.45 - 4.05	12	24.5	120	88	26.5	47	M5 P0.8	22000	NBC4S	MGN4S
BBT40-MEGA4S-135T	969.329	0.45 - 4.05	12	27	135	103	26.5	47	M5 P0.8	20000	NBC4S	MGN4S
BBT40-MEGA6S-60T	969.330	0.45 - 6.05	14	15.5	60	28	28.5	49	M7 P0.75	35000	NBC6S	MGN6S
BBT40-MEGA6S-75T	969.331	0.45 - 6.05	14	18	75	43	28.5	49	M7 P0.75	32000	NBC6S	MGN6S
BBT40-MEGA6S-90T	969.332	0.45 - 6.05	14	21	90	58	28.5	49	M7 P0.75	28000	NBC6S	MGN6S
BBT40-MEGA6S-105T	969.333	0.45 - 6.05	14	23.5	105	73	28.5	49	M7 P0.75	25000	NBC6S	MGN6S
BBT40-MEGA6S-120T	969.334	0.45 - 6.05	14	26	120	88	28.5	49	M7 P0.75	22000	NBC6S	MGN6S
BBT40-MEGA6S-135T	969.335	0.45 - 6.05	14	29	135	103	28.5	49	M7 P0.75	20000	NBC6S	MGN6S
BBT40-MEGA8S-90T	801.720	2.95 - 8.05	18	24.5	90	58	31	50.5	M9 P0.75	30000	NBC8S	MGN8S
BBT40-MEGA8S-120T	803.601	2.95 - 8.05	18	30	120	88	31	50.5	M9 P0.75	22000	NBC8S	MGN8S

1. BIG-PLUS® tools can be used in machining centers with non BIG-PLUS® spindles.
2. MEGA nut is included in delivery.

Accessories & Spare Parts

<p>MEGA Nuts</p> <p>▶ 326</p>	<p>Micro Seal Nuts</p> <p>▶ 326</p>	<p>Micro Collets</p> <p>▶ 324</p>	<p>MEGA Wrenches</p> <p>▶ 351</p>	<p>Taper Cleaners</p> <p>▶ 370</p>	<p>Collet Protective Cases</p> <p>▶ 326</p>
--------------------------------------	--	--	--	---	--

MEGA Micro Chuck Type S

Reduced diameter design is ideal for high speed applications and machining in tight spaces.

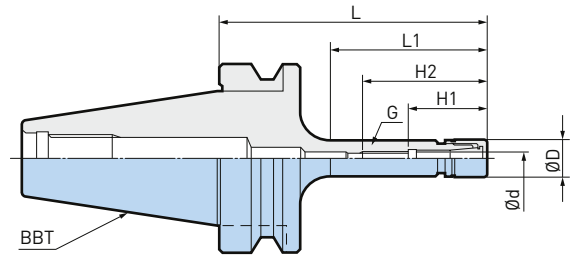
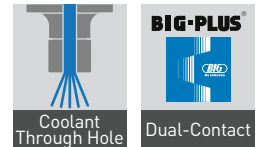

A.1

Ø0.45 - 8.05mm

Model	Order No.	Ød	ØD	L	L1	H1	H2	G	max. min-1	Collet Model	Nut Model
BBT30-MEGA4S-90	969.502	0,45 - 4,05	12	90	62	26,5	47	M5 P0.8	40000	NBC4S	MGN4S
BBT30-MEGA6S-60	969.503	0,45 - 6,05	14	60	32	28,5	49	M7 P0.75	40000	NBC6S	MGN6S
BBT30-MEGA6S-90	969.504	0,45 - 6,05	14	90	62	28,5	49	M7 P0.75	40000	NBC6S	MGN6S
BBT30-MEGA6S-105	800.058	0,45 - 6,05	14	105	73	28,5	49	M7 P0.75	40000	NBC6S	MGN6S
BBT30-MEGA8S-90	803.608	2,95 - 8,05	18	90	60	31	50,5	M9 P0.75	35000	NBC8S	MGN8S
BBT40-MEGA4S-90	969.506	0,45 - 4,05	12	90	53	26,5	47	M5 P0.8	35000	NBC4S	MGN4S
BBT40-MEGA6S-90	969.508	0,45 - 6,05	14	90	53	28,5	49	M7 P0.75	35000	NBC6S	MGN6S
BBT40-MEGA8S-90	803.599	2,95 - 8,05	18	90	55	31	50,5	M9 P0.75	30000	NBC8S	MGN8S

1. BIG-PLUS® tools can be used in machining centers with non BIG-PLUS® spindles.
2. MEGA nut is included in delivery.

Accessories & Spare Parts

<p>MEGA Nuts</p> <p>▶ 326</p>	<p>Micro Seal Nuts</p> <p>▶ 326</p>	<p>Micro Collets</p> <p>▶ 324</p>	<p>MEGA Wrenches</p> <p>▶ 351</p>	<p>Taper Cleaners</p> <p>▶ 370</p>	<p>Collet Protective Cases</p> <p>▶ 326</p>
--------------------------------------	--	--	--	---	--

MEGA New Baby Chuck

Ideal ultra precision collet holders for high speed machining. A wide range of lengths and a variety of collet series covers all machining applications.

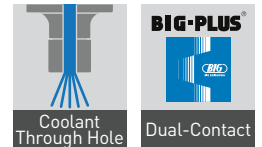

A.1

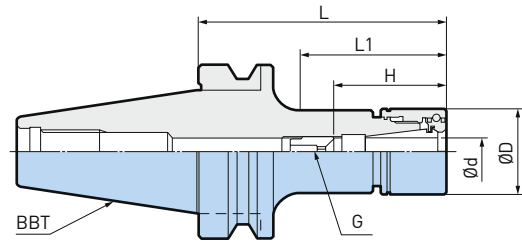

ø0.25 - 25.4mm

Model	Order No.	Ød	ØD	L	L1	H	max. min-1	Collet Model	Nut Model
BBT30-MEGA6N-60	969.509	• 0.25 - 6	20	60	32	23 - 43	40000	NBC6	MGN6
BBT30-MEGA6N-75	969.341	0.25 - 6	20	75	47	23 - 43	35000	NBC6	MGN6
BBT30-MEGA6N-90	969.510	0.25 - 6	20	90	62	23 - 43	30000	NBC6	MGN6
BBT30-MEGA6N-105	969.342	0.25 - 6	20	105	77	23 - 43	20000	NBC6	MGN6
BBT30-MEGA6N-120	969.343	0.25 - 6	20	120	90	23 - 43	18000	NBC6	MGN6
BBT30-MEGA8N-60	969.511	0.5 - 8	25	60	34	26 - 45	40000	NBC8	MGN8
BBT30-MEGA8N-75	969.344	0.5 - 8	25	75	49	26 - 45	35000	NBC8	MGN8
BBT30-MEGA8N-90	969.512	0.5 - 8	25	90	64	26 - 45	30000	NBC8	MGN8
BBT30-MEGA8N-105	969.345	0.5 - 8	25	105	79	26 - 45	20000	NBC8	MGN8
BBT30-MEGA8N-120	969.346	0.5 - 8	25	120	92	26 - 45	18000	NBC8	MGN8
BBT30-MEGA10N-60	969.513	• 1.5 - 10	30	60	34	38 - 48	40000	NBC10	MGN10
BBT30-MEGA10N-75	969.347	1.5 - 10	30	75	49	38 - 48	30000	NBC10	MGN10
BBT30-MEGA10N-90	969.534	1.5 - 10	30	90	64	38 - 48	25000	NBC10	MGN10
BBT30-MEGA10N-105	969.348	1.5 - 10	30	105	79	38 - 48	18000	NBC10	MGN10
BBT30-MEGA10N-120	978.207	1.5 - 10	30	120	94	38 - 48	15000	NBC10	MGN10
BBT30-MEGA13N-60	969.516	2.5 - 13	35	60	34	44 - 63	40000	NBC13	MGN13
BBT30-MEGA13N-75	969.349	• 2.5 - 13	35	75	49	44 - 63	30000	NBC13	MGN13
BBT30-MEGA13N-90	969.517	2.5 - 13	35	90	64	44 - 63	25000	NBC13	MGN13
BBT30-MEGA13N-105	969.350	2.5 - 13	35	105	79	44 - 63	18000	NBC13	MGN13
BBT30-MEGA13N-120	969.518	2.5 - 13	35	120	94	44 - 63	15000	NBC13	MGN13
BBT30-MEGA16N-60	969.519	2.5 - 16	42	60	37	48 - 63	35000	NBC16	MGN16
BBT30-MEGA16N-75	969.351	• 2.5 - 16	42	75	52	48 - 68	25000	NBC16	MGN16
BBT30-MEGA16N-90	969.520	2.5 - 16	42	90	67	48 - 68	20000	NBC16	MGN16
BBT30-MEGA16N-105	969.352	2.5 - 16	42	105	82	48 - 68	18000	NBC16	MGN16
BBT30-MEGA20N-60 *	969.521	2.5 - 20	46	60	-	70	30000	NBC20	MGN20
BBT30-MEGA20N-75	969.353	2.5 - 20	46	75	-	51 - 68	20000	NBC20	MGN20
BBT30-MEGA20N-90	969.522	2.5 - 20	46	90	-	51 - 68	15000	NBC20	MGN20
BBT30-MEGA20N-105	969.354	2.5 - 20	46	105	-	51 - 68	13000	NBC20	MGN20
BBT30-MEGA25N-85 *	806.379	15.5 - 25.4	60	85	-	80	12000	NBC25	MGN25

Model	Order No.	Ød	ØD	L	L1	H	max. min-1	Collet Model	Nut Model
BBT40-MEGA6N-60	969.523	0.25 - 6	20	60	27	23 - 43	35000	NBC6	MGN6
BBT40-MEGA6N-75	969.361	0.25 - 6	20	75	38	23 - 43	35000	NBC6	MGN6
BBT40-MEGA6N-90	969.524	0.25 - 6	20	90	53	23 - 43	35000	NBC6	MGN6
BBT40-MEGA6N-105	969.362	0.25 - 6	20	105	68	23 - 43	20000	NBC6	MGN6
BBT40-MEGA6N-120	969.363	0.25 - 6	20	120	83	23 - 43	20000	NBC6	MGN6
BBT40-MEGA6N-135	969.525	0.25 - 6	20	135	98	23 - 43	20000	NBC6	MGN6
BBT40-MEGA6N-165	969.526	0.25 - 6	20	165	128	23 - 43	14000	NBC6	MGN6
BBT40-MEGA6N-200	969.527	0.25 - 6	20	200	163	23 - 43	9000	NBC6	MGN6
BBT40-MEGA8N-60	969.528	0.5 - 8	25	60	27	26 - 45	35000	NBC8	MGN8
BBT40-MEGA8N-75	969.364	0.5 - 8	25	75	38	26 - 45	35000	NBC8	MGN8
BBT40-MEGA8N-90	969.529	0.5 - 8	25	90	53	26 - 45	35000	NBC8	MGN8
BBT40-MEGA8N-105	969.365	0.5 - 8	25	105	68	26 - 45	20000	NBC8	MGN8
BBT40-MEGA8N-120	969.366	0.5 - 8	25	120	83	26 - 45	20000	NBC8	MGN8
BBT40-MEGA8N-135	969.530	0.5 - 8	25	135	98	26 - 45	20000	NBC8	MGN8
BBT40-MEGA8N-165	969.531	0.5 - 8	25	165	128	26 - 45	14000	NBC8	MGN8
BBT40-MEGA8N-200	969.532	0.5 - 8	25	200	163	26 - 45	9000	NBC8	MGN8
BBT40-MEGA10N-60	969.533	1.5 - 10	30	60	27	38 - 48	35000	NBC10	MGN10
BBT40-MEGA10N-75	969.367	1.5 - 10	30	75	38	38 - 48	35000	NBC10	MGN10
BBT40-MEGA10N-90	969.514	1.5 - 10	30	90	53	38 - 48	35000	NBC10	MGN10
BBT40-MEGA10N-105	969.368	1.5 - 10	30	105	68	38 - 48	20000	NBC10	MGN10
BBT40-MEGA10N-120	969.369	1.5 - 10	30	120	83	38 - 48	20000	NBC10	MGN10
BBT40-MEGA10N-135	969.535	1.5 - 10	30	135	98	38 - 48	20000	NBC10	MGN10
BBT40-MEGA10N-165	969.536	1.5 - 10	30	165	128	38 - 48	15000	NBC10	MGN10
BBT40-MEGA10N-200	969.537	1.5 - 10	30	200	163	38 - 48	10000	NBC10	MGN10
BBT40-MEGA13N-60	969.538	2.5 - 13	35	60	31	44 - 63	35000	NBC13	MGN13
BBT40-MEGA13N-75	969.370	2.5 - 13	35	75	40	44 - 63	35000	NBC13	MGN13
BBT40-MEGA13N-90	969.539	2.5 - 13	35	90	55	44 - 63	35000	NBC13	MGN13
BBT40-MEGA13N-105	969.371	2.5 - 13	35	105	70	44 - 63	20000	NBC13	MGN13
BBT40-MEGA13N-120	969.372	2.5 - 13	35	120	85	44 - 63	20000	NBC13	MGN13
BBT40-MEGA13N-135	969.540	2.5 - 13	35	135	100	44 - 63	20000	NBC13	MGN13
BBT40-MEGA13N-165	969.541	2.5 - 13	35	165	130	44 - 63	15000	NBC13	MGN13
BBT40-MEGA13N-200	969.542	2.5 - 13	35	200	165	44 - 63	10000	NBC13	MGN13

continues on the next page



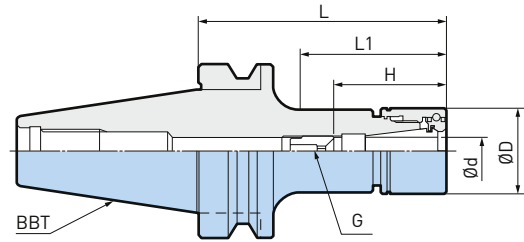







A.1

Model	Order No.	Ød	ØD	L	L1	H	max. min-1	Collet Model	Nut Model
BBT40-MEGA16N-60	969.543	2.5 - 16	42	60	31	48 - 68	30000	NBC16	MGN16
BBT40-MEGA16N-75	969.373	2.5 - 16	42	75	40	48 - 68	30000	NBC16	MGN16
BBT40-MEGA16N-90	969.544	2.5 - 16	42	90	55	48 - 68	30000	NBC16	MGN16
BBT40-MEGA16N-105	969.374	2.5 - 16	42	105	70	48 - 68	20000	NBC16	MGN16
BBT40-MEGA16N-120	969.375	2.5 - 16	42	120	85	48 - 68	20000	NBC16	MGN16
BBT40-MEGA16N-135	969.545	2.5 - 16	42	135	100	48 - 68	20000	NBC16	MGN16
BBT40-MEGA16N-165	969.546	2.5 - 16	42	165	130	48 - 68	15000	NBC16	MGN16
BBT40-MEGA16N-200	969.547	2.5 - 16	42	200	165	48 - 68	10000	NBC16	MGN16
BBT40-MEGA20N-60	969.548	• 2.5 - 20	46	60	31	51 - 68	30000	NBC20	MGN20
BBT40-MEGA20N-75	969.376	2.5 - 20	46	75	42	51 - 68	30000	NBC20	MGN20
BBT40-MEGA20N-90	969.549	• 2.5 - 20	46	90	57	51 - 68	30000	NBC20	MGN20
BBT40-MEGA20N-105	969.377	2.5 - 20	46	105	72	51 - 68	20000	NBC20	MGN20
BBT40-MEGA20N-120	969.378	2.5 - 20	46	120	87	51 - 68	20000	NBC20	MGN20
BBT40-MEGA20N-135	969.550	2.5 - 20	46	135	102	51 - 68	20000	NBC20	MGN20
BBT40-MEGA20N-165	969.551	2.5 - 20	46	165	132	51 - 68	15000	NBC20	MGN20
BBT40-MEGA20N-200	969.552	2.5 - 20	46	200	167	51 - 68	10000	NBC20	MGN20
BBT40-MEGA25N-75	806.380	15.5 - 25.4	60	75	47	64 - 74	25000	NBC25	MGN25
BBT40-MEGA25N-90	806.381	15.5 - 25.4	60	90	62	64 - 74	20000	NBC25	MGN25
BBT40-MEGA25N-105	806.382	15.5 - 25.4	60	105	77	64 - 74	19000	NBC25	MGN25
BBT40-MEGA25N-120	806.383	15.5 - 25.4	60	120	92	64 - 74	17000	NBC25	MGN25

Model	Order No.	Ød	ØD	L	L1	H	max. min-1	Collet Model	Nut Model
BBT50-MEGA6N-90	969.553	0.25 - 6	20	90	37	23 - 43	20000	NBC6	MGN6
BBT50-MEGA6N-120	969.554	0.25 - 6	20	120	67	23 - 43	20000	NBC6	MGN6
BBT50-MEGA6N-165	969.555	0.25 - 6	20	165	112	23 - 43	14000	NBC6	MGN6
BBT50-MEGA6N-200	969.556	0.25 - 6	20	200	147	23 - 43	9000	NBC6	MGN6
BBT50-MEGA8N-90	969.557	0.5 - 8	25	90	42	26 - 45	20000	NBC8	MGN8
BBT50-MEGA8N-120	969.558	0.5 - 8	25	120	67	26 - 45	20000	NBC8	MGN8
BBT50-MEGA8N-165	969.559	0.5 - 8	25	165	112	26 - 45	16000	NBC8	MGN8
BBT50-MEGA8N-200	969.560	0.5 - 8	25	200	147	26 - 45	11000	NBC8	MGN8
BBT50-MEGA10N-90	969.561	1.5 - 10	30	90	42	38 - 48	20000	NBC10	MGN10
BBT50-MEGA10N-120	969.562	1.5 - 10	30	120	67	38 - 48	20000	NBC10	MGN10
BBT50-MEGA10N-165	969.563	1.5 - 10	30	165	112	38 - 48	16000	NBC10	MGN10
BBT50-MEGA10N-200	969.564	1.5 - 10	30	200	147	38 - 48	13000	NBC10	MGN10
BBT50-MEGA10N-250	969.565	1.5 - 10	30	250	197	38 - 48	8000	NBC10	MGN10
BBT50-MEGA10N-300	969.566	1.5 - 10	30	300	247	38 - 48	5500	NBC10	MGN10
BBT50-MEGA13N-90	969.567	2.5 - 13	35	90	42	44 - 63	18000	NBC13	MGN13
BBT50-MEGA13N-120	969.568	2.5 - 13	35	120	67	44 - 63	18000	NBC13	MGN13
BBT50-MEGA13N-165	969.569	2.5 - 13	35	165	112	44 - 63	16000	NBC13	MGN13
BBT50-MEGA13N-200	969.570	2.5 - 13	35	200	147	44 - 63	12000	NBC13	MGN13
BBT50-MEGA13N-250	969.571	2.5 - 13	35	250	197	44 - 63	8000	NBC13	MGN13
BBT50-MEGA13N-300	969.572	2.5 - 13	35	300	247	44 - 63	5500	NBC13	MGN13
BBT50-MEGA16N-75	969.573	2.5 - 16	42	75	31	48 - 68	17000	NBC16	MGN16
BBT50-MEGA16N-90	969.574	2.5 - 16	42	90	42	48 - 68	17000	NBC16	MGN16
BBT50-MEGA16N-120	969.575	2.5 - 16	42	120	72	48 - 68	17000	NBC16	MGN16
BBT50-MEGA16N-165	969.576	2.5 - 16	42	165	117	48 - 68	16000	NBC16	MGN16
BBT50-MEGA16N-200	969.577	2.5 - 16	42	200	152	48 - 68	13000	NBC16	MGN16
BBT50-MEGA16N-250	969.578	2.5 - 16	42	250	202	48 - 68	10000	NBC16	MGN16
BBT50-MEGA20N-75	969.579	2.5 - 20	46	75	31	51 - 68	16000	NBC20	MGN20
BBT50-MEGA20N-90	969.580	2.5 - 20	46	90	42	51 - 68	17000	NBC20	MGN20
BBT50-MEGA20N-120	969.581	2.5 - 20	46	120	72	51 - 68	16000	NBC20	MGN20
BBT50-MEGA20N-165	969.582	2.5 - 20	46	165	117	51 - 68	15000	NBC20	MGN20
BBT50-MEGA20N-200	969.583	2.5 - 20	46	200	152	51 - 68	13000	NBC20	MGN20
BBT50-MEGA20N-250	969.584	2.5 - 20	46	250	202	51 - 68	10000	NBC20	MGN20
BBT50-MEGA25N-90	806.384	15.5 - 25.4	60	90	46	64 - 74	19000	NBC25	MGN25
BBT50-MEGA25N-120	806.385	15.5 - 25.4	60	120	72	64 - 74	17000	NBC25	MGN25
BBT50-MEGA25N-165	806.386	15.5 - 25.4	60	165	117	64 - 74	15000	NBC25	MGN25
BBT50-MEGA25N-200	806.387	15.5 - 25.4	60	200	152	64 - 74	13000	NBC25	MGN25

1. BIG-PLUS® tools can be used in machining centers with non BIG-PLUS® spindles.
2. MEGA nut is included in delivery.
3. * Adjusting screw cannot be used.
4. "H" is the max. tool shank length that can be inserted for these models.
5. "G" is the adjusting screw (optional).

Accessories & Spare Parts

<p>MEGA Nuts</p>  <p>▶ 334</p>	<p>MEGA Perfect Seals</p>  <p>▶ 336</p>	<p>New Baby Collets</p>  <p>▶ 327</p>	<p>MEGA Wrenches</p>  <p>▶ 351</p>	<p>Adjusting Screws NBA</p>  <p>▶ 335</p>	<p>Taper Cleaners</p>  <p>▶ 370</p>
---	--	--	---	--	--

MEGA E Chuck

Collet chuck designed for milling with high concentricity and rigidity in hard materials.

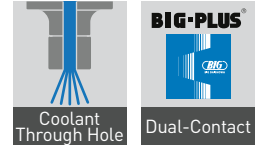

A.1

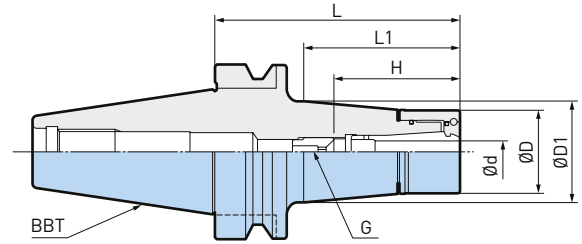







ø3 - 12mm

Model	Order No.	Ød	ØD	ØD1	L	L1	H	max. min-1	Collet Model	Nut Model
BBT30-MEGA6E-50	968.166	3 - 6	25	26	50	25	37 - 45	40000	MEC6	MEN 6
BBT30-MEGA6E-75	968.167	3 - 6	25	30	75	50	37 - 45	35000	MEC6	MEN 6
BBT30-MEGA6E-90	968.168	3 - 6	25	32.5	90	65	37 - 45	25000	MEC6	MEN 6
BBT30-MEGA6E-105	968.169	3 - 6	25	35.5	105	80	37 - 45	25000	MEC6	MEN 6
BBT30-MEGA8E-50	968.170	3 - 8	30	30.5	50	25	42 - 51	40000	MEC8	MEN 8
BBT30-MEGA8E-75	968.171	3 - 8	30	35	75	50	42 - 51	35000	MEC8	MEN 8
BBT30-MEGA8E-90	968.172	3 - 8	30	37.5	90	66	42 - 51	30000	MEC8	MEN 8
BBT30-MEGA8E-105	968.173	3 - 8	30	40.5	105	81	42 - 51	25000	MEC8	MEN 8
BBT30-MEGA10E-50	968.174	• 3 - 10	35	35.5	50	25	48 - 58	39000	MEC10	MEN10
BBT30-MEGA10E-75	968.175	3 - 10	35	40	75	51	48 - 58	35000	MEC10	MEN10
BBT30-MEGA10E-90	968.176	3 - 10	35	41	90	66	48 - 58	25000	MEC10	MEN10
BBT30-MEGA10E-105	968.177	3 - 10	35	44	105	82	48 - 58	25000	MEC10	MEN10
BBT30-MEGA13E-50	968.178	3 - 12	42	42.5	50	27	50 - 58	38000	MEC13	MEN13
BBT30-MEGA13E-75	968.179	• 3 - 12	42	42	75	52	50 - 60	34000	MEC13	MEN13
BBT30-MEGA13E-90	968.180	3 - 12	42	42	90	67	50 - 60	25000	MEC13	MEN13
BBT30-MEGA13E-105	968.181	3 - 12	42	42	105	82	50 - 60	25000	MEC13	MEN13
BBT40-MEGA6E-60	968.183	3 - 6	25	26.5	60	28	37 - 45	30000	MEC6	MEN 6
BBT40-MEGA6E-75	968.184	3 - 6	25	29	75	43	42 - 51	30000	MEC6	MEN 6
BBT40-MEGA6E-90	968.185	3 - 6	25	31.5	90	58	37 - 45	30000	MEC6	MEN 6
BBT40-MEGA6E-105	968.186	3 - 6	25	34	105	73	37 - 45	29000	MEC6	MEN 6
BBT40-MEGA6E-120	968.187	3 - 6	25	36.5	120	88	37 - 45	29000	MEC6	MEN 6
BBT40-MEGA6E-135	968.188	3 - 6	25	39	135	103	37 - 45	27000	MEC6	MEN 6
BBT40-MEGA6E-165	968.189	3 - 6	25	44.5	165	133	37 - 45	20000	MEC6	MEN 6
BBT40-MEGA6E-200	968.190	3 - 6	25	51	200	169	37 - 45	15000	MEC6	MEN 6
BBT40-MEGA8E-60	968.191	3 - 8	30	31	60	28	42 - 48	30000	MEC8	MEN 8
BBT40-MEGA8E-75	968.192	3 - 8	30	33.5	75	43	42 - 51	30000	MEC8	MEN 8
BBT40-MEGA8E-90	968.193	3 - 8	30	36	90	58	42 - 51	30000	MEC8	MEN 8
BBT40-MEGA8E-105	968.194	3 - 8	30	39	105	73	42 - 51	29000	MEC8	MEN 8
BBT40-MEGA8E-120	968.195	3 - 8	30	41.5	120	88	42 - 51	29000	MEC8	MEN 8
BBT40-MEGA8E-135	968.196	3 - 8	30	44	135	103	42 - 51	27000	MEC8	MEN 8
BBT40-MEGA8E-165	968.197	3 - 8	30	49.5	165	133	42 - 51	20000	MEC8	MEN 8
BBT40-MEGA8E-200	968.198	3 - 8	30	56	200	171	42 - 51	15000	MEC8	MEN 8
BBT40-MEGA10E-60	968.199	• 3 - 10	35	36	60	29	48 - 58	30000	MEC10	MEN10
BBT40-MEGA10E-75	968.200	3 - 10	35	38.5	75	43	48 - 58	30000	MEC10	MEN10
BBT40-MEGA10E-90	968.201	3 - 10	35	41	90	58	48 - 58	30000	MEC10	MEN10
BBT40-MEGA10E-105	968.202	3 - 10	35	44	105	73	48 - 58	29000	MEC10	MEN10
BBT40-MEGA10E-120	968.203	3 - 10	35	46.5	120	88	48 - 58	29000	MEC10	MEN10
BBT40-MEGA10E-135	968.204	3 - 10	35	49	135	103	48 - 58	27000	MEC10	MEN10
BBT40-MEGA10E-165	968.205	3 - 10	35	54.5	165	135	48 - 58	22000	MEC10	MEN10
BBT40-MEGA10E-200	968.206	3 - 10	35	55.5	200	171	48 - 58	16000	MEC10	MEN10

Model	Order No.	Ød	ØD	ØD1	L	L1	H	max. min-1	Collet Model	Nut Model
BBT40-MEGA13E-60	968.207	• 3 - 12	42	43	60	29	50 - 60	30000	MEC13	MEN13
BBT40-MEGA13E-75	968.208	3 - 12	42	45	75	43	50 - 60	30000	MEC13	MEN13
BBT40-MEGA13E-90	968.209	• 3 - 12	42	48	90	59	50 - 60	30000	MEC13	MEN13
BBT40-MEGA13E-105	968.210	3 - 12	42	51	105	75	50 - 60	29000	MEC13	MEN13
BBT40-MEGA13E-120	968.211	3 - 12	42	53.5	120	91	50 - 60	29000	MEC13	MEN13
BBT40-MEGA13E-135	968.212	3 - 12	42	56	135	106	50 - 60	26000	MEC13	MEN13
BBT40-MEGA13E-165	968.213	3 - 12	42	57.5	165	137	50 - 60	22000	MEC13	MEN13
BBT40-MEGA13E-200	968.214	3 - 12	42	62.5	200	173	50 - 60	16000	MEC13	MEN13
BBT50-MEGA6E-90	968.216	3 - 6	25	30.5	90	47	37 - 45	20000	MEC6	MEN 6
BBT50-MEGA6E-120	968.217	3 - 6	25	36	120	77	37 - 45	20000	MEC6	MEN 6
BBT50-MEGA6E-165	968.218	3 - 6	25	43.5	165	122	37 - 45	14000	MEC6	MEN 6
BBT50-MEGA6E-200	968.219	3 - 6	25	50	200	157	37 - 45	9000	MEC6	MEN 6
BBT50-MEGA8E-90	968.220	3 - 8	30	35.5	90	47	42 - 51	20000	MEC8	MEN 8
BBT50-MEGA8E-120	968.221	3 - 8	30	40.5	120	77	42 - 51	20000	MEC8	MEN 8
BBT50-MEGA8E-165	968.222	3 - 8	30	48.5	165	122	42 - 51	16000	MEC8	MEN 8
BBT50-MEGA8E-200	968.223	3 - 8	30	54.5	200	157	42 - 51	11000	MEC8	MEN 8
BBT50-MEGA10E-90	968.224	3 - 10	35	40	90	47	48 - 58	25000	MEC10	MEN10
BBT50-MEGA10E-120	968.225	3 - 10	35	45.5	120	77	48 - 58	20000	MEC10	MEN10
BBT50-MEGA10E-165	968.226	3 - 10	35	53	165	121	48 - 58	16000	MEC10	MEN10
BBT50-MEGA10E-200	968.227	3 - 10	35	59.5	200	156	48 - 58	13000	MEC10	MEN10
BBT50-MEGA13E-90	968.228	3 - 12	42	46.5	90	47	50 - 60	18000	MEC13	MEN13
BBT50-MEGA13E-120	968.229	• 3 - 12	42	52	120	77	50 - 60	18000	MEC13	MEN13
BBT50-MEGA13E-165	968.230	3 - 12	42	59	165	121	50 - 60	16000	MEC13	MEN13
BBT50-MEGA13E-200	968.231	3 - 12	42	59	200	156	50 - 60	12000	MEC13	MEN13

1. BIG-PLUS® tools can be used in machining centers with non BIG-PLUS® spindles.
2. MEGA E nut is included.
3. "H" is the max. tool shank length that can be inserted for these models.
4. "G" is the adjusting screw (optional).

Accessories & Spare Parts

<p>MEGA E Nuts</p>  <p>▶ 340</p>	<p>MEGA E Perfect Seals</p>  <p>▶ 341</p>	<p>MEGA E Collets</p>  <p>▶ 340</p>	<p>MEGA Wrenches</p>  <p>▶ 351</p>	<p>Adjusting Screws NBA</p>  <p>▶ 335</p>	<p>Taper Cleaners</p>  <p>▶ 370</p>
---	--	--	---	--	--

MEGA Double Power Chuck Type D

Flange contacting nut assures highest rigidity. Type D for use with/without coolant through.

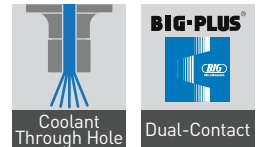

A.1



ø3 - 42mm

Model	Order No.	Fig.	Ød	ØD	ØD1	L	L1	L2	H	E	E1	max. min-1
BBT30-MEGA16D-60	978.188	1	16	45	47	60	25	-	62	48	50	30000
BBT30-MEGA20D-65 *	978.187	1	20	50	51	65	30	-	60	50	50	25000
BBT40-MEGA16D-75A	801.711	2	16	42	53	75	25	38	71	48	55	30000
BBT40-MEGA16D-105A	801.730	2	16	42	53	105	25	38	71	48	55	30000
BBT40-MEGA16D-135A	803.115	2	16	42	53	135	25	38	71	48	55	25000
BBT40-MEGA16D-165A	803.196	2	16	42	53	165	25	38	71	48	55	22000
BBT40-MEGA16D-200A	803.157	2	16	42	53	200	25	38	71	48	55	18000
BBT40-MEGA20D-75A	803.148	2	20	50	55	75	34	44	69 - 79	50	56	30000
BBT40-MEGA20D-105A	803.116	2	20	50	55	105	34	44	69 - 79	50	56	30000
BBT40-MEGA20D-120A	803.197	2	20	50	55	120	34	44	69 - 79	50	56	27000
BBT40-MEGA20D-135A	803.130	2	20	50	55	135	34	44	69 - 79	50	56	25000
BBT40-MEGA20D-165A	803.158	2	20	50	55	165	34	44	69 - 79	50	56	22000
BBT40-MEGA20D-200A	803.188	2	20	50	55	200	34	44	69 - 79	50	56	15000
BBT40-MEGA25D-75A	801.731	• 1	25	62	63	75	39	-	73 - 83	56	57	27000
BBT40-MEGA25D-105A	803.198	1	25	62	63	105	39	-	71 - 81	56	57	26000
BBT40-MEGA25D-135A	801.732	1	25	62	63	135	39	-	71 - 81	56	57	24000
BBT40-MEGA25D-165A	803.134	1	25	62	63	165	39	-	71 - 81	56	57	21000
BBT40-MEGA25D-200A	803.138	1	25	62	63	200	39	-	71 - 81	56	57	12000
BBT40-MEGA32D-90A	803.199	• 1	32	70	71	90	33	-	71 - 81	60	64	26000
BBT40-MEGA32D-105A	803.131	1	32	70	71	105	33	-	79 - 89	60	64	26000
BBT40-MEGA32D-135A	803.135	1	32	70	71	135	33	-	79 - 89	60	64	22000
BBT40-MEGA32D-165A	803.159	1	32	70	71	165	33	-	79 - 89	60	64	20000
BBT40-MEGA32D-200A	803.186	1	32	70	71	200	33	-	79 - 89	60	64	10000

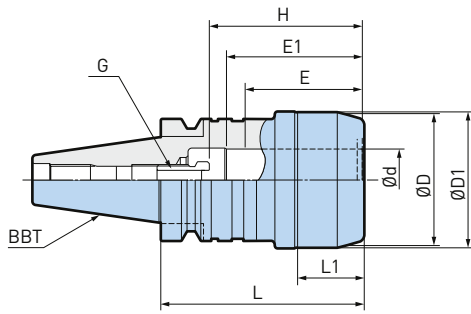

Fig. 1

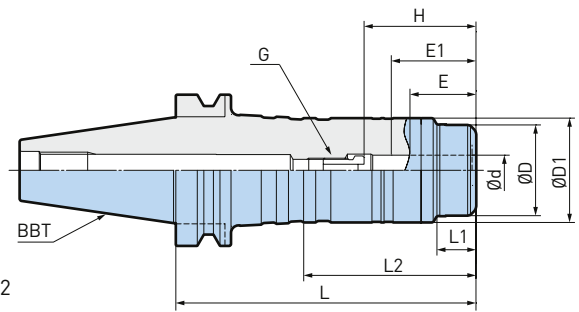







Fig. 2

Model	Order No.	Fig.	Ød	ØD	ØD1	L	L1	L2	H	E	E1	max. min-1
BBT50-MEGA16D-105	969.592	2	16	46	55	105	23	33	71	48	50	21000
BBT50-MEGA16D-135	968.026	2	16	46	55	135	23	33	71	48	50	21000
BBT50-MEGA16D-165	968.027	2	16	46	55	165	23	33	71	48	50	19000
BBT50-MEGA16D-200	968.028	2	16	46	55	200	23	33	71	48	50	15000
BBT50-MEGA20D-105	969.593	2	20	60	69	105	25	36	69 - 79	50	56	20000
BBT50-MEGA20D-135	969.594	2	20	60	69	135	25	36	69 - 79	50	56	19000
BBT50-MEGA20D-165	968.030	2	20	60	69	165	25	36	69 - 79	50	56	17000
BBT50-MEGA20D-200	968.031	2	20	60	69	200	25	114	69 - 79	50	56	14000
BBT50-MEGA25D-105	969.595	2	25	70	77	105	32	45	76 - 86	56	65	20000
BBT50-MEGA25D-135	969.596	2	25	70	77	135	32	45	76 - 86	56	65	19000
BBT50-MEGA25D-165	968.033	2	25	70	77	165	32	45	76 - 86	56	65	17000
BBT50-MEGA25D-200	968.034	2	25	70	77	200	32	119	76 - 86	56	65	12000
BBT50-MEGA32D-90	968.036	2	32	80	86	90	39	54	78 - 95	60	71	25000
BBT50-MEGA32D-105	969.597	2	32	80	86	105	39	54	78 - 95	60	71	20000
BBT50-MEGA32D-135	969.598	2	32	80	86	135	39	54	78 - 95	60	71	18000
BBT50-MEGA32D-165	968.037	2	32	80	86	165	39	54	78 - 95	60	71	15000
BBT50-MEGA32D-200	968.038	2	32	80	86	200	39	129	78 - 95	60	71	12000
BBT50-MEGA32D-250	968.039	2	32	80	86	250	39	169	78 - 95	60	71	10000
BBT50-MEGA42D-105	968.041	1	42	99	100	105	40	-	88 - 105	70	71	15000
BBT50-MEGA42D-135	968.042	1	42	99	100	135	40	-	88 - 105	70	71	15000
BBT50-MEGA42D-165	968.043	1	42	99	100	165	40	-	88 - 105	70	71	14000

1. BIG-PLUS® tools can be used in machining centers with non BIG-PLUS® spindles.
2. Wrench and axial adjusting screw are to be ordered separately.
3. As a back stop for cutting tools for the MEGA16D models, a commercially available hex socket head screw can be used.
4. "H" is the max. tool shank length that can be inserted for these models.
5. "G" is the adjusting screw (optional).
6. "E" is the min. clamping length.
7. "E1" is the min. clamping length for optimum use with center through coolant.
8. * Only OCA collet and C collet can be used.

Accessories & Spare Parts

<p>PJC Collets</p>  <p>▶ 347</p>	<p>OCA Collets</p>  <p>▶ 348</p>	<p>PSC Collets</p>  <p>▶ 348</p>	<p>C Collets</p>  <p>▶ 349</p>	<p>MEGA Wrenches</p>  <p>▶ 351</p>	<p>Adjusting Screws HMA</p>  <p>▶ 350</p>
---	---	---	---	---	--

MEGA Double Power Chuck Type DS

Flange contacting nut assures highest rigidity. Unique coolant supply design ensures efficient coolant supply to the cutting tool peripherally.

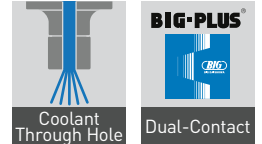

A.1



ø3 - 42mm

Model	Order No.	Fig.	Ød	ØD	ØD1	L	L1	L2	H	E	max. min-1
BBT30-MEGA16DS-60	978.030	1	16	46	47	62.5	28	-	64	50	30000
BBT30-MEGA20DS-65 *	978.184	1	20	50	51	67.5	33	-	62	52	25000
BBT40-MEGA16DS-75A	801.712	2	16	42	53	77	27	40	73	50	30000
BBT40-MEGA16DS-105A	803.149	2	16	42	53	107	27	40	73	50	30000
BBT40-MEGA16DS-135A	803.117	2	16	42	53	137	27	40	73	50	25000
BBT40-MEGA16DS-165A	803.200	2	16	42	53	167	27	40	73	50	22000
BBT40-MEGA16DS-200A	803.160	2	16	42	53	202	27	40	73	50	18000
BBT40-MEGA20DS-75A	803.150	• 2	20	50	55	77	36	46	71 - 81	52	30000
BBT40-MEGA20DS-105A	803.118	2	20	50	55	107	36	46	71 - 81	52	30000
BBT40-MEGA20DS-120A	803.201	2	20	50	55	122	36	46	71 - 81	52	27000
BBT40-MEGA20DS-135A	803.132	2	20	50	55	137	36	46	71 - 81	52	25000
BBT40-MEGA20DS-165A	803.161	2	20	50	55	167	36	46	71 - 81	58	22000
BBT40-MEGA20DS-200A	803.189	2	20	50	55	202	36	46	71 - 81	52	15000
BBT40-MEGA25DS-75A	803.119	1	25	62	63	77	41	-	75 - 85	58	27000
BBT40-MEGA25DS-105A	801.713	1	25	62	63	107	41	-	73 - 83	58	26000
BBT40-MEGA25DS-135A	803.162	1	25	62	63	137	41	-	73 - 83	58	24000
BBT40-MEGA25DS-165A	803.136	1	25	62	63	167	41	-	73 - 83	58	21000
BBT40-MEGA25DS-200A	803.139	1	25	62	63	202	41	-	71 - 81	58	12000
BBT40-MEGA32DS-90A	803.202	• 1	32	70	71	92	35	-	73 - 83	62	26000
BBT40-MEGA32DS-105A	803.133	• 1	32	70	71	107	35	-	81 - 91	62	26000
BBT40-MEGA32DS-135A	803.137	1	32	70	71	137	35	-	81 - 91	62	22000
BBT40-MEGA32DS-165A	803.163	1	32	70	71	167	35	-	81 - 91	62	20000
BBT40-MEGA32DS-200A	803.187	1	32	70	71	202	35	-	81 - 91	62	10000

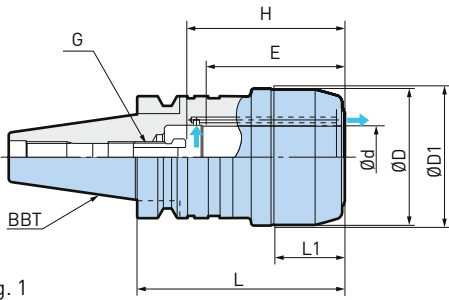

Fig. 1

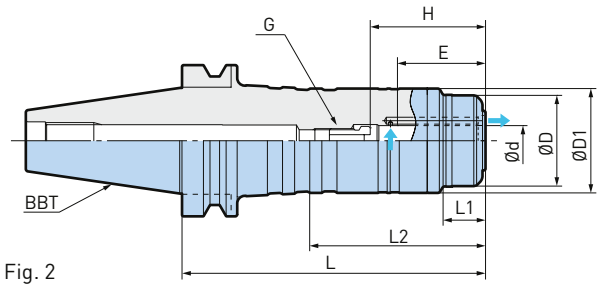

Fig. 2

Model	Order No.	Fig.	Ød	ØD	ØD1	L	L1	L2	H	E	max. min-1
BBT50-MEGA16DS-105	968.708	2	16	46	55	107.5	26	36	73	50	21000
BBT50-MEGA16DS-135	968.076	2	16	46	55	137.5	26	36	73	50	21000
BBT50-MEGA16DS-165	968.077	2	16	46	55	167.5	26	36	73	50	19000
BBT50-MEGA16DS-200	968.078	2	16	46	55	202,5	26	36	73	50	15000
BBT50-MEGA16DS-250	968.079	2	20	46	55	252,5	26	36	73	50	13000
BBT50-MEGA20DS-105	968.709	2	20	60	69	107.5	28	38	71 - 81	52	20000
BBT50-MEGA20DS-135	968.710	2	20	60	69	137.5	28	38	71 - 81	52	19000
BBT50-MEGA20DS-165	968.080	2	20	60	69	167.5	28	38	71 - 81	52	17000
BBT50-MEGA20DS-200	968.081	2	20	60	69	202,5	28	116	71 - 81	52	14000
BBT50-MEGA20DS-250	968.082	2	20	60	69	252,5	28	138	71 - 81	52	12000
BBT50-MEGA25DS-105	968.711	2	25	70	77	107.5	34	47	78 - 88	58	20000
BBT50-MEGA25DS-135	968.712	2	25	70	77	137.5	34	47	78 - 88	58	19000
BBT50-MEGA25DS-165	968.083	2	25	70	77	167.5	34	47	78 - 88	58	17000
BBT50-MEGA25DS-200	968.084	2	25	70	77	205,5	34	121	78 - 88	58	12000
BBT50-MEGA25DS-250	968.085	2	25	70	77	252,5	34	138	78 - 88	58	10000
BBT50-MEGA32DS-90	968.086	2	32	80	86	94.5	42	57	80 - 97	62	20000
BBT50-MEGA32DS-105	968.713	2	32	80	86	107.5	42	57	80 - 97	62	20000
BBT50-MEGA32DS-135	968.714	2	32	80	86	137.5	42	57	80 - 97	62	18000
BBT50-MEGA32DS-165	968.087	2	32	80	86	167.5	42	57	80 - 97	62	15000
BBT50-MEGA32DS-200	968.088	2	32	80	86	202.5	42	131	80 - 97	62	12000
BBT50-MEGA32DS-250	968.089	2	32	80	86	252,5	42	171	80 - 97	62	10000
BBT50-MEGA32DS-300	968.090	2	32	80	86	302,5	42	183	80 - 97	62	5000
BBT50-MEGA42DS-105	968.091	1	42	99	100	107	42	-	90 - 107	72	15000
BBT50-MEGA42DS-135	968.092	1	42	99	100	137	42	-	90 - 107	72	15000
BBT50-MEGA42DS-165	968.093	1	42	99	100	167	42	-	90 - 107	72	14000

1. BIG-PLUS® tools can be used in machining centers with non BIG-PLUS® spindles.
2. Wrench and axial adjusting screw are to be ordered separately.
3. As a back stop for cutting tools for MEGA16DS, a commercially available hex socket head screw (M8) can be used.
4. "E" is the min. clamping length.
5. "H" is the max. tool shank length that can be inserted for these models.
6. "G" is the adjusting screw (optional).
7. * Adjustable straight collet (C20-+_CS) and OCA collet cannot be used.

Accessories & Spare Parts

<p>PJC Collets</p>  <p>▶ 347</p>	<p>PSC Collets</p>  <p>▶ 348</p>	<p>C Collets</p>  <p>▶ 349</p>	<p>MEGA Wrenches</p>  <p>▶ 351</p>	<p>Adjusting Screws HMA</p>  <p>▶ 350</p>
---	---	---	---	--

MEGA Perfect Grip

100% security against pulling out of the cutting tool under any torque load.

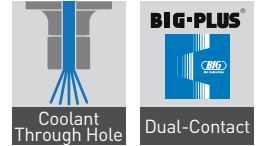

A.1

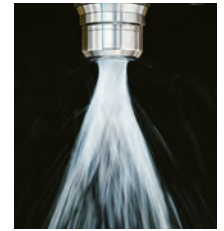
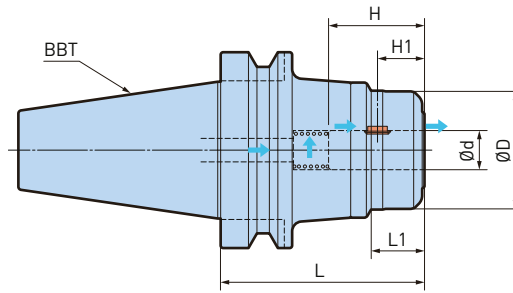

ø16 - 32mm

Model	Order No.	Ød	ØD	L	L1	H	H1
BBT40-MEGA16DPG-75	806.362	16	46	75	24	47	23
BBT40-MEGA20DPG-100	806.363	20	60	100	27	49	24
BBT50-MEGA16DPG-105	805.449	16	46	105	24	47	23
BBT50-MEGA16DPG-165	805.450	16	46	165	24	47	23
BBT50-MEGA20DPG-105	805.451	20	60	105	27	49	24
BBT50-MEGA20DPG-165	805.452	20	60	165	27	49	24
BBT50-MEGA25DPG-105	805.453	25	70	105	33	55	23
BBT50-MEGA25DPG-165	805.454	25	70	165	33	55	23
BBT50-MEGA32DPG-105	805.455	32	80	105	41	59	23
BBT50-MEGA32DPG-165	805.456	32	80	165	41	59	23

1. BIG-PLUS® tools can be used in machining centers with non BIG-PLUS® spindles.
2. Key grip and spring are included with each holder.
3. MEGA wrench is to be ordered separately.
4. „H1“ shows distance from center of key grip to front end.

Weldon Shank Standards

(DIN 1835-1)

The following standard shank is required for MEGA Perfect Grip.



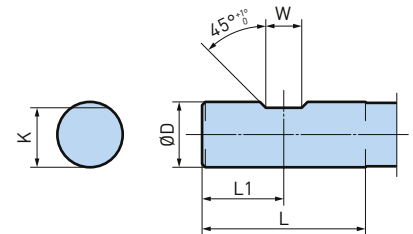

Ø 25/32 mm

Ø 20 mm

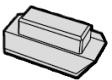

ØD		L	L1	W		K	
Nominal	Tolerance			Nominal	Tolerance	Nominal	Tolerance
16	h6	48	24	10	+ 0.05 0	14.2	h13
20		50	25	11		18.2	
25		56	32	12		23	
32		60	36	14		30	

Accessories & Spare Parts

<p>Key Grip MEGA Perfect Grip</p>  <p>▶ 350</p>	<p>Spring MEGA Perfect Grip</p>  <p>▶ 350</p>	<p>MEGA Wrenches</p>  <p>▶ 351</p>
--	--	---

New Baby Chuck

The original high precision collet chuck to perform all machining applications.

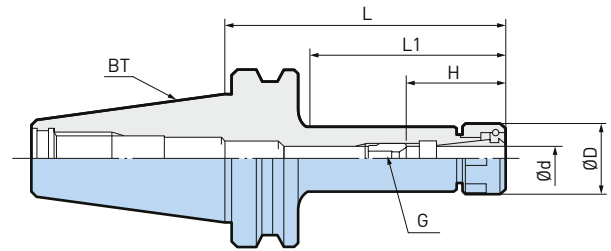

A.1

ø0.25 - 20mm

Model	Order No.	Ød	ØD	L	L1	H	Collet Model	Nut Model
BT30-NBS6-60	961.917	• 0.25 - 6	20	60	32	20 - 40	NBC6	NBN6
BT30-NBS6-75	961.902	0.25 - 6	20	75	47	20 - 40	NBC6	NBN6
BT30-NBS6-90	961.918	• 0.25 - 6	20	90	62	20 - 40	NBC6	NBN6
BT30-NBS6-105	961.903	0.25 - 6	20	105	77	20 - 40	NBC6	NBN6
BT30-NBS6-120	800.031	0.25 - 6	20	120	90	20 - 40	NBC6	NBN6
BT30-NBS8-60	961.919	0.5 - 8	25	60	33	23 - 42	NBC8	NBN8
BT30-NBS8-90	961.920	0.5 - 8	25	90	63	23 - 42	NBC8	NBN8
BT30-NBS10-60	961.921	1.5 - 10	30	60	34	35 - 45	NBC10	NBN10
BT30-NBS10-75	961.908	1.5 - 10	30	75	49	35 - 45	NBC10	NBN10
BT30-NBS10-90	961.922	1.5 - 10	30	90	64	35 - 45	NBC10	NBN10
BT30-NBS10-105	961.909	1.5 - 10	30	105	79	35 - 45	NBC10	NBN10
BT30-NBS10-120	800.597	1.5 - 10	30	120	94	35 - 45	NBC10	NBN10
BT30-NBS13-60	961.923	2.5 - 13	35	60	34	41 - 60	NBC13	NBN13
BT30-NBS13-90	961.924	• 2.5 - 13	35	90	64	41 - 60	NBC13	NBN13
BT30-NBS16-60	961.925	2.5 - 16	42	60	37	45 - 65	NBC16	NBN16
BT30-NBS16-90	961.926	2.5 - 16	42	90	67	45 - 65	NBC16	NBN16
BT30-NBS20-60	961.915	2.5 - 20	46	60	38	48 - 58	NBC20	NBN20
BT30-NBS20-90	961.916	2.5 - 20	46	90	68	48 - 65	NBC20	NBN20
BT30-NBS20-120	800.029	2.5 - 20	46	120	98	48 - 65	NBC20	NBN20
BT40-NBS6-90	961.932	• 0.25 - 6	20	90	53	20 - 40	NBC6	NBN6
BT40-NBS6-135	961.933	0.25 - 6	20	135	98	20 - 40	NBC6	NBN6
BT40-NBS8-90	961.935	0.5 - 8	25	90	53	23 - 42	NBC8	NBN8
BT40-NBS8-135	961.936	0.5 - 8	25	135	98	23 - 42	NBC8	NBN8
BT40-NBS10-90	961.938	1.5 - 10	30	90	53	35 - 45	NBC10	NBN10
BT40-NBS10-120	968.604	1.5 - 10	30	120	83	35 - 45	NBC10	NBN10
BT40-NBS10-135	961.939	1.5 - 10	30	135	98	35 - 45	NBC10	NBN10
BT40-NBS13-90	961.941	• 2.5 - 13	35	90	55	41 - 60	NBC13	NBN13
BT40-NBS13-135	961.942	2.5 - 13	35	135	100	41 - 60	NBC13	NBN13
BT40-NBS16-90	961.944	2.5 - 16	42	90	55	45 - 65	NBC16	NBN16
BT40-NBS16-120	968.610	2.5 - 16	42	120	85	45 - 65	NBC16	NBN16
BT40-NBS16-135	961.945	2.5 - 16	42	135	100	45 - 65	NBC16	NBN16
BT40-NBS20-60	961.946	2.5 - 20	46	60	28	48 - 65	NBC20	NBN20
BT40-NBS20-75	968.611	2.5 - 20	46	75	42	48 - 65	NBC20	NBN20
BT40-NBS20-90	961.947	• 2.5 - 20	46	90	57	48 - 65	NBC20	NBN20
BT40-NBS20-120	968.613	2.5 - 20	46	120	87	48 - 65	NBC20	NBN20
BT40-NBS20-135	961.948	2.5 - 20	46	135	102	48 - 65	NBC20	NBN20
BT40-NBS20-165	961.959	2.5 - 20	46	165	132	48 - 65	NBC20	NBN20

continues on the next page



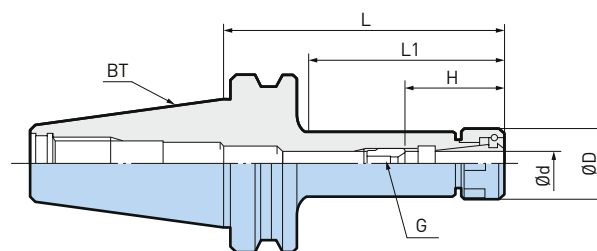

Model	Order No.	Ød	ØD	L	L1	H	Collet Model	Nut Model
BT50-NBS6-120	961.962	0.25 - 6	20	120	67	20 - 40	NBC6	NBN6
BT50-NBS6-165	961.963	0.25 - 6	20	165	112	20 - 40	NBC6	NBN6
BT50-NBS6-200	961.964	0.25 - 6	20	200	147	20 - 40	NBC6	NBN6
BT50-NBS8-120	961.966	0.5 - 8	25	120	67	23 - 42	NBC8	NBN8
BT50-NBS8-165	961.967	0.5 - 8	25	165	112	23 - 42	NBC8	NBN8
BT50-NBS10-120	961.970	1.5 - 10	30	120	67	35 - 45	NBC10	NBN10
BT50-NBS10-165	961.971	1.5 - 10	30	165	112	35 - 45	NBC10	NBN10
BT50-NBS10-200	961.972	1.5 - 10	30	200	147	35 - 45	NBC10	NBN10
BT50-NBS13-90	961.975	2.5 - 13	35	90	42	41 - 60	NBC13	NBN13
BT50-NBS13-120	961.976	2.5 - 13	35	120	67	41 - 60	NBC13	NBN13
BT50-NBS13-165	961.977	2.5 - 13	35	165	112	41 - 60	NBC13	NBN13
BT50-NBS13-200	961.978	2.5 - 13	35	200	147	41 - 60	NBC13	NBN13
BT50-NBS16-120	961.983	2.5 - 16	42	120	72	45 - 65	NBC16	NBN16
BT50-NBS16-165	961.984	2.5 - 16	42	165	117	45 - 65	NBC16	NBN16
BT50-NBS16-200	961.985	2.5 - 16	42	200	152	45 - 65	NBC16	NBN16
BT50-NBS20-90	961.988	2.5 - 20	46	90	42	48 - 65	NBC20	NBN20
BT50-NBS20-120	961.989	2.5 - 20	46	120	72	48 - 65	NBC20	NBN20
BT50-NBS20-165	961.990	2.5 - 20	46	165	117	48 - 65	NBC20	NBN20
BT50-NBS20-200	961.991	2.5 - 20	46	200	152	48 - 65	NBC20	NBN20
BT50-NBS20-250 *	961.992	2.5 - 20	46	250	202	48 - 65	NBC20	NBN20

1. New Baby Nut is included.
2. Max. 20 000 min-1 is valid for L = 60 and 90 mm.
3. * Center through coolant is not available.
4. "H" is the max. tool shank length that can be inserted for these models.
5. "G" is the adjusting screw (optional).

Accessories & Spare Parts

<p>New Baby Nuts</p>  <p>▶ 334</p>	<p>Baby Perfect Seals</p>  <p>▶ 338</p>	<p>New Baby Collets</p>  <p>▶ 327</p>	<p>New Baby Wrenches</p>  <p>▶ 352</p>	<p>Adjusting Screws NBA</p>  <p>▶ 335</p>	<p>Tap Driving Back Stops</p>  <p>▶ 335</p>	<p>Taper Cleaners</p>  <p>▶ 370</p>
---	--	--	---	---	--	--

New Baby Chuck Type NRA

New Baby Chuck holder with runout adjustable tool function.

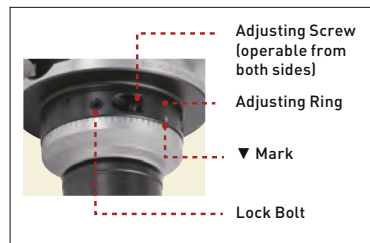
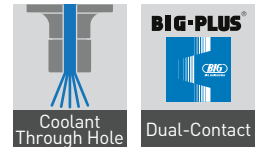

Simple structure for easy adjustment

1. Turn the adjusting ring and line up the ▼ mark with peak runout position.
2. Adjust the lock bolts in 3 locations to fix the ring.
3. The runout amount is adjusted by tightening the adjusting screw.

A.1

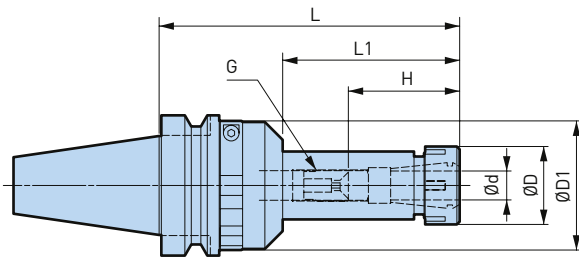

Fig. 1

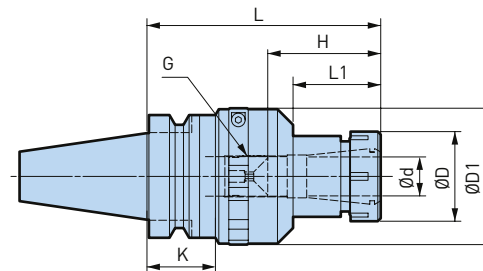

Fig. 2

ø0.5 - 20mm

Model	Order No.	Fig.	Ød	ØD	ØD1	L	L1	K	H	Collet Model	Nut Model	Adjustment l=50	Adjustment l=100
BBT30-NBS8-75NRA	806.259	1	0.5 - 8	25	45	75	28	-	23 - 42	NBC8	NBN8	20 µm	31 µm
BBT30-NBS13-110NRA	806.260	2	2.5 - 13	35	58	110	34	35	41 - 60	NBC13	NBN13	18 µm	27 µm
BBT40-NBS8-90NRA	806.261	1	0.5 - 8	25	45	90	37	-	23 - 42	NBC8	NBN8	22 µm	33 µm
BBT40-NBS13-90NRA	806.262	1	2.5 - 13	35	58	90	34	-	41 - 60	NBC13	NBN13	18 µm	27 µm
BBT40-NBS13-135NRA	806.263	1	2.5 - 13	35	58	135	79	-	41 - 60	NBC13	NBN13	25 µm	34 µm
BBT40-NBS20-120NRA	804.693	2	2.5 - 20	46	70	120	45	35	48 - 65	NBC20	NBN20	17 µm	25 µm
BBT40-NBS20-150NRA	806.264	2	2.5 - 20	46	70	150	65	45	48 - 65	NBC20	NBN20	21 µm	29 µm
BBT50-NBS13-105NRA	804.697	1	2.5 - 13	35	58	105	38	-	41 - 60	NBC13	NBN13	19 µm	28 µm
BBT50-NBS13-135NRA	804.698	1	2.5 - 13	35	58	135	68	-	41 - 60	NBC13	NBN13	24 µm	33 µm
BBT50-NBS13-165NRA	806.265	1	2.5 - 13	35	58	165	98	-	41 - 60	NBC13	NBN13	30 µm	39 µm
BBT50-NBS20-120NRA	804.699	1	2.5 - 20	46	70	120	48	-	48 - 65	NBC20	NBN20	17 µm	25 µm
BBT50-NBS20-150NRA	804.700	1	2.5 - 20	46	70	150	78	-	48 - 65	NBC20	NBN20	22 µm	30 µm

1. Nut is included.
2. Collet, wrench and adjusting screw need to be ordered separately.
3. "H" is the max. tool shank length that can be inserted for these models.
4. The adjustment amount depends on the length of the holder and the tool projection length. The maximum adjustment amount for tool projection lengths of 50 mm and 100 mm is shown in the table.

Accessories & Spare Parts

<p>New Baby Collets</p> <p>▶ 327</p>	<p>New Baby Nuts</p> <p>▶ 334</p>	<p>Baby Perfect Seals</p> <p>▶ 338</p>	<p>New Baby Wrenches</p> <p>▶ 352</p>
--------------------------------------	-----------------------------------	--	---------------------------------------

New Hi-Power Milling Chuck Type S

The original design assures heavy machining with high power and precision.

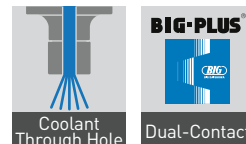

A.1



ø3 - 42mm

Model	Order No.	Fig.	Ød	ØD	L	L1	H	E	E1
BBT30-HMC16S-70 *	964.101S	1	16	43	70	47	71	48	55
BBT30-HMC20S-75	964.102S	2	20	50	75	-	56 - 66	50	56
BBT30-HMC25S-90	964.103S	2	25	55	90	-	64 - 74	56	57
BBT30-HMC32S-105	978.181S	2	32	62	105	-	70 - 80	60	58
BBT40-HMC16S-75 *	964.190S	1	16	43	75	45	71	48	55
BBT40-HMC16S-120 *	800.144	1	16	43	120	90	71	48	55
BBT40-HMC20S-75	964.191S •	1	20	50	75	46	69 - 79	50	56
BBT40-HMC20S-105	964.194S	1	20	50	105	75	69 - 79	50	56
BBT40-HMC20S-120	964.196S	1	20	50	120	90	69 - 79	50	56
BBT40-HMC25S-75	964.192S	1	25	59	75	47	73 - 83	56	57
BBT40-HMC25S-105	964.195S	1	25	59	105	77	73 - 83	56	57
BBT40-HMC25S-135	800.146	1	25	59	135	107	73 - 83	56	57
BBT40-HMC32S-90	978.279S	2	32	68	90	-	71 - 81	60	64
BBT40-HMC32S-105	800.147 •	2	32	68	105	-	79 - 89	60	64
BBT40-HMC32S-135	800.148	2	32	68	135	-	79 - 89	60	64

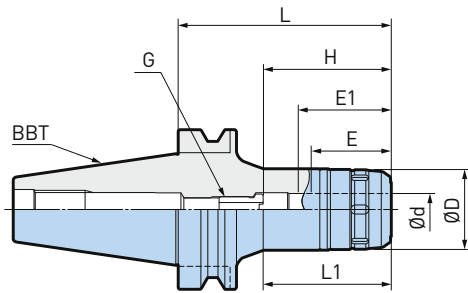

Fig. 1

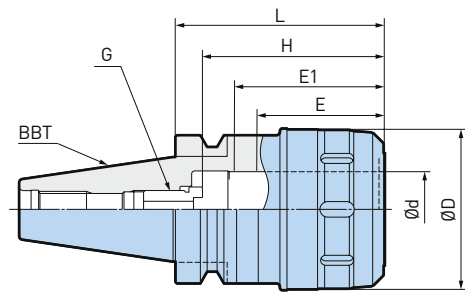

Fig. 2

Model	Order No.	Fig.	Ød	ØD	L	L1	H	E	E1
BBT50-HMC16S-105 *	800.278	1	16	43	105	57	71	48	55
BBT50-HMC16S-135 *	800.279	1	16	43	135	80	71	48	55
BBT50-HMC16S-165 *	800.280	1	16	43	165	100	71	48	55
BBT50-HMC16S-200 *	800.281	1	16	43	200	120	71	48	55
BBT50-HMC20S-105	800.282	1	20	50	105	57	69 - 79	50	56
BBT50-HMC20S-135	800.283	1	20	50	135	80	69 - 79	50	56
BBT50-HMC20S-165	800.284	1	20	50	165	100	69 - 79	50	56
BBT50-HMC20S-200	800.285	1	20	50	200	125	69 - 79	50	56
BBT50-HMC20S-300	800.286	1	20	50	300	200	69 - 79	50	56
BBT50-HMC25S-105	800.287	1	25	59	105	57	76 - 86	56	57
BBT50-HMC25S-135	800.288	1	25	59	135	87	76 - 86	56	57
BBT50-HMC25S-165	800.289	1	25	59	165	105	76 - 86	56	57
BBT50-HMC25S-200	800.290	1	25	59	200	125	76 - 86	56	57
BBT50-HMC32S-105	800.291	1	32	68	105	64	88 - 98	60	72
BBT50-HMC32S-135	800.292	1	32	68	135	89	88 - 98	60	72
BBT50-HMC32S-165	800.293	1	32	68	165	105	88 - 98	60	72
BBT50-HMC32S-200	800.294	1	32	68	200	130	88 - 98	60	72
BBT50-HMC32S-300	800.295	1	32	68	300	200	88 - 98	60	72
BBT50-HMC42S-105	806.709	1	42	85	105	65	93 - 105	70	73
BBT50-HMC42S-165	805.773	1	42	85	165	123	93 - 105	70	73
BBT50-HMC42S-300	807.003	1	42	85	300	200	93 - 105	70	73

1. BIG-PLUS® tools can be used in machining centers with non BIG-PLUS® spindles.
2. Wrench and axial adjusting screw are to be ordered separately.
3. * As a back stop for cutting tools for the HMC16S models, a commercially available hex socket head screw [M8] can be used.
4. "H" is the max. tool shank length that can be inserted for these models.
5. "G" is the adjusting screw (optional).
6. "E" is the min. clamping length.
7. "E1" is the min. clamping length for optimum use with center through coolant.

Accessories & Spare Parts

<p>PJC Collets</p>  <p>▶ 347</p>	<p>OCA Collets</p>  <p>▶ 348</p>	<p>PSC Collets</p>  <p>▶ 348</p>	<p>C Collets</p>  <p>▶ 349</p>	<p>FK Wrenches</p>  <p>▶ 352</p>	<p>Adjusting Screws HMA</p>  <p>▶ 350</p>
---	---	---	---	---	--

New Hi-Power Milling Chuck Type HMC12J

Extremely slim and rigid design with jet through coolant.

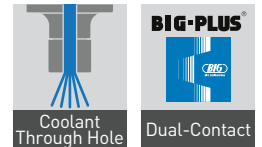

A.1

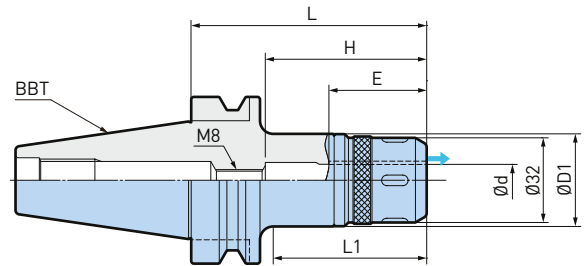



ø6 - 12mm

Model	Order No.	Ød	ØD1	L	L1	H	E
BBT30-HMC12J-60	805.814	12	35	60	38	65	43
BBT40-HMC12J-90	805.815	12	35	90	63	65	43
BBT40-HMC12J-120	805.816	12	35	120	70	65	43
BBT50-HMC12J-105	805.817	12	35	105	67	65	43
BBT50-HMC12J-135	805.818	12	35	135	70	65	43
BBT50-HMC12J-165	805.819	12	35	165	90	65	43

1. BIG-PLUS® tools can be used in machining centers with non BIG-PLUS® spindles.
2. Wrench is to be ordered separately.
3. "H" is the max. tool shank length that can be inserted for these models.
4. "E" is the min. clamping length.



Accessories & Spare Parts

<p>PJC Collets</p>  <p>▶ 347</p>	<p>FK Wrenches</p>  <p>▶ 352</p>	<p>Adjusting Screws HMA</p>  <p>▶ 350</p>
---	---	--

New Hi-Power Milling Chuck Type NRA

New Hi-Power Milling Chuck with runout adjustable function.

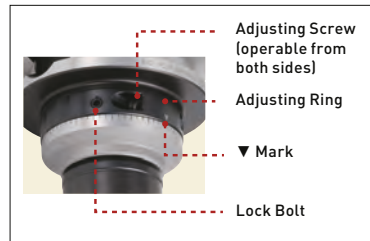
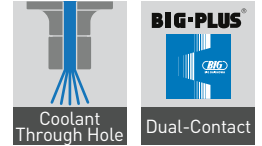

Simple structure for easy adjustment

1. Turn the adjusting ring and line up the ▼ mark with peak runout position.
2. Adjust the lock bolts in 3 locations to fix the ring.
3. The runout amount is adjusted by tightening the adjusting screw.

A.1

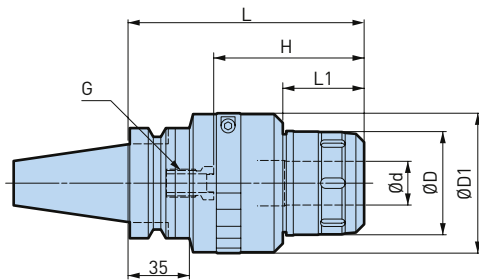

Fig. 1

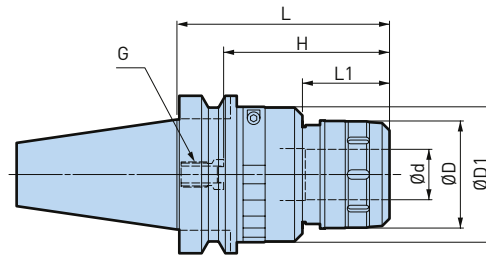

Fig. 2

ø3 - 32mm

Model	Order No.	Fig.	Ød	ØD	ØD1	L	L1	H	Adjustment l=50	Adjustment l=100
BBT40-HMC20S-130NRA	806.164	1	20	50	72	130	46	69 - 79	23 µm	33 µm
BBT40-HMC25S-135NRA	804.690	1	25	59	80	135	46	75 - 85	21 µm	30 µm
BBT40-HMC32S-145NRA	804.691	1	32	68	86	145	55	85 - 95	20 µm	28 µm
BBT50-HMC20S-125NRA	806.270	2	20	50	72	125	46	69 - 79	23 µm	33 µm
BBT50-HMC25S-125NRA	806.271	2	25	59	80	125	46	75 - 85	21 µm	30 µm
BBT50-HMC32S-135NRA	806.272	2	32	68	86	135	55	85 - 95	20 µm	28 µm

1. Wrench and axial adjusting screw are to be ordered separately.
2. "H" is the max. tool shank length that can be inserted for these models.
3. The adjustment amount depends on the length of the holder and the tool projection length. The maximum adjustment amount for tool projection lengths of 50 mm and 100 mm is shown in the table.

Accessories & Spare Parts

<p>FK Wrenches</p> <p>▶ 352</p>	<p>Adjusting Screws HMA</p> <p>▶ 350</p>	<p>PJC Collets</p> <p>▶ 347</p>	<p>PSC Collets</p> <p>▶ 348</p>	<p>OCA Collets</p> <p>▶ 348</p>	<p>C Collets</p> <p>▶ 349</p>
---------------------------------	--	---------------------------------	---------------------------------	---------------------------------	-------------------------------

Hydraulic Chuck Super Slim

Ultra precise hydraulic chuck with extremely slim design.

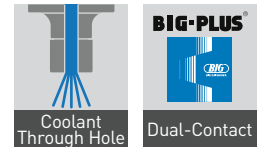

A.1



ø3 - 12mm

Model	Order No.	Fig.	Ød	ØD	ØD1	ØD2	L	L1	L2	E
BBT30-HDC3S-60 *	807.580	1	3	14	42	18	60	19	-	16
BBT30-HDC3S-90 *	805.462	1	3	14	42	25	90	50	-	16
BBT30-HDC4S-60	803.053	1	4	14	46	20	60	28	-	19
BBT30-HDC4S-90	805.820	1	4	14	42	25	90	50	-	19
BBT30-HDC5S-90	805.821	1	5	14	42	25	90	50	-	22
BBT30-HDC6S-60	807.582	1	6	14	42	25	90	50	-	25
BBT30-HDC6S-90	803.054	1	6	14	42	25	90	50	-	25
BBT30-HDC8S-90	803.055	1	8	17	42	28	90	50	-	31
BBT30-HDC10S-90	803.051	1	10	19	44	30	90	50	-	33
BBT30-HDC12S-90	803.052	1	12	21	46	32	90	50	-	36
BBT40-HDC3S-90 *	805.463	1	3	14	38	24	90	44	-	16
BBT40-HDC4S-60	803.060	1	4	14	38	19	60	22	-	19
BBT40-HDC4S-90	803.061	1	4	14	38	24	90	45	-	19
BBT40-HDC4S-135	805.464	2	4	14	44	26	135	57	84	19
BBT40-HDC5S-90	807.583	1	5	14	38	24	90	46	-	21
BBT40-HDC6S-110	803.062	1	6	14	38	27	110	60	-	25
BBT40-HDC6S-150	803.063	2	6	14	48	26	150	57	85	25
BBT40-HDC8S-110	803.064	1	8	17	40	30	110	60	-	31
BBT40-HDC8S-150	803.065	2	8	17	50	28	150	52	85	31
BBT40-HDC10S-110	803.056	1	10	19	42	32	110	60	-	33
BBT40-HDC10S-150	803.057	2	10	19	50	30	150	52	85	33
BBT40-HDC12S-110	803.058	1	12	21	44	34	110	60	-	36
BBT40-HDC12S-150	803.059	2	12	21	50	32	150	52	85	36

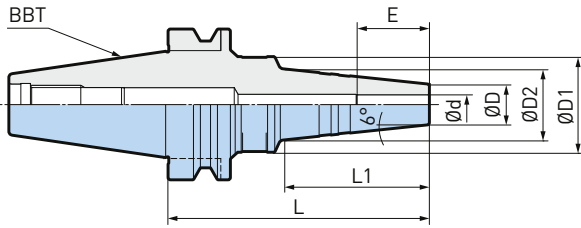

Fig. 1

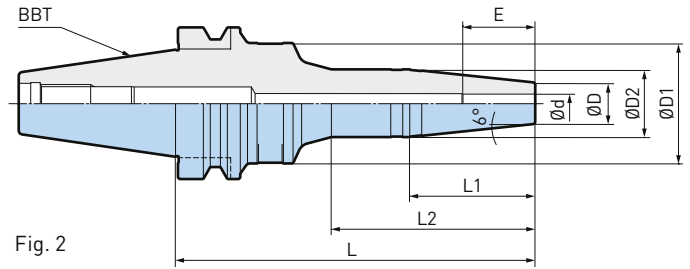

Fig. 2

Model	Order No.	Fig.	Ød	ØD	ØD1	ØD2	L	L1	L2	E
BBT50-HDC4S-150	807.232	2	4	14	52	26	150	57	83	19
BBT50-HDC4S-200	807.584	1	4	14	56	26	200	57	100	19
BBT50-HDC6S-150	803.068	2	6	14	52	26	150	57	83	25
BBT50-HDC6S-200	805.822	2	6	14	56	26	200	57	100	25
BBT50-HDC8S-150	803.069	2	8	17	54	28	150	52	83	31
BBT50-HDC8S-200	805.823	2	8	17	58	28	200	52	100	31
BBT50-HDC10S-150	803.066	2	10	19	56	30	150	52	83	33
BBT50-HDC10S-200	805.824	2	10	19	60	30	200	52	100	33
BBT50-HDC12S-150	803.067	2	12	21	58	32	150	52	83	36
BBT50-HDC12S-200	805.825	2	12	21	62	32	200	52	100	36

1. BIG-PLUS® tools can be used in machining centers with non BIG-PLUS® spindles.
2. Adjusting screw and reduction collet can not be used.
3. "E" is the min. clamping length.
4. * Some coolant may leak from the inner diameter slits when using coolant.

Caution

- Use only cutting tools that have a shank tolerance within h6.
- Roughing endmills are not recommended for use with hydraulic chucks.
- Do not use with cutting tools made with a flat on the shank. (ie: Weldon type shank)
- Do not tighten the clamping screw without first inserting a cutting tool into the hydraulic chuck.
- Always insert the cutting tool into the hydraulic chuck beyond min. clamping length E.

Accessories & Spare Parts

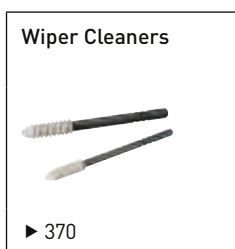

Hydraulic Chuck Jet Through

Coolant or Minimum Quantity Lubrication is supplied to cutting edge securely. Maximum performance and high-precision with 5-axis machining.

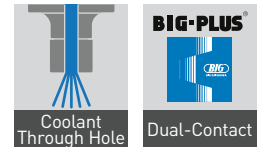

A.1

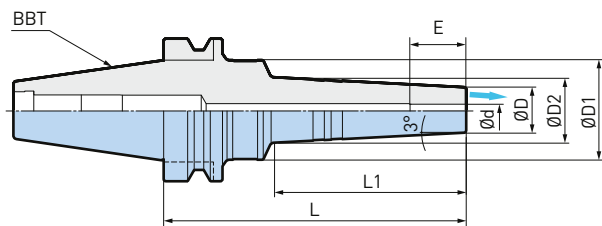

Fig. 1

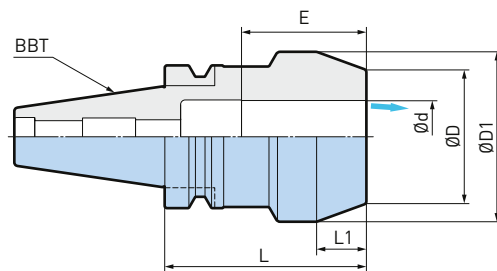
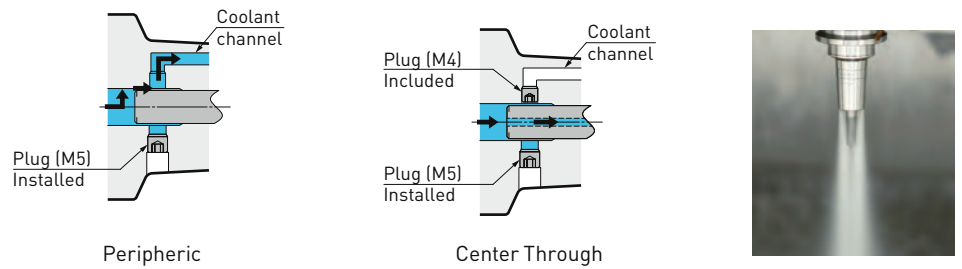

Fig. 2

ø4 - 32mm

Model	Order No.	Fig.	Ød	ØD	ØD1	ØD2	L	L1	E
BBT30-HDC4J-60	805.077	1	4	20	46	23	60	28	19
BBT30-HDC4J-90	807.372	1	4	20	42	26	90	50	19
BBT30-HDC6J-90	805.078	1	6	20	42	26	90	50	25
BBT30-HDC8J-90	805.079	1	8	22	42	28	90	50	31
BBT30-HDC10J-90	805.080	1	10	24	44	30	90	50	33
BBT30-HDC12J-90	805.081	1	12	26	46	32	90	50	36
BBT30-HDC16J-90	805.480	1	16	34	46	40	90	49	43
BBT30-HDC20J-90	805.481	1	20	38	52	43	90	40	43
BBT40-HDC4J-90	805.082	1	4	20	38	25	90	45	19
BBT40-HDC4J-135	805.549	1	4	20	44	30	135	85	19
BBT40-HDC6J-90	805.083	1	6	20	38	25	90	45	25
BBT40-HDC6J-135	805.084	1	6	20	44	29	135	85	25
BBT40-HDC8J-90	805.085	1	8	22	40	27	90	45	31
BBT40-HDC8J-135	805.086	1	8	22	46	31	135	85	31
BBT40-HDC10J-90	805.087	1	10	24	42	29	90	45	33
BBT40-HDC10J-135	805.088	1	10	24	48	33	135	85	33
BBT40-HDC12J-90	805.089	1	12	26	44	31	90	45	36
BBT40-HDC12J-135	805.090	1	12	26	50	35	135	85	36
BBT40-HDC16J-90	805.482	1	16	34	46	40	90	46	43
BBT40-HDC16J-135	805.483	1	16	34	50	44	135	89	43
BBT40-HDC20J-90	805.484	1	20	38	48	44	90	47	43
BBT40-HDC20J-135	805.485	1	20	38	53	48	135	90	43
BBT40-HDC25J-90	805.677	1	25	51	63	56	90	41	49
BBT40-HDC32J-90	805.678	2	32	59	75	-	90	20	56



Model	Order No.	Fig.	Ød	ØD	ØD1	ØD2	L	L1	E
BBT50-HDC6J-120	805.091	1	6	20	48	26	120	55	25
BBT50-HDC8J-120	805.092	1	8	22	50	28	120	55	31
BBT50-HDC10J-120	805.093	1	10	24	52	30	120	55	33
BBT50-HDC12J-120	805.094	1	12	26	54	32	120	55	36
BBT50-HDC16J-120	805.486	1	16	34	58	41	120	56	43
BBT50-HDC20J-120	805.487	1	20	38	62	45	120	56	43
BBT50-HDC25J-120	805.679	1	25	48	70	58	120	59	49
BBT50-HDC32J-120	805.680	1	32	58	78	67	120	60	56
BBT50-HDC32J-120	805.680	1	32	58	78	67	120	60	56

1. BIG-PLUS® tools can be used in machining centers with non BIG-PLUS® spindles.
2. Straight collet can be used for HDC16J & 20J size models.
3. Adjusting screw cannot be used.
4. Larger diameter models, HDC16J or bigger are only available with peripheral coolant supply.
5. "E" is the min. clamping length.

Caution

- Use only cutting tools that have a shank tolerance within h6.
- Roughing endmills are not recommended for use with hydraulic chucks.
- Do not use with cutting tools made with a flat on the shank. (ie: Weldon type shank)
- Do not tighten the clamping screw without first inserting a cutting tool into the hydraulic chuck.
- Always insert the cutting tool into the hydraulic chuck beyond min. clamping length E.

Accessories & Spare Parts

<p>PJC Collets</p>  <p>▶ 347</p>	<p>PSC Collets</p>  <p>▶ 348</p>	<p>Wiper Cleaners</p>  <p>▶ 370</p>
---	---	--

Hydraulic Chuck Standard

For high precision machining in automotive, aerospace, medical and die & mold.

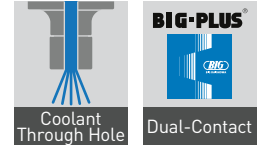

A.1

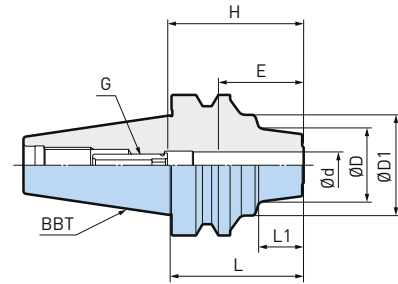

Fig. 1

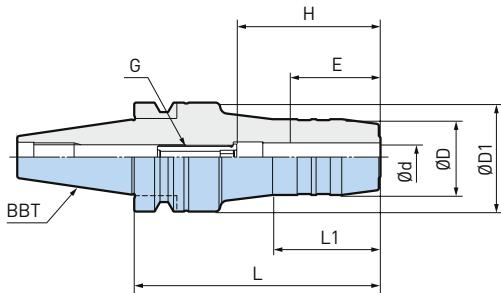

Fig. 2

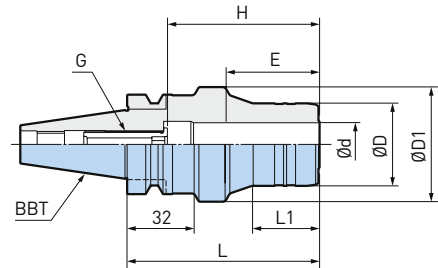

Fig. 3

ø3 - 31mm

Model	Order No.	Fig.	Ød	ØD	ØD1	L	L1	L2	H	E	G
BBT30-HDC6-45	978.071	1	6	30	46	45	7	-	35 - 50	28	HDA6-05020
BBT30-HDC6-75	978.034	2	6	26	46	75	40	-	28 - 50	28	HDA6-05032
BBT30-HDC6-90	978.072	2	6	26	46	90	42	57	28 - 50	28	HDA6-05032
BBT30-HDC6-105	978.073	2	6	26	46	105	43	-	28 - 50	28	HDA6-05032
BBT30-HDC7-75	978.074	2	7	27	46	75	41	-	28 - 50	28	HDA6-05032
BBT30-HDC8-45	978.075	2	8	32	46	45	7	-	35 - 50	28	HDA8-06020
BBT30-HDC8-75	978.076	2	8	28	46	75	41	-	28 - 50	28	HDA8-06032
BBT30-HDC8-90	978.077	2	8	28	46	90	44	57	28 - 50	28	HDA6-05032
BBT30-HDC8-105	978.078	2	8	28	46	105	44	-	28 - 50	28	HDA8-06032
BBT30-HDC9-75	978.079	2	9	29	46	75	41	-	28 - 50	28	HDA8-06032
BBT30-HDC10-45	978.080	1	10	34	46	45	7	-	45 - 55	33	HDA10-08015
BBT30-HDC10-75	978.081	2	10	30	46	75	36	-	33 - 55	33	HDA10-08032
BBT30-HDC10-90	978.082	2	10	30	46	90	45	51	33 - 55	33	HDA10-08032
BBT30-HDC10-105	978.083	2	10	30	46	105	45	-	33 - 55	33	HDA10-08032
BBT30-HDC11-90	978.084	2	11	31	46	90	51	45	33 - 55	33	HDA10-08032
BBT30-HDC12-45	978.085	1	12	36	46	45	7	-	55 - 60	38	HDA12-10010
BBT30-HDC12-75	978.086	2	12	32	46	75	36	-	38 - 60	38	HDA12-10032
BBT30-HDC12-90	978.087	2	12	32	46	90	45	51	38 - 60	38	HDA12-10032
BBT30-HDC12-105	978.088	2	12	32	46	105	45	-	38 - 60	38	HDA12-10032
BBT30-HDC13-90	978.089	2	13	33	46	90	45	51	38 - 60	38	HDA12-10032
BBT30-HDC14-90	978.090	2	14	34	46	90	46	52	38 - 60	38	HDA12-10032
BBT30-HDC15-90	978.091	2	15	37	46	90	47	-	43 - 70	43	HDA12-10032
BBT30-HDC16-45 *	978.092	1	16	42	46	45	7	-	70 - 70	43	-
BBT30-HDC16-75	978.025	2	16	38	46	75	35	-	43 - 70	43	HDA16-12030
BBT30-HDC16-90	978.093	2	16	38	46	90	47	-	43 - 70	43	HDA16-12037
BBT30-HDC16-105	805.550	2	16	38	46	105	47	-	43 - 70	43	HDA16-12037
BBT30-HDC18-90	978.094	2	18	36	51	90	31	41	43 - 70	43	HDA16-12037
BBT30-HDC20-60 **	978.095	3	20	38	53	60	-	32	43 - 54	43	HDA16-12030
BBT30-HDC20-75	978.038	3	20	38	53	75	16	32	46 - 70	43	HDA16-12030
BBT30-HDC20-90	978.096	2	20	38	38	90	31	41	43 - 70	43	HDA16-12037
BBT30-HDC20-105	805.551	2	20	38	46	105	40	-	43 - 70	43	HDA16-12037
BBT30-HDC25-105	978.097	3	25	55	63	105	44	32	52 - 80	52	HDA25-16039
BBT30-HDC32-105	978.098	2	32	60	75	105	39	-	56 - 80	56	HDA25-16039

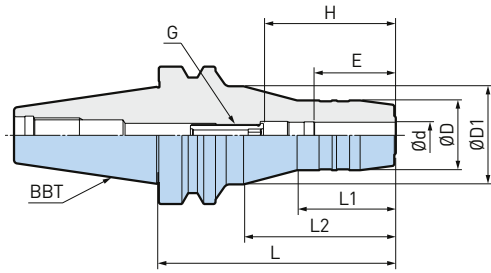

Fig. 4

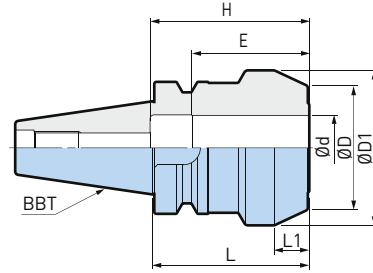

Fig. 5

Model	Order No.	Fig.	Ød	ØD	ØD1	L	L1	L2	H	E	G
BBT40-HDC6-60	800.131	1	6	27	45	60	19	-	28 - 50	28	HDA6-05032
BBT40-HDC6-90	978.343	4	6	26	45	90	44	50	28 - 50	28	HDA6-05032
BBT40-HDC6-110	800.128	4	6	26	45	110	44	70	28 - 50	28	HDA6-05032
BBT40-HDC6-135	800.129	4	6	26	45	135	44	-	28 - 50	28	HDA6-05032
BBT40-HDC6-165	800.130	4	6	26	45	165	44	-	28 - 50	28	HDA6-05032
BBT40-HDC7-90	800.135	4	7	27	45	90	44	-	28 - 50	28	HDA6-05032
BBT40-HDC8-60	800.139	1	8	29	45	60	19	-	28 - 50	28	HDA8-06032
BBT40-HDC8-90	978.192	4	8	28	45	90	44	50	28 - 50	28	HDA8-06032
BBT40-HDC8-110	800.136	4	8	28	45	110	44	-	28 - 50	28	HDA8-06032
BBT40-HDC8-135	800.137	4	8	28	45	135	44	-	28 - 50	28	HDA8-06032
BBT40-HDC8-165	800.138	4	8	28	45	165	44	-	28 - 50	28	HDA8-06032
BBT40-HDC9-90	800.143	4	9	29	45	90	45	-	28 - 50	28	HDA8-06032
BBT40-HDC10-60	800.088	1	10	31	45	60	20	-	33 - 55	33	HDA10-08032
BBT40-HDC10-90	978.027	4	10	30	45	90	45	50	33 - 55	33	HDA10-08032
BBT40-HDC10-110	800.085	4	10	30	45	110	45	70	33 - 55	33	HDA10-08032
BBT40-HDC10-135	800.086	4	10	30	45	135	45	-	33 - 55	33	HDA10-08032
BBT40-HDC10-165	800.087	4	10	30	45	165	45	-	33 - 55	33	HDA10-08032
BBT40-HDC11-90	800.092	4	11	31	45	90	45	-	33 - 55	33	HDA10-08032
BBT40-HDC12-60	978.046	1	12	33	45	60	20	-	38 - 60	38	HDA12-10032
BBT40-HDC12-90	800.096	4	12	32	45	90	45	49	38 - 60	38	HDA12-10032
BBT40-HDC12-110	800.093	4	12	32	45	110	45	69	38 - 60	38	HDA12-10032
BBT40-HDC12-135	800.094	4	12	32	45	135	45	-	38 - 60	38	HDA12-10032
BBT40-HDC12-165	800.095	4	12	32	45	165	45	-	38 - 60	38	HDA12-10032
BBT40-HDC13-90	800.099	4	13	33	45	90	45	-	38 - 60	38	HDA12-10032
BBT40-HDC14-90	978.028	4	14	34	45	90	46	49	38 - 60	38	HDA12-10032
BBT40-HDC14-110	800.100	4	14	34	45	110	46	-	38 - 60	38	HDA12-10032
BBT40-HDC14-135	800.101	4	14	34	45	135	46	-	38 - 60	38	HDA12-10032
BBT40-HDC15-90	800.104	4	15	37	45	90	47	-	43 - 70	43	HDA16-12037
BBT40-HDC16-75	800.108	4	16	38	45	75	35	-	43 - 70	43	HDA16-12037
BBT40-HDC16-90	978.193	4	16	38	45	90	47	49	43 - 70	43	HDA16-12037
BBT40-HDC16-110	800.105	4	16	38	45	110	47	-	43 - 70	43	HDA16-12037
BBT40-HDC16-135	800.106	4	16	38	45	135	47	-	43 - 70	43	HDA16-12037
BBT40-HDC16-165	800.107	4	16	38	50	165	47	-	43 - 70	43	HDA16-12037
BBT40-HDC18-90	978.194	4	18	40	45	90	48	49	43 - 70	43	HDA16-12037
BBT40-HDC18-110	800.109	4	18	40	45	110	48	-	43 - 70	43	HDA16-12037
BBT40-HDC18-135	800.110	4	18	40	45	135	48	-	43 - 70	43	HDA16-12037
BBT40-HDC19-75 *	800.111	6	19	49.2	-	75	43	-	111	43	-
BBT40-HDC20-90	800.115	4	20	42	45	90	48	50	43 - 70	43	HDA16-12037
BBT40-HDC20-110	800.112	4	20	42	50	110	48	70	43 - 70	43	HDA16-12037
BBT40-HDC20-135	800.113	4	20	42	50	135	48	-	43 - 70	43	HDA16-12037
BBT40-HDC20-165	800.114	4	20	42	50	165	48	-	43 - 70	43	HDA16-12037
BBT40-HDC22-75 *	806.011	6	22	52	-	75	44,5	-	110	56	-
BBT40-HDC24-75 *	800.116	6	24	63	-	75	47	-	104	45	-
BBT40-HDC28-75 *	806.012	5	28	52	56	75	16	-	93	45	-
BBT40-HDC31-75 *	805.826	5	31	74	-	75	30	-	76	56	-

continues on the next page



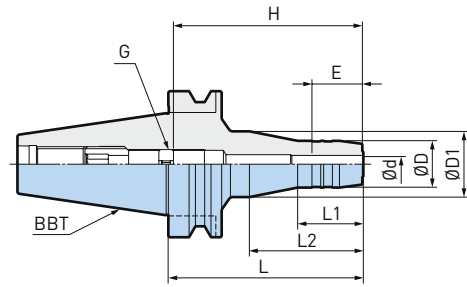
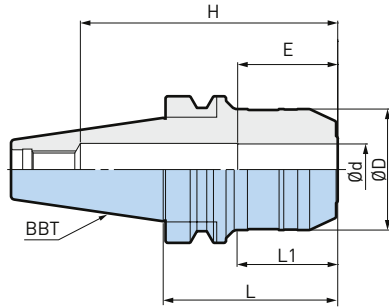

Fig. 6

Fig. 7

Model	Order No.	Fig.	Ød	ØD	ØD1	L	L1	L2	H	E	G
BBT50-HDC6L-105	800.023	7	6	26	45	105	44	48	80 - 120	28	HDA6-20010
BBT50-HDC6L-135	800.024	7	6	26	45	135	44	78	110 - 150	28	HDA6-20010
BBT50-HDC6L-150	800.025	7	6	26	45	150	44	93	125 - 165	28	HDA6-20010
BBT50-HDC6L-165	800.026	7	6	26	45	165	44	108	140 - 180	28	HDA6-20010
BBT50-HDC8L-105	800.027	7	8	28	45	105	45	48	80 - 120	28	HDA6-20010
BBT50-HDC8L-135	800.275	7	8	28	45	135	45	78	110 - 150	28	HDA6-20010
BBT50-HDC8L-150	800.276	7	8	28	45	150	45	93	125 - 165	28	HDA6-20010
BBT50-HDC8L-165	800.277	7	8	28	45	165	45	108	140 - 180	28	HDA6-20010
BBT50-HDC10L-105	800.264	7	10	30	45	105	45	48	80 - 120	33	HDA6-20010
BBT50-HDC10L-135	800.265	7	10	30	45	135	45	78	110 - 150	33	HDA6-20010
BBT50-HDC10L-150	800.266	7	10	30	45	150	45	93	125 - 165	33	HDA6-20010
BBT50-HDC10L-165	800.267	7	10	30	45	165	45	108	140 - 180	33	HDA6-20010
BBT50-HDC12L-105	800.268	7	12	32	45	105	45	48	80 - 120	38	HDA6-20010
BBT50-HDC12L-135	800.269	7	12	32	45	135	45	78	110 - 150	38	HDA6-20010
BBT50-HDC12L-150	800.270	7	12	32	45	150	45	93	125 - 165	38	HDA6-20010
BBT50-HDC12L-165	800.271	7	12	32	45	165	45	108	140 - 180	38	HDA6-20010
BBT50-HDC16L-90	800.000	8	16	38	47	90	40	43	56 - 96	43	HDA20-12047
BBT50-HDC16L-105	800.272	7	16	38	47	105	47	48	80 - 120	43	HDA6-20010
BBT50-HDC16L-135	800.273	7	16	38	47	135	48	78	110 - 150	43	HDA6-20010
BBT50-HDC16L-150	800.274	7	16	38	47	150	48	93	125 - 165	43	HDA6-20010
BBT50-HDC19L-90 *	800.001	6	19	49.2	-	90	45	-	149	43	-
BBT50-HDC20L-90	800.007	8	20	42	50	90	45	-	56 - 96	43	HDA20-12047
BBT50-HDC20L-105	800.002	8	20	42	50	105	47	48	71 - 111	43	HDA20-12047
BBT50-HDC20L-135	800.003	8	20	42	50	135	48	78	101 - 141	43	HDA20-12047
BBT50-HDC20L-150	800.004	8	20	42	50	150	48	93	116 - 156	43	HDA20-12047
BBT50-HDC20L-200	800.005	9	20	42	50	200	48	102	166 - 206	43	HDA20-12047
BBT50-HDC20L-250	800.006	9	20	42	50	250	48	102	216 - 256	43	HDA20-12047
BBT50-HDC22L-90 *	806.013	6	22	52	-	90	45	-	149	43	-
BBT50-HDC24L-90 *	800.008	6	24	63	-	90	41	-	149	45	-
BBT50-HDC25L-90	800.014	8	25	63	-	90	45	-	56 - 96	52	HDA20-12047
BBT50-HDC25L-105	800.009	8	25	63	-	105	60	-	71 - 111	52	HDA20-12047
BBT50-HDC25L-135	800.010	8	25	63	68	135	60	78	101 - 141	52	HDA20-12047
BBT50-HDC25L-150	800.011	8	25	63	70	150	60	92	116 - 156	52	HDA20-12047
BBT50-HDC25L-200	800.012	9	25	63	70	200	60	100	166 - 200	52	HDA20-12047
BBT50-HDC25L-250 *	800.013	9	25	63	70	250	60	100	200	52	-
BBT50-HDC28L-90 *	806.014	6	28	69	-	90	44	-	148	45	-
BBT50-HDC31L-90 *	800.015	6	31	72	-	90	45	-	147	56	-

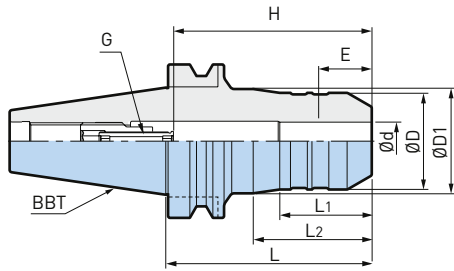

Fig. 8

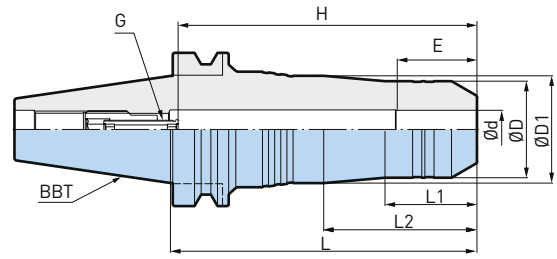

Fig. 9

Model	Order No.	Fig.	Ød	ØD	ØD1	L	L1	L2	H	E	G
BBT50-HDC32L-90	800.021	8	32	72	-	90	47	-	56 - 96	56	HDA20-12047
BBT50-HDC32L-105	800.016	8	32	72	-	105	62	-	71 - 111	56	HDA20-12047
BBT50-HDC32L-135	800.017	8	32	72	78	135	60	78	101 - 141	56	HDA20-12047
BBT50-HDC32L-165	800.018	8	32	72	80	165	60	108	131 - 171	56	HDA20-12047
BBT50-HDC32L-200	800.019	9	32	72	80	200	60	100	166 - 200	56	HDA20-12047
BBT50-HDC32L-250 *	800.020	9	32	72	80	250	60	100	200	56	-
BBT50-HDC42L-110	800.022	8	42	96	-	440	72	-	76 - 116	65	HDA20-12047

1. BIG-PLUS® tools can be used in machining centers with non BIG-PLUS® spindles.
2. Straight collet (reduction sleeve) is available.
3. "E" is the min. clamping length.
4. "G" is the adjusting screw (optional).
5. "H" is the max. tool shank length that can be inserted for these models.
6. * Adjusting screw cannot be used.
7. ** Straight collet can not be used.

Caution

- Use only cutting tools that have a shank tolerance within h6.
- Roughing endmills are not recommended for use with hydraulic chucks.
- Do not use with cutting tools made with a flat on the shank. (ie: Weldon type shank)
- Do not tighten the clamping screw without first inserting a cutting tool into the hydraulic chuck.
- Always insert the cutting tool into the hydraulic chuck beyond min. clamping length E.

Accessories & Spare Parts

<p>PJC Collets</p>  <p>▶ 347</p>	<p>PSC Collets</p>  <p>▶ 348</p>	<p>Adjusting Screws HDA</p>  <p>▶ 354</p>	<p>Wiper Cleaners</p>  <p>▶ 370</p>
---	---	--	--

Hydraulic Chuck E Type

Substantial body design to allow high-feed endmilling, achieving highly reliable machining.

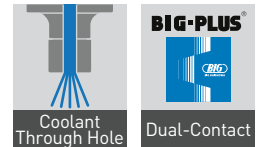

A.1

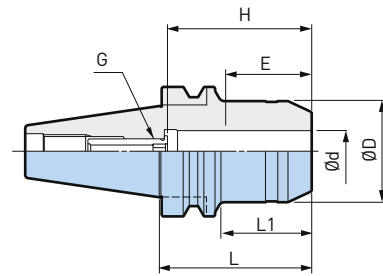

Fig. 1

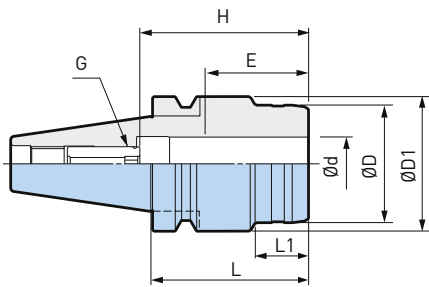

Fig. 2

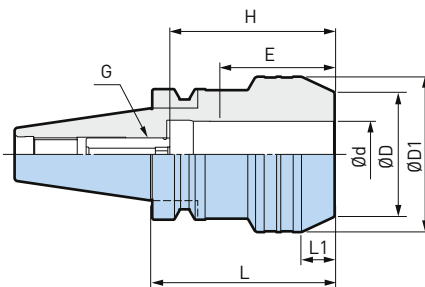

Fig. 3

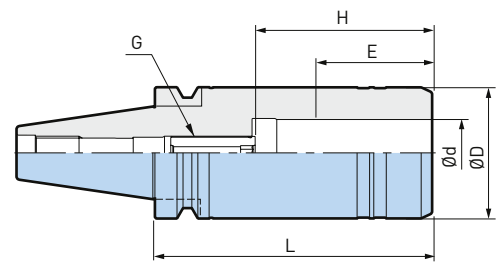

Fig. 4

ø3 - 32mm

Model	Order No.	Fig.	Ød	ØD	ØD1	L	L1	H	E	G
BBT40-HDC20E-75	978.173	1	20	49,2	-	75	45	43 - 70	43	HDA16-12037
BBT40-HDC25E-75	800.120	2	25	55	63	75	25	52 - 80	52	HDA25-16033
BBT40-HDC25E-110	800.117	2	25	55	63	110	25	52 - 80	52	HDA25-16039
BBT40-HDC25E-135	800.118	2	25	55	63	135	25	52 - 80	52	HDA25-16039
BBT40-HDC25E-165	800.119	2	25	55	63	165	25	52 - 80	52	HDA25-16039
BBT40-HDC32E-90	800.124	3	32	60	75	90	16	56 - 80.5	56	HDA25-16039
BBT40-HDC32E-110	800.121	2	32	63	75	110	34	56 - 85	56	HDA25-16039
BBT40-HDC32E-135	800.122	4	32	62,9	-	135	-	56 - 85	56	HDA25-16039
BBT40-HDC32E-165	800.123	4	32	62,9	-	165	-	56 - 85	56	HDA25-16039

- "H" is the max. tool shank length that can be inserted for these models.
- Double sides hexagon screw type can be clamped from chuck and shank side.

Caution

- Use only cutting tools that have a shank tolerance within h6.
- Roughing endmills are not recommended for use with hydraulic chucks.
- Do not use with cutting tools made with a flat on the shank. (ie: Weldon type shank)
- Do not tighten the clamping screw without first inserting a cutting tool into the hydraulic chuck.
- Always insert the cutting tool into the hydraulic chuck beyond min. clamping length E.

Accessories & Spare Parts

<p>PJC Collets</p>  <p>▶ 347</p>	<p>PSC Collets</p>  <p>▶ 348</p>	<p>Adjusting Screws HDA</p>  <p>▶ 354</p>	<p>TK Cleaners</p>  <p>▶ 370</p>
---	---	--	---

Mold Chuck

Slim and tapered design reduces outer diameter and improves stability.
Ideal for machining moulds with weldon tools.

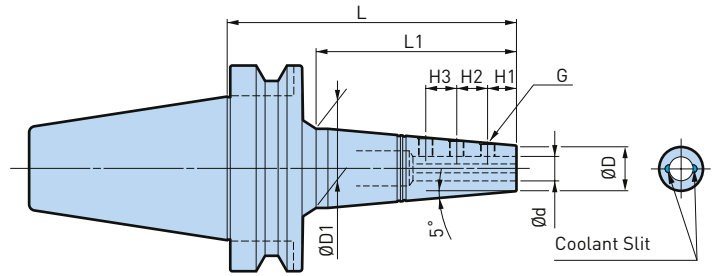
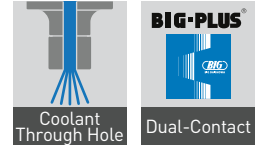

A.1

ø3 - 20mm

Model	Order No.	Ød	ØD	ØD1	L	L1	G	H1	H2	H3
BBT40-SSL3-135	800.172	3	10	27,5	135	100	M3	6	6	-
BBT40-SSL4-135	800.173	4	11	28,5	135	100	M4	6	7	-
BBT40-SSL6-135	966.353	6	13	30	135	100	M6	12	13	-
BBT40-SSL8-135	966.354	8	15	32	135	100	M6	13,5	18	-
BBT40-SSL10-150	800.170	10	17	36,5	150	115	M6	15	20	-
BBT40-SSL12-150	800.171	12	22	41,5	150	115	M8	15	16	16
BBT50-SSL6-150	978.280	6	13	31	150	104	M6	12	13	-
BBT50-SSL6-200	800.363	6	13	39,5	200	154	M6	12	13	-
BBT50-SSL8-150	800.364	8	15	32,5	150	104	M6	13,5	18	-
BBT50-SSL8-200	800.365	8	15	41,5	200	154	M6	13,5	18	-
BBT50-SSL10-150	800.356	10	17	34,5	150	104	M6	15	20	-
BBT50-SSL10-200	800.357	10	17	43,5	200	154	M6	15	20	-
BBT50-SSL12-150	978.281	12	22	39,5	150	104	M8	15	16	16
BBT50-SSL12-200	800.358	12	22	48	200	154	M8	15	16	16
BBT50-SSL16-150	800.359	16	26	43	150	104	M8	15	20	22
BBT50-SSL16-200	800.360	16	26	52	200	154	M8	15	20	22
BBT50-SSL20-150	800.361	20	30	47	150	104	M8	15	20	25
BBT50-SSL20-200	800.362	20	30	56	200	154	M8	15	20	25

1. Only 2 flute ball endmill with weldon shank is to be used.
2. 1 set of exclusive clamping screws are included.

Accessories & Spare Parts

Mold Chuck Clamping Screw



▶ 366

Shrink Chuck Slim

Slim design reduces outer diameter for machining in tight spaces.

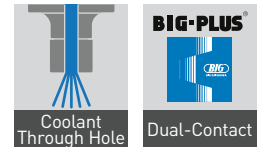

A.1

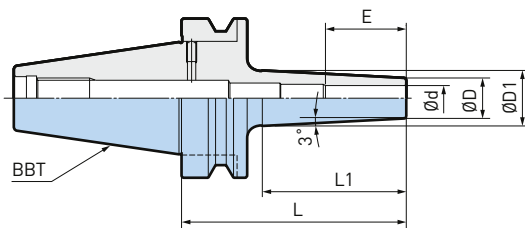

Fig. 1

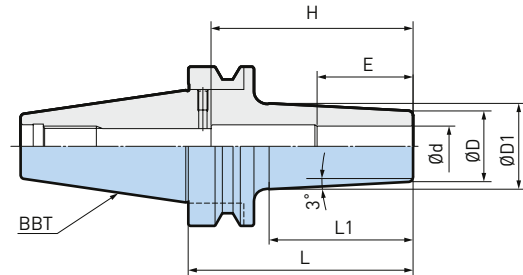

Fig. 2

ø6 - 12mm

Model	Order No.	Fig.	Ød	ØD	ØD1	L	L1	H	E
BBT30-SRC6S-105	978.179	1	6	10	18	105	77	129 *	26
BBT30-SRC8S-105	978.180	1	8	13	21	105	77	129 *	26
BBT30-SRC10S-105	800.063	2	10	16	24	105	77	62	32
BBT30-SRC12S-105	978.007	2	12	19	27	105	77	72	36
BBT40-SRC6S-120	800.168	1	6	10	19	120	86	155 *	26
BBT40-SRC6S-165	978.136	1	6	10	23.5	165	127	200 *	26
BBT40-SRC8S-120	978.205	1	8	13	22	120	86	155 *	26
BBT40-SRC8S-165	978.137	1	8	13	26.5	165	129	200 *	26
BBT40-SRC10S-120	978.367	1	10	16	25	120	86	155 *	32
BBT40-SRC10S-165	978.138	1	10	16	29.5	165	129	200 *	32
BBT40-SRC12S-120	800.163	1	12	19	28	120	87	155 *	36
BBT40-SRC12S-165	978.139	1	12	19	33	165	131	200 *	36

1. BIG-PLUS® tools can be used in machining centers with non BIG-PLUS® spindles.
2. Use carbide cutter within a tolerance of h6.
3. Please refer to the operation manual of heating / cooling equipment, as some equipment may not be compatible.
4. "H" is the max. tool shank length that can be inserted for these models.
5. „H" with * indicates the maximum clamping depth to the Pull Stud Bolt.
6. "E" is the min. clamping length.

Accessories & Spare Parts

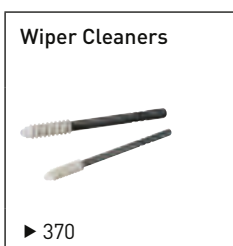

Shrink Chuck Jet Through

Efficient coolant supply to the cutting tool periphery.

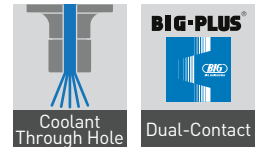

A.1

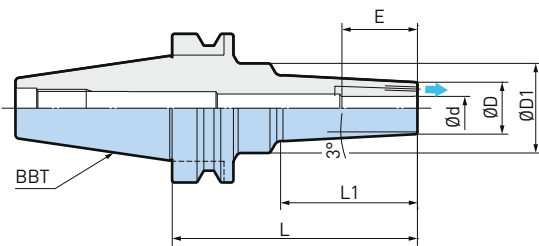

ø6 - 12mm

Model	Order No.	$\varnothing d$	$\varnothing D$	$\varnothing D1$	L	L1	E
BBT40-SRC6J-105	804.751	6	16	32	105	55	26
BBT40-SRC8J-105	804.752	8	19	35	105	55	26
BBT40-SRC10J-105	804.749	10	22	38	105	58	32
BBT40-SRC12J-105	804.750	12	24	40	105	63	36
BBT50-SRC6J-165	804.755	6	16	42	165	93	26
BBT50-SRC8J-165	804.756	8	19	45	165	99	26
BBT50-SRC10J-165	804.753	10	22	48	165	103	32
BBT50-SRC12J-165	804.754	12	24	50	165	108	36

1. BIG-PLUS® tools can be used in machining centers with non BIG-PLUS® spindles.
2. Use carbide cutter within a tolerance of h6.
3. Please refer to the operation manual of heating / cooling equipment, as some equipment may not be compatible.
4. "E" is the min. clamping length.

Accessories & Spare Parts

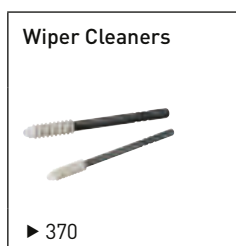

Shrink Chuck Standard

Substantial body provides higher rigidity.

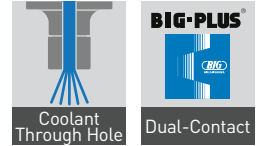

A.1

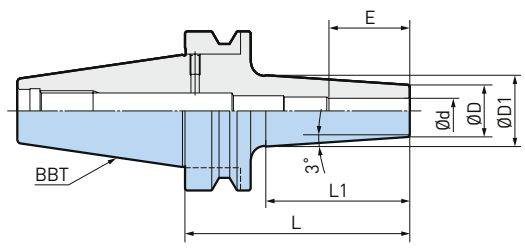

Fig. 1

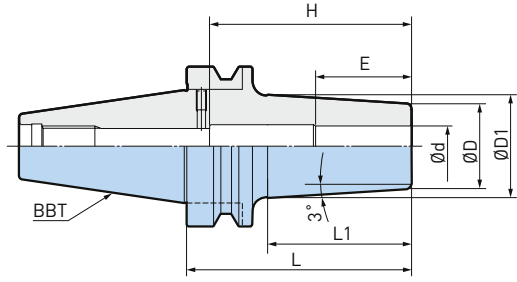

Fig. 2

ø4 - 20mm

Model	Order No.	Fig.	Ød	ØD	ØD1	L	L1	H	E
BBT30-SRC4-75 *	978.001	1	4	10	15	75	44	-	16
BBT30-SRC6-75	978.002	1	6	14	19	75	47	-	26
BBT30-SRC8-75	978.003	1	8	18	23	75	47	-	26
BBT30-SRC10-75	978.004	2	10	22	27	75	47	62	32
BBT30-SRC12-75	978.005	2	12	24	29	75	47	72	36
BBT30-SRC16-75	978.006	2	16	28	33	75	48	80	38
BBT40-SRC4-90 *	978.291	1	4	10	15.5	90	52	-	16
BBT40-SRC6-90	978.056	1	6	14	20	90	57	-	26
BBT40-SRC6-150	800.167	1	6	14	26	150	114	-	26
BBT40-SRC8-90	978.057	1	8	18	24	90	57	-	26
BBT40-SRC8-150	800.169	1	8	18	18	150	114	-	26
BBT40-SRC10-90	978.058	1	10	22	28	90	57	-	32
BBT40-SRC10-150	800.161	1	10	22	34	150	116	-	32
BBT40-SRC12-90	978.059	1	12	24	30	90	57	-	36
BBT40-SRC12-150	800.162	1	12	24	36	150	116	-	36
BBT40-SRC16-90	978.060	2	16	28	34	90	57	80	38
BBT40-SRC16-165	800.164	2	16	28	42	165	132	80	38
BBT40-SRC20-90	978.061	2	20	34	40	90	57	100	42
BBT40-SRC20-165	800.165	2	20	34	48	165	132	100	42
BBT50-SRC6-105	978.105	1	6	14	20.5	105	61	-	26
BBT50-SRC6-165	800.354	1	6	14	26	165	116	-	26
BBT50-SRC8-105	978.107	1	8	18	24.5	105	61	-	26
BBT50-SRC8-165	800.355	1	8	18	30	165	116	-	26
BBT50-SRC10-105	978.109	1	10	22	28.5	105	61	-	32
BBT50-SRC10-165	800.350	1	10	22	34	165	116	-	32
BBT50-SRC12-105	978.111	1	12	24	30.5	105	61	-	36
BBT50-SRC12-165	800.351	1	12	24	36	165	116	-	36
BBT50-SRC16-105	978.113	1	16	28	34.5	105	61	-	38
BBT50-SRC16-165	978.114	1	16	28	40	165	116	-	38
BBT50-SRC20-105	978.115	1	20	34	40	105	61	-	42
BBT50-SRC20-165	800.352	1	20	34	46	165	116	-	42

1. BIG-PLUS® tools can be used in machining centers with non BIG-PLUS® spindles.
2. Use carbide cutter within a tolerance of h6.
3. * Use carbide cutter within a tolerance of h5.
4. Please refer to the operation manual of heating / cooling equipment, as some equipment may not be compatible.
5. "H" is the max. tool shank length that can be inserted for these models.
6. "E" is the min. clamping length.

CK Shanks with Center Through Coolant

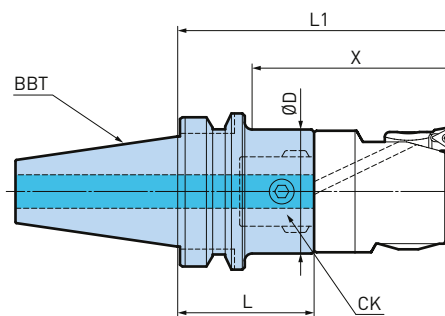
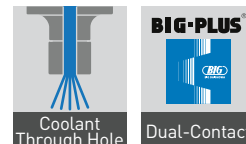

A.1

CK1 - CK7

Model	Order No.	CK	ØD	L	L1	X
BBT30-CKB1-72	328.308	CKB1	19	72	104	73
BBT30-CKB2-83	328.260	CKB2	24	82.5	118	93
BBT30-CKB3-39	328.272	CKB3	31	39	79	53
BBT30-CKB4-73	328.261	CKB4	39	73	120	93
BBT30-CKB5-63	328.262	CKB5	50	63	120	93
BBT30-CKB6-64	328.289	CKB6	64	64	64	42
BBT40-CKB1-72	869.017	CKB1	19	72	104	73
BBT40-CKB2-43	807.184	CKB2	24	42.5	78	48
BBT40-CKB2-83	806.680	CKB2	24	82.5	118	88
BBT40-CKB3-44	807.150	CKB3	31	44	84	53
BBT40-CKB3-124	806.681	CKB3	31	124	164	133
BBT40-CKB4-43	806.328	CKB4	39	43	90	58
BBT40-CKB4-118	806.284	CKB4	39	118	165	133
BBT40-CKB5-48	806.902	CKB5	50	48	105	73
BBT40-CKB5-108	806.682	CKB5	50	108	165	133
BBT40-CKN6-46	323.832N	CKN6	63.5	46	117	85
BBT40-CKN6-61	323.831N	CKN6	63.5	61	132	100
BBT40-CKB6-64	806.924	CKB6	64	64	132	32
BBT40-CKB6-94	869.008	CKB6	64	94	165	133

continues on the next page

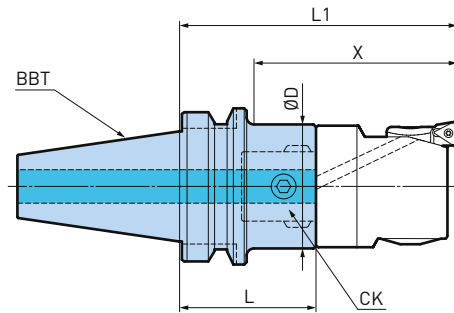

Model	Order No.	CK	ØD	L	L1	X
BBT50-CKB1-102	869.002	CKB1	19	102	134	73
BBT50-CKB2-53	869.003	CKB2	24	53	88	47
BBT50-CKB2-113	869.011	CKB2	24	112.5	148	107
BBT50-CKB3-54	869.004	CKB3	31	54	94	52
BBT50-CKB3-124	806.683	CKB3	31	124	164	122
BBT50-CKB4-58	869.005	CKB3	31	124	164	122
BBT50-CKB4-118	869.013	CKB3	31	124	164	122
BBT50-CKB4-178	869.015	CKB4	39	178	225	182
BBT50-CKB4-208	869.012	CKB4	39	208	255	212
BBT50-CKB5-63	869.001	CKB5	50	63	120	77
BBT50-CKB5-108	869.014	CKB5	50	108	165	122
BBT50-CKB5-183	806.684	CKB5	50	183	240	197
BBT50-CKB5-228	807.071	CKB5	50	228	285	242
BBT50-CKB5-263	806.685	CKB5	50	263	320	277
BBT50-CKN6-72	323.874N	CKN6	63.5	72	143	100
BBT50-CKB6-94	869.007	CKB6	64	94	165	122
BBT50-CKB6-169	807.183	CKB6	64	169	240	197
BBT50-CKB6-229	806.686	CKB6	64	229	300	257
BBT50-CKB6-289	806.687	CKB6	64	289	360	317
BBT50-CKN7-86	323.871N	CKN7	90	86	203 (173)	160 (130)
BBT50-CKB7-136	323.875	CKB7	90	136	253 (223)	210 (180)
BBT50-CKB7-183	806.688	CKB7	90	183	300 (270)	257 (227)
BBT50-CKB7-243	806.689	CKB7	90	243	360 (330)	317 (287)

1. BIG-PLUS® tools can be used in machining centers with non BIG-PLUS® spindles.
2. X and L1 dimensions on the table are reference figures when EWN/EWE head is mounted.
3. Cutting edge and drive key grooves are located in the same orientation.
4. () Indicate the length when short version of EWN (EWN100-203CKB7-87) is mounted.

Accessories & Spare Parts

Fine Boring Heads



► 396-399

Extra Long CK Shanks with Center Through Coolant

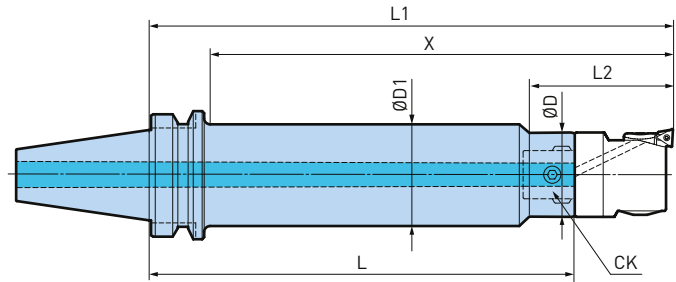
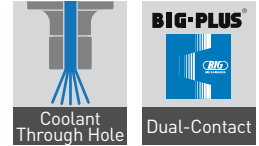

A.1

CK4 - CK6

Model	Order No.	CK	ØD	ØD1	L	L1	L2	X
BBT50-CKB4-48-193	806.690	CKB4	39	48	193	240	65	197
BBT50-CKB4-48-238	806.692	CKB4	39	48	238	285	65	242
BBT50-CKB5-62-243	806.693	CKB5	50	62	243	300	80	257
BBT50-CKB5-62-303	806.694	CKB5	50	62	303	360	80	317
BBT50-CKB6-72-259	806.695	CKB6	64	72	259	330	100	287
BBT50-CKB6-72-314	869.018	CKB6	64	72	314	385	100	342
BBT50-CKB6-80-289	806.696	CKB6	64	80	289	360	100	317
BBT50-CKB6-80-349	806.697	CKB6	64	80	349	420	100	377

1. BIG-PLUS® tools can be used in machining centers with non BIG-PLUS® spindles.
2. L1, L2 and X dimensions on the table are reference figures when EWN/EWE head is mounted.
3. Cutting edge and drive key grooves are located in the same orientation.

Accessories & Spare Parts

Fine Boring Heads



▶ 396-399

Smart Damper CK Shanks

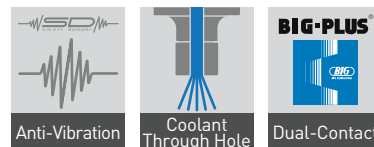

A.1

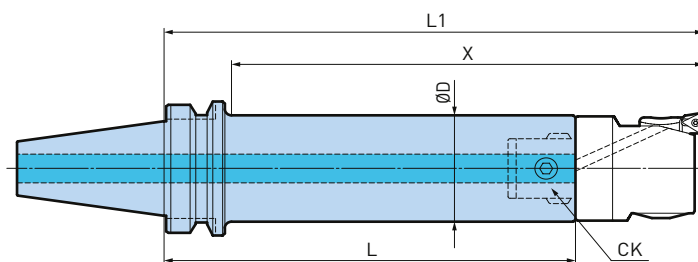

CK4 - CK6

Model	Order No.	CK	ØD	L	L1	X
BBT50-CKB4DP-252	807.547	CKB4	39	252	299	246
BBT50-CKB5DP-314	328.228	CKB5	50	314	371	318
BBT50-CKB6DP-380	328.230	CKB6	64	380	451	408

1. BIG-PLUS® tools can be used in machining centers with non BIG-PLUS® spindles.
2. X and L1 dimensions on the table are reference figures when EWN/EWE head is mounted.
3. Cutting edge and drive key grooves are located in the same orientation.

Accessories & Spare Parts

Fine Boring Heads



► 396-399

CK Shanks with Center Through Coolant

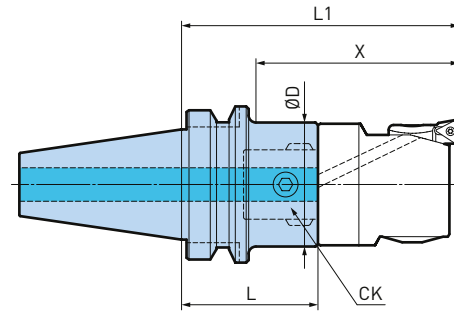

A.1

CK1, CK5, CK6, CK7

Model	Order No.	CK	ØD	L	L1	X
BT30-CKB1-35	323.707	CKB1	19	34.5	67	40
BT30-CKB5-38	329.866	CKB5	50	38	95	68
BT40-CKB6-46	326.160	CKB6	63.5	46	117	85
BT40-CKB6-61	323.731	CKB6	63.5	61	132	100
BT50-CKB6-72	323.770	CKB6	63.5	72	143	100
BT50-CKB7-86	323.771	CKB7	90	86	203 (173)	160 (130)

1. X and L1 dimensions on the table are reference figures when EWN/EWE head is mounted.
2. Cutting edge and drive key grooves are located in the same orientation.
3. () Indicate the length when short version of EWN (EWN100-203CKB7-87) is mounted.

CK Shanks with Center and Flange Through Coolant

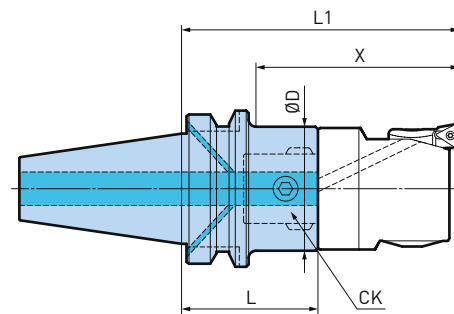

CK3 - CK7

Model	Order No.	CK	ØD	L	L1	X
BT30-CKB3-34ADF	323.705	CKB3	31	34	74	47
BT40-CKB3-42ADF	323.738	CKB3	31	42	82	50
BT40-CKB4-65ADF	326.141	CKB4	39	65	112	80
BT40-CKB5-55ADF	323.730	CKB5	50	55	112	80
BT40-CKB5-105ADF	326.153	CKB5	50	105	162	130
BT40-CKN6-46ADF	323.735N	CKN6	63.5	46	117	85
BT40-CKN6-61ADF	323.736N	CKN6	63.5	61	132	100
BT40-CKB6-91ADF	326.163	CKB6	63.5	91	162	130
BT50-CKN6-72ADF	323.775N	CKN6	63.5	72	143	100
BT50-CKB6-132ADF	323.777	CKB6	63.5	132	203	160
BT50-CKN7-86ADF	323.776N	CKN7	90	86	203 (173)	160 (130)

1. X and L1 dimensions on the table are reference figures when EWN/EWE head is mounted.
2. Cutting edge and drive key grooves are located in the same orientation.
3. ADF indicates both flange through and center through coolant available.
4. () Indicate the length when short version of EWN (EWN100-203CKB7-87) is mounted.

Accessories & Spare Parts

Fine Boring Heads

► 396-399

Face Mill Arbors Type FMH

Coolant ports on the face.

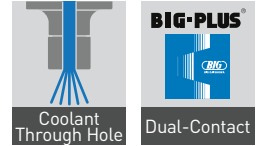

A.1

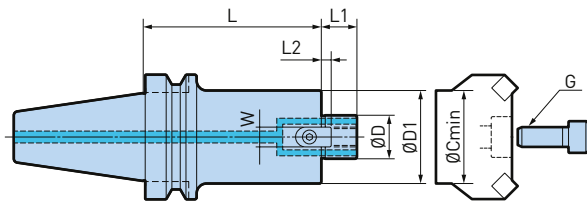
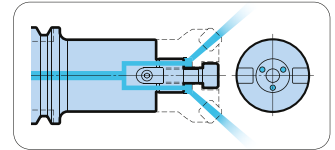

Fig. 1

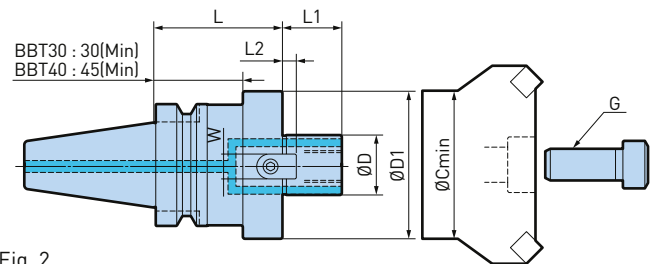

Fig. 2

Model	Order No.	Fig.	ØD	ØD1	L	L1	L2	W	G	ØC min.
BBT30-FMH16-37-35	978.326	1	16	37	35	16	5	8	M8	28
BBT30-FMH22-47-45	978.259	2	22	47	45	18	5	10	M10	38
BBT30-FMH22-60-45	805.569	2	22	60	45	18	5	10	M10	38
BBT30-FMH27-60-45	978.273	2	27	60	45	20	6	12	M12	46
BBT40-FMH16-37-40	800.066	1	16	37	40	16	5	8	M8	28
BBT40-FMH22-47-45	978.145	1	22	47	45	18	5	10	M10	38
BBT40-FMH22-47-60	978.324	1	22	47	60	18	5	10	M10	36
BBT40-FMH22-47-90	800.074	1	22	47	90	18	5	10	M10	36
BBT40-FMH22-47-150	978.378	1	22	47	150	18	5	10	M10	36
BBT40-FMH22-60-45	978.368	1	22	60	45	18	5	10	M10	38
BBT40-FMH22-60-60	800.075	1	22	60	60	18	5	10	M10	38
BBT40-FMH22-60-90	978.208	1	22	60	90	18	5	10	M10	38
BBT40-FMH27-60-45	978.219	1	27	60	45	20	6	12	M12	46
BBT40-FMH27-60-60	800.079	1	27	60	60	20	6	12	M12	46
BBT40-FMH27-60-90	978.128	1	27	60	90	20	6	12	M12	46
BBT40-FMH27-76-60	800.080	2	27	76	60	20	6	12	M12	48
BBT40-FMH27-76-90	800.081	2	27	76	90	20	6	12	M12	48
BBT40-FMH32-96-60	978.035	2	32	96	60	22	7	14	M16	58

Model	Order No.	Fig.	ØD	ØD1	L	L1	L2	W	G	ØC min.
BBT50-FMH16-37-60	800.207	1	16	37	60	16	5	8	M8	28
BBT50-FMH16-37-105	800.204	1	16	37	105	16	5	8	M8	28
BBT50-FMH16-37-150	800.205	1	16	37	150	16	5	8	M8	28
BBT50-FMH16-37-200	800.206	1	16	37	200	16	5	8	M8	28
BBT50-FMH22-47-60	978.129	1	22	47	60	18	5	10	M10	38
BBT50-FMH22-47-105	978.130	1	22	47	105	18	5	10	M10	36
BBT50-FMH22-47-150	978.131	1	22	47	150	18	5	10	M10	36
BBT50-FMH22-47-200	978.148	1	22	47	200	18	5	10	M10	36
BBT50-FMH22-47-250	800.221	1	22	47	250	18	5	10	M10	36
BBT50-FMH22-47-300	800.222	1	22	47	300	18	5	10	M10	36
BBT50-FMH22-47-350	800.223	1	22	47	350	18	5	10	M10	36
BBT50-FMH22-60-60	978.403	1	22	60	60	18	5	10	M10	38
BBT50-FMH22-60-105	978.167	1	22	60	105	18	5	10	M10	38
BBT50-FMH22-60-150	800.224	1	22	60	150	18	5	10	M10	38
BBT50-FMH22-60-200	800.225	1	22	60	200	18	5	10	M10	38
BBT50-FMH22-60-250	978.141	1	22	60	250	18	5	10	M10	38
BBT50-FMH22-60-300	800.226	1	22	60	250	18	5	10	M10	38
BBT50-FMH22-60-350	800.227	1	22	60	350	18	5	10	M10	38
BBT50-FMH27-60-45	800.237	1	27	60	45	20	6	12	M12	46
BBT50-FMH27-60-90	978.174	1	27	60	90	20	6	12	M12	46
BBT50-FMH27-60-150	978.175	1	27	60	150	20	6	12	M12	46
BBT50-FMH27-60-200	800.235	1	27	60	200	20	6	12	M12	46
BBT50-FMH27-60-250	978.029	1	27	60	250	20	6	12	M12	46
BBT50-FMH27-60-300	800.236	1	27	60	300	20	6	12	M12	46
BBT50-FMH27-76-45	978.341	1	27	76	45	20	6	12	M12	48
BBT50-FMH27-76-90	978.168	1	27	76	90	20	6	12	M12	48
BBT50-FMH27-76-150	978.142	1	27	76	150	20	6	12	M12	48
BBT50-FMH27-76-200	800.238	1	27	76	200	20	6	12	M12	48
BBT50-FMH27-76-250	800.239	1	27	76	250	20	6	12	M12	48
BBT50-FMH27-76-300	800.240	1	27	76	240	20	6	12	M12	48
BBT50-FMH32-96-45	978.132	1	32	96	45	22	7	14	M16	58
BBT50-FMH32-96-90	978.133	1	32	96	90	22	7	14	M16	58
BBT50-FMH32-96-150	978.143	1	32	96	150	22	7	14	M16	58
BBT50-FMH32-96-200	978.183	1	32	96	200	22	7	14	M16	58
BBT50-FMH32-96-300	800.256	1	32	96	300	22	7	14	M16	80
BBT50-FMH40-100-45	978.149	1	40	100	45	26	8.5	16	M20 (MBA-M20H)	70
BBT50-FMH40-100-75	961.371	1	40	100	75	26	8.5	16	M20(MBA-M20H)	70
BBT50-FMH40-100-105	961.372	1	40	100	105	26	8.5	16	M20(MBA-M20H)	70

1. BIG-PLUS® tools can be used in machining centers with non BIG-PLUS® spindles.
2. Clamp bolt is included.
3. By using a clamping screw with a through bore, coolant is supplied through the screw

Accessories & Spare Parts

Clamp Bolts



► 355

Smart Damper Basic Holders for Milling Heads

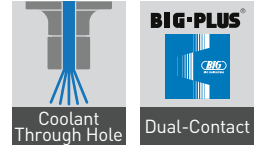

A.1

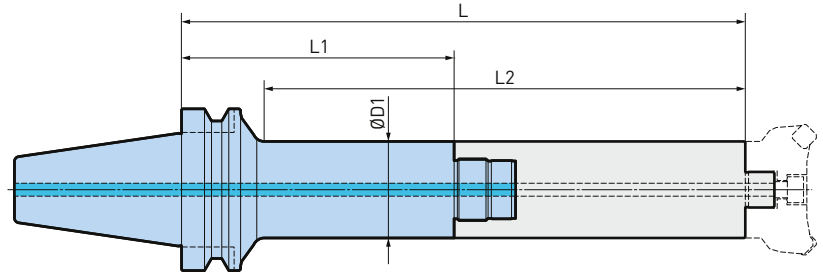

Model	Order No.	ØD1	L	L1	L2	Damper Head Model
BBT50-SDF36-47-70	806.579	47	250	70	197	FMH_DP-47
BBT50-SDF36-47-120	806.580	47	300	120	247	FMH_DP-47
BBT50-SDF36-47-170	804.975	47	350	170	297	FMH_DP-47
BBT50-SDF36-47-220	804.970	47	400	220	347	FMH_DP-47
BBT50-SDF36-60-70	806.581	60	250	70	197	FMH_DP-60
BBT50-SDF36-60-120	806.582	60	300	120	247	FMH_DP-60
BBT50-SDF36-60-170	804.973	60	350	170	297	FMH_DP-60
BBT50-SDF36-60-220	804.974	60	400	220	347	FMH_DP-60
BBT50-SDF57-76-70	807.674	76	250	70	207	FMH_DP-76
BBT50-SDF57-76-120	807.675	76	300	120	257	FMH_DP-76
BBT50-SDF57-76-170	807.676	76	350	170	307	FMH_DP-76
BBT50-SDF57-76-220	807.677	76	400	220	357	FMH_DP-76

1. BIG-PLUS® tools can be used in machining centers with non BIG-PLUS® spindles.

Combinations

Basic Holder

Damper Head

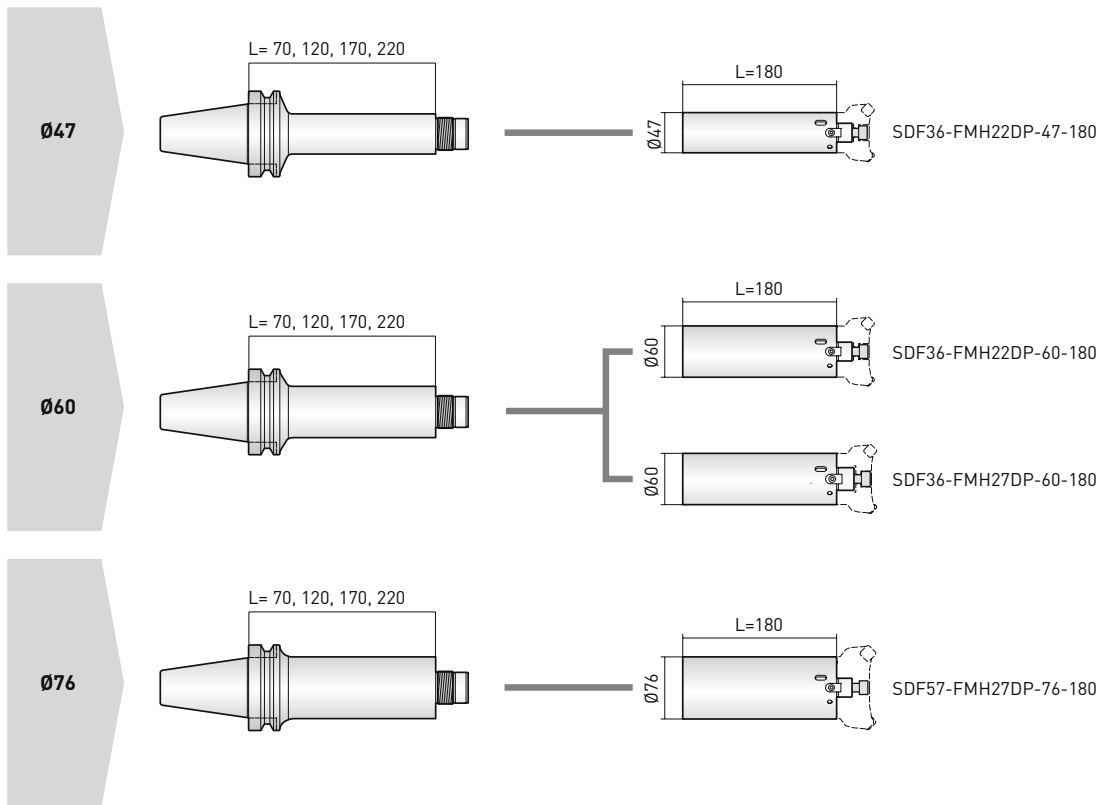

Smart Damper Damper Heads for Mills

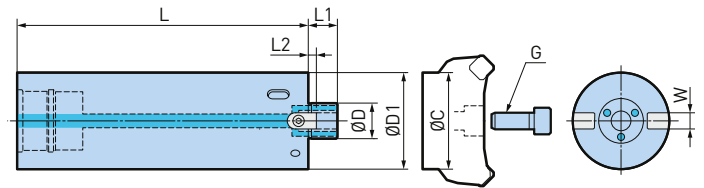
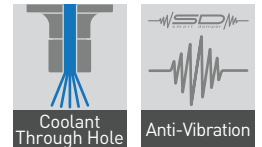

A.1

Model	Order No.	ØD	ØD1	L	L1	L2	G	W	ØC min.
SDF36-FMH22DP-47-180	804.969	22	47	180	18	5	M10	10	36
SDF36-FMH22DP-60-180	804.971	22	60	180	18	5	M10	10	38
SDF36-FMH27DP-60-180	804.972	27	60	180	20	6	M12	12	46
SDF57-FMH27DP-76-180	807.673	27	76	180	20	6	M12	12	48

1. Wrench and cutter clamping bolt are included.
2. By using a clamping screw with a through bore, coolant is supplied through the screw

Accessories & Spare Parts

<p>FK Wrenches</p>  <p>▶ 352</p>	<p>Clamp Bolts</p>  <p>▶ 355</p>
---	---

Super Keyless Chuck

Securely chucks the drill with simple operation.



A.1



Reverse lock mechanism (SKL13)

- No loosening even when the main spindle suddenly stops, by the reverse lock mechanism using a lock ring.
- Runout accuracy within 0.05mm

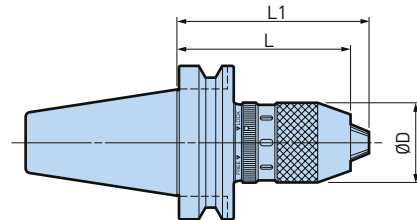
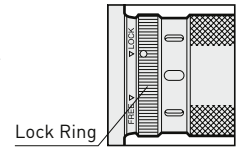

Model	Order No.	Ød	ØD	L	L1	Wrench
BBT30-KLC6.5-70	805.444	0,5 - 6,5	34	70	76,5	FS6.5LC
BBT30-SKL13-110	802.336	0,5 - 13	51	110	122,5	FS13LC
BBT40-KLC6.5-75	805.531	0,5 - 6,5	34	75	81,5	FS6.5LC
BBT40-SKL13-105	805.168	0,5 - 13	51	106	118,5	FS13LC
BBT50-SKL13-115	805.170	0,5 - 13	51	115	127,5	FS13LC

1. Wrench is included.
2. KLC type does not have the reverse lock mechanism.

Accessories & Spare Parts

Hook wrench for Super Keyless Chuck (FS)



▶ 355

Side Lock Holders Type TSL

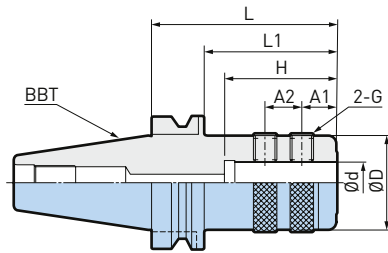
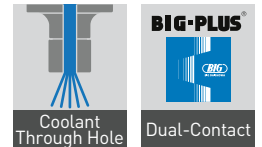

Fig. 1

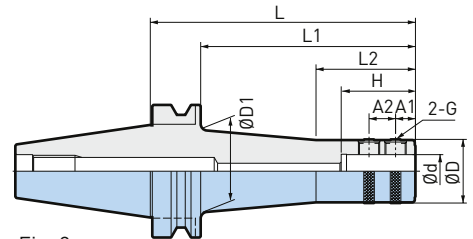

Fig. 2

A.1

ø16 - 50mm

Model	Order No.	Fig.	Ød	ØD	L	L1	L2	H	A1	A2	G
BBT30-TSL16-75	800.064	1	16	48	75	-	-	48	14	14	M10
BBT30-TSL20-75	978.314	1	20	48	75	-	-	50	14	14	M10
BBT30-TSL25-80	978.315	1	25	48	80	-	-	56	15	20	M16
BBT30-TSL32-85	805.243	1	32	63	85	-	-	60	15	20	M16
BBT40-TSL16-90	800.175	1	16	48	90	63	-	48	14	14	M10
BBT40-TSL16-105	800.174	1	16	48	105	78	-	48	14	14	M10
BBT40-TSL20-90	800.177	1	20	48	90	63	-	50	14	14	M10
BBT40-TSL20-105	800.176	1	20	48	105	78	-	50	14	14	M10
BBT40-TSL25-90	800.179	1	25	48	90	63	-	56	15	20	M16
BBT40-TSL25-105	800.178	1	25	48	105	78	-	56	15	20	M16
BBT40-TSL32-105	978.318	1	32	63	105	78	-	60	15	20	M16
BBT40-TSL32-135	800.180	1	32	63	135	108	-	60	15	20	M16
BBT40-TSL40-105	978.317	1	40	68	105	-	-	70	15	25	M16
BBT50-TSL16-90	800.369	1	16	48	90	52	-	48	14	14	M10
BBT50-TSL16-135	800.366	1	16	48	135	97	-	48	14	14	M10
BBT50-TSL16-165	800.367	1	16	48	165	127	-	48	14	14	M10
BBT50-TSL16-200	800.368	2	16	48	200	162	75	48	14	14	M10
BBT50-TSL20-90	800.374	1	20	48	90	52	-	50	14	14	M10
BBT50-TSL20-135	800.370	1	20	48	135	97	-	50	14	14	M10
BBT50-TSL20-165	800.371	1	20	48	165	127	-	50	14	14	M10
BBT50-TSL20-200	800.372	2	20	48	200	162	75	50	14	14	M10
BBT50-TSL20-250	800.373	2	20	48	250	212	90	50	14	14	M10
BBT50-TSL25-105	800.375	1	25	48	105	67	-	56	15	20	M16
BBT50-TSL25-135	800.376	1	25	48	135	97	-	56	15	20	M16
BBT50-TSL25-165	800.377	1	25	48	165	127	-	56	15	20	M16
BBT50-TSL25-200	800.378	2	25	48	200	162	75	56	15	20	M16
BBT50-TSL25-250	800.379	2	25	48	250	212	90	56	15	20	M16
BBT50-TSL32-105	800.380	1	32	63	105	67	-	60	15	20	M16
BBT50-TSL32-135	800.381	1	32	63	135	97	-	60	15	20	M16
BBT50-TSL32-165	800.382	1	32	63	165	127	-	60	15	20	M16
BBT50-TSL32-200	800.383	1	32	63	200	162	-	60	15	20	M16
BBT50-TSL32-250	800.384	1	32	63	250	212	-	60	15	20	M16
BBT50-TSL40-105	800.385	1	40	68	105	67	-	70	15	25	M16
BBT50-TSL40-135	800.386	1	40	68	135	97	-	70	15	25	M16
BBT50-TSL40-165	800.387	1	40	68	165	127	-	70	15	25	M16
BBT50-TSL40-200	800.388	1	40	68	200	162	-	70	15	25	M16
BBT50-TSL40-250	800.389	1	40	68	250	212	-	70	15	25	M16
BBT50-TSL50-105	800.390	1	50	84	105	67	-	70	15	25	M16
BBT50-TSL50-150	800.391	1	50	84	150	112	-	70	15	25	M16

Accessories & Spare Parts

Sleeves for TSL & OSL



▶ 355

1. BIG-PLUS® tools can be used in machining centers with non BIG-PLUS® spindles.
2. "H" is the max. tool shank length that can be inserted for these models.
3. Not compatible with Weldon DIN 1835 B / DIN 6535 HB.

Side Lock Holders for Weldon

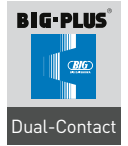

A.1

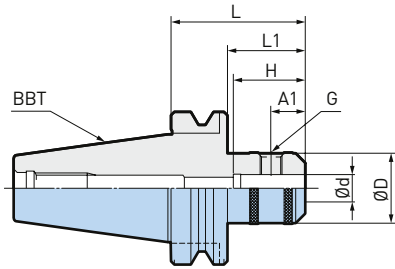

Fig. 1

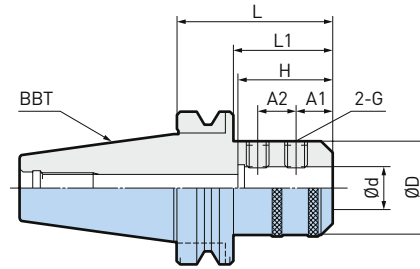

Fig. 2

ø6 - 50mm

Model	Order No.	Fig.	Ød	ØD	L	L1	A1	A2	H	G
BBT30-ISL6-60	961.394	1	6	25	60	38	18	-	85 *	M6
BBT30-ISL8-60	961.395	1	8	28	60	38	18	-	85 *	M8
BBT30-ISL10-60	961.396	1	10	35	60	38	20	-	45	M10
BBT30-ISL12-60	961.397	1	12	42	60	38	22.5	-	48	M12
BBT30-ISL16-60	966.341	1	16	48	60	38	24	-	53	M14
BBT40-ISL6-75	807.200	1	6	25	75	48	18	-	110 *	M6
BBT40-ISL8-75	807.201	1	8	28	75	48	18	-	110 *	M8
BBT40-ISL10-75	807.202	1	10	35	75	48	20	-	110 *	M10
BBT40-ISL12-75	961.362	1	12	42	75	48	22.5	-	110 *	M12
BBT40-ISL16-75	961.363	1	16	48	75	48	24	-	53	M14
BBT40-ISL20-75	961.364	1	20	52	75	48	25	-	55	M16
BBT40-ISL25-90	961.365	2	25	63.5	90	63	24	25	60	M18 P2
BBT40-ISL32-105	961.366	2	32	72	105	-	24	28	82	M20 P2
BBT50-ISL16-90	961.367	1	16	48	90	52	24	-	145 *	M14
BBT50-ISL16-150	800.297	2	16	48	150	60	24	-	205 *	M14
BBT50-ISL20-90	961.368	1	20	52	90	52	25	-	145 *	M16
BBT50-ISL20-150	800.299	2	20	52	150	60	25	-	60	M16
BBT50-ISL25-105	961.369	2	25	65	105	67	24	25	60	M18 P2
BBT50-ISL25-150	800.301	2	25	65	150	107	24	25	60	M18 P2
BBT50-ISL32-105	978.017	2	32	72	105	67	24	28	90	M20 P2
BBT50-ISL32-150	800.303	2	32	72	150	107	24	28	90	M20 P2
BBT50-ISL40-120	978.018	2	40	90	120	82	30	32	90	M20 P2
BBT50-ISL40-150	800.305	2	40	90	150	109	30	32	90	M20 P2
BBT50-ISL42-120	800.307	2	42	90	120	79	30	32	90	M20 P2
BBT50-ISL42-150	800.308	2	42	99.5	150	109	30	32	90	M20 P2
BBT50-ISL50-121	978.294	2	50	99.5	121	83	35	35	90	M24 P2

1. BIG-PLUS® tools can be used in machining centers with non BIG-PLUS® spindles.
2. Use a cutting tool in accordance to DIN 1835 B/DIN 6535 HB.
3. "H" is the max. tool shank length that can be inserted for these models.
4. H with * indicates the maximum clamping depth to the Pull Stud Bolt.

HOLDERS FOR SCREW-ON CUTTER

General metric screw-on type cutting tools can be used with these models.

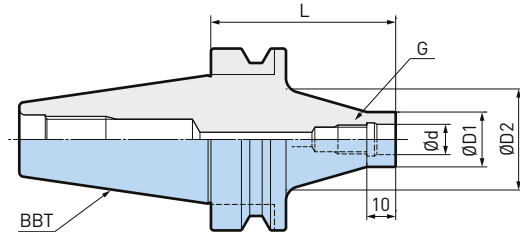
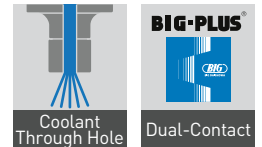

A.1

Model	Order No.	Ød	ØD1	ØD2	L	G
BBT30-M8-15-50	100019.003.0	8.5	15	30	50	M8
BBT30-M10-19-45	806.601	10.5	19	35	45	M10
BBT30-M12-24-40	806.602	12.5	24	40	40	M12
BBT30-M16-29-35	806.603	17	29	40	35	M16
BBT40-M8-15-70	100019.001.0	8.5	15	30	70	M8
BBT40-M8-15-115	100019.002.0	8.5	15	32	115	M8
BBT40-M10-19-65	806.604	10.5	19	35	65	M10
BBT40-M10-19-110	807.361	10.5	19	35	110	M10
BBT40-M12-24-60	806.605	12.5	24	40	60	M12
BBT40-M12-24-105	807.362	12.5	24	40	105	M12
BBT40-M16-29-55	806.606	17	29	45	55	M16
BBT40-M16-29-100	807.363	17	29	45	100	M16

1. BIG-PLUS® tools can be used in machining centers with non BIG-PLUS® spindles.

SIDE CUTTER ARBORS

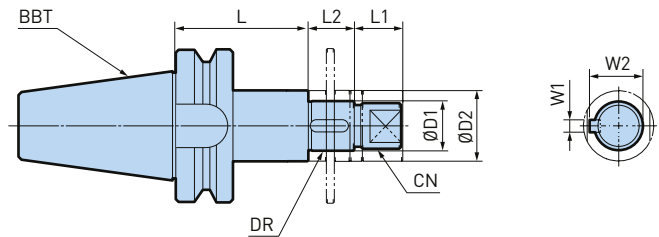
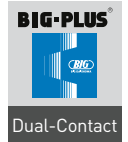

Model	Order No.	ØD1	ØD2	L	L1	L2	W1	W2
BBT40-SCA25.4-75	804.760	25.4	40	75	25	30	6.35	27.78
BBT40-SCA25.4-120	804.762	25.4	40	120	25	30	6.35	27.78
BBT40-SCA31.75-75	804.761	31.75	46	75	30	30	7.92	34.92
BBT50-SCA25.4-90	804.757	25.4	40	90	25	30	6.35	27.78
BBT50-SCA25.4-135	804.763	25.4	40	135	25	30	6.35	27.78
BBT50-SCA31.75-90	804.758	31.75	46	90	30	30	7.92	34.92
BBT50-SCA31.75-135	804.764	31.75	46	135	30	30	7.92	34.92
BBT50-SCA38.1-90	804.759	38.1	55	90	36	30	9.52	42.06
BBT50-SCA38.1-135	804.765	38.1	55	135	36	30	9.52	42.06

- 1. BIG-PLUS® tools can be used in machining centers with non BIG-PLUS® spindles.
- 2. Nut (CN) is included.
- 3. Distance collars (DR) of 5 mm, 8 mm, 10 mm and 12 mm are included.



Morse Taper Holders

Precise finish of inner taper guarantees high concentricity.

A.1

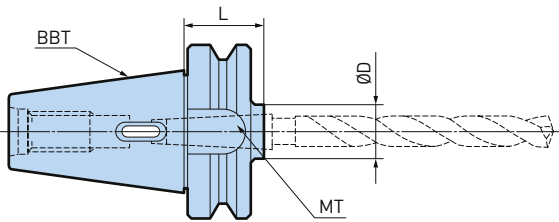

Fig. 1

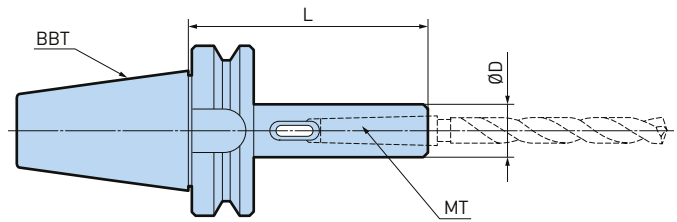
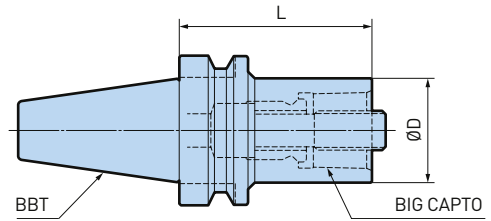
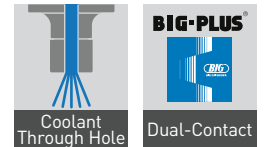

Fig. 2

Model	Order No.	Fig.	MT No.	ØD	L
BBT30-MTA1-60	978.274	1	1	25	60
BBT30-MTA2-60	978.254	1	2	32	60
BBT30-MTA3-80	978.255	1	3	40	80
BBT40-MTA1-45	978.399	1	1	25	45
BBT40-MTA1-120	800.158	2	1	25	120
BBT40-MTA2-45	978.164	1	2	32	45
BBT40-MTA2-120	800.159	2	2	32	120
BBT40-MTA3-75	978.400	1	3	40	75
BBT40-MTA3-135	800.160	2	3	40	135
BBT40-MTA4-90	978.165	2	4	50	90
BBT50-MTA1-45	800.329	1	1	25	45
BBT50-MTA1-120	800.325	2	1	25	120
BBT50-MTA1-210	800.327	2	1	25	210
BBT50-MTA2-45	800.335	1	2	32	45
BBT50-MTA2-135	800.330	2	2	32	135
BBT50-MTA2-210	800.332	2	2	32	210
BBT50-MTA3-45	800.341	1	3	40	45
BBT50-MTA3-75	800.342	2	3	40	75
BBT50-MTA3-150	800.336	2	3	40	150
BBT50-MTA3-210	800.338	2	3	40	210
BBT50-MTA4-75	800.347	1	4	50	75
BBT50-MTA4-180	800.343	2	4	50	180
BBT50-MTA4-250	800.345	2	4	50	250
BBT50-MTA5-105	800.348	2	5	65	105
BBT50-MTA5-210	800.349	2	5	65	210

1. BIG-PLUS® tools can be used in machining centers with non BIG-PLUS® spindles.

BIG CAPTO Basic Holders



A.1

Model	Order No.	BIG CAPTO	ØD	L
BBT40-C3-30	973.598	C3	32	30
BBT40-C4-40	802.350	C4	40	40
BBT40-C5-50	973.600	C5	50	50
BBT40-C6-75	973.601	C6	63	75
BBT50-C3-40	973.602	C3	32	40
BBT50-C4-40	973.603	C4	40	40
BBT50-C5-40	973.604	C5	50	40
BBT50-C6-50	973.605	C6	63	50
BBT50-C8-70	803.736	C8	80	70

1. BIG-PLUS® tools can be used in machining centers with non BIG-PLUS® spindles.
2. Clamp bolt is included.

MEGA Synchro Tapping Holder

Compensates for synchronization errors during rigid tapping. Improves thread quality and tool life by reducing thrust loads caused by synchronization errors up to 90%.

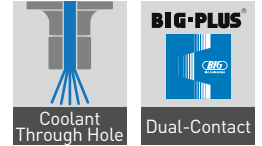

A.1

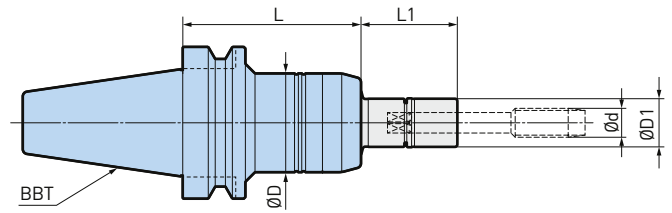

M3 - M20

Model	Order No.	Tap Holder	Ød	ØD	ØD1	L	L1
BBT30-MGT6-70	965.401	MGT6	M3-M8	36	16	70	30 - 200
BBT30-MGT12-70	965.402	MGT12	M5-M12 / P1/8	41	20	70	30 - 200
BBT30-MGT20-110	965.403	MGT20	M10-M20 / P1/4-P1/2	54	30	110	35 - 150
BBT40-MGT6-75	965.404	MGT6	M3-M8	36	16	75	30 - 200
BBT40-MGT12-75	965.405	MGT12	M5-M12 / P1/8	41	20	75	30 - 200
BBT40-MGT20-95	965.406	MGT20	M10-M20 / P1/4-P1/2	54	30	95	35 - 150
BBT50-MGT6-90	965.407	MGT6	M3-M8	36	16	90	30 - 200
BBT50-MGT12-90	965.408	MGT12	M5-M12 / P1/8	41	20	90	30 - 200
BBT50-MGT20-105	965.409	MGT20	M10-M20 / P1/4-P1/2	54	30	105	35 - 150

1. BIG-PLUS® tools can be used in machining centers with non BIG-PLUS® spindles.
2. Tap holder is to be ordered separately.
3. Synchronized tapping function is required on the machine.

MEGA Synchro Tapping Holder MGT36

For large Tap MGT36

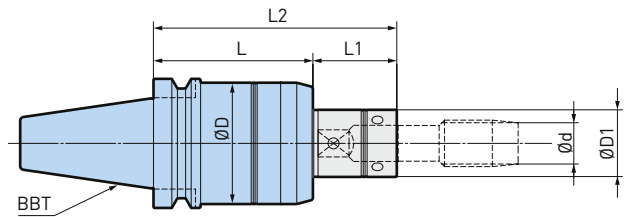
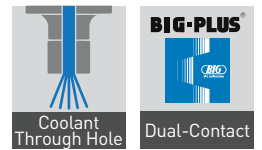

M20 - M36

Model	Order No.	Ød	ØD	ØD1	L	L1	L2
BBT50-MGT36-125	800.323	M20-36 / P1/4-P1	94	38-52	125	65	190

1. BIG-PLUS® tools can be used in machining centers with non BIG-PLUS® spindles.
2. Tap holder is to be ordered separately.
3. Synchronized tapping function is required on the machine.

Accessories & Spare Parts

Tap Holder	MEGA Wrenches	Accessories
<p>▶ 356-363</p>	<p>▶ 351</p>	<p>▶ 364-365</p>

MEGA Synchro Tapping Holder MGT3

For small tapping tools: Type MGT3

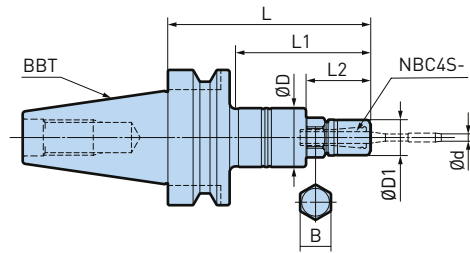

A.1

M1 - M3

Model	Order No.	Ød	ØD	ØD1	L	L1	L2	B
BBT30-MGT3-70	965.400	M1 - M3	20	12	70	46	22	12
BBT40-MGT3-90	805.723	M1 - M3	20	12	90	61	22	12

1. BIG-PLUS® tools can be used in machining centers with non BIG-PLUS® spindles.
2. Synchroized tapping function is required on the machine.
3. MEGA nut is included in delivery.
4. MEGA wrench (MGR12) and common spanner (12 mm) are required to clamp/unclamp the tap.

Micro Collet for MGT3

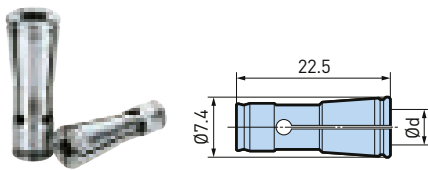

Model	Order No.	Tapping Range			Tap Shank
		DIN 371	ISO 529	JIS	Ød
NBC4S-2.5AA	961.468	M1 - M1.8	M2		2.5
-2.8AA	968.353	M2 - M2.6	M2.2, M2.5		2.8
-3.0AA	961.470	-	-	M1 - M2.6	3.0
-3.1AA	968.355	-	M3		3.15
-3.5AA	961.472	M3	-		3.5
-4.0AA	961.474	-	-	M3	4.0

1. Other sizes available. Please refer to micro collet.

Accessories & Spare Parts

MEGA Wrenches



► 351

Angle Head New Baby Chuck Compact

Significantly reduces work time through systematized multilateral machining.



A.1

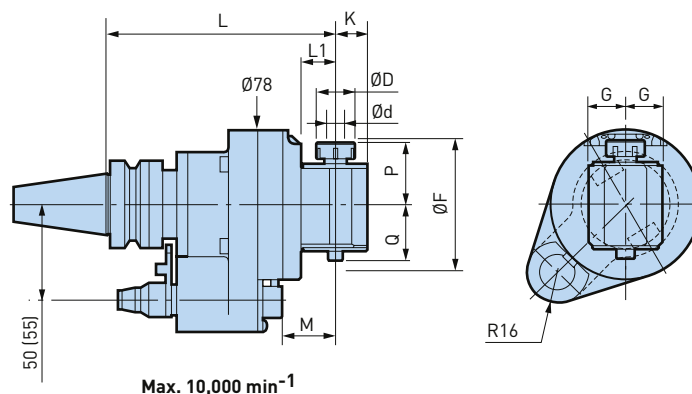

ø0.25 - 13mm

Model	Order No.	Ød	ØD	G	K	L	L1	M	P	Q	ØF	Collet Model
BBT30-AG90-6-120	804.661	0,25 - 6	20	19,5	17	120	18,5	28,5	33	29	65	NBC6
BBT30-AG90-8-125	804.825	0,5 - 8	25	21,5	21	125	23,5	33,5	42	41	87	NBC8
BBT30-AG90-10-125	804.836	1,5 - 10	30	24,5	25	125	23,5	33,5	45	43	92	NBC10
BBT30-AG90-13-125	804.838	2,5 - 13	35	24,5	25	125	23,5	33,5	52	45	102	NBC13

1. Nut is included.
2. Wrench is included.
3. Exclusive Stop Block is required.
4. No puede utilizarse la pinza New Baby para fresado (NBC - EAA).
5. The cutting tool rotates in reverse to the machine spindle.
6. Collet is not included.
7. The angles of the locating pin to the drive key groove and direction of cutting edge are freely adjustable.
8. When used with stop block peripheral cooling is possible

Accessories & Spare Parts

New Baby Collets



► 327

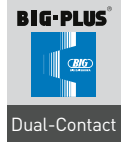

New Baby Chuck Type

The Angle Head has an integrated New Baby Chuck, resulting in high precision. Available in various sizes to meet specific production requirements.

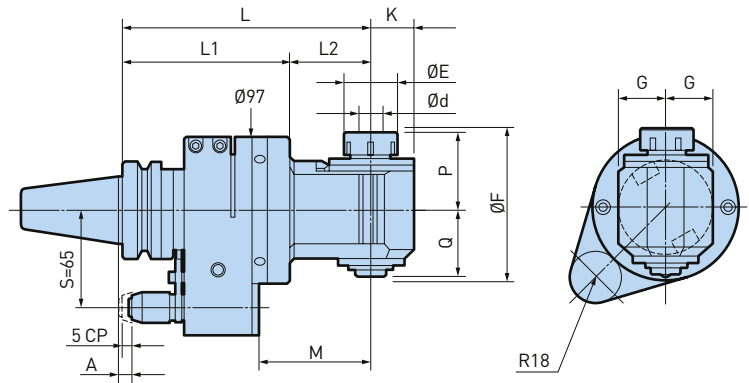

A.1

BBT40

ø0.25 - 20mm

Model	Order No.	Ød	ØE	ØF	L	L1	L2	G	K	M	P	Q	max. min-1	Collet Model
BBT40-AG90/NBS6-170	802.463	0.25 - 6	20	67	170	115	55	21	17	77	33	29	6000	NBC6
BBT40-AG90/NBS6-200	802.465	0.25 - 6	20	67	200	115	85	21	17	107	33	29	6000	NBC6
BBT40-AG90/NBS6-230	802.467	0.25 - 6	20	67	230	115	115	21	17	137	33	29	6000	NBC6
BBT40-AG90/NBS6-260	802.469	0.25 - 6	20	67	260	115	145	21	17	167	33	29	6000	NBC6
BBT40-AG90/NBS10-170	802.449	1.5 - 10	30	91	170	115	55	30	25	77	45	43	6000	NBC10
BBT40-AG90/NBS10-200	802.451	1.5 - 10	30	91	200	115	85	30	25	107	45	43	6000	NBC10
BBT40-AG90/NBS10-230	802.453	1.5 - 10	30	91	230	115	115	30	25	137	45	43	6000	NBC10
BBT40-AG90/NBS13-170	802.455	2.5 - 13	35	101	170	115	55	31	28	77	52	45	6000	NBC13
BBT40-AG90/NBS13-200	802.457	2.5 - 13	35	101	200	115	85	31	28	107	52	45	6000	NBC13
BBT40-AG90/NBS13-230	802.459	2.5 - 13	35	101	230	115	115	31	28	137	52	45	6000	NBC13
BBT40-AG90/NBS20S-165S	802.462	2.5 - 20	46	132	165	112	53	35	33	72	65	62	3000	NBC20

continues on the next page

A.1

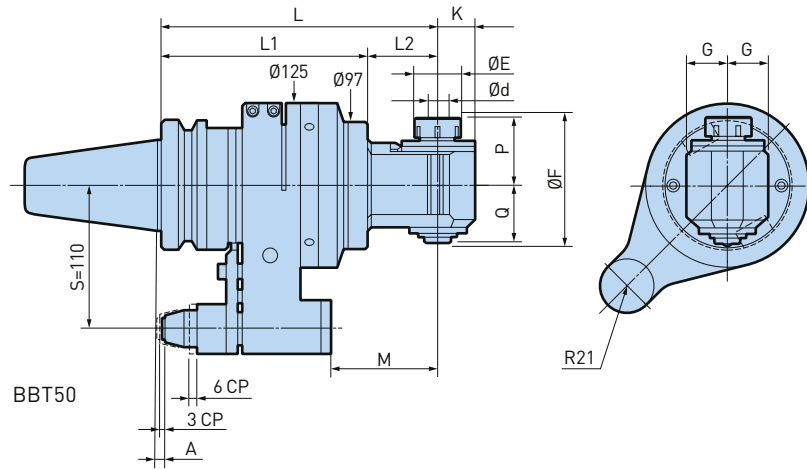

Model	Order No.	Ød	ØE	ØF	L	L1	L2	G	K	M	P	Q	max. min-1	Collet Model
BBT50-AG90/NBS6-215	802.515	0.25 - 6	20	67	215	160	55	21	17	82	33	29	6000	NBC6
BBT50-AG90/NBS6-245	802.518	0.25 - 6	20	67	245	160	85	21	17	112	33	29	6000	NBC6
BBT50-AG90/NBS6-275	802.521	0.25 - 6	20	67	275	160	115	21	17	142	33	29	6000	NBC6
BBT50-AG90/NBS6-305	802.524	0.25 - 6	20	67	305	160	145	21	17	172	33	29	6000	NBC6
BBT50-AG90/NBS10-215	802.494	1.5 - 10	30	91	215	160	55	30	25	82	45	43	6000	NBC10
BBT50-AG90/NBS10-245	802.497	1.5 - 10	30	91	245	160	85	30	25	112	45	43	6000	NBC10
BBT50-AG90/NBS10-275	802.500	1.5 - 10	30	91	275	160	115	30	25	142	45	43	6000	NBC10
BBT50-AG90/NBS13-215	802.503	2.5 - 13	35	101	215	160	55	31	28	82	52	45	6000	NBC13
BBT50-AG90/NBS13-245	802.506	2.5 - 13	35	101	245	160	85	31	28	112	52	45	6000	NBC13
BBT50-AG90/NBS13-275	802.509	2.5 - 13	35	101	275	160	115	31	28	142	52	45	6000	NBC13
BBT50-AG90/NBS20-230	802.512	2.5 - 20	46	132	230	160	70	35	35	97	65	62	3000	NBC20

1. BIG-PLUS® tools can be used in machining centers with non BIG-PLUS® spindles.
2. Exclusive Stop Block is required.
3. The standard fixed length A is 8 mm for BBT40 and 6 mm for BBT50. Other lengths are available upon request.
4. Order No. for BBT50 is with S = 110. S = 80 type for BBT50 is available upon request.
5. Nut and wrench are included.
6. New Baby Collet is to be ordered separately
7. No puede utilizarse la pinza New Baby para fresado (NBC - EAA).
8. Coolant can be supplied through the locating pin.
9. „ØF“ indicates the minimum dimension for access into the bore
10. „CP“ indicates compression.

Accessories & Spare Parts

<p>New Baby Collets</p>  <p>▶ 327</p>	<p>Semi-Finished Stop Blocks</p>  <p>▶ 377</p>
--	---

New Baby Chuck Type Extra Long Type

For drilling and key slotting in deep cavities of large workpieces.

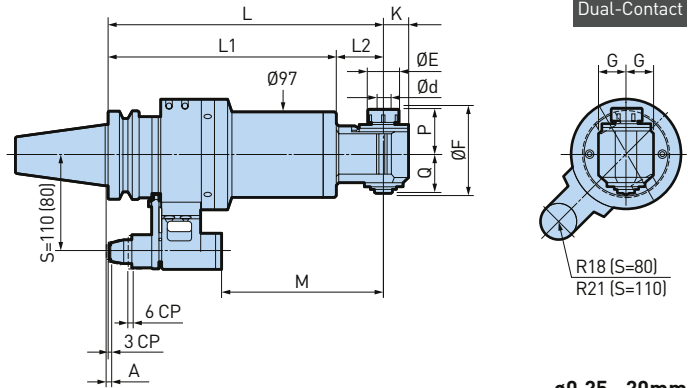

A.1

ø0.25 - 20mm

Model	Order No.	Ød	ØE	ØF	L	L1	L2	G	K	M	P	Q	max. min-1	Collet Model
BBT50-AG90/NBS6-315LS	805.035	0.25 - 6	20	67	315	260	55	21	17	182	33	29	6000	NBC6
BBT50-AG90/NBS6-345LS	805.036	0.25 - 6	20	67	345	260	85	21	17	212	33	29	6000	NBC6
BBT50-AG90/NBS6-375LS	805.037	0.25 - 6	20	67	375	260	115	21	17	242	33	29	6000	NBC6
BBT50-AG90/NBS6-405LS	805.038	0.25 - 6	20	67	405	260	145	21	17	272	33	29	6000	NBC6
BBT50-AG90/NBS6-415LS	805.039	0.25 - 6	20	67	415	360	55	21	17	282	33	29	6000	NBC6
BBT50-AG90/NBS6-445LS	805.040	0.25 - 6	20	67	445	360	85	21	17	312	33	29	6000	NBC6
BBT50-AG90/NBS6-475LS	805.041	0.25 - 6	20	67	475	360	115	21	17	342	33	29	6000	NBC6
BBT50-AG90/NBS6-505LS	805.042	0.25 - 6	20	67	505	360	145	21	17	372	33	29	6000	NBC6
BBT50-AG90/NBS6-515LS	805.043	0.25 - 6	20	67	515	460	55	21	17	382	33	29	6000	NBC6
BBT50-AG90/NBS6-545LS	805.044	0.25 - 6	20	67	545	460	85	21	17	412	33	29	6000	NBC6
BBT50-AG90/NBS6-575LS	805.045	0.25 - 6	20	67	575	460	115	21	17	442	33	29	6000	NBC6
BBT50-AG90/NBS6-605LS	805.046	0.25 - 6	20	67	605	460	145	21	17	472	33	29	6000	NBC6
BBT50-AG90/NBS10-315LS	805.047	1.5 - 10	30	91	315	260	55	30	25	182	45	43	6000	NBC10
BBT50-AG90/NBS10-345LS	805.048	1.5 - 10	30	91	345	260	85	30	25	212	45	43	6000	NBC10
BBT50-AG90/NBS10-375LS	805.049	1.5 - 10	30	91	375	260	115	30	25	242	45	43	6000	NBC10
BBT50-AG90/NBS10-415LS	805.050	1.5 - 10	30	91	415	360	55	30	25	282	45	43	6000	NBC10
BBT50-AG90/NBS10-445LS	805.051	1.5 - 10	30	91	445	360	85	30	25	312	45	43	6000	NBC10
BBT50-AG90/NBS10-475LS	805.052	1.5 - 10	30	91	475	360	115	30	25	342	45	43	6000	NBC10
BBT50-AG90/NBS10-515LS	805.053	1.5 - 10	30	91	515	460	55	30	25	382	45	43	6000	NBC10
BBT50-AG90/NBS10-545LS	805.054	1.5 - 10	30	91	545	460	85	30	25	412	45	43	6000	NBC10
BBT50-AG90/NBS10-575LS	805.055	1.5 - 10	30	91	575	460	115	30	25	442	45	43	6000	NBC10
BBT50-AG90/NBS13-315LS	805.057	2.5 - 13	35	101	315	260	55	31	28	182	52	45	6000	NBC13
BBT50-AG90/NBS13-345LS	805.058	2.5 - 13	35	101	345	260	85	31	28	212	52	45	6000	NBC13
BBT50-AG90/NBS13-375LS	805.060	2.5 - 13	35	101	375	260	115	31	28	242	52	45	6000	NBC13
BBT50-AG90/NBS13-415LS	805.061	2.5 - 13	35	101	415	360	55	31	28	282	52	45	6000	NBC13
BBT50-AG90/NBS13-445LS	805.062	2.5 - 13	35	101	445	360	85	31	28	312	52	45	6000	NBC13
BBT50-AG90/NBS13-475LS	805.063	2.5 - 13	35	101	475	360	115	31	28	342	52	45	6000	NBC13
BBT50-AG90/NBS13-515LS	805.064	2.5 - 13	35	101	515	460	55	31	28	382	52	45	6000	NBC13
BBT50-AG90/NBS13-545LS	805.065	2.5 - 13	35	101	545	460	85	31	28	412	52	45	6000	NBC13
BBT50-AG90/NBS13-575LS	805.066	2.5 - 13	35	101	575	460	115	31	28	442	52	45	6000	NBC13
BBT50-AG90/NBS20-330LS	805.067	2.5 - 20	46	132	330	260	70	35	35	197	65	62	3000	NBC20
BBT50-AG90/NBS20-430LS	805.069	2.5 - 20	46	132	430	360	70	35	35	297	65	62	3000	NBC20
BBT50-AG90/NBS20-530LS	805.070	2.5 - 20	46	132	530	460	70	35	35	397	65	62	3000	NBC20

1. BIG-PLUS® tools can be used in machining centers with non BIG-PLUS® spindles.
2. Exclusive Stop Block is required.
3. The standard length A is 6 mm.
4. Order No. for BBT50 is with S = 110. S = 80 type for BBT50 is available upon request.
5. Clamping nut and wrench are included.
6. New Baby Collet is to be ordered separately
7. No puede utilizarse la pinza New Baby para fresado (NBC - EAA).
8. Coolant can be supplied through the locating pin.
9. „CP” indicates compression.
10. „ØF” indicates the minimum dimension for access into the bore

Accessories & Spare Parts

<p>New Baby Collets</p>  <p>▶ 327</p>	<p>Semi-Finished Stop Blocks</p>  <p>▶ 377</p>
---	--



Angle Head Twin Head Type

Twin spindle head with a compact design. Symmetrical machining can be performed using one unit, contributing to the reduction of the number of magazines.

A.1

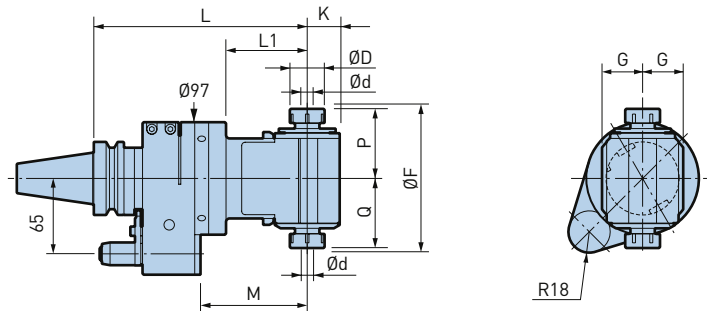

Fig. 1

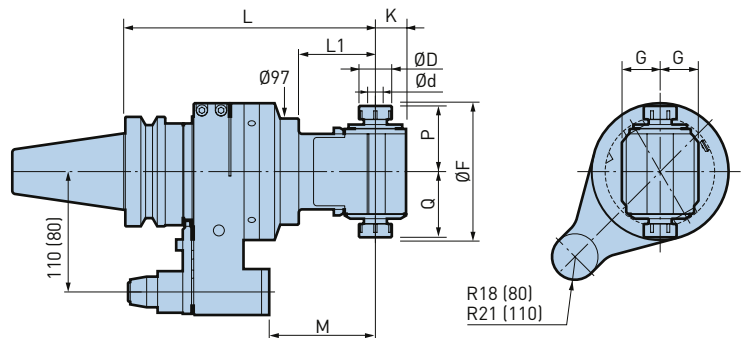

Fig. 2

Model	Order No.	Fig.	Ød	ØD	G	K	L	L1	M	P	Q	ØF	Collet Model
BBT40-AG90/NBS10W-185	101124.001.0	1	1,5 - 10	31	31	28	185	70	92	60	60	24	NBC10
BBT50-AG90/NBS10W-230	101124.002.0	2	1,5 - 10	30	31	28	230	70	97	60	60	124	NBC10

1. Nut is included.
2. Wrench is included.
3. Exclusive Stop Block is required.
4. No puede utilizarse la pinza New Baby para fresado (NBC - EAA).
5. The cutting tool rotates in reverse to the machine spindle.
6. Collet is not included.
7. The angles of the locating pin to the drive key groove and direction of cutting edge are freely adjustable.
8. When used with stop block peripheral cooling is possible
9. Automatic tool change may not be available, depending on machine models.
10. Output spindles do not rotate in the same direction simultaneously.
11. The standard fixed length A is 8 mm for BBT40 and 6 mm for BBT50. Other lengths are available upon request.
12. Order No. for BBT50 is with S = 110. S = 80 type for BBT50 is available upon request.

Accessories & Spare Parts

New Baby Collets



▶ 327

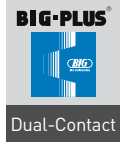

OAG Type

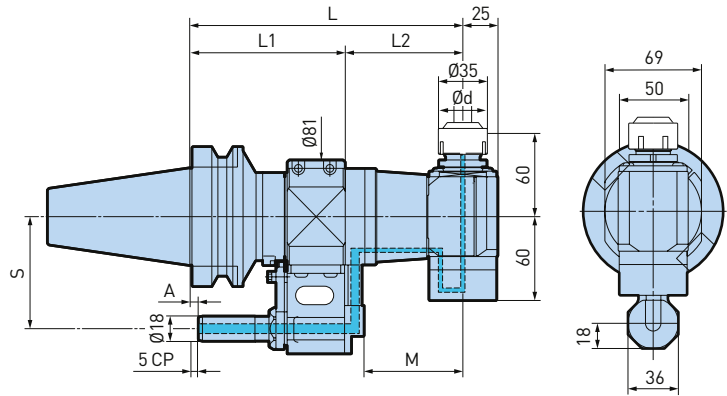

A.1

ø3 - 13mm

Model	Order No.	Ød	L	L1	L2	M	max. min-1	Collet Model	Nut Model
BBT40-OAG90-13-170-65	802.482	2.5 - 13	170	86	84	70.5	5000	NBC13	BPS13
BBT50-OAG90-13-195-80	802.545	2.5 - 13	195	111	84	70.5	5000	NBC13	BPS13

1. BIG-PLUS® tools can be used in machining centers with non BIG-PLUS® spindles.
2. Exclusive Stop Block is required.
3. The standard length A is 6 mm.
4. Standard "S" is 80 mm for BBT50 and 65 mm for BBT40.
5. Wrench is included.
6. New Baby collet and Baby Perfect Seal (BPS13) are to be ordered separately.
7. No puede utilizarse la pinza New Baby para fresado (NBC - EAA).
8. „CP” indicates compression.

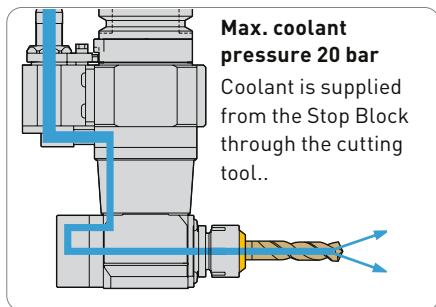

Accessories & Spare Parts

<p>Baby Perfect Seals</p> <p>▶ 338</p>	<p>New Baby Collets</p> <p>▶ 327</p>	<p>Semi-Finished Stop Blocks</p> <p>▶ 377</p>
--	--------------------------------------	---

Light Weight Type

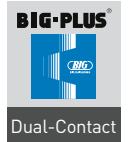

A.1

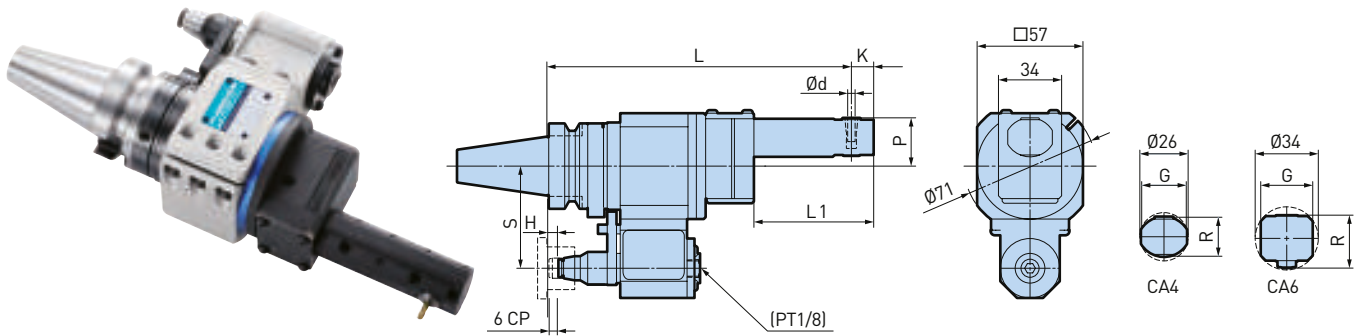



ø3 - 6mm

Model	Order No.	Ød	L	L1	K	P	G	R	Ratio	max. min-1	Collet Model
BBT30-AG90-CA4SG-164	805.570	3 - 4	164	64.5	12	26	24	21	1:1.13	2000	CA4
BBT30-AG90-CA6SG-164	805.571	3 - 6	164	67	14.5	28	28	28.5	1:0.91	2000	CA6

1. BIG-PLUS® tools can be used in machining centers with non BIG-PLUS® spindles.
2. Exclusive Stop Block is required.
3. H and S dimensions must be indicated before ordering.
4. Tolerance of the cutting tool shank must be within h7.
5. Exclusive collet is to be ordered separately.
6. „CP“ indicates compression.

Accessories & Spare Parts

<p>Collet for Angle Head</p>  <p>▶ 366</p>	<p>Semi-Finished Stop Blocks</p>  <p>▶ 377</p>
---	---

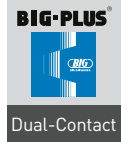

Angle Head Compact Type

Compact and lightweight while fully equipped with the functions and accuracy required in drilling.

A.1

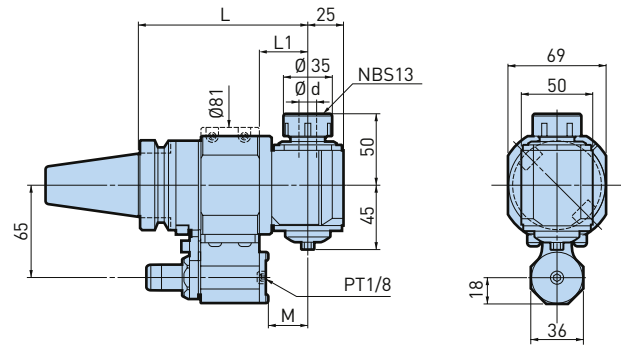

Fig. 1

Max. 5,000min⁻¹

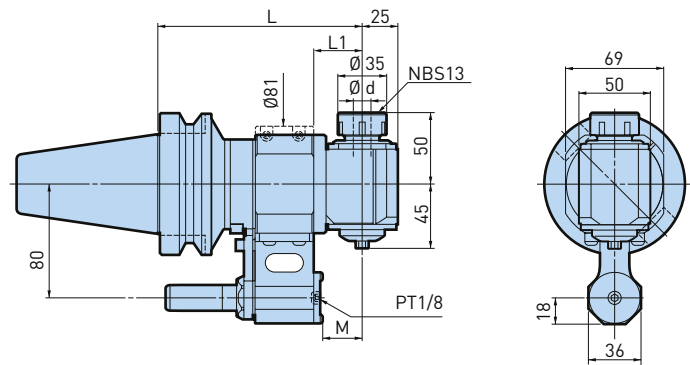

Fig. 2

Max. 5,000min⁻¹

Model	Order No.	Fig.	Ød	L	L1	M	Collet Model
BBT40-AG90-13-120	802.471	1	2.5 - 13	120	34	27.85	NBS13
BBT40-AG90-13-170	802.472	1	2.5 - 13	170	84	77.85	NBS13
BBT50-AG90-13-145	802.527	2	2.5 - 13	145	34	27.85	NBS13
BBT50-AG90-13-195	802.528	2	2.5 - 13	195	84	77.85	NBS13

1. Nut is included.
2. Wrench is included.
3. Exclusive Stop Block is required.
4. No puede utilizarse la pinza New Baby para fresado (NBC - EAA).
5. The cutting tool rotates in reverse to the machine spindle.
6. Collet is not included.
7. The angles of the locating pin to the drive key groove and direction of cutting edge are freely adjustable.
8. When used with stop block peripheral cooling is possible
9. Automatic tool change may not be available, depending on machine models.

Accessories & Spare Parts

New Baby Collets



▶ 327



Small Bore Type

Angular operation in a $\varnothing 30$ mm bore (min.) is possible. Modular heads enhance versatility. Head is aligned with spindle center for easy programming.

A.1

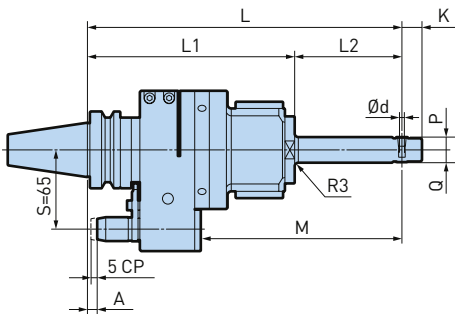
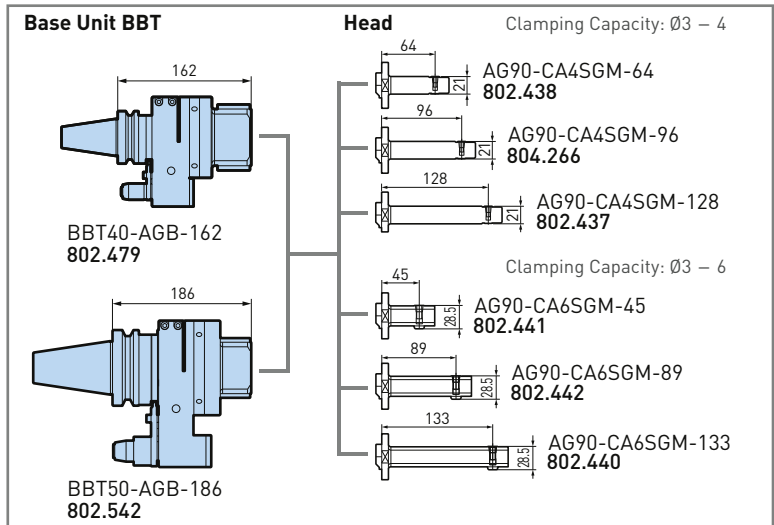

BBT40

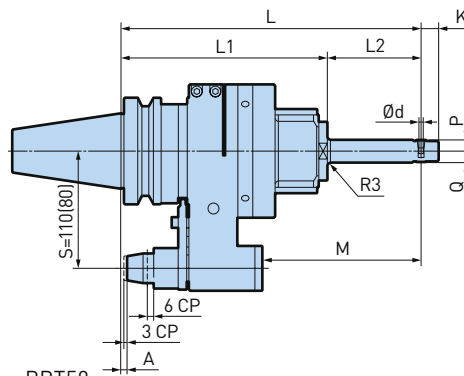
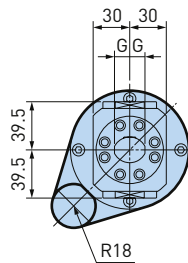

BBT50

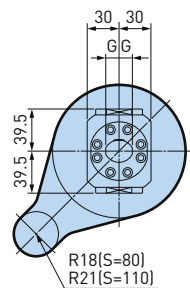

$\varnothing 3 - 6$ mm

Model	Order No.	Base Unit	Head	$\varnothing d$	L	L1	L2	G	K	M	P	Q	Ratio
BBT40-AG90-CA4SGM-226	802.473	BBT40-AGB-162	AG90-CA4SGM-64	3 - 4	226	170	56	12.5	16.5	133	10.5	10.5	1:1.06
BBT40-AG90-CA4SGM-258	802.474	BBT40-AGB-162	AG90-CA4SGM-96	3 - 4	258	170	88	12.5	16.5	165	10.5	10.5	1:1.06
BBT40-AG90-CA4SGM-290	802.475	BBT40-AGB-162	AG90-CA4SGM-128	3 - 4	290	170	120	12.5	16.5	197	10.5	10.5	1:1.06
BBT40-AG90-CA6SGM-207	802.476	BBT40-AGB-162	AG90-CA6SGM-45	3 - 6	207	170	37	15	20	114	12.5	16	1:0.77
BBT40-AG90-CA6SGM-251	802.477	BBT40-AGB-162	AG90-CA6SGM-89	3 - 6	251	170	81	15	20	158	12.5	16	1:0.77
BBT40-AG90-CA6SGM-295	802.478	BBT40-AGB-162	AG90-CA6SGM-133	3 - 6	295	170	125	15	20	202	12.5	16	1:0.77
BBT50-AG90-CA4SGM-250	802.529	BBT50-AGB-186	AG90-CA4SGM-64	3 - 4	250	194	56	12.5	16.5	117	10.5	10.5	1:1.06
BBT50-AG90-CA4SGM-282	802.531	BBT50-AGB-186	AG90-CA4SGM-96	3 - 4	282	194	88	12.5	16.5	149	10.5	10.5	1:1.06
BBT50-AG90-CA4SGM-314	802.533	BBT50-AGB-186	AG90-CA4SGM-128	3 - 4	314	194	120	12.5	16.5	181	10.5	10.5	1:1.06
BBT50-AG90-CA6SGM-231	802.535	BBT50-AGB-186	AG90-CA6SGM-45	3 - 6	231	194	37	15	20	98	12.5	16	1:0.77
BBT50-AG90-CA6SGM-275	802.537	BBT50-AGB-186	AG90-CA6SGM-89	3 - 6	275	194	81	15	20	142	12.5	16	1:0.77
BBT50-AG90-CA6SGM-319	802.539	BBT50-AGB-186	AG90-CA6SGM-133	3 - 6	319	194	125	15	20	186	12.5	16	1:0.77

- BIG-PLUS® tools can be used in machining centers with non BIG-PLUS® spindles.
- Exclusive Stop Block is required.
- The standard fixed length A is 8 mm for BBT40 and 6 mm for BBT50. Other lengths are available upon request.
- Order No. for BBT50 is with S = 110. S = 80 type for BBT50 is available upon request.
- Coolant-through hole is not available.
- Exclusive collet is to be ordered separately.
- „CP” indicates compression.
- max. 2000 min-1

Accessories & Spare Parts

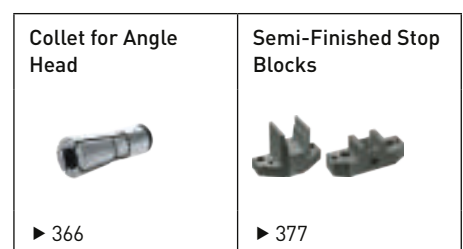



HMC Type

Improved versatility is achieved from the 32 mm Milling Chuck by using parallel reduction collets and other accessories.

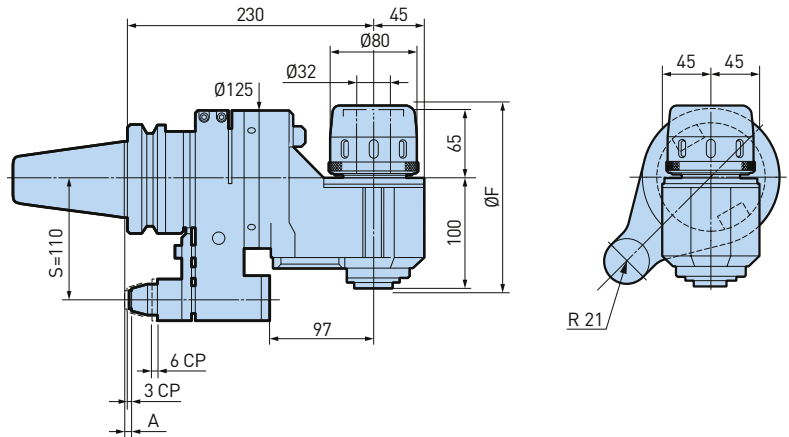

A.1

ø6 - 32mm

Model	Order No.	ØF	max. min-1
BBT50-AG90/HMC32-230-110	802.492	175	3000
BBT50-AG90/HMC32-230S-110	802.493	175	3000

1. BIG-PLUS® tools can be used in machining centers with non BIG-PLUS® spindles.
2. Exclusive Stop Block is required.
3. Models with "S" at the end are high rigidity type.
4. The standard length A is 6 mm.
5. Order No. is with S = 110. S = 80 type is available upon request.
6. Wrench (FK80-90) is included.
7. Coolant can be supplied through the locating pin.
8. „CP" indicates compression.
9. „ØF" indicates the minimum dimension for access into the bore

Accessories & Spare Parts

<p>C Collets</p>  <p>▶ 349</p>	<p>Semi-Finished Stop Blocks</p>  <p>▶ 377</p>	<p>FK Wrenches</p>  <p>▶ 352</p>
---	---	---



Build-Up Type

Designed for greater rigidity by having the face of the spindle bore in line with the center of the machine spindle. Also helps minimize interference problems with ATC and storage problems within the magazine.

A.1

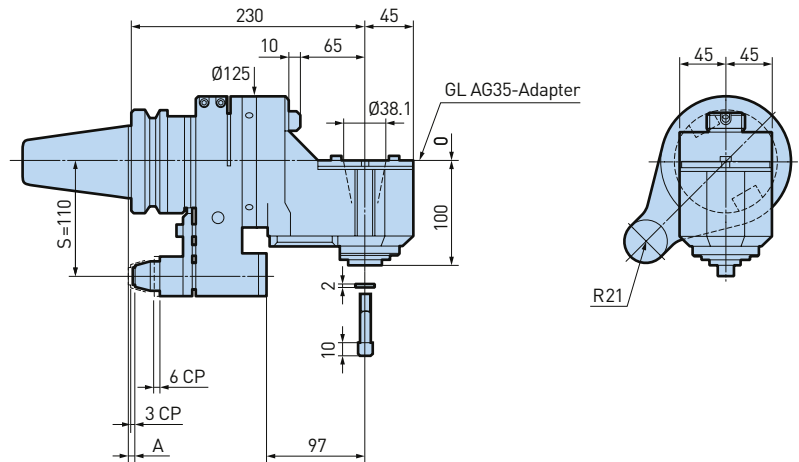

Model	Order No.	max. min-1	Connection tool side
BBT50-AG90/AGH35-230-110	802.489	3000	AGH35
BBT50-AG90/AGH35-230S-110	802.490	3000	AGH35

1. BIG-PLUS® tools can be used in machining centers with non BIG-PLUS® spindles.
2. Exclusive Stop Block is required.
3. Models with "S" at the end are high rigidity type.
4. The standard length A is 6 mm.
5. Order No. is with S = 110. S = 80 type is available upon request.
6. Coolant can be supplied through the locating pin.
7. „CP" indicates compression.

Accessories & Spare Parts

Semi-Finished Stop Blocks



► 377

AG35 adapters

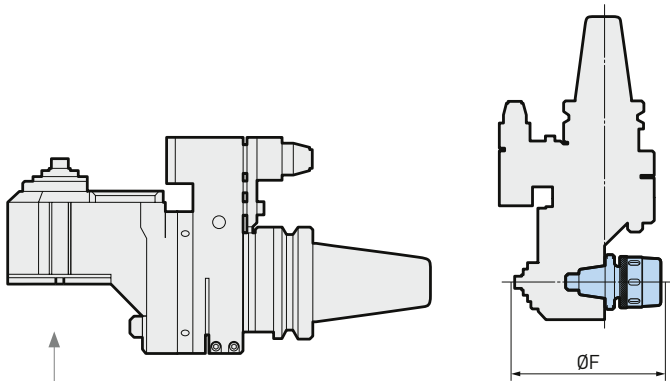

AG35 adapters New Baby Chuck

Model	Order No.	Ød	L	ØC	ØF	Collet Model
AG35-NBS10	962.793	1.5 - 10	47	30	162	NBC10
AG35-NBS13	962.794	2.5 - 13	54	35	168	NBC13
AG35-NBS16	962.795	2.5 - 16	54	42	170	NBC16
AG35-NBS20	962.796	2.5 - 20	54	46	170	NBC20

1. New baby collet and wrench are to be ordered separately.

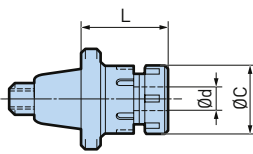

AG35 adapters New Hi-Power Milling Chuck

Model	Order No.	Ød	L	ØC	ØF	Head
AG35-HMC20S	802.742	20	60	50	178	AG35

1. Wrench (FK45-50L) is included.

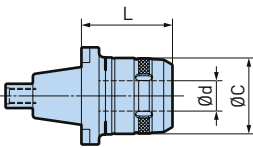

AG35 adapters Auto Tapper Type B (automatic depth control)

Model	Order No.	Ød	ØC	L	H	Head
AG35-ATB12E	802.435	M4 - M12	40.5	80	72	AG35
AG35-ATB20E	802.436	M8 - M20	57.5	115	102.5	AG35

1. Please contact BIG KAISER agent for tap collet.

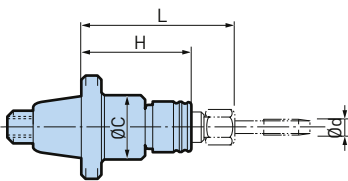

AG35 adapters Face Mill Arbor

Model	Order No.	ØD	L	H	Head
AG35-FMH22-30	802.740	22	30	18	AG35
AG35-FMH27-20	802.741	27	20	20	AG35

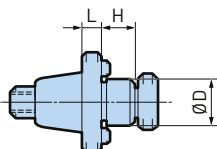

AG35 adapters Morse Taper Adapter

Model	Order No.	Ød	MT No.	L	ØC	ØF	Head
AG35-MT1	962.785	12.065	1	50	24	164	AG35
AG35-MT2	962.786	17.78	2	60	32	180	AG35

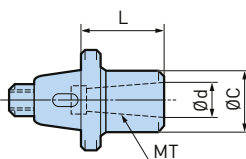



Universal Type

Suitable for cutting angles between 0° and 90°. In addition to that the cutter head can be rotated a full 360°, increasing flexibility!

A.1

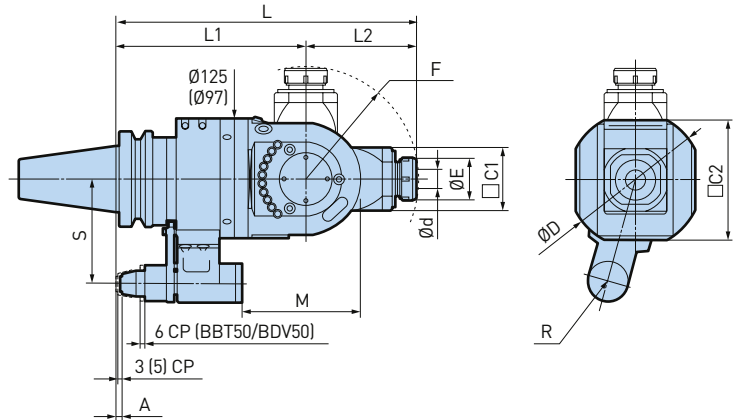

Model	Order No.	Ød	ØD	ØE	C1	C2	L	L1	L2	M	F	R	S	max. min-1	Collet Model
BBT40-AGU/NBS13-270	802.480	2.5 - 13	115	35	51	97	270	170	100	124	102	18	65	6000	NBC13
BBT50-AGU/NBS20-315	802.318	2.5 - 20	140	46	65	125	315	200	115	125	118	21	110	4000	NBC20

1. BIG-PLUS® tools can be used in machining centers with non BIG-PLUS® spindles.
2. Exclusive Stop Block is required.
3. The standard fixed length A is 8 mm for BBT40 and 6 mm for BBT50. Other lengths are available upon request.
4. Order No. for BBT50 is with S = 110. S = 80 type for BBT50 is available upon request.
5. Figures in () in the drawing indicate dimensions for BBT40.
6. Nut and wrench are included.
7. Coolant can be supplied through the locating pin.
8. „CP“ indicates compression.



Easily adjustable spindle angle from 0° to 90°.



Unique setting mechanism enables the spindle angle to be precisely set at 1° increments.



Specially selected materials and special design for clamping the head guarantees rigidity for even end milling applications

Accessories & Spare Parts

<p>New Baby Collets</p>  <p>▶ 327</p>	<p>Semi-Finished Stop Blocks</p>  <p>▶ 377</p>
---	--

AGU30 Type

Spindle angle is adjustable from 0° to 30°. Large swivel flange assures high rigidity.

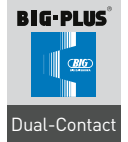

A.1

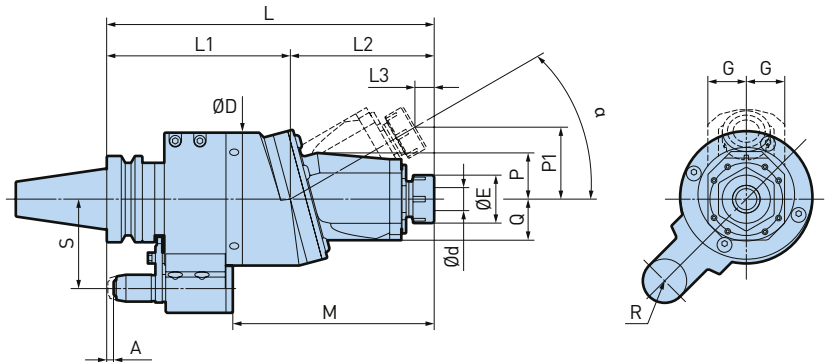

Model	Order No.	Ød	ØD	ØE	L	L1	L2	L3	G	Q	P	P1 max.	R	S	M	max. min-1	Collet Model
BBT40-AGU30/NBS13-240	802.481	2.5 - 13	97	35	240	135	105	14	29	30	34	52.5	18	65	147	6000	NBC13
BBT50-AGU30/NBS20-295	802.544	2.5 - 20	125	46	295	165	130	17	36.5	39	45	65	21	110	162	4000	NBC20

1. BIG-PLUS® tools can be used in machining centers with non BIG-PLUS® spindles.
2. Exclusive Stop Block is required.
3. The standard fixed length A is 8 mm for BBT40 and 6 mm for BBT50. Other lengths are available upon request.
4. Order No. for BBT50 is with S = 110. S = 80 type for BBT50 is available upon request.
5. Coolant can be supplied through the locating pin.
6. New baby nut, wrench and setting disc are included.

Setting Disc (Included Accessory)

For precise adjustment of the spindle angle or direction.

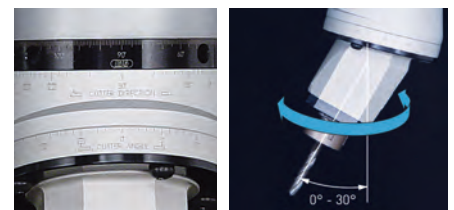
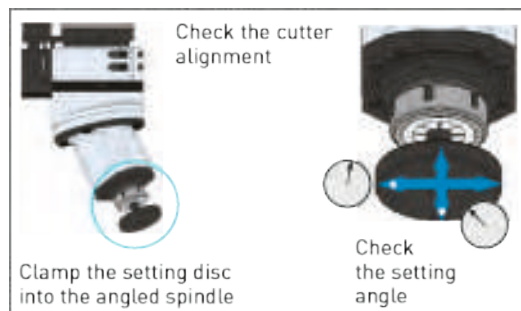
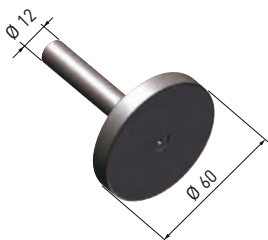

Spindle angle is easily adjustable from 0° to 30° using the scale indication on the body.

Accessories & Spare Parts

<p>New Baby Collets</p> <p>▶ 327</p>	<p>Semi-Finished Stop Blocks</p> <p>▶ 377</p>
---	--

Application Examples

A.1

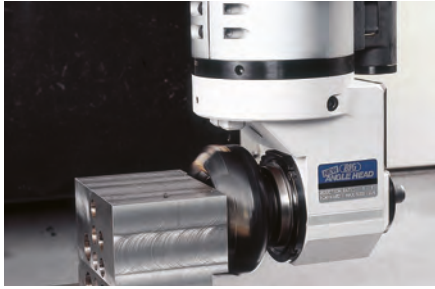

AG90-Series (Build-Up Type)

Standard Type

BBT50-AG90/AGH35-230
(with AG35-FMA25.4-20)
Workpiece: Carbon Steel C55
Cutter: 80 mm Face Mill
Cutting Depth: 2 mm
Spindle Speed: 600 min⁻¹
Cutting Speed: 150 m/min
Cutting Feed: 360 mm/min

S-Type

BBT50-AG90/AGH35-230S
(with AG35-FMA25.4-20)
Workpiece: Carbon Steel C55
Cutter: 80 mm Face Mill
Cutting Depth: 3 mm
Spindle Speed: 600 min⁻¹
Cutting Speed: 150 m/min
Cutting Feed: 360 mm/min



AG90-Series (HMC Type)

Standard Type

BBT50-AG90/HMC32-230
Workpiece: Carbon Steel C55
Cutter: 20 mm Face Mill
Cutting Depth: 3 mm
Spindle Speed: 400 min⁻¹
Cutting Speed: 25 m/min
Cutting Feed: 72 mm/min

S-Type

BBT50-AG90/HMC32-230S
Workpiece: Carbon Steel C55
Cutter: 20 mm Face Mill
Cutting Depth: 4 mm
Spindle Speed: 400 min⁻¹
Cutting Speed: 25 m/min
Cutting Feed: 72 mm/min

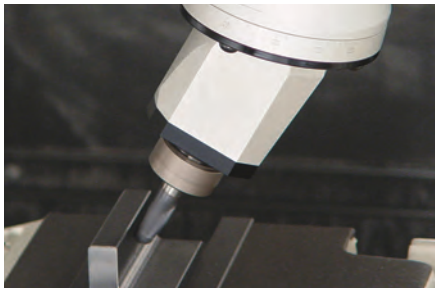

AGU-Series (AGU30 Type)

BBT40-AGU30/NBS13-240
Workpiece: Pre-hardened steel (HRC40)
Cutter: R5 2-flute carbide ball end mill
Cutting Depth: Ad = 0.1 mm
Spindle Speed: 6 000 min⁻¹
Peck Feed: Pf = 0.4
Cutting Speed: 90 m/min
Cutting Feed: 900 mm/min

Special Designs

Our long experience and expertise enables us to design and manufacture special custom made Angle Heads for almost any customer application.

Special angle



Special length



Coolant feeder



BBT30



Air Turbine Spindle Center Through Type



A.1

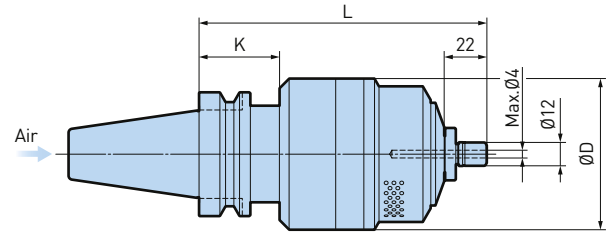

Ø0.5 - 4mm

Model	Order No.	Operation Speed (min-1)	ØD	L	K	Nut Model
BBT40-RBX5C-4S-150	802.403	40000 - 50000	96	150	43	MGN4S
BBT40-RBX7C-4S-150	802.409	60000 - 80000	78	150	43	MGN4S
BBT50-RBX5C-4S-160	802.415	40000 - 50000	96	160	53	MGN4S
BBT50-RBX7C-4S-160	802.420	60000 - 80000	78	160	53	MGN4S

1. BIG-PLUS® tools can be used in machining centers with non BIG-PLUS® spindles.
2. Nut and wrench are included.
3. Collet (NBC4S-_) and XF1 (air unit) are to be ordered separately.

Caution

Clean air is an essential condition for the use of this product. Therefore, coolant should never be supplied through the spindle of the machine using the Air Turbine Spindle.

Accessories & Spare Parts

<p>MEGA Nuts</p> <p>▶ 326</p>	<p>Micro Collets</p> <p>▶ 324</p>	<p>MEGA Wrenches</p> <p>▶ 351</p>	<p>Air Filter Regulator for RBX</p> <p>▶ 366</p>
-------------------------------	-----------------------------------	-----------------------------------	--

Air Turbine Spindle Side Through Type



A.1

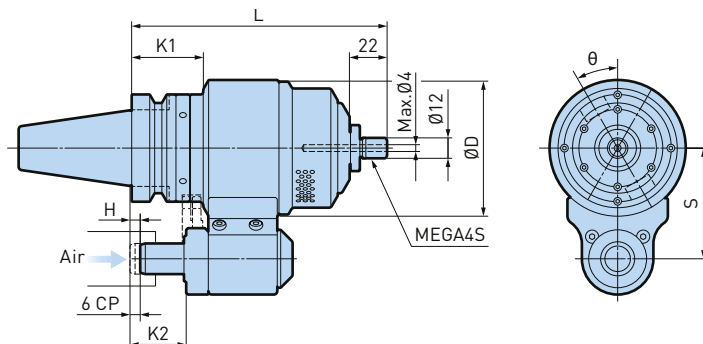

Ø0.5 - 4mm

Model	Order No.	Operation Speed (min-1)	ØD	L	K1	K2	S	H	Nut Model
BBT30-RBX7-4S-152	802.395	60000 - 80000	80	152	28	33	55	-10 - 22	MGN4S
BBT40-RBX5-4S-151	802.398	40000 - 50000	96	151	43	33	65	-24 - 21	MGN4S
BBT40-RBX7-4S-151	802.404	60000 - 80000	80	151	43	33	65	-24 - 21	MGN4S
BBT50-RBX5-4S-166	802.411	40000 - 50000	100	166	58	48	80	-9 - 36	MGN4S
BBT50-RBX7-4S-166	802.416	60000 - 80000	100	166	58	48	80	-9 - 36	MGN4S

1. BIG-PLUS® tools can be used in machining centers with non BIG-PLUS® spindles.
2. Exclusive Stop Block is required.
3. Nut and wrench are included.
4. Collet (NBC4S-_) and XF1 (air unit) are to be ordered separately.
5. „CP” indicates compression.

Accessories & Spare Parts

<p>MEGA Nuts</p> <p>▶ 326</p>	<p>Micro Collets</p> <p>▶ 324</p>	<p>MEGA Wrenches</p> <p>▶ 351</p>	<p>Semi-Finished Stop Blocks</p> <p>▶ 377</p>	<p>Air Filter Regulator for RBX</p> <p>▶ 366</p>
-------------------------------	-----------------------------------	-----------------------------------	---	--

Air Turbine Spindle Manual Type

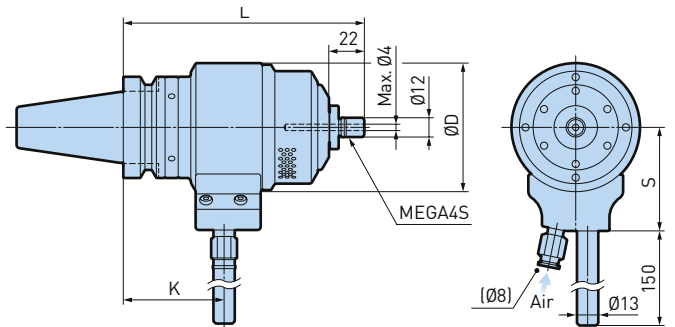

A.1

ø0.5 - 4mm

Model	Order No.	Operation Speed (min-1)	ØD	L	K	S	Nut Model
BBT30-RBX7-4S-152H	802.396	60000 - 80000	80	152	64.5	65	MGN4S
BBT40-RBX5-4S-151H	802.399	40000 - 50000	96	151	63	71	MGN4S
BBT40-RBX7-4S-151H	802.405	60000 - 80000	80	151	63	65	MGN4S
BBT50-RBX5-4S-166H	802.412	40000 - 50000	100	166	78	80	MGN4S
BBT50-RBX7-4S-166H	802.417	60000 - 80000	100	166	78	80	MGN4S

1. BIG-PLUS® tools can be used in machining centers with non BIG-PLUS® spindles.
2. Nut and wrench are included.
3. Collet (NBC4S-_) and XF1 (air unit) are to be ordered separately.

Accessories & Spare Parts

<p>MEGA Nuts</p> <p>▶ 326</p>	<p>Micro Collets</p> <p>▶ 324</p>	<p>MEGA Wrenches</p> <p>▶ 351</p>	<p>Air Filter Regulator for RBX</p> <p>▶ 366</p>
--------------------------------------	--	--	---

Application Examples

RBX7

Aluminium A2017

Outstanding runout accuracy permits perfect thin wall cutting.

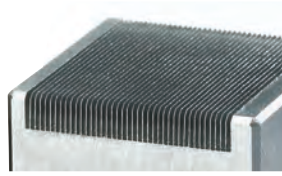
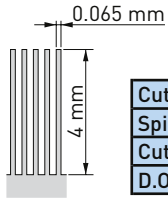

Cutter	Ø 0.5 mm Rib-endmill
Spindle Speed	70 000 min ⁻¹
Cutting Feed	1 500 mm/min
D.O.C	ap = 0.02 mm

Prehardened steel HRC40

Drastic time reduction by ultra high speed rotation. Excellent dynamic runout accuracy makes DOC of 5 µm clearly visible.

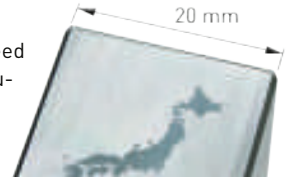

Cutter	R0.1 mm Ball nose endmill
Spindle Speed	80 000 min ⁻¹
Cutting Feed	400 mm/min
D.O.C	ap = 0.01 mm

Prehardened steel HRC40

Overall cutting length of 656 m can be achieved with one ball nose endmill. Drastically extended tool life.



Cutter	R0.5 mm Ball nose endmill
Spindle Speed	65 000 min ⁻¹
Cutting Feed	4 200 mm/min
D.O.C	ap = 0.02 mm; ae = 0.05 mm

Prehardened steel HRC40

Original 5hour operation in MC is reduced to 2 hours.

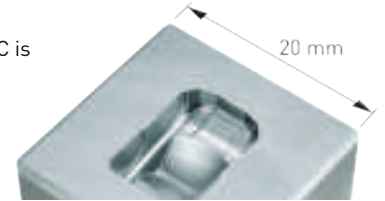

Cutter	R0.2 mm Ball nose endmill
Spindle Speed	70 000 min ⁻¹
Cutting Feed	1 000 mm/min
D.O.C	ap = 0.01 mm

Prehardened steel HRC40

No thermal expansion of spindle results in finely detailed surface finish.

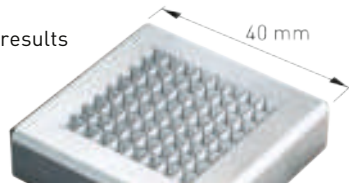

Cutter	R0.5 mm Ball nose endmill
Spindle Speed	75 000 min ⁻¹
Cutting Feed	400 mm/min
D.O.C	ap = 0.02 mm

Aluminium A2017

High-precision drilling is possible without center drill operation. Even after 3500 holes, no problems can be found on the cutting edge.

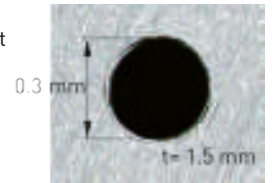

Cutter	Ø 0.3 mm Solid drill
Spindle Speed	75 000 min ⁻¹
Cutting Feed	200 mm/min
Peck	ap = 0.03 mm

RBX5

Prehardened steel HRC40

Even a taper endmill that has high cutting forces can achieve stable cutting.

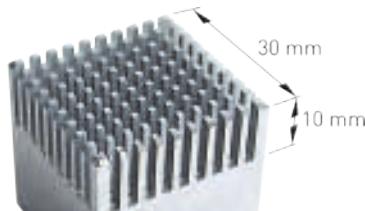

Cutter	Ø 1.5 mm Rib-endmill
Spindle Speed	40 000 min ⁻¹
Cutting Feed	1 000 mm/min
D.O.C	ap = 0.05 mm

Stainless steel SUS303

Tool life is doubled with over 1200 holes and cutting time is reduced to 1/3.

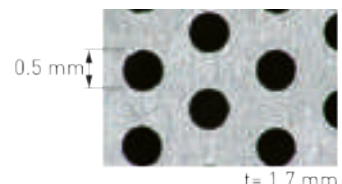

Cutter	Ø 0.5 mm Solid drill
Spindle Speed	40 000 min ⁻¹
Cutting Feed	20 mm/min
Peck	ap = 0.01 mm

Tool Holders DV/BDV, DIN 69871

MEGA Micro Chuck	128
MEGA New Baby Chuck	129
MEGA E Chuck	131
MEGA Double Power Chuck	132
MEGA Perfect Grip	133
New Baby Chuck	134
New Hi-Power Milling Chuck	136
Hydraulic Chucks	138
Shrink Chuck	141
CK Shanks	142
Face Mill Arbors	146
Smart Damper Face Mill	148
Side Lock Holders	150
Holdings for Screw-On Cutter	151
MEGA Synchro Tapping Holder	152
Angle Heads	153
Air Turbine Spindle	159



MEGA Micro Chuck Type T

Tapered and slim design, minimal interference combined with maximized rigidity.

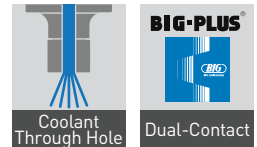

A.2

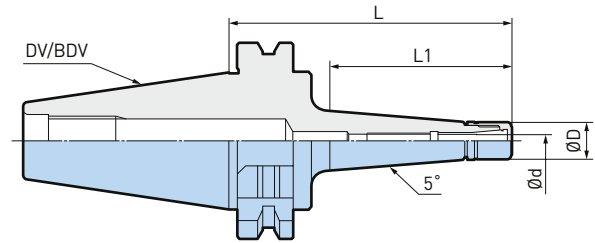

Ø0.45 - 8.05mm

Model	Order No.	Ød	ØD	L	L1	max. min-1	Collet Model	Nut Model
DV30-MEGA6S-60T	805.016	0.45 - 6.05	14	60	36	40000	NBC6S	MGN6S
DV30-MEGA8S-75T	805.246	2.95 - 8.05	18	75	51	35000	NBC8S	MGN8S
BDV40-MEGA3S-90T	969.302	0.45 - 3.25	10	90	60	28000	NBC3S	MGN3S
BDV40-MEGA4S-90T	969.305	0.45 - 4.05	12	90	60	28000	NBC4S	MGN4S
BDV40-MEGA6S-60T	969.307	0.45 - 6.05	14	60	30	35000	NBC6S	MGN6S
BDV40-MEGA6S-90T	969.308	• 0.45 - 6.05	14	90	60	28000	NBC6S	MGN6S
BDV40-MEGA6S-120T	969.309	• 0.45 - 6.05	14	120	90	22000	NBC6S	MGN6S
BDV40-MEGA8S-90T	806.747	2.95 - 8.05	18	90	60	28000	NBC8S	MGN8S

1. BIG-PLUS® tools can be used in machining centers with non BIG-PLUS® spindles.
2. MEGA nut is included in delivery.

MEGA Micro Chuck Type S

Micro diameter design is ideal for high speed applications in tight areas.

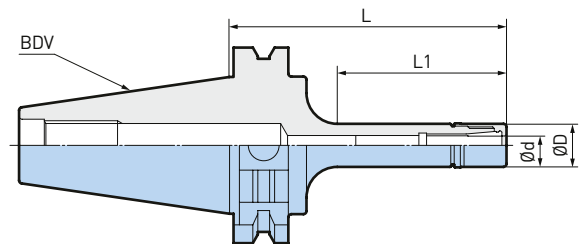
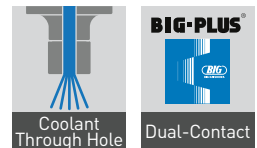

Ø0.45 - 6.05mm

Model	Order No.	Ød	ØD	L	L1	max. min-1	Collet Model	Nut Model
BDV40-MEGA6S-90	969.208	0.45 - 6.05	14	90	55	35000	NBC6S	MGN6S

1. BIG-PLUS® tools can be used in machining centers with non BIG-PLUS® spindles.
2. MEGA nut is included in delivery.

Accessories & Spare Parts

<p>MEGA Nuts</p> <p>▶ 326</p>	<p>Micro Seal Nuts</p> <p>▶ 326</p>	<p>Micro Collets</p> <p>▶ 324</p>	<p>MEGA Wrenches</p> <p>▶ 351</p>	<p>Taper Cleaners</p> <p>▶ 370</p>	<p>Collet Protective Cases</p> <p>▶ 326</p>
--------------------------------------	--	--	--	---	--

MEGA New Baby Chuck

Ideal ultra precision collet holders for high speed machining. Wide range of lengths and a variety of collet series covers all machining applications.

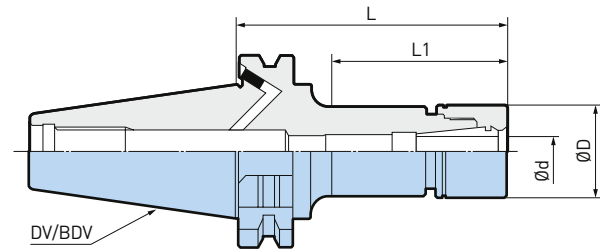
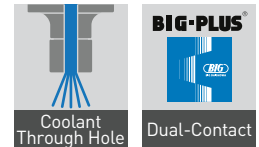

A.2

Ø0.25 - 25.4mm

Model	Order No.	Ød	ØD	L	L1	max. min-1	Collet Model	Nut Model
DV30-MEGA10N-75	805.247	1.5 - 10	30	75	54	27000	NBC10	MGN10
BDV40-MEGA6N-90	969.224	0.25 - 6	20	90	55	35000	NBC6	MGN6
BDV40-MEGA6N-135	969.225	0.25 - 6	20	135	100	20000	NBC6	MGN6
BDV40-MEGA8N-90	969.229	0.5 - 8	25	90	57	35000	NBC8	MGN8
BDV40-MEGA8N-135	969.230	0.5 - 8	25	135	102	20000	NBC8	MGN8
BDV40-MEGA10N-90	969.234	1.5 - 10	30	90	59	35000	NBC10	MGN10
BDV40-MEGA10N-135	969.235	1.5 - 10	30	135	104	20000	NBC10	MGN10
BDV40-MEGA13N-90	969.239	2.5 - 13	35	90	61	35000	NBC13	MGN13
BDV40-MEGA13N-135	969.240	2.5 - 13	35	135	106	20000	NBC13	MGN13
BDV40-MEGA13N-165	969.241	2.5 - 13	35	165	136	15000	NBC13	MGN13
BDV40-MEGA16N-90	969.244	2.5 - 16	42	90	65	30000	NBC16	MGN16
BDV40-MEGA16N-135	969.245	2.5 - 16	42	135	110	20000	NBC16	MGN16
BDV40-MEGA16N-165	969.246	2.5 - 16	42	165	140	15000	NBC16	MGN16
BDV40-MEGA20N-60	969.248	2.5 - 20	46	60	40	30000	NBC20	MGN20
BDV40-MEGA20N-90	969.249	2.5 - 20	46	90	70	30000	NBC20	MGN20
BDV40-MEGA20N-135	969.250	2.5 - 20	46	135	115	20000	NBC20	MGN20
BDV40-MEGA20N-165	969.251	2.5 - 20	46	165	145	15000	NBC20	MGN20
BDV40-MEGA20N-200	969.252	2.5 - 20	46	200	180	10000	NBC20	MGN20
BDV40-MEGA25N-90	806.375	15.5 - 25.4	60	90	70	19000	NBC25	MGN25
BDV40-MEGA25N-120	806.376	15.5 - 25.4	60	120	100	16000	NBC25	MGN25

continues on the next page



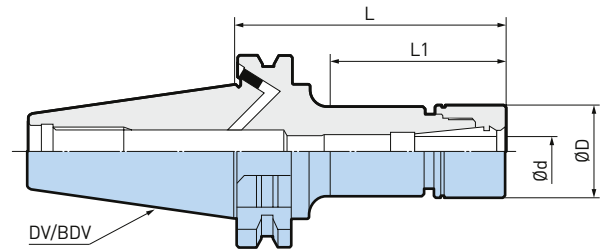

Ø0.25 - 25.4mm

Model	Order No.	Ød	ØD	L	L1	max. min-1	Collet Model	Nut Model
BDV50-MEGA6N-90	969.253	0.25 - 6	20	90	50	20000	NBC6	MGN6
BDV50-MEGA6N-120	969.254	0.25 - 6	20	120	80	20000	NBC6	MGN6
BDV50-MEGA6N-165	969.255	0.25 - 6	20	165	125	14000	NBC6	MGN6
BDV50-MEGA10N-90	969.261	1.5 - 10	30	90	55	20000	NBC10	MGN10
BDV50-MEGA10N-120	969.262	1.5 - 10	30	120	80	20000	NBC10	MGN10
BDV50-MEGA10N-165	969.263	1.5 - 10	30	165	125	16000	NBC10	MGN10
BDV50-MEGA13N-90	969.267	2.5 - 13	35	90	55	18000	NBC13	MGN13
BDV50-MEGA13N-120	969.268	2.5 - 13	35	120	80	18000	NBC13	MGN13
BDV50-MEGA13N-165	969.269	2.5 - 13	35	165	125	16000	NBC13	MGN13
BDV50-MEGA16N-90	969.274	2.5 - 16	42	90	55	17000	NBC16	MGN16
BDV50-MEGA16N-120	969.275	2.5 - 16	42	120	85	17000	NBC16	MGN16
BDV50-MEGA16N-165	969.276	2.5 - 16	42	165	130	16000	NBC16	MGN16
BDV50-MEGA16N-200	969.277	2.5 - 16	42	200	165	13000	NBC16	MGN16
BDV50-MEGA20N-90	969.280	2.5 - 20	46	90	55	16000	NBC20	MGN20
BDV50-MEGA20N-120	969.281	2.5 - 20	46	120	85	16000	NBC20	MGN20
BDV50-MEGA20N-165	969.282	2.5 - 20	46	165	130	15000	NBC20	MGN20
BDV50-MEGA20N-200	969.283	2.5 - 20	46	200	165	13000	NBC20	MGN20
BDV50-MEGA25N-105	806.377	15.5 - 25.4	60	105	77	16000	NBC25	MGN25
BDV50-MEGA25N-135	806.378	15.5 - 25.4	60	135	107	15000	NBC25	MGN25

1. BIG-PLUS® tools can be used in machining centers with non BIG-PLUS® spindles.
2. MEGA nut is included in delivery.

Accessories & Spare Parts

MEGA Nuts  ▶ 334	MEGA Perfect Seals  ▶ 336	New Baby Collets  ▶ 327	MEGA Wrenches  ▶ 351	Adjusting Screws NBA  ▶ 335	Taper Cleaners  ▶ 370
--	---	---	--	---	---

MEGA E Chuck

Collet chuck designed exclusively for endmilling with high concentricity and rigidity.

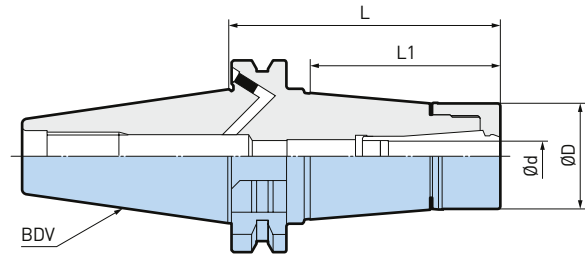
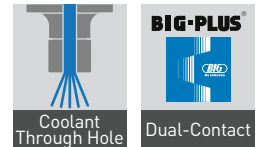

A.2

ø3 - 12mm

Model	Order No.	Ød	ØD	L	L1	max. min-1	Collet Model	Nut Model
BDV40-MEGA6E-90	968.142	3 - 6	25	90	60	30000	MEC6	MEN6
BDV40-MEGA8E-60	968.144	3 - 8	30	60	30	30000	MEC8	MEN8
BDV40-MEGA8E-90	968.145	3 - 8	30	90	63	30000	MEC8	MEN8
BDV40-MEGA10E-60	968.147	3 - 10	35	60	33	30000	MEC10	MEN10
BDV40-MEGA10E-90	968.148	3 - 10	35	90	64	30000	MEC10	MEN10
BDV40-MEGA13E-60	968.150	3 - 12	42	60	35	30000	MEC13	MEN13
BDV40-MEGA13E-90	968.151	3 - 12	42	90	61	30000	MEC13	MEN13
BDV40-MEGA13E-120	968.152	• 3 - 12	42	120	95	29000	MEC13	MEN13
BDV50-MEGA6E-120	968.154	3 - 6	25	120	90	20000	MEC6	MEN6
BDV50-MEGA8E-120	968.156	3 - 8	30	120	90	20000	MEC8	MEN8
BDV50-MEGA10E-120	968.159	3 - 10	35	120	90	20000	MEC10	MEN10
BDV50-MEGA13E-90	968.161	3 - 12	42	90	60	18000	MEC13	MEN13
BDV50-MEGA13E-120	968.162	3 - 12	42	120	90	18000	MEC13	MEN13
BDV50-MEGA13E-165	968.163	• 3 - 12	42	165	137	16000	MEC13	MEN13

1. BIG-PLUS® tools can be used in machining centers with non BIG-PLUS® spindles.
2. MEGA E nut is included.

Accessories & Spare Parts

<p>MEGA E Nuts</p> <p>▶ 340</p>	<p>MEGA E Perfect Seals</p> <p>▶ 341</p>	<p>MEGA E Collets</p> <p>▶ 340</p>	<p>MEGA Wrenches</p> <p>▶ 351</p>	<p>Adjusting Screws NBA</p> <p>▶ 335</p>	<p>Taper Cleaners</p> <p>▶ 370</p>
--	---	---	--	---	---

MEGA Double Power Chuck Type DS

Flange contacting nut assures highest rigidity. Unique coolant supply design ensures efficient coolant supply to the cutting tool periphery

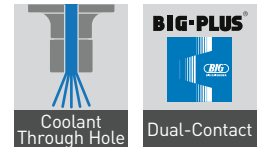

A.2

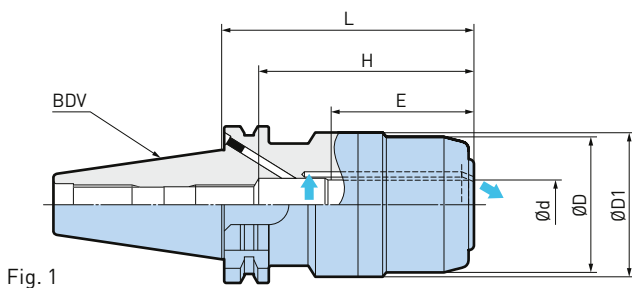

Fig. 1

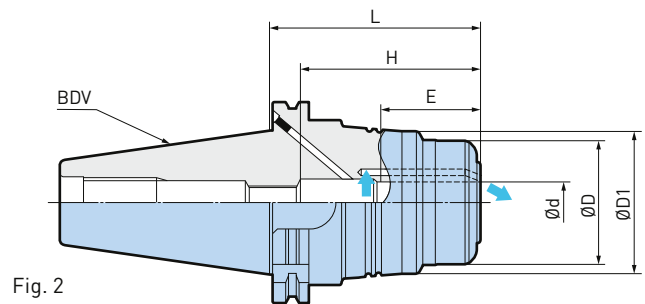

Fig. 2

Ø3 - 42mm

Model	Order No.	Fig.	Ød	ØD	ØD1	L	H	E	max. min-1
BDV40-MEGA16DS-90A *	803.075	1	16	42	52.6	92	73	50	25000
BDV40-MEGA20DS-100A	803.076	1	20	50	55	102	71 - 81	52	22000
BDV40-MEGA20DS-135A	805.596	1	20	50	55	137	71 - 81	52	20000
BDV40-MEGA25DS-100A	803.077	1	25	62	62.7	102	73 - 83	58	18000
BDV40-MEGA25DS-135A	805.597	1	25	62	62.7	137	73 - 83	58	16000
BDV40-MEGA32DS-100A	803.078	1	32	70	70.7	102	78 - 88	62	12000
BDV40-MEGA32DS-135A	805.598	1	32	70	70.7	137	78 - 88	62	10000
BDV50-MEGA16DS-70 *	969.023	2	16	46	55	72.5	73	50	20000
BDV50-MEGA20DS-100	969.025	2	20	60	69	102.5	71 - 81	52	20000
BDV50-MEGA20DS-135	805.753	2	20	60	69	137.5	71 - 81	52	19000
BDV50-MEGA25DS-105	968.059	2	25	70	77	107.5	78 - 88	58	18000
BDV50-MEGA25DS-135	805.600	2	25	70	77	137.5	78 - 88	58	17000
BDV50-MEGA32DS-105	968.060	2	32	80	86	107.5	80 - 97	62	15000
BDV50-MEGA32DS-135	805.601	2	32	80	86	137.5	80 - 97	62	13000
BDV50-MEGA42DS-105	968.061	1	42	99	99.7	107	90 - 107	62	12000

1. BIG-PLUS® tools can be used in machining centers with non BIG-PLUS® spindles.
2. Wrench and axial adjusting screw are to be ordered separately.
3. "H" is the max. tool shank length that can be inserted for these models.
4. "E" is the min. clamping length.
5. * Adjusting screw cannot be used.

Accessories & Spare Parts

PJC Collets	PSC Collets	C Collets	OCA Collets	MEGA Wrenches	Adjusting Screws HMA
					
▶ 347	▶ 348	▶ 349	▶ 348	▶ 351	▶ 350

MEGA Perfect Grip

100% security against pulling out of the cutting tool under any torque load.

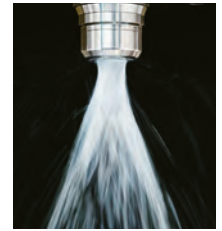
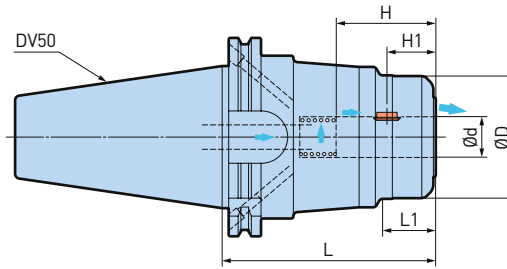

A.2

Ø20 - 32mm

Model	Order No.	Ød	ØD	L	L1	H	H1
DV50-MEGA20DPG-105ADF	805.808	20	60	105	27	49	24
DV50-MEGA25DPG-105ADF	805.809	25	70	105	33	55	23
DV50-MEGA32DPG-105ADF	805.810	32	80	105	41	59	23

1. Key grip and spring are included with each holder.
2. MEGA wrench is to be ordered separately.
3. „H1“ shows distance from center of key grip to front end.

Weldon Shank Standards

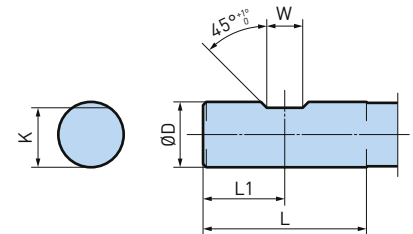
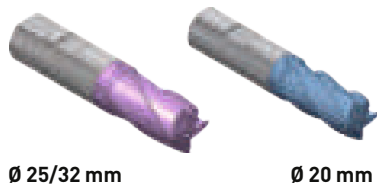

(DIN 1835-1)

The following standard shank is required for MEGA Perfect Grip.

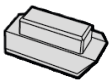

ØD		L	L1	W	K		
Nominal	Tolerance					Nominal	Tolerance
20	h6	50	25	11	+ 0.05 0	18.2	h13
25						23	
32						30	

Accessories & Spare Parts

<p>Key Grip MEGA Perfect Grip</p>  <p>▶ 350</p>	<p>Spring MEGA Perfect Grip</p>  <p>▶ 350</p>	<p>MEGA Wrenches</p>  <p>▶ 351</p>
--	--	---

New Baby Chuck

The original high precision collet chuck to perform all machining applications.



A.2

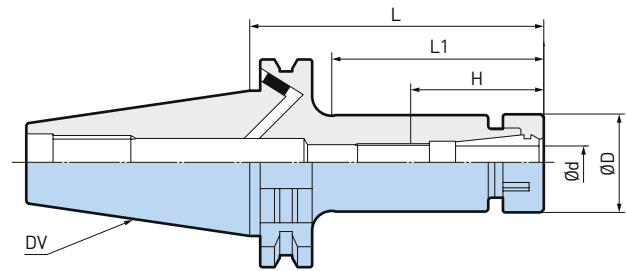

ø0.25 - 20mm

Model	Order No.	Ød	ØD	L	L1	H	Collet Model	Nut Model
DV40-NBS6-60	961.831	0.25 - 6	20	60	34	20 - 40	NBC6	NBN6
DV40-NBS6-90	969.032	0.25 - 6	20	90	60	20 - 40	NBC6	NBN6
DV40-NBS6-135	961.833	0.25 - 6	20	135	105	20 - 40	NBC6	NBN6
DV40-NBS8-60	969.034	0.5 - 8	25	60	34	23 - 42	NBC8	NBN8
DV40-NBS8-90	961.835	0.5 - 8	25	90	62	23 - 42	NBC8	NBN8
DV40-NBS8-135	969.036	0.5 - 8	25	135	107	23 - 42	NBC8	NBN8
DV40-NBS10-60	969.037	1.5 - 10	30	60	34	35 - 45	NBC10	NBN10
DV40-NBS10-90	969.038	1.5 - 10	30	90	64	35 - 45	NBC10	NBN10
DV40-NBS10-135	961.839	1.5 - 10	30	135	104	35 - 45	NBC10	NBN10
DV40-NBS13-60	969.040	2.5 - 13	35	60	37	41 - 60	NBC13	NBN13
DV40-NBS13-90	969.041	2.5 - 13	35	90	66	41 - 60	NBC13	NBN13
DV40-NBS13-135	969.042	2.5 - 13	35	135	106	41 - 60	NBC13	NBN13
DV40-NBS16-60	969.043	2.5 - 16	42	60	38	45 - 65	NBC16	NBN16
DV40-NBS16-90	969.044	2.5 - 16	42	90	68	45 - 65	NBC16	NBN16
DV40-NBS16-135	969.045	2.5 - 16	42	135	113	45 - 65	NBC16	NBN16
DV40-NBS20-60	969.046	2.5 - 20	46	60	40	48 - 65	NBC20	NBN20
DV40-NBS20-90	969.047	2.5 - 20	46	90	70	48 - 65	NBC20	NBN20
DV40-NBS20-135	969.048	2.5 - 20	46	135	115	48 - 65	NBC20	NBN20
DV40-NBS20-165	969.059	2.5 - 20	46	165	145	48 - 65	NBC20	NBN20
DV40-NBS20-200	969.060	2.5 - 20	46	200	180	48 - 65	NBC20	NBN20

Model	Order No.	Ød	ØD	L	L1	H	Collet Model	Nut Model
DV50-NBS6-120	969.062	0.25 - 6	20	120	85	20 - 40	NBC6	NBN6
DV50-NBS6-165	969.063	0.25 - 6	20	165	125	20 - 40	NBC6	NBN6
DV50-NBS8-120	969.066	0.5 - 8	25	120	80	23 - 42	NBC8	NBN8
DV50-NBS8-165	969.067	0.5 - 8	25	165	130	23 - 42	NBC8	NBN8
DV50-NBS10-90	969.069	1.5 - 10	30	90	60	35 - 45	NBC10	NBN10
DV50-NBS10-120	969.070	1.5 - 10	30	120	85	35 - 45	NBC10	NBN10
DV50-NBS10-165	969.071	1.5 - 10	30	165	130	35 - 45	NBC10	NBN10
DV50-NBS13-90	969.075	2.5 - 13	35	90	60	41 - 60	NBC13	NBN13
DV50-NBS13-120	961.876	2.5 - 13	35	120	80	41 - 60	NBC13	NBN13
DV50-NBS13-165	969.077	2.5 - 13	35	165	125	41 - 60	NBC13	NBN13
DV50-NBS16-90	969.082	2.5 - 16	42	90	60	45 - 65	NBC16	NBN16
DV50-NBS16-120	969.083	2.5 - 16	42	120	85	45 - 65	NBC16	NBN16
DV50-NBS16-165	969.084	2.5 - 16	42	165	130	45 - 65	NBC16	NBN16
DV50-NBS16-200	969.085	2.5 - 16	42	200	165	45 - 65	NBC16	NBN16
DV50-NBS20-75	969.087	2.5 - 20	46	75	45	45	NBC20	NBN20
DV50-NBS20-90	969.088	2.5 - 20	46	90	60	45	NBC20	NBN20
DV50-NBS20-120	961.889	2.5 - 20	46	120	85	45	NBC20	NBN20
DV50-NBS20-165	969.090	2.5 - 20	46	165	130	45	NBC20	NBN20
DV50-NBS20-200	969.091	2.5 - 20	46	200	165	45	NBC20	NBN20

1. New Baby Nut is included.
2. "H" is the max. tool shank length that can be inserted for these models.

Accessories & Spare Parts

<p>New Baby Nuts</p>  <p>▶ 334</p>	<p>Baby Perfect Seals</p>  <p>▶ 338</p>	<p>New Baby Collets</p>  <p>▶ 327</p>	<p>New Baby Wrenches</p>  <p>▶ 352</p>	<p>Adjusting Screws NBA</p>  <p>▶ 335</p>	<p>Tap Driving Back Stops</p>  <p>▶ 335</p>	<p>Taper Cleaners</p>  <p>▶ 370</p>
--	---	---	--	--	---	---

New Hi-Power Milling Chuck Type S

The original design assures heavy machining with high power and precision.

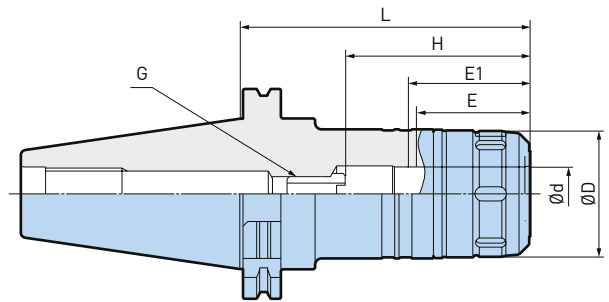
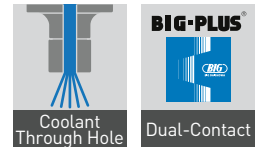







ø3 - 42mm

Model	Order No.	Ød	ØD	L	H	E	E1
BDV40-HMC20S-85	962.121S	20	50	85	69 - 79	50	56
BDV40-HMC20S-105	800.972	20	50	105	69 - 79	50	56
BDV40-HMC20S-120	800.973	20	50	120	69 - 79	50	56
BDV40-HMC25S-95	800.975	25	59	95	71 - 81	56	57
BDV40-HMC25S-105	800.974	25	59	105	71 - 81	56	57
BDV40-HMC32S-95	962.124S	32	68	95	79 - 89	60	64
BDV40-HMC32S-105	800.976	32	68	105	79 - 89	60	64
BDV40-HMC32S-135	800.977	32	68	135	79 - 89	60	64
BDV50-HMC20S-105	805.430	20	50	105	69 - 79	50	56
BDV50-HMC20S-135	805.431	20	50	135	69 - 79	50	56
BDV50-HMC25S-105	805.424	25	59	105	76 - 86	56	57
BDV50-HMC25S-135	805.433	25	59	135	76 - 86	56	57
BDV50-HMC32S-105	804.995	32	68	105	88 - 98	60	72
BDV50-HMC32S-135	805.435	32	68	135	88 - 98	60	72
BDV50-HMC32S-165	805.436	32	68	165	88 - 98	60	72
BDV50-HMC42S-135	805.438	42	85	135	93 - 105	70	73

1. BIG-PLUS® tools can be used in machining centers with non BIG-PLUS® spindles.
2. Wrench and axial adjusting screw are to be ordered separately.
3. "E" is the min. clamping length.
4. "G" is the adjusting screw (optional).
5. "H" is the max. tool shank length that can be inserted for these models.
6. "E1" is the min. clamping length for optimum use with center through coolant.
7. Standard DV models (without BIG-PLUS) are also available. Please contact BIG KAISER for details.

Accessories & Spare Parts

PJC Collets	OCA Collets	PSC Collets	C Collets	FK Wrenches	Adjusting Screws HMA
					
▶ 347	▶ 348	▶ 348	▶ 349	▶ 352	▶ 350

New Hi-Power Milling Chuck Type HMC12J

Extremely slim and rigid design with jet through coolant.

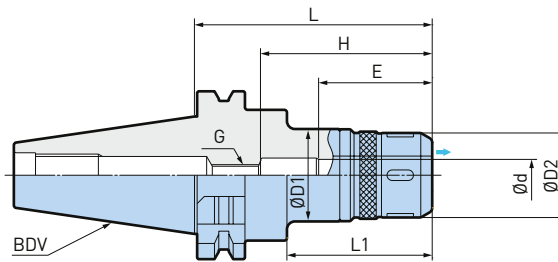
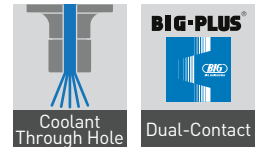



A.2

ø6 - 12mm

Model	Order No.	Ød	ØD1	ØD2	L	L1	H	E	G
BDV40-HMC12J-90	806.810	12	35	32	90	55	65	43	M8
BDV40-HMC12J-120	806.811	12	35	32	120	70	65	43	M8
BDV50-HMC12J-105	806.812	12	35	32	105	70	65	43	M8
BDV50-HMC12J-135	806.813	12	35	32	135	70	65	43	M8

1. "E" is the min. clamping length.
2. Wrench is to be ordered separately.
3. BIG-PLUS® tools can be used in machining centers with non BIG-PLUS® spindles.
4. Standard DV models (without BIG-PLUS) are also available. Please contact BIG KAISER for details.

Accessories & Spare Parts

<p>PJC Collets</p>  <p>▶ 347</p>	<p>FK Wrenches</p>  <p>▶ 352</p>	<p>Adjusting Screws HMA</p>  <p>▶ 350</p>
---	---	--

Hydraulic Chuck Super Slim

Ultra precise hydraulic chuck with extremely slim design.

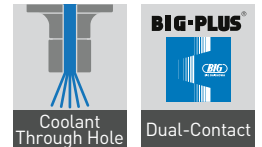

A.2

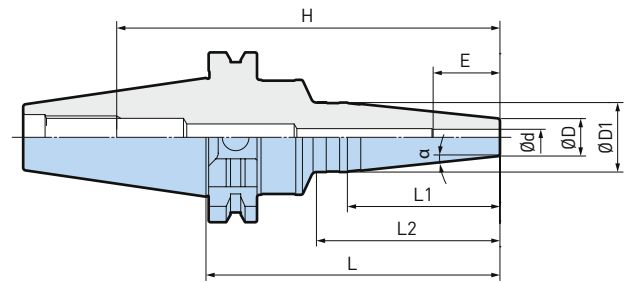

$\phi 4 - 12\text{mm}$

Model	Order No.	ϕd	ϕD	$\phi D1$	L	L1	L2	H	E	α
BDV40-HDC4S-110	806.347	4	14	26	110	57	68	145	19	6°
BDV40-HDC6S-110	806.348	6	14	26	110	57	68	145	25	6°
BDV40-HDC8S-110	806.349	8	17	28	110	52	69	145	31	6°
BDV40-HDC10S-110	806.350	10	19	30	110	52	69	145	33	6°
BDV40-HDC12S-110	806.351	12	21	32	110	52	70	145	36	6°

1. BIG-PLUS® tools can be used in machining centers with non BIG-PLUS® spindles.
2. "E" is the min. clamping length.
3. Adjusting Screw and straight collet cannot be used.
4. "H" indicates the maximum cutting tool insertion length.

Accessories & Spare Parts

Wiper Cleaners



► 370

Hydraulic Chuck Jet Through

Coolant or Minimum Quantity Lubrication is supplied to cutting edge securely. Maximum performance and high-precision with 5-axis machining.

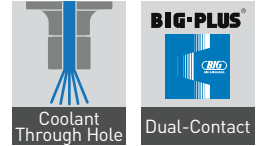

Peripheral

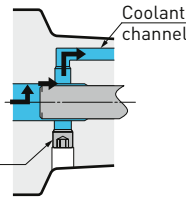

Center Through

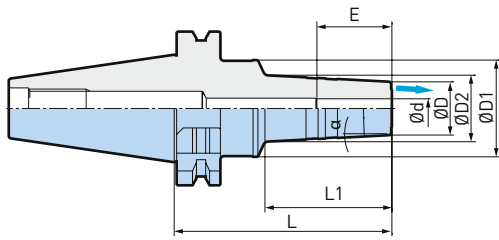
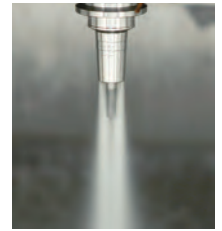
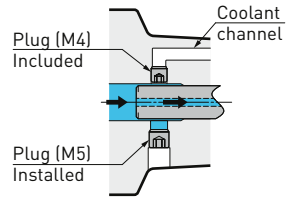

ø4 - 12mm

Model	Order No.	Ød	ØD	ØD1	ØD2	L	L1	E	α
BDV40-HDC4J-90	807.203	4	20	46	23	90	50	19	3°
BDV40-HDC6J-90	807.204	6	20	42	26	90	50	25	3°
BDV40-HDC8J-90	807.205	8	22	42	28	90	50	28	3°
BDV40-HDC10J-90	807.206	10	24	44	30	90	50	33	3°
BDV40-HDC12J-90	807.207	12	26	46	32	90	50	13	3°

1. BIG-PLUS® tools can be used in machining centers with non BIG-PLUS® spindles.
2. Adjusting screw cannot be used.
3. Straight collet cannot be used.

Caution

- Use only cutting tools that have a shank tolerance within h6.
- Roughing endmills are not recommended for use with hydraulic chucks.
- Do not use with cutting tools made with a flat on the shank. (ie: Weldon type shank)
- Do not tighten the clamping screw without first inserting a cutting tool into the hydraulic chuck.
- Always insert the cutting tool into the hydraulic chuck beyond min. clamping length E.

Accessories & Spare Parts

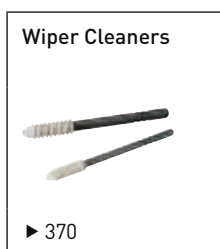

Hydraulic Chuck Standard

For high precision machining in automotive, aerospace, medical and die & mold.

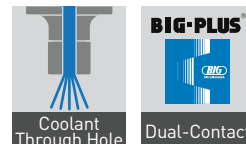

A.2

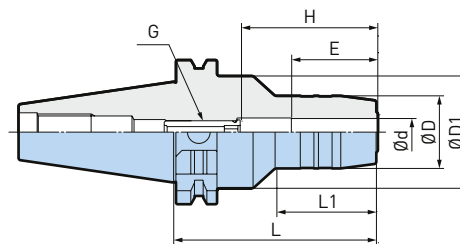

Fig. 1

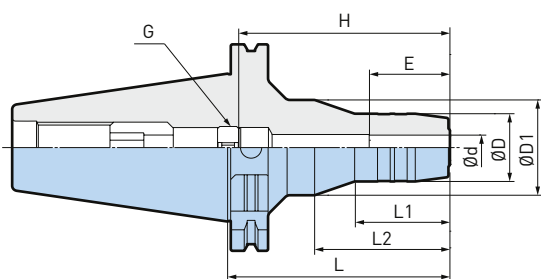

Fig. 2

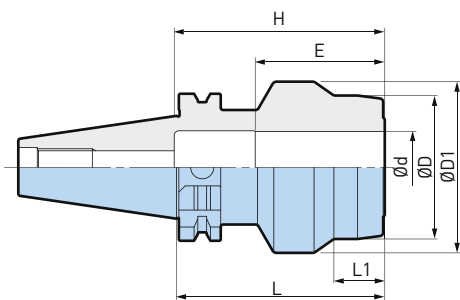

Fig. 3

ø3 - 31mm

Model	Order No.	Fig.	Ød	ØD	ØD1	L	L1	L2	H	E	G
BDV40-HDC6-90	806.352	1	6	26	49.5	90	43	-	28 - 50	28	HDA6-05032
BDV40-HDC8-90	806.353	1	8	28	49.5	90	43	-	28 - 50	28	HDA8-06032
BDV40-HDC10-90	806.354	1	10	30	49.5	90	44	-	33 - 55	33	HDA10-08032
BDV40-HDC12-90	806.355	1	12	32	49.5	90	44	-	38 - 60	38	HDA12-10032
BDV40-HDC14-90	806.356	1	14	34	49.5	90	44	-	38 - 60	38	HDA12-10032
BDV40-HDC16-90	806.357	1	16	38	49.5	90	47	-	43 - 70	43	HDA16-12037
BDV40-HDC18-90	806.358	1	18	40	49.5	90	49	-	43 - 70	43	HDA16-12037
BDV40-HDC20-90	806.359	1	20	42	49.5	90	51	-	43 - 70	43	HDA16-12037
BDV40-HDC31-90	806.441	3	31	62	74	90	22	-	91	56	-
BDV50-HDC12L-105	806.360	2	12	32	45	105	44	63	100 - 120	38	HDA6-20010
BDV50-HDC20L-105	806.361	2	20	42	50	105	46	63	71 - 111	43	HDA20-12047

1. BIG-PLUS® tools can be used in machining centers with non BIG-PLUS® spindles.
2. "E" is the min. clamping length.
3. "G" is the adjusting screw (optional).
4. "H" is the max. tool shank length that can be inserted for these models.

Accessories & Spare Parts

<p>PJC Collets</p> <p>▶ 347</p>	<p>PSC Collets</p> <p>▶ 348</p>	<p>Adjusting Screws HDA</p> <p>▶ 354</p>	<p>Wiper Cleaners</p> <p>▶ 370</p>
---------------------------------	---------------------------------	--	------------------------------------

Shrink Chuck Standard

Solid body provides higher rigidity.

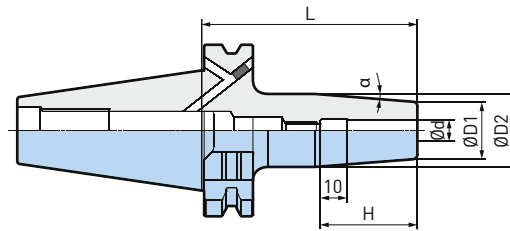
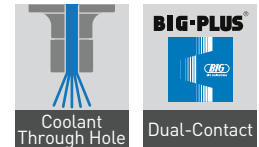

A.2

ø6 - 25mm

Model	Order No.	Ød	ØD1	ØD2	L	H	α
BDV40-SRC6D-80	490.506	6	21	27	80	36	4.5°
BDV40-SRC6D-120	490.556	6	21	27	120	36	4.5°
BDV40-SRC8D-80	490.508	8	21	27	80	36	4.5°
BDV40-SRC8D-120	490.558	8	21	27	120	36	4.5°
BDV40-SRC10D-80	490.510	10	24	32	80	42	4.5°
BDV40-SRC10D-120	490.560	10	24	32	120	42	4.5°
BDV40-SRC12D-80	490.512	12	24	32	80	47	4.5°
BDV40-SRC12D-120	490.562	12	24	32	120	47	4.5°
BDV40-SRC14D-80	490.514	14	27	34	80	47	4.5°
BDV40-SRC16D-80	490.516	16	27	34	80	50	4.5°
BDV40-SRC16D-120	490.566	16	27	34	120	50	4.5°
BDV40-SRC18D-80	490.518	18	33	42	80	50	4.5°
BDV40-SRC20D-80	490.520	20	33	42	80	52	4.5°
BDV40-SRC20D-120	490.570	20	33	42	120	52	4.5°
BDV50-SRC6D-80	490.606	6	21	27	80	36	4.5°
BDV50-SRC6D-160	490.656	6	21	38	160	36	4.5°
BDV50-SRC8D-80	490.608	8	21	27	80	36	4.5°
BDV50-SRC8D-160	490.658	8	21	38	160	36	4.5°
BDV50-SRC10D-80	490.610	10	24	32	80	42	4.5°
BDV50-SRC10D-160	490.660	10	24	41	160	42	4.5°
BDV50-SRC12D-80	490.612	12	24	32	80	47	4.5°
BDV50-SRC12D-160	490.662	12	24	41	160	47	4.5°
BDV50-SRC14D-80	490.614	14	27	34	80	47	4.5°
BDV50-SRC14D-160	490.664	14	27	44	160	47	4.5°
BDV50-SRC16D-80	490.616	16	27	34	80	50	4.5°
BDV50-SRC16D-160	490.666	16	27	44	160	50	4.5°
BDV50-SRC18D-80	490.618	18	33	42	80	50	4.5°
BDV50-SRC18D-160	490.668	18	33	50	160	50	4.5°
BDV50-SRC20D-80	490.620	20	33	42	80	52	4.5°
BDV50-SRC20D-160	490.670	20	33	50	160	52	4.5°
BDV50-SRC25D-100	490.625	25	44	53	100	58	4.5°
BDV50-SRC25D-160	490.675	25	44	61	160	58	4.5°

1. BIG-PLUS® tools can be used in machining centers with non BIG-PLUS® spindles.
2. Use carbide cutter within a tolerance of h6.
3. Please refer to the operation manual of heating / cooling equipment, as some equipment may not be compatible.

Accessories & Spare Parts

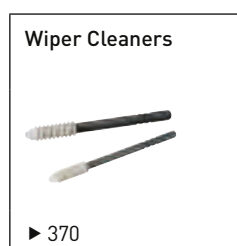

CK Shanks with Center Through Coolant

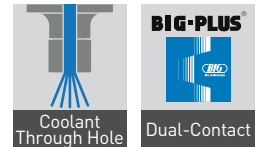

A.2

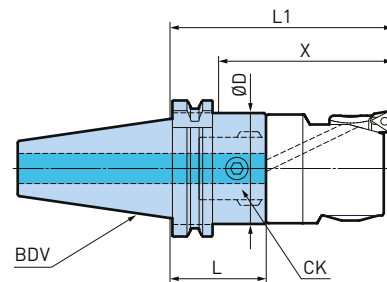

CK4 - CK7

Model	Order No.	CK	ØD	L	L1	X
BDV40-CKB4-73ADF	323.826	CKB4	39	73	120	80
BDV40-CKB5-43ADF	323.825	CKB5	50	43	100	60
BDV40-CKN6-59	323.821N	CKN6	63.5	59	130	90
BDV50-CKB5-83ADF	323.868	CKB5	50	83	140	100
BDV50-CKN6-69	323.860N	CKN6	63.5	69	140	100
BDV50-CKN6-129	323.864N	CKN6	63.5	129	200	160
BDV50-CKN6-229	323.865N	CKN6	63.5	229	300	260
BDV50-CKN7-83	323.861N	CKN7	90	83	200 (170)	160 (130)
BDV50-CKB7-133	323.862	CKB7	90	133	250 (220)	210 (180)
BDV50-CKN7-243	323.866N	CKN7	90	243	360 (330)	320 (290)

1. BIG-PLUS® tools can be used in machining centers with non BIG-PLUS® spindles.
2. X and L1 dimensions on the table are reference figures when EWN/EWE head is mounted.
3. Cutting edge and drive key grooves are located in the same orientation.
4. ADF indicates both flange through and center through coolant available.
5. () Indicate the length when short version of EWN (EWN100-203CKB7-87) is mounted.

Accessories & Spare Parts

Fine Boring Heads



▶ 396-399

Smart Damper CK Shanks

Tool shanks with integrated damping system for highly efficient deep hole fine boring.

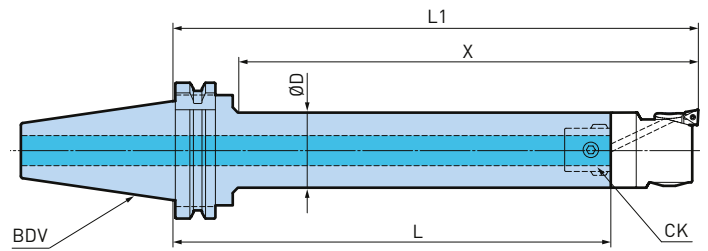

A.2

CK5 - CK6

Model	Order No.	CK	ØD	L	L1	X
BDV50-CKB5DP-301	328.233	CKB5	50	301	358	318
BDV50-CKB6DP-377	328.235	CKB6	60	377	448	408

1. BIG-PLUS® tools can be used in machining centers with non BIG-PLUS® spindles.
2. X and L1 dimensions on the table are reference figures when EWN/EWE head is mounted.
3. Cutting edge and drive key grooves are located in the same orientation.

Accessories & Spare Parts

Fine Boring Heads



► 396-399

CK Shanks with Center and Flange Through Coolant

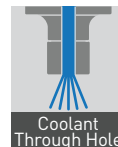

A.2

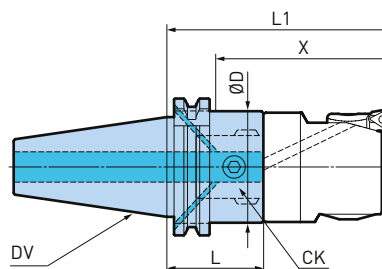

CK1 - CK7

Model	Order No.	CK	ØD	L	L1	X
DV30-CKB3-31ADF	323.701	CKB3	31	31	71	47
DV40-CKB1-91ADF	326.011	CKB1	19	90.5	123	83
DV40-CKB2-85ADF	326.021	CKB2	24	84.5	120	80
DV40-CKB3-35ADF	323.728	CKB3	31	35	75	50
DV40-CKB3-80ADF	326.031	CKB3	31	80	120	80
DV40-CKB4-73ADF	326.041	CKB4	39	73	120	80
DV40-CKB5-43ADF	326.057	CKB5	50	43	100	60
DV40-CKB5-143ADF	326.054	CKB5	50	143	200	160
DV40-CKN6-59ADF	323.726N	CKN6	63.5	59	130	90
DV40-CKB6-99ADF	323.722	CKB6	63.5	99	170	130
DV40-CKB6-129ADF	326.064	CKB6	63.5	129	200	160
DV50-CKB3-130ADF	325.933	CKB3	31	130	170	130
DV50-CKB4-93ADF	325.942	CKB4	39	93	140	100
DV50-CKB4-153ADF	325.944	CKB4	39	153	200	160
DV50-CKB5-83ADF	325.952	CKB5	50	83	140	100
DV50-CKB5-143ADF	325.954	CKB5	50	143	200	160
DV50-CKB5-183ADF	325.955	CKB5	50	183	240	200
DV50-CKN6-69ADF	323.765N	CKN6	63.5	69	140	100
DV50-CKN6-129ADF	323.767N	CKN6	63.5	129	200	160
DV50-CKB6-169ADF	325.965	CKB6	63.5	169	240	200
DV50-CKN6-229ADF	323.768N	CKN6	63.5	229	300	260
DV50-CKN7-83ADF	323.766N	CKN7	90	83	200 (170)	160 (130)
DV50-CKN7-273ADF	323.769N	CKN7	90	273	390 (360)	350 (320)

1. X and L1 dimensions on the table are reference figures when EWN/EWE head is mounted.
2. Cutting edge and drive key grooves are located in the same orientation.
3. ADF indicates both flange through and center through coolant available.
4. () Indicate the length when short version of EWN (EWN100-203CKB7-87) is mounted.

Accessories & Spare Parts

Fine Boring Heads



▶ 396-399

CK Shanks with Center Through Coolant

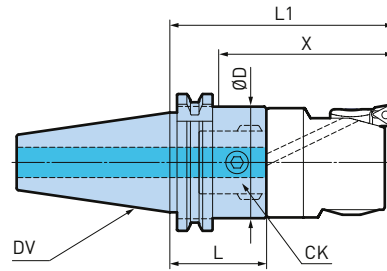

A.2

CK1, CK5-7

Model	Order No.	CK	ØD	L	L1	X
DV30-CKB1-40	323.703	CKB1	19	31.5	64	40
DV30-CKB5-50	326.005	CKB5	50	50	107	83
DV40-CKB5-43	326.050	CKB5	50	43	100	60
DV40-CKB6-59	323.721	CKB6	63.5	59	130	90
DV50-CKB6-69	323.760	CKB6	63.5	69	140	100
DV50-CKB6-129	325.964	CKB6	63.5	129	200	160
DV50-CKB7-83	323.761	CKB7	90	83	200 (170)	160 (130)

1. X and L1 dimensions on the table are reference figures when EWN/EWE head is mounted.
2. Cutting edge and drive key grooves are located in the same orientation.
3. [] Indicate the length when short version of EWN (EWN100-203CKB7-87) is mounted.

Accessories & Spare Parts

Fine Boring Heads



▶ 396-399

Face Mill Arbors Type FMH

For cutters that have a coolant bore through the face.

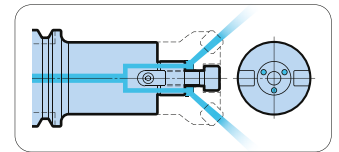
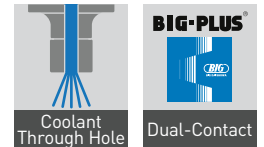

A.2



Model	Order No.	Fig.	ØD	ØD1	L	L1	L2	W	G	ØC min.
BDV40-FMH16-37-40	806.896	1	16	37	40	16	5	8	M8	28
BDV40-FMH22-47-45	805.584	1	22	47	45	18	5	10	M10	38
BDV40-FMH22-47-60	807.208	1	22	47	60	18	5	10	M10	38
BDV40-FMH22-47-90	805.585	1	22	47	90	18	5	10	M10	36
BDV40-FMH22-47-150	805.604	1	22	47	150	18	5	10	M10	36
BDV40-FMH22-60-50	805.605	2	22	60	50	18	5	10	M10	38
BDV40-FMH22-60-90	805.606	2	22	60	90	18	5	10	M10	38
BDV40-FMH27-60-50	805.586	2	27	60	50	20	6	12	M12	46
BDV40-FMH27-60-90	805.608	2	27	60	90	20	6	12	M12	46
BDV40-FMH27-76-60	805.609	2	27	76	60	20	6	12	M12	48
BDV40-FMH27-76-90	805.610	2	27	76	90	20	6	12	M12	48
BDV40-FMH32-96-60	805.611	2	32	96	60	22	7	14	M16	58

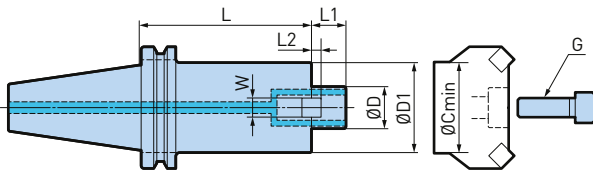

Fig. 1

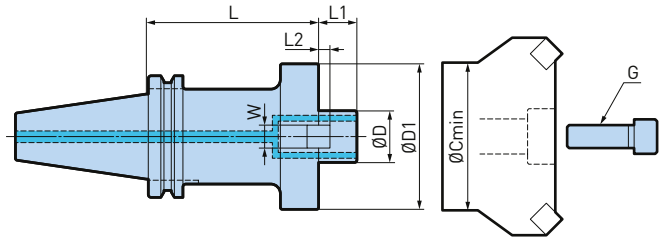
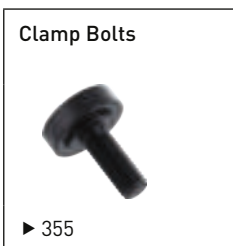

Fig. 2

Model	Order No.	Fig.	ØD	ØD1	L	L1	L2	W	G	ØC min.
BDV50-FMH16-37-105	807.209	1	16	37	105	16	5	8	M8	28
BDV50-FMH22-47-60	805.758	1	22	47	60	18	5	10	M10	38
BDV50-FMH22-47-105	805.623	1	22	47	105	18	5	10	M10	36
BDV50-FMH22-47-150	805.624	1	22	47	150	18	5	10	M10	36
BDV50-FMH22-47-200	978.226	1	22	47	200	18	5	10	M10	36
BDV50-FMH22-47-250	807.210	1	22	47	250	18	5	10	M10	36
BDV50-FMH22-60-60	805.626	1	22	60	60	18	5	10	M10	38
BDV50-FMH22-60-105	805.627	1	22	60	105	18	5	10	M10	38
BDV50-FMH22-60-150	805.628	1	22	60	150	18	5	10	M10	38
BDV50-FMH22-60-200	805.629	1	22	60	200	18	5	10	M10	38
BDV50-FMH27-60-45	805.630	1	27	60	45	20	6	12	M12	46
BDV50-FMH27-60-90	805.631	1	27	60	90	20	6	12	M12	46
BDV50-FMH27-60-150	805.632	1	27	60	150	20	6	12	M12	46
BDV50-FMH27-60-200	805.633	1	27	60	200	20	6	12	M12	46
BDV50-FMH27-76-45	805.635	1	27	76	45	20	6	12	M12	48
BDV50-FMH27-76-90	805.636	1	27	76	90	20	6	12	M12	48
BDV50-FMH27-76-150	805.637	1	27	76	150	20	6	12	M12	48
BDV50-FMH27-76-200	805.638	1	27	76	200	20	6	12	M12	48
BDV50-FMH32-96-50	805.639	2	32	96	50	22	7	14	M16	58
BDV50-FMH32-96-90	805.640	2	32	96	90	22	7	14	M16	58
BDV50-FMH32-96-150	805.641	2	32	96	150	22	7	14	M16	58
BDV50-FMH32-96-200	805.642	2	32	96	200	22	7	14	M16	58
BDV50-FMH40-100-50	805.643	2	40	100	50	26	8.5	16	M20	70
BDV50-FMH40-100-75	805.644	2	40	100	75	26	8.5	16	M20	70
BDV50-FMH40-100-105	805.645	2	40	100	105	26	8.5	16	M20	70

1. BIG-PLUS® tools can be used in machining centers with non BIG-PLUS® spindles.
2. Clamp bolt is included.
3. By using a clamping screw with a through bore, coolant is supplied through the screw

Accessories & Spare Parts



Smart Damper Basic Holders for Milling Heads

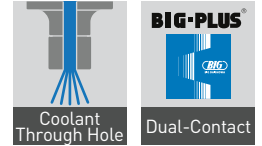

A.2

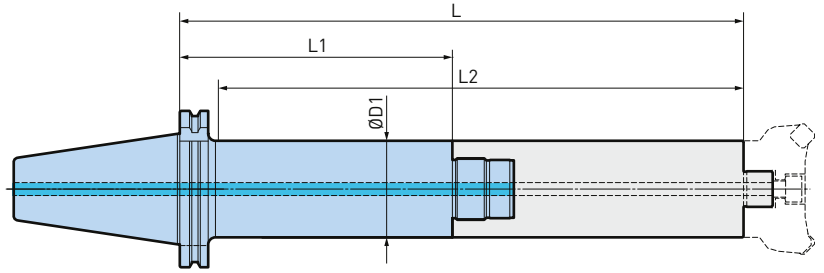

Model	Order No.	ØD1	L	L1	L2	Damper Head Model
BDV50-SDF36-47-170	805.296	47	350	170	325	FMH_DP-47
BDV50-SDF36-60-170	805.298	60	350	170	325	FMH_DP-60
BDV50-SDF36-60-220	805.299	60	400	220	375	FMH_DP-60
BDV50-SDF57-76-170	807.678	76	350	170	325	FMH_DP-76
BDV50-SDF57-76-220	807.679	76	400	220	375	FMH_DP-76

1. BIG-PLUS® tools can be used in machining centers with non BIG-PLUS® spindles.

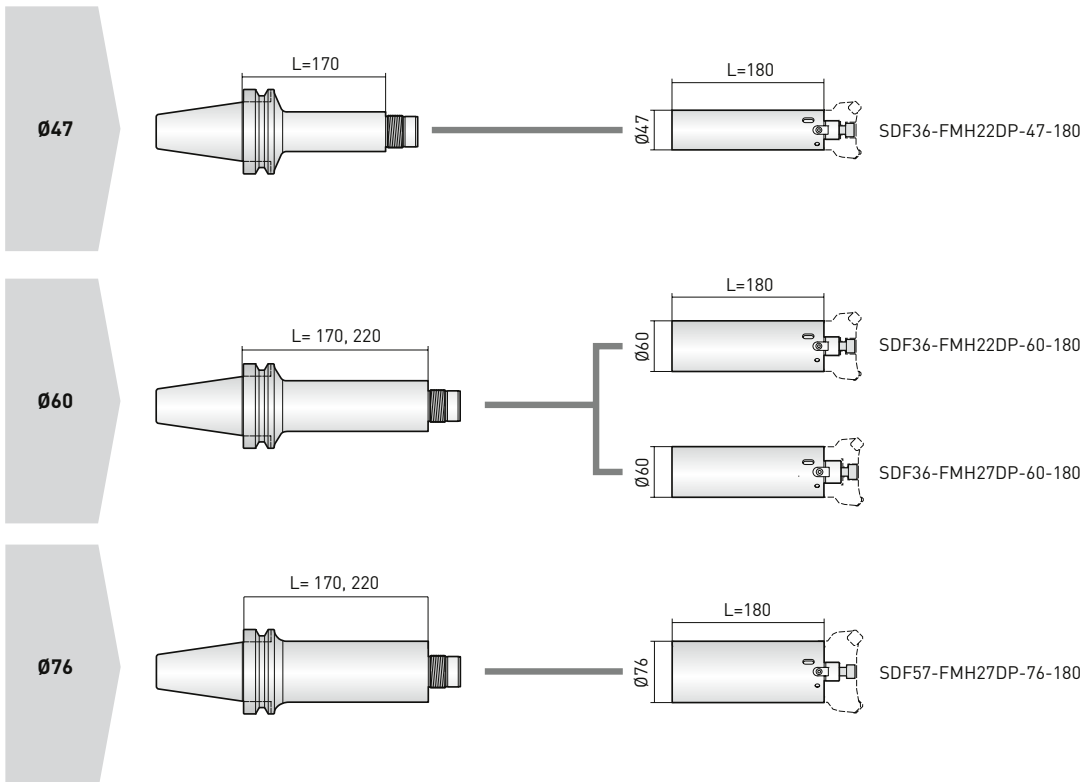

Smart Damper Damper Heads for Mills

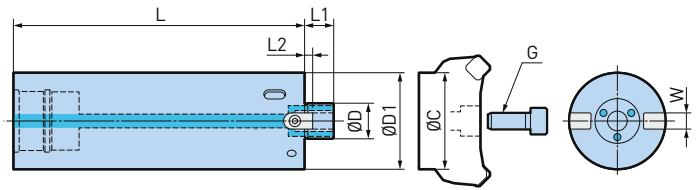
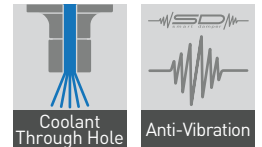

A.2

Model	Order No.	ØD	ØD1	L	L1	L2	G	W	ØC min.
SDF36-FMH22DP-47-180	804.969	22	47	180	18	5	M10	10	36
SDF36-FMH22DP-60-180	804.971	22	60	180	18	5	M10	10	38
SDF36-FMH27DP-60-180	804.972	27	60	180	20	6	M12	12	46
SDF57-FMH27DP-76-180	807.673	27	76	180	20	6	M12	12	48

1. Wrench and cutter clamping bolt are included.
2. By using a clamping screw with a through bore, coolant is supplied through the screw

Accessories & Spare Parts

FK Wrenches	Clamp Bolts
	
▶ 352	▶ 355

Side Lock Holders for Weldon

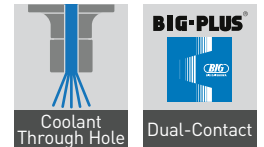

A.2

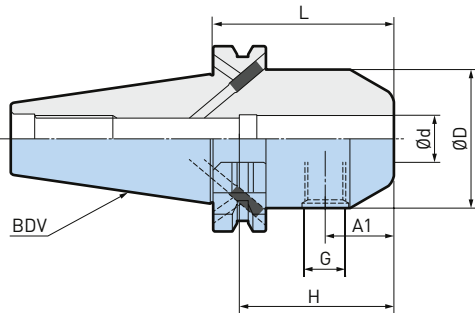

Fig. 1

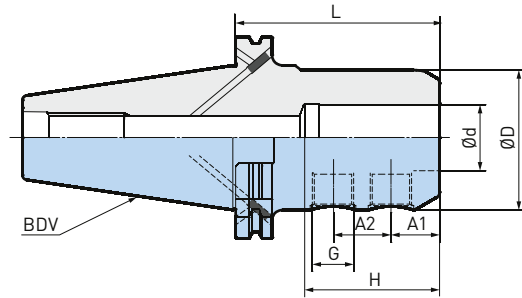

Fig. 2

ø6 - 40mm

Model	Order No.	Fig.	Ød	ØD	L	A1	A2	H	G
BDV40-ISL6-50	490.106	1	6	25	50	17.5	-	85 *	M6
BDV40-ISL8-50	490.108	1	8	28	50	17.5	-	85 *	M8
BDV40-ISL10-50	490.110	1	10	35	50	19.5	-	85 *	M10
BDV40-ISL12-50	490.112	1	12	42	50	22	-	85 *	M12
BDV40-ISL14-50	490.114	1	14	44	50	22	-	85 *	M12
BDV40-ISL16-63	490.116	1	16	48	63	23.5	-	53	M14
BDV40-ISL18-63	490.118	1	18	50	63	23.5	-	53	M14
BDV40-ISL20-63	490.120	1	20	52	63	24.5	-	55	M16
BDV40-ISL25-100	490.125	2	25	65	100	23.5	25	60	M18 P2
BDV40-ISL32-100	490.132	2	32	72	100	23.5	28	66	M20 P2
BDV50-ISL6-63	490.206	1	6	25	63	17.5	-	116 *	M6
BDV50-ISL8-63	490.208	1	8	28	63	17.5	-	116 *	M8
BDV50-ISL10-63	490.210	1	10	35	63	19.5	-	116 *	M10
BDV50-ISL12-63	490.212	1	12	42	63	22	-	116 *	M12
BDV50-ISL14-63	490.214	1	14	44	63	22	-	116 *	M12
BDV50-ISL16-63	490.216	1	16	48	63	23.5	-	116 *	M14
BDV50-ISL18-63	490.218	1	18	50	63	23.5	-	116 *	M14
BDV50-ISL20-63	490.220	1	20	52	63	24.5	-	116 *	M16
BDV50-ISL25-80	490.225	2	25	65	80	23.5	25	60	M18 P2
BDV50-ISL32-100	490.232	2	32	70	100	23.5	28	66	M20 P2
BDV50-ISL40-100	490.240	2	40	90	100	29.5	32	79	M20 P2

1. BIG-PLUS® tools can be used in machining centers with non BIG-PLUS® spindles.
2. "H" is the max. tool shank length that can be inserted for these models.
3. Use a cutting tool in accordance to DIN 1835 B / DIN 6538 HB
4. H with * indicates the maximum clamping depth to the Pull Stud Bolt.

HOLDERS for Screw-On Cutter

General metric screw-on type cutting tools can be used with these models.

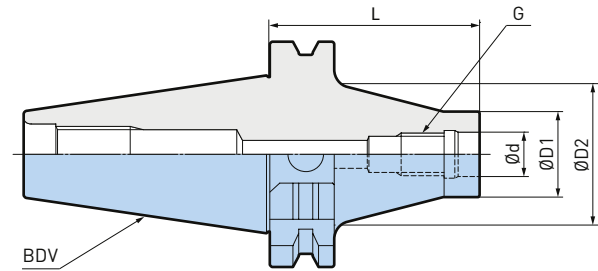
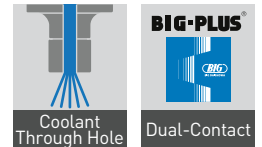

A.2

Model	Order No.	Ød	ØD1	ØD2	L	G
BDV40-M10-19-65	806.607	10.5	19	35	65	M10
BDV40-M10-19-110	807.364	10.5	19	35	110	M10
BDV40-M12-24-60	806.608	12.5	24	40	60	M12
BDV40-M12-24-105	807.365	12.5	24	40	105	M12
BDV40-M16-29-55	806.609	17	29	45	55	M16
BDV40-M16-29-100	807.366	17	29	45	100	M16

1. BIG-PLUS® tools can be used in machining centers with non BIG-PLUS® spindles.

MEGA Synchro Tapping Holder

Compensates for synchronization errors during rigid tapping. Improves thread quality and tool life by reducing thrust loads caused by synchronization errors up to 90%.

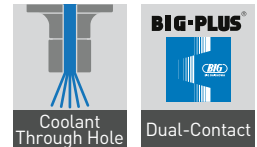

A.2

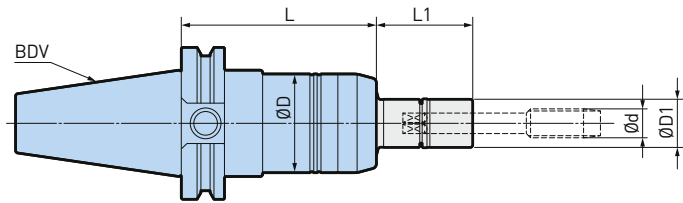

M3 - M20

Model	Order No.	Tap Holder	Ød	ØD	ØD1	L	L1
BDV40-MGT6-80	963.401	MGT6	M3-M8	36	16	80	30 - 200
BDV40-MGT12-80	963.402	MGT12	M5-M12 / P1/8	41	20	80	30 - 200
BDV40-MGT20-105	963.403	MGT20	M10-M20 / P1/4-P1/2	54	30	105	35 - 150
BDV50-MGT6-85	963.404	MGT6	M3-M8	36	16	85	30 - 200
BDV50-MGT12-85	963.405	MGT12	M5-M12 / P1/8	41	20	85	30 - 200
BDV50-MGT20-105	963.406	MGT20	M10-M20 / P1/4-P1/2	54	30	105	35 - 150

1. BIG-PLUS® tools can be used in machining centers with non BIG-PLUS® spindles.
2. Tap holder is to be ordered separately.
3. Synchronized tapping function is required on the machine.
4. Standard DV models (without BIG-PLUS) are also available. Please contact BIG KAISER for details.

MEGA Synchro Tapping Holder MGT36

For large Tapping Type MGT36

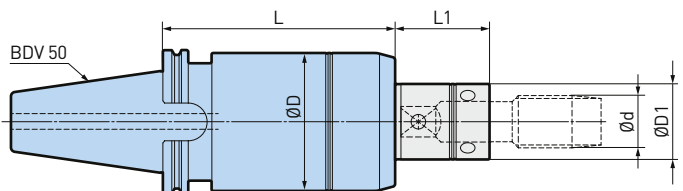
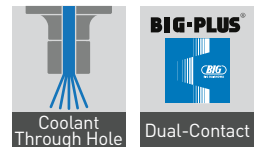

M22 - M36

Model	Order No.	Tap Holder	Ød	ØD	ØD1	L	L1
BDV50-MGT36-160	805.002	MGT36	M22-M36 / P5/8-P1	94	38-52	160	65

1. BIG-PLUS® tools can be used in machining centers with non BIG-PLUS® spindles.
2. Tap holder is to be ordered separately.
3. Synchronized tapping function is required on the machine.
4. Standard DV models (without BIG-PLUS) are also available. Please contact BIG KAISER for details.

Accessories & Spare Parts

Tap Holder	MEGA Wrenches	Accessories
<p>▶ 356-363</p>	<p>▶ 351</p>	<p>▶ 364-365</p>

New Baby Chuck Type

The Angle Head has an integrated New Baby Chuck, resulting in high precision. Available in various sizes to meet specific production requirements.

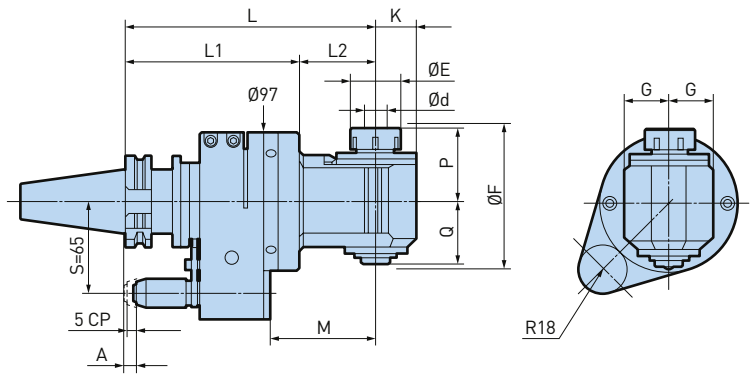

BDV40

A.2

ø0.25 - 20mm

Model	Order No.	Ød	ØE	ØF	L	L1	L2	G	K	M	P	Q	max. min-1	Collet Model
BDV40-AG90/NBS6-180	802.553	0.25 - 6	20	67	180	125	55	21	17	77	33	29	6000	NBC6
BDV40-AG90/NBS6-210	802.554	0.25 - 6	20	67	210	125	85	21	17	107	33	29	6000	NBC6
BDV40-AG90/NBS6-240	802.555	0.25 - 6	20	67	240	125	115	21	17	137	33	29	6000	NBC6
BDV40-AG90/NBS6-270	802.556	0.25 - 6	20	67	270	125	145	21	17	167	33	29	6000	NBC6
BDV40-AG90/NBS10-180	802.546	1.5 - 10	30	91	180	125	55	30	25	77	45	43	6000	NBC10
BDV40-AG90/NBS10-210	802.547	1.5 - 10	30	91	210	125	85	30	25	107	45	43	6000	NBC10
BDV40-AG90/NBS10-240	802.548	1.5 - 10	30	91	240	125	115	30	25	137	45	43	6000	NBC10
BDV40-AG90/NBS13-180	802.549	2.5 - 13	35	101	180	125	55	31	28	77	52	45	6000	NBC13
BDV40-AG90/NBS13-210	802.550	2.5 - 13	35	101	210	125	85	31	28	107	52	45	6000	NBC13
BDV40-AG90/NBS13-240	802.551	2.5 - 13	35	101	240	125	115	31	28	137	52	45	6000	NBC13
BDV40-AG90/NBS20S-175S	802.552	2.5 - 20	46	132	175	122	53	35	33	72	65	62	3000	NBC20

continues on the next page



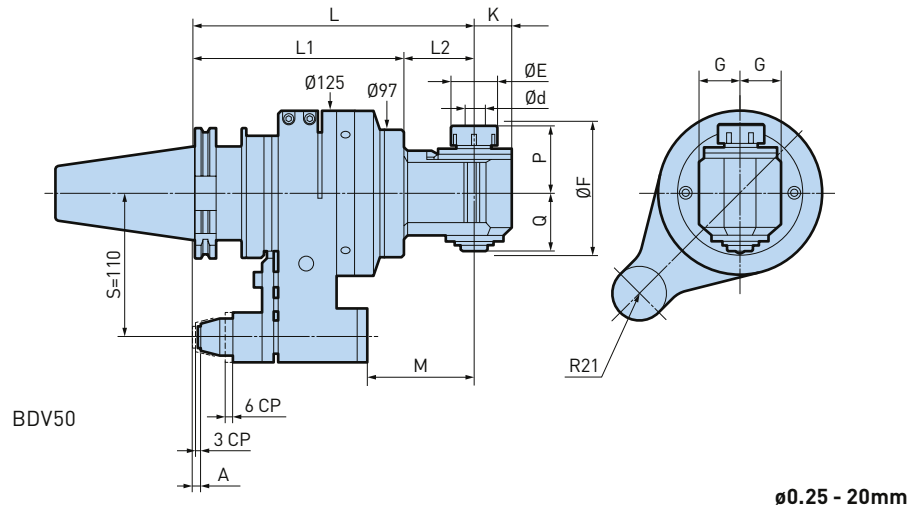



Model	Order No.	Ød	ØE	ØF	L	L1	L2	G	K	M	P	Q	max. min-1	Collet Model
BDV50-AG90/NBS6-215	802.569	0.25 - 6	20	67	215	160	55	21	17	82	33	29	6000	NBC6
BDV50-AG90/NBS6-245	802.570	0.25 - 6	20	67	245	160	85	21	17	112	33	29	6000	NBC6
BDV50-AG90/NBS6-275	802.571	0.25 - 6	20	67	275	160	115	21	17	142	33	29	6000	NBC6
BDV50-AG90/NBS6-305	802.572	0.25 - 6	20	67	305	160	145	21	17	172	33	29	6000	NBC6
BDV50-AG90/NBS10-215	802.562	1.5 - 10	30	91	215	160	55	30	25	82	45	43	6000	NBC10
BDV50-AG90/NBS10-245	802.563	1.5 - 10	30	91	245	160	85	30	25	112	45	43	6000	NBC10
BDV50-AG90/NBS10-275	802.564	1.5 - 10	30	91	275	160	115	30	25	142	45	43	6000	NBC10
BDV50-AG90/NBS13-215	802.565	2.5 - 13	35	101	215	160	55	31	28	82	52	45	6000	NBC13
BDV50-AG90/NBS13-245	802.566	2.5 - 13	35	101	245	160	85	31	28	112	52	45	6000	NBC13
BDV50-AG90/NBS13-275	802.567	2.5 - 13	35	101	275	160	115	31	28	142	52	45	6000	NBC13
BDV50-AG90/NBS20-230	802.568	2.5 - 20	46	132	230	160	70	35	35	97	65	62	3000	NBC20

1. BIG-PLUS® tools can be used in machining centers with non BIG-PLUS® spindles.
2. The standard fixed length A is 8 mm for BDV40 and 6 mm for BDV50. Other lengths are available upon request.
3. Nut and wrench are included.
4. Order No. for BDV50 is with S = 110. S = 80 type for BDV50 is available upon request.
5. New Baby Collet is to be ordered separately
6. No puede utilizarse la pinza New Baby para fresado (NBC - EAA).
7. Coolant can be supplied through the locating pin.
8. Exclusive Stop Block is required.
9. „CP” indicates compression.
10. „ØF” indicates the minimum dimension for access into the bore

Accessories & Spare Parts

<p>New Baby Collets</p>  <p>▶ 327</p>	<p>Semi-Finished Stop Blocks</p>  <p>▶ 377</p>
--	---

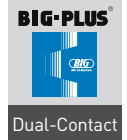

HMC Type

Improved versatility is achieved from the 32 mm Milling Chuck by using parallel reduction collets and other accessories.

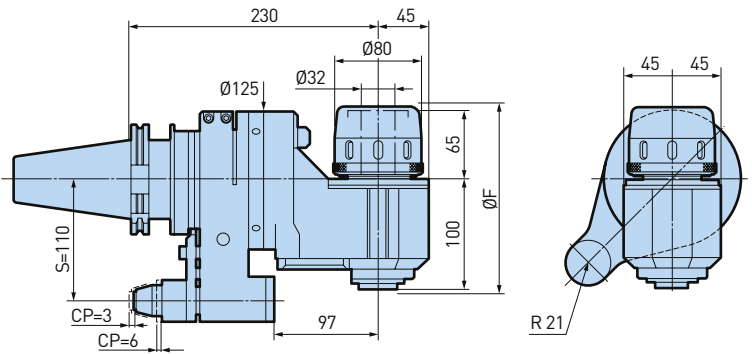

A.2

ø6 - 32mm

Model	Order No.	ØF	max. min-1
BDV50-AG90/HMC32-230	802.560	175	3000
BDV50-AG90/HMC32-230S	802.561	175	3000

1. BIG-PLUS® tools can be used in machining centers with non BIG-PLUS® spindles.
2. The standard length A is 6 mm.
3. Models with "S" at the end are high rigidity type.
4. Order No. is with S = 110. S = 80 type is available upon request.
5. Wrench (FK80-90) is included.
6. Coolant can be supplied through the locating pin.
7. Exclusive Stop Block is required.
8. „ØF“ indicates the minimum dimension for access into the bore

Accessories & Spare Parts

<p>C Collets</p>  <p>▶ 349</p>	<p>Semi-Finished Stop Blocks</p>  <p>▶ 377</p>	<p>FK Wrenches</p>  <p>▶ 352</p>
---	---	---

Build-Up Type

Designed for greater rigidity by having the face of the spindle bore in line with the center of the machine spindle. Also helps minimize interference problems with ATC and storage problems within the magazine.



A.2

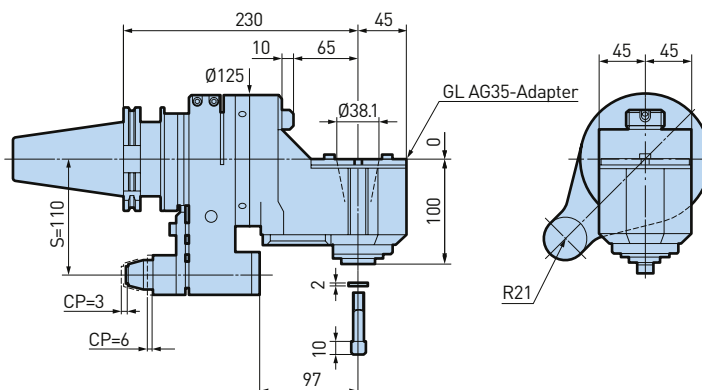

Model	Order No.	max. min-1	Connection tool side
BDV50-AG90/AGH35-230	802.558	3000	AGH35
BDV50-AG90/AGH35-230S	802.559	3000	AGH35

1. BIG-PLUS® tools can be used in machining centers with non BIG-PLUS® spindles.
2. Models with "S" at the end are high rigidity type.
3. The standard length A is 6 mm.
4. Order No. is with S = 110. S = 80 type is available upon request.
5. Coolant can be supplied through the locating pin.
6. Exclusive Stop Block is required.

Accessories & Spare Parts

Semi-Finished Stop Blocks



► 377

AG35 adapters

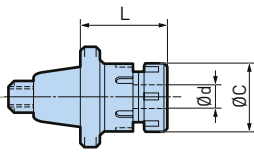
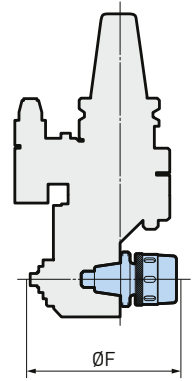
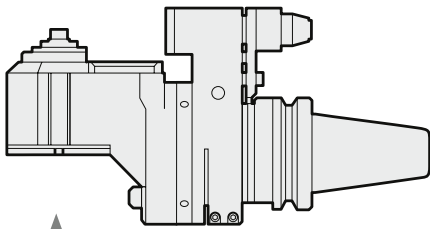

AG35 adapters New Baby Chuck

Model	Order No.	Ød	L	ØC	ØF	Collet Model
AG35-NBS10	962.793	1.5 - 10	47	30	162	NBC10
AG35-NBS13	962.794	2.5 - 13	54	35	168	NBC13
AG35-NBS16	962.795	2.5 - 16	54	42	170	NBC16
AG35-NBS20	962.796	2.5 - 20	54	46	170	NBC20

1. New baby collet and wrench are to be ordered separately.

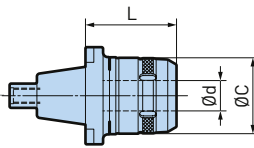

AG35 adapters New Hi-Power Milling Chuck

Model	Order No.	Ød	L	ØC	ØF	Head
AG35-HMC20S	802.742	20	60	50	178	AG35

1. Wrench (FK45-50L) is included.

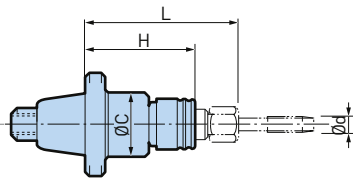

AG35 adapters Auto Tapper Type B (automatic depth control)

Model	Order No.	Ød	ØC	L	H	Head
AG35-ATB12E	802.435	M4 - M12	40.5	80	72	AG35
AG35-ATB20E	802.436	M8 - M20	57.5	115	102.5	AG35

1. Please contact BIG KAISER agent for tap collet.

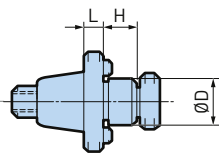

AG35 adapters Face Mill Arbor

Model	Order No.	ØD	L	H	Head
AG35-FMH22-30	802.740	22	30	18	AG35
AG35-FMH27-20	802.741	27	20	20	AG35

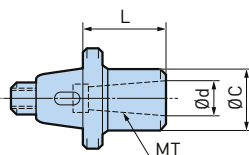

AG35 adapters Morse Taper Adapter

Model	Order No.	Ød	MT No.	L	ØC	ØF	Head
AG35-MT1	962.785	12.065	1	50	24	164	AG35
AG35-MT2	962.786	17.78	2	60	32	180	AG35

Universal Type

Suitable for cutting angles between 0° and 90°. In addition to that the cutter head can be rotated a full 360°, increasing flexibility!



A.2

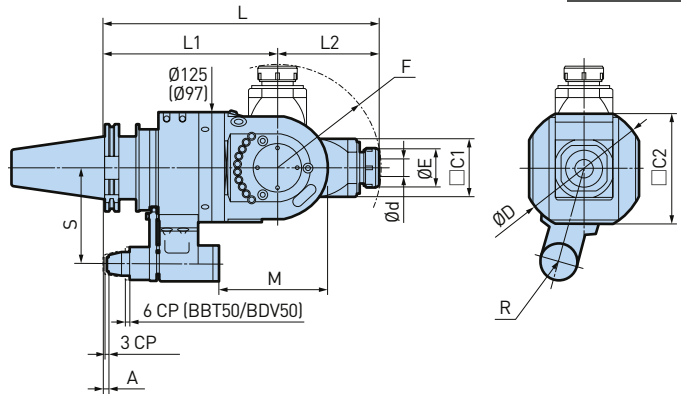

ø2.5 - 20mm

Model	Order No.	Ød	ØD	ØE	C1	C2	L	L1	L2	M	F	R	S	max. min-1	Collet Model
BDV40-AGU/NBS13-280	802.557	2.5 - 13	115	35	51	97	280	180	100	124	102	18	65	6000	NBC13
BDV50-AGU/NBS20-315	802.573	2.5 - 20	140	46	65	125	315	200	115	125	118	21	110	4000	NBC20

1. BIG-PLUS® tools can be used in machining centers with non BIG-PLUS® spindles.
2. Exclusive Stop Block is required.
3. Standard fixed length A is 6 mm for BDV50 and 8 mm for BDV40. Other lengths are available upon request.
4. Order No. for BDV50 is with S = 110. S = 80 type for BDV50 is available upon request.
5. Figures in () in the drawing indicate dimensions for BDV40.
6. Nut and wrench are included.
7. Coolant can be supplied through the locating pin.
8. „CP“ indicates compression.



Easily adjustable spindle angle from 0° to 90°.



Unique setting mechanism enables the spindle angle to be precisely set at 1° increments.



Specially selected materials and special design for clamping the head guarantees rigidity for even end milling applications.

Accessories & Spare Parts

<p>New Baby Collets</p> <p>▶ 327</p>	<p>Semi-Finished Stop Blocks</p> <p>▶ 377</p>
--------------------------------------	---

Air Turbine Spindle Center Through Type

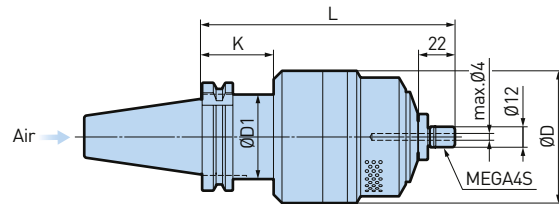

A.2

Ø0.5 - 4mm

Model	Order No.	Operation Speed (min-1)	ØD	ØD1	L	K	Nut Model
BDV40-RBX5C-4S-150	962.642	40000 - 50000	96	49.6	150	43	MGN4S
BDV40-RBX7C-4S-150	801.040	60000 - 80000	78	49.6	150	43	MGN4S
BDV50-RBX5C-4S-145	802.422	40000 - 50000	96	68	145	38	MGN4S
BDV50-RBX7C-4S-145	802.424	60000 - 80000	78	68	145	38	MGN4S

1. BIG-PLUS® tools can be used in machining centers with non BIG-PLUS® spindles.
2. Collet (NBC4S-_) and XF1 (air unit) are to be ordered separately.
3. Nut and wrench are included.

Caution

Clean air is an essential condition for the use of this product. Therefore, coolant should never be supplied through the spindle of the machine using the Air Turbine Spindle.

Accessories & Spare Parts

<p>MEGA Nuts</p> <p>▶ 326</p>	<p>Micro Collets</p> <p>▶ 324</p>	<p>MEGA Wrenches</p> <p>▶ 351</p>	<p>Air Filter Regulator for RBX</p> <p>▶ 366</p>
--------------------------------------	--	--	---

Air Turbine Spindle Side Through Type

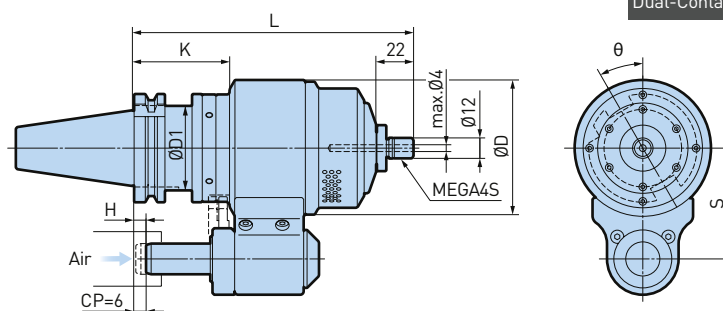

Ø0.5 - 4mm

Model	Order No.	Operation Speed (min-1)	ØD	L	K	S	H	Nut Model
BDV40-RBX5-4S-165	962.668	40000 - 50000	96	165	57	65	-10 - -35	MGN4S
BDV40-RBX7-4S-165	962.667	60000 - 80000	80	165	57	65	-10 - -35	MGN4S
BDV50-RBX5-4S-170	962.670	40000 - 50000	100	170	62	80	-5 - -40	MGN4S
BDV50-RBX7-4S-170	962.669	60000 - 80000	100	170	62	80	-5 - -40	MGN4S

1. Exclusive Stop Block is required.
2. BIG-PLUS® tools can be used in machining centers with non BIG-PLUS® spindles.
3. Nut, wrench (RBX5, 7 : XW27) and MEGA wrench (MGR12) are included.
4. Collet (NBC4S-_) and XF1 (air unit) are to be ordered separately.
5. „CP” indicates compression.
6. θ: Drive grooves adjustable 0 - 360°.

Accessories & Spare Parts

MEGA Nuts	Micro Collets	MEGA Wrenches	Semi-Finished Stop Blocks	Air Filter Regulator for RBX
				
▶ 326	▶ 324	▶ 351	▶ 377	▶ 366

Air Turbine Spindle Manual Type

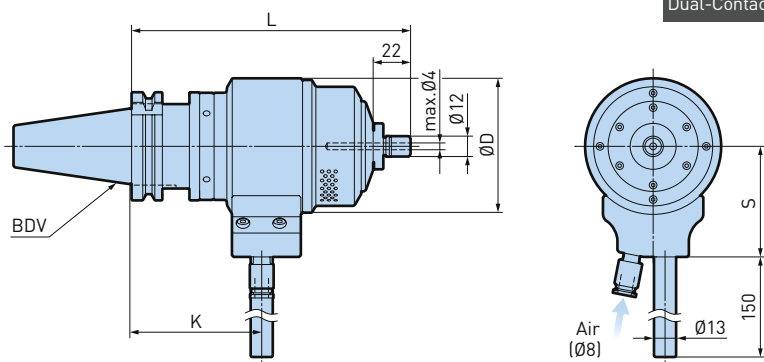

Ø0.5 - 4mm

Model	Order No.	Operation Speed (min-1)	ØD	L	K	S	Nut Model
BDV40-RBX5-4S-165H	962.649	40000 - 50000	96	151	63	71	MGN4S
BDV40-RBX7-4S-165H	801.681	60000 - 80000	80	151	63	65	MGN4S
BDV50-RBX5-4S-170H	802.421	40000 - 50000	100	166	78	80	MGN4S
BDV50-RBX7-4S-170H	802.423	60000 - 80000	100	166	78	80	MGN4S

1. BIG-PLUS® tools can be used in machining centers with non BIG-PLUS® spindles.
2. Collet (NBC4S-_) and XF1 (air unit) are to be ordered separately.
3. Nut and wrench are included.

A.2

Accessories & Spare Parts

<p>MEGA Nuts</p> <p>▶ 326</p>	<p>Micro Collets</p> <p>▶ 324</p>	<p>MEGA Wrenches</p> <p>▶ 351</p>	<p>Air Filter Regulator for RBX</p> <p>▶ 366</p>
--------------------------------------	--	--	---

Application Examples

RBX7

Aluminium A2017

Outstanding runout accuracy permits perfect thin wall cutting.

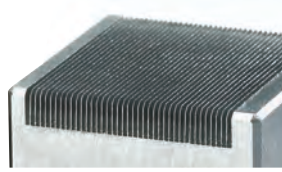
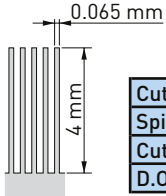

Cutter	Ø 0.5 mm Rib-endmill
Spindle Speed	70 000 min ⁻¹
Cutting Feed	1 500 mm/min
D.O.C	ap = 0.02 mm

Prehardened steel HRC40

Drastic time reduction by ultra high speed rotation. Excellent dynamic runout accuracy makes DOC of 5 µm clearly visible.

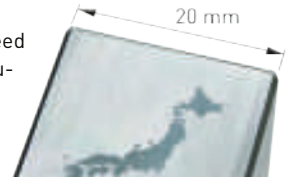

Cutter	R0.1 mm Ball nose endmill
Spindle Speed	80 000 min ⁻¹
Cutting Feed	400 mm/min
D.O.C	ap = 0.01 mm

Prehardened steel HRC40

Overall cutting length of 656 m can be achieved with one ball nose endmill. Drastically extended tool life.



Cutter	R0.5 mm Ball nose endmill
Spindle Speed	65 000 min ⁻¹
Cutting Feed	4 200 mm/min
D.O.C	ap = 0.02 mm; ae = 0.05 mm

Prehardened steel HRC40

Original 5hour operation in MC is reduced to 2 hours.

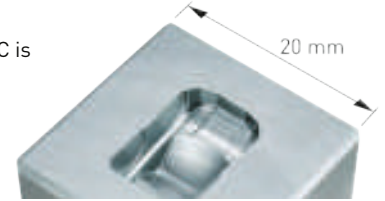

Cutter	R0.2 mm Ball nose endmill
Spindle Speed	70 000 min ⁻¹
Cutting Feed	1 000 mm/min
D.O.C	ap = 0.01 mm

Prehardened steel HRC40

No thermal expansion of spindle results in finely detailed surface finish.

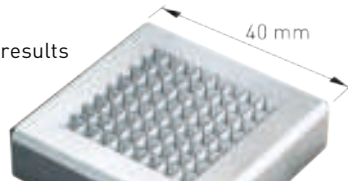

Cutter	R0.5 mm Ball nose endmill
Spindle Speed	75 000 min ⁻¹
Cutting Feed	400 mm/min
D.O.C	ap = 0.02 mm

Aluminium A2017

High-precision drilling is possible without center drill operation. Even after 3500 holes, no problems can be found on the cutting edge.

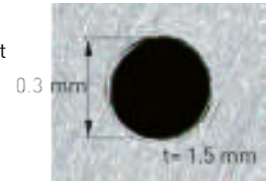

Cutter	Ø 0.3 mm Solid drill
Spindle Speed	75 000 min ⁻¹
Cutting Feed	200 mm/min
Peck	ap = 0.03 mm

RBX5

Prehardened steel HRC40

Even a taper endmill that has high cutting forces can achieve stable cutting.

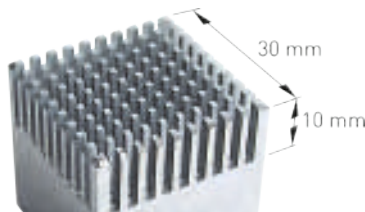

Cutter	Ø 1.5 mm Rib-endmill
Spindle Speed	40 000 min ⁻¹
Cutting Feed	1 000 mm/min
D.O.C	ap = 0.05 mm

Stainless steel SUS303

Tool life is doubled with over 1200 holes and cutting time is reduced to 1/3.

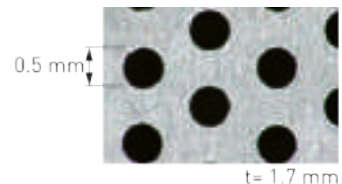

Cutter	Ø 0.5 mm Solid drill
Spindle Speed	40 000 min ⁻¹
Cutting Feed	20 mm/min
Peck	ap = 0.01 mm

Tool Holders HSK, DIN 69893, ISO 12164

	HSK-A	HSK-E	HSK-F
MEGA Micro Chuck	164	216	223
MEGA New Baby Chuck	166	218	224
MEGA E Chuck	170		225
MEGA Double Power Chuck	172		226
MEGA Perfect Grip	176		
New Baby Chuck	177		
New Hi-Power Milling Chuck	180		
Hydraulic Chucks	184	220	
Mold Chuck	188		
Shrink Chuck	189		
CK Shanks	191	222	
Face Mill Arbors	194		
Smart Damper Face Mill	196		
Super Keyless Chuck	198		
Side Lock Holders	199		
Morse Taper Holder	200		
MEGA Synchro Tapping Holder	201		
Angle Heads	203		
Air Turbine Spindle	213		
HSK Accessories	228	228	228

A.3

● Preferred selected items

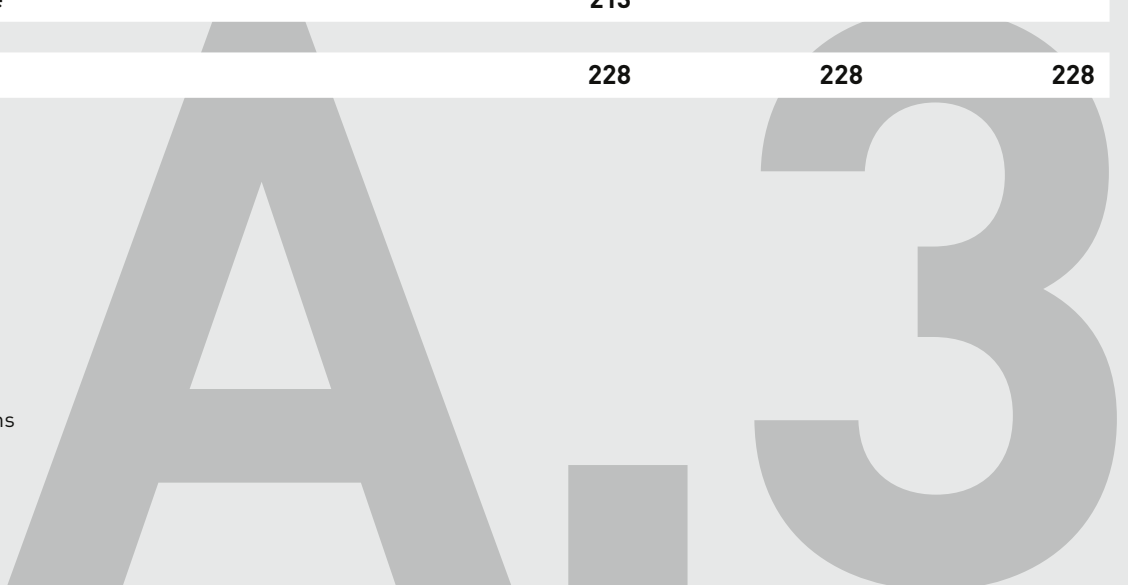

MEGA Micro Chuck Type T

Tapered and slim design, minimal interference combined with maximized rigidity.

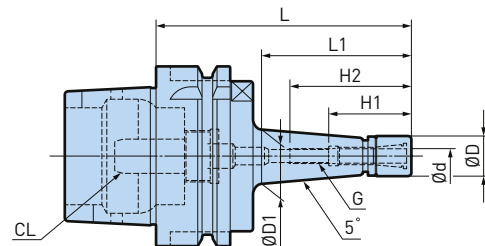







A.3

ø0.45 - 8.05mm

Model	Order No.	Ød	ØD	ØD1	L	L1	H1	H2	G	max. min-1	Collet Model
HSK-A32-MEGA6S-50T *	806.804A	0.45 - 6.05	14	14.8	50	22	28.5	33	-	42000	NBC6S
HSK-A32-MEGA6S-60T *	978.370	0.45 - 6.05	14	16	60	30	28.5	43	-	40000	NBC6S
HSK-A32-MEGA6S-105T	978.372	0.45 - 6.05	14	22.1	105	76	28.5	63	M7 P0.75	35000	NBC6S
HSK-A40-MEGA3S-75T	968.936	• 0.45 - 3.25	10	16	75	44	22	38	M4 P0.7	32000	NBC3S
HSK-A40-MEGA3S-90T	968.937	• 0.45 - 3.25	10	18	90	60	22	38	M4 P0.7	28000	NBC3S
HSK-A40-MEGA4S-60T	968.934	• 0.45 - 4.05	12	14	60	27	26.5	44	M5 P0.8	35000	NBC4S
HSK-A40-MEGA4S-90T	802.355	• 0.45 - 4.05	12	20	90	60	26.5	47	M5 P0.8	28000	NBC4S
HSK-A40-MEGA4S-105T	802.356	• 0.45 - 4.05	12	23	105	76	26.5	47	M5 P0.8	25000	NBC4S
HSK-A40-MEGA6S-60T *	968.925	• 0.45 - 6.05	14	16	60	29	-	40	-	35000	NBC6S
HSK-A40-MEGA6S-75T	968.926	• 0.45 - 6.05	14	19	75	45	28.5	49	M7 P0.75	32000	NBC6S
HSK-A40-MEGA6S-90T	968.927	• 0.45 - 6.05	14	21.5	90	60	28.5	49	M7 P0.75	28000	NBC6S
HSK-A40-MEGA6S-105T	802.357	• 0.45 - 6.05	14	25	105	76	28.5	49	M7 P0.75	25000	NBC6S
HSK-A50-MEGA6S-75T	805.828	• 0.45 - 6.05	14	17	75	36	28.5	49	M7 P0.75	30000	NBC6S
HSK-A50-MEGA6S-105T	805.251	• 0.45 - 6.05	14	22.5	105	66	28.5	49	M7 P0.75	25000	NBC6S
HSK-A63-MEGA3S-75T	968.961	• 0.45 - 3.25	10	14	75	36	22	38	M4 P0.7	32000	NBC3S
HSK-A63-MEGA3S-120T	968.963	• 0.45 - 3.25	10	21.5	120	81	22	38	M4 P0.7	25000	NBC3S
HSK-A63-MEGA4S-75T	805.259	• 0.45 - 4.05	12	15.5	75	36	26.5	47	M5 P0.8	32000	NBC4S
HSK-A63-MEGA4S-90T	968.966	• 0.45 - 4.05	12	18	90	51	26.5	47	M5 P0.8	28000	NBC4S
HSK-A63-MEGA4S-120T	968.968	• 0.45 - 4.05	12		120	81	26.5	47	M5 P0.8	22000	NBC4S
HSK-A63-MEGA6S-60T	968.970	• 0.45 - 6.05	14	15.5	60	23	28.5	37	M7 P0.75	35000	NBC6S
HSK-A63-MEGA6S-75T	968.971	• 0.45 - 6.05	14	17	75	36	28.5	48	M7 P0.75	32000	NBC6S
HSK-A63-MEGA6S-90T	805.260	• 0.45 - 6.05	14	20	90	51	28.5	49	M7 P0.75	28000	NBC6S
HSK-A63-MEGA6S-105T	968.973	• 0.45 - 6.05	14	22.5	105	66	28.5	49	M7 P0.75	25000	NBC6S
HSK-A63-MEGA6S-120T	805.261	• 0.45 - 6.05	14	25	120	81	28.5	49	M7 P0.75	22000	NBC6S
HSK-A63-MEGA6S-135T	968.975	• 0.45 - 6.05	14	27.5	135	96	28.5	49	M7 P0.75	20000	NBC6S
HSK-A63-MEGA8S-90T	801.724	• 2.95 - 8.05	18	23.5	90	51	31	50.5	M9 P0.75	30000	NBC8S
HSK-A63-MEGA8S-120T	803.603	• 2.95 - 8.05	18	28.5	120	81	31	50.5	M9 P0.75	22000	NBC8S

1. MEGA nut is included in delivery.
2. Coolant pipe (CL) is to be ordered separately.
3. * Internal thread (G) is not available.

Accessories & Spare Parts

MEGA Nuts	Micro Seal Nuts	Micro Collets	MEGA Wrenches	Taper Cleaners	Collet Protective Cases	Coolant Pipes
						
▶ 326	▶ 326	▶ 324	▶ 351	▶ 370	▶ 326	▶ 228

MEGA Micro Chuck Type S

Micro diameter design is ideal for high speed applications in tight spaces.

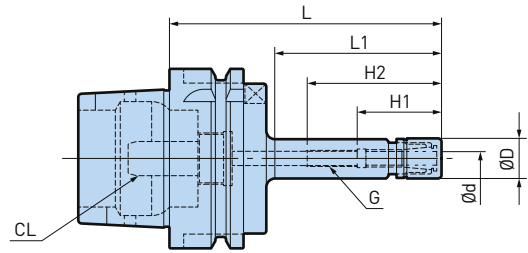
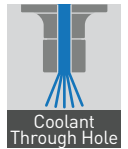

A.3

ø0.45 - 8.05mm

Model	Order No.	Ød	ØD	L	L1	H1	H2	G	max. min-1	Collet Model
HSK-A32-MEGA6S-60 *	805.174	0.45 - 6.05	14	60	30	23.5	43	-	38000	NBC6S
HSK-A32-MEGA6S-105	978.104	0.45 - 6.05	14	105	76	23.5	49	M7 P0.75	30000	NBC6S
HSK-A40-MEGA3S-60	968.933	0.45 - 3.25	10	60	26	22	39	M4 P0.7	30000	NBC3S
HSK-A40-MEGA4S-60	968.931	0.45 - 4.05	12	60	27	26.5	44	M5 P0.8	30000	NBC4S
HSK-A40-MEGA4S-90	968.932	0.45 - 4.05	12	90	57	26.5	47	M5 P0.8	25000	NBC4S
HSK-A40-MEGA6S-60 *	968.929	0.45 - 6.05	14	60	28	-	40	-	30000	NBC6S
HSK-A40-MEGA6S-90	968.930	0.45 - 6.05	14	90	58	28.5	49	M7 P0.75	25000	NBC6S
HSK-A50-MEGA4S-75	978.310	0.45 - 4.05	12	75	36	26.5	47	M5 P0.8	30000	NBC4S
HSK-A50-MEGA6S-75	805.250	0.45 - 6.05	14	75	36	28.5	49	M7 P0.75	30000	NBC6S
HSK-A63-MEGA4S-75	968.965	0.45 - 4.05	12	75	36	26.5	48	M5 P0.8	30000	NBC4S
HSK-A63-MEGA4S-105	805.257	0.45 - 4.05	12	105	61	26.5	47	M5 P0.8	25000	NBC4S
HSK-A63-MEGA6S-75	968.803	0.45 - 6.05	14	75	36	-	48	M7 P0.75	30000	NBC6S
HSK-A63-MEGA6S-105	805.258	0.45 - 6.05	14	105	61	28.5	49	M7 P0.75	25000	NBC6S
HSK-A63-MEGA8S-90	803.600	2.95 - 8.05	18	90	48	31	50.5	M9 P0.75	30000	NBC8S

1. MEGA nut is included in delivery.
2. Coolant pipe (CL) is to be ordered separately.
3. * Internal thread (G) is not available.

Accessories & Spare Parts

<p>MEGA Nuts</p> <p>▶ 326</p>	<p>Micro Seal Nuts</p> <p>▶ 326</p>	<p>Micro Collets</p> <p>▶ 324</p>	<p>MEGA Wrenches</p> <p>▶ 351</p>	<p>Taper Cleaners</p> <p>▶ 370</p>	<p>Collet Protective Cases</p> <p>▶ 326</p>	<p>Coolant Pipes</p> <p>▶ 228</p>
--------------------------------------	--	--	--	---	--	--

MEGA New Baby Chuck

Ideal ultra precision collet holders for high speed machining. Wide range of lengths and a variety of collet series covers all machining applications.



A.3

Ø0.25 - 25.4mm

Model	Order No.	Ød	ØD	L	L1	H	max. min-1	Collet Model
HSK-A32-MEGA6N-75	979.010	0.25 - 6	20	75	37	23 - 43	30000	NBC6
HSK-A32-MEGA8N-50 *	806.800	0.5 - 8	25	50	26	32	30000	NBC8
HSK-A40-MEGA6N-60 *	968.940	• 0.25 - 6	20	60	30	33	35000	NBC6
HSK-A40-MEGA6N-75	968.941	0.25 - 6	20	75	45	23 - 38	30000	NBC6
HSK-A40-MEGA6N-90	968.942	0.25 - 6	20	90	60	23 - 43	30000	NBC6
HSK-A40-MEGA8N-60 *	968.943	• 0.5 - 8	25	60	30	41	35000	NBC8
HSK-A40-MEGA8N-90	968.945	0.5 - 8	25	90	60	26 - 44	30000	NBC8
HSK-A40-MEGA10N-60 *	968.946	• 1.5 - 10	30	60	26	40	32000	NBC10
HSK-A40-MEGA10N-90	968.948	1.5 - 10	30	90	54	38 - 48	28000	NBC10
HSK-A40-MEGA13N-75 *	968.949	2.5 - 13	35	75	55	55	25000	NBC13
HSK-A40-MEGA13N-90 *	968.950	2.5 - 13	35	90	70	64	25000	NBC13
HSK-A40-MEGA16N-75 *	968.951	2.5 - 16	42	75	55	53	20000	NBC16
HSK-A40-MEGA16N-90 *	968.952	2.5 - 16	42	90	70	63	15000	NBC16
HSK-A40-MEGA20N-90 *	968.953	• 2.5 - 20	46	90	70	66	15000	NBC20

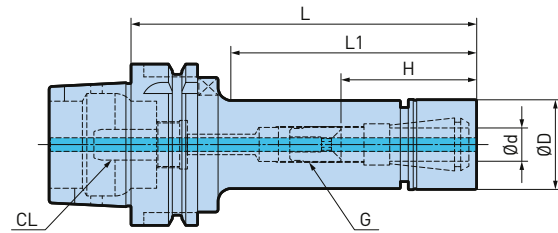

A.3

Model	Order No.	Ød	ØD	L	L1	H	max. min-1	Collet Model
HSK-A50-MEGA6N-75	805.252	0.25 - 6	20	75	37	23 - 43	30000	NBC6
HSK-A50-MEGA6N-100	978.031	• 0.25 - 6	20	100	60	23 - 43	25000	NBC6
HSK-A50-MEGA6N-135	968.745	0.25 - 6	20	135	93	23 - 43	20000	NBC6
HSK-A50-MEGA6N-165	803.625	0.25 - 6	20	165	123	23 - 43	15000	NBC6
HSK-A50-MEGA8N-75	968.738	0.5 - 8	25	75	37	26 - 37	30000	NBC8
HSK-A50-MEGA8N-100	978.239	0.5 - 8	25	100	62	26 - 45	28000	NBC8
HSK-A50-MEGA8N-135	803.629	0.5 - 8	25	135	96	26 - 45	20000	NBC8
HSK-A50-MEGA8N-165	803.616	0.5 - 8	25	165	125	26 - 45	14000	NBC8
HSK-A50-MEGA10N-75 *	805.253	• 1.5 - 10	30	75	38	46	33000	NBC10
HSK-A50-MEGA10N-100	978.261	1.5 - 10	30	100	63	38 - 48	25000	NBC10
HSK-A50-MEGA10N-135	803.622	1.5 - 10	30	135	98	38 - 48	20000	NBC10
HSK-A50-MEGA10N-165	803.627	1.5 - 10	30	165	128	38 - 48	14000	NBC10
HSK-A50-MEGA13N-75 *	805.254	• 2.5 - 13	35	75	40	46	28000	NBC13
HSK-A50-MEGA13N-100	801.179	2.5 - 13	35	100	65	44 - 56	25000	NBC13
HSK-A50-MEGA13N-135	803.620	2.5 - 13	35	135	100	44 - 63	18000	NBC13
HSK-A50-MEGA13N-165	978.262	2.5 - 13	35	165	130	44 - 63	12000	NBC13
HSK-A50-MEGA16N-75 *	805.255	• 2.5 - 16	42	75	49	48	28000	NBC16
HSK-A50-MEGA16N-100	803.623	2.5 - 16	42	100	74	48 - 55	20000	NBC16
HSK-A50-MEGA16N-135	803.619	2.5 - 16	42	135	109	48 - 68	15000	NBC16
HSK-A50-MEGA16N-165	803.626	2.5 - 16	42	165	139	48 - 68	10000	NBC16
HSK-A50-MEGA20N-75 **	805.256	• 2.5 - 20	46	75	49	47	20000	NBC20
HSK-A50-MEGA20N-100	968.742	2.5 - 20	46	100	74	51 - 54	15000	NBC20
HSK-A50-MEGA20N-135	803.624	2.5 - 20	46	135	109	51 - 68	10000	NBC20
HSK-A50-MEGA20N-165	803.621	2.5 - 20	46	165	139	51 - 68	8000	NBC20
HSK-A50-MEGA25N-95 *	806.370	15.5 - 25.4	60	95	69	65	12000	NBC25

continues on the next page



A.3



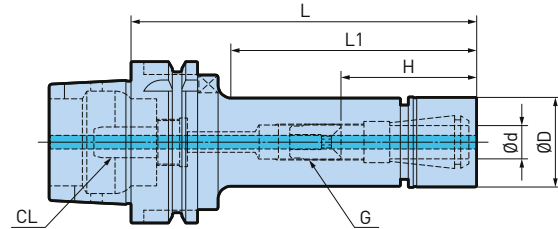



Model	Order No.	Ød	ØD	L	L1	H	max. min-1	Collet Model
HSK-A63-MEGA6N-75	968.811	0.25 - 6	20	75	35	23 - 38	35000	NBC6
HSK-A63-MEGA6N-90	805.262	• 0.25 - 6	20	90	48	23 - 43	30000	NBC6
HSK-A63-MEGA6N-105	968.812	0.25 - 6	20	105	63	23 - 43	30000	NBC6
HSK-A63-MEGA6N-120	968.981	0.25 - 6	20	120	76	23 - 43	25000	NBC6
HSK-A63-MEGA6N-135	968.813	0.25 - 6	20	135	91	23 - 43	20000	NBC6
HSK-A63-MEGA6N-165	968.814	• 0.25 - 6	20	165	121	23 - 43	15000	NBC6
HSK-A63-MEGA8N-75	968.815	0.5 - 8	25	75	35	26 - 38	35000	NBC8
HSK-A63-MEGA8N-90	805.263	0.5 - 8	25	90	50	26 - 45	30000	NBC8
HSK-A63-MEGA8N-105	968.816	0.5 - 8	25	105	63	26 - 45	30000	NBC8
HSK-A63-MEGA8N-120	968.982	0.5 - 8	25	120	76	26 - 45	25000	NBC8
HSK-A63-MEGA8N-135	805.264	0.5 - 8	25	135	91	26 - 45	20000	NBC8
HSK-A63-MEGA8N-165	968.818	0.5 - 8	25	165	121	26 - 45	15000	NBC8
HSK-A63-MEGA10N-75 *	968.819	1.5 - 10	30	75	36	50	33000	NBC10
HSK-A63-MEGA10N-90	805.265	1.5 - 10	30	90	50	38 - 45	33000	NBC10
HSK-A63-MEGA10N-105	968.820	1.5 - 10	30	105	65	38 - 48	25000	NBC10
HSK-A63-MEGA10N-120	968.983	1.5 - 10	30	120	80	38 - 48	25000	NBC10
HSK-A63-MEGA10N-135	805.266	1.5 - 10	30	135	93	38 - 48	20000	NBC10
HSK-A63-MEGA10N-165	968.822	1.5 - 10	30	165	123	38 - 48	15000	NBC10
HSK-A63-MEGA13N-75 *	968.823	2.5 - 13	35	75	37	49	30000	NBC13
HSK-A63-MEGA13N-90 *	805.267	• 2.5 - 13	35	90	51	64	30000	NBC13
HSK-A63-MEGA13N-105	968.824	2.5 - 13	35	105	66	44 - 56	25000	NBC13
HSK-A63-MEGA13N-120	968.984	2.5 - 13	35	120	81	44 - 63	20000	NBC13
HSK-A63-MEGA13N-135	805.268	• 2.5 - 13	35	135	96	44 - 63	20000	NBC13
HSK-A63-MEGA13N-165	968.826	2.5 - 13	35	165	125	44 - 63	15000	NBC13
HSK-A63-MEGA16N-75 *	968.827	2.5 - 16	42	75	39	48	30000	NBC16
HSK-A63-MEGA16N-90 *	805.269	2.5 - 16	42	90	54	63	25000	NBC16
HSK-A63-MEGA16N-105	968.828	2.5 - 16	42	105	69	48 - 54	20000	NBC16
HSK-A63-MEGA16N-120	968.985	2.5 - 16	42	120	84	48 - 68	15000	NBC16
HSK-A63-MEGA16N-135	968.829	2.5 - 16	42	135	99	48 - 68	15000	NBC16
HSK-A63-MEGA16N-165	968.830	2.5 - 16	42	165	129	48 - 68	10000	NBC16
HSK-A63-MEGA16N-200	968.831	2.5 - 16	42	200	164	48 - 68	8000	NBC16
HSK-A63-MEGA20N-75 *	968.832	2.5 - 20	46	75	39	51	30000	NBC20
HSK-A63-MEGA20N-90 *	805.270	• 2.5 - 20	46	90	54	61	25000	NBC20
HSK-A63-MEGA20N-105	968.833	2.5 - 20	46	105	69	51 - 54	20000	NBC20
HSK-A63-MEGA20N-120	968.986	• 2.5 - 20	46	120	84	51 - 68	15000	NBC20
HSK-A63-MEGA20N-135	805.271	2.5 - 20	46	135	99	51 - 68	15000	NBC20
HSK-A63-MEGA20N-165	968.835	2.5 - 20	46	165	129	51 - 68	10000	NBC20
HSK-A63-MEGA20N-200	968.836	2.5 - 20	46	200	164	51 - 68	8000	NBC20
HSK-A63-MEGA25N-90 *	806.371	15.5 - 25.4	60	90	-	63	20000	NBC25
HSK-A63-MEGA25N-120 *	806.372	15.5 - 25.4	60	120	-	90	12000	NBC25



Model	Order No.	Ød	ØD	L	L1	H	max. min-1	Collet Model
HSK-A100-MEGA6N-90	968.841	0.25 - 6	20	90	43	23 - 43	20000	NBC6
HSK-A100-MEGA6N-105	801.146	0.25 - 6	20	105	58	23 - 43	18000	NBC6
HSK-A100-MEGA6N-120	968.842	0.25 - 6	20	120	73	23 - 43	18000	NBC6
HSK-A100-MEGA6N-135	801.147	0.25 - 6	20	135	88	23 - 43	14000	NBC6
HSK-A100-MEGA6N-165	968.843	0.25 - 6	20	165	113	23 - 43	12000	NBC6
HSK-A100-MEGA8N-90	968.844	0.5 - 8	25	90	43	26 - 45	20000	NBC8
HSK-A100-MEGA8N-105	968.989	0.5 - 8	25	105	58	26 - 45	18000	NBC8
HSK-A100-MEGA8N-120	968.845	0.5 - 8	25	120	73	26 - 45	18000	NBC8
HSK-A100-MEGA8N-135	968.990	0.5 - 8	25	135	88	26 - 45	14000	NBC8
HSK-A100-MEGA8N-165	968.846	0.5 - 8	25	165	113	26 - 45	14000	NBC8
HSK-A100-MEGA10N-90	968.847	1.5 - 10	30	90	43	38 - 45	20000	NBC10
HSK-A100-MEGA10N-105	968.991	1.5 - 10	30	105	58	38 - 48	18000	NBC10
HSK-A100-MEGA10N-120	968.848	1.5 - 10	30	120	73	38 - 48	18000	NBC10
HSK-A100-MEGA10N-135	968.992	1.5 - 10	30	135	88	38 - 48	14000	NBC10
HSK-A100-MEGA10N-165	968.849	1.5 - 10	30	165	113	38 - 48	14000	NBC10
HSK-A100-MEGA13N-90 *	968.850	2.5 - 13	35	90	43	55	18000	NBC13
HSK-A100-MEGA13N-105 *	968.993	2.5 - 13	35	105	58	70	16000	NBC13
HSK-A100-MEGA13N-120	968.851	2.5 - 13	35	120	73	44 - 63	16000	NBC13
HSK-A100-MEGA13N-135	968.994	2.5 - 13	35	135	88	44 - 63	14000	NBC13
HSK-A100-MEGA13N-165	968.852	2.5 - 13	35	165	118	44 - 63	14000	NBC13
HSK-A100-MEGA13N-200	968.853	2.5 - 13	35	200	148	44 - 63	10000	NBC13
HSK-A100-MEGA16N-90 *	968.854	2.5 - 16	42	90	47	55	15000	NBC16
HSK-A100-MEGA16N-105 *	968.995	2.5 - 16	42	105	58	70	14000	NBC16
HSK-A100-MEGA16N-120	968.855	2.5 - 16	42	120	73	48 - 68	14000	NBC16
HSK-A100-MEGA16N-135	968.996	2.5 - 16	42	135	88	48 - 68	13000	NBC16
HSK-A100-MEGA16N-165	968.856	2.5 - 16	42	165	118	48 - 68	13000	NBC16
HSK-A100-MEGA16N-200	968.857	2.5 - 16	42	200	151	48 - 68	10000	NBC16
HSK-A100-MEGA20N-90 *	968.858	2.5 - 20	46	90	47	55	15000	NBC20
HSK-A100-MEGA20N-105 *	968.997	2.5 - 20	46	105	58	70	14000	NBC20
HSK-A100-MEGA20N-120	968.859	2.5 - 20	46	120	73	51 - 68	14000	NBC20
HSK-A100-MEGA20N-135	968.998	2.5 - 20	46	135	88	51 - 68	13000	NBC20
HSK-A100-MEGA20N-165	968.860	2.5 - 20	46	165	118	51 - 68	13000	NBC20
HSK-A100-MEGA20N-200	968.861	2.5 - 20	46	200	153	51 - 68	10000	NBC20
HSK-A100-MEGA25N-120 *	806.373	15.5 - 25.4	60	120	78	85	12000	NBC25
HSK-A100-MEGA25N-165	806.374	15.5 - 25.4	60	165	123	64 - 74	10000	NBC25
HSK-A125-MEGA20N-120	805.290	2.5 - 20	46	120	72	51 - 68	12000	NBC20
HSK-A125-MEGA20N-165	806.575	2.5 - 20	46	165	117	51 - 68	10000	NBC20

1. MEGA nut is included in delivery.
2. Coolant pipe [CL] is to be ordered separately.
3. "G" is the adjusting screw [optional].
4. "H" is the max. tool shank length that can be inserted for these models.
5. * Adjusting screws can not be used. "H" is the max. tool shank length that can be inserted for these models.
6. ** Adjusting screw and New Baby Endmill collet (NBC-E) cannot be used.

Accessories & Spare Parts

<p>MEGA Nuts</p>  <p>▶ 334</p>	<p>MEGA Perfect Seals</p>  <p>▶ 336</p>	<p>New Baby Collets</p>  <p>▶ 327</p>	<p>MEGA Wrenches</p>  <p>▶ 351</p>	<p>Adjusting Screws NBA</p>  <p>▶ 335</p>	<p>Taper Cleaners</p>  <p>▶ 370</p>	<p>Coolant Pipes</p>  <p>▶ 228</p>
--	---	---	--	--	---	--

MEGA E Chuck

Collet chuck designed exclusively for milling with high precision in hard materials.

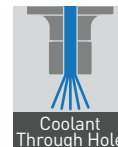

A.3

ø3 - 12mm



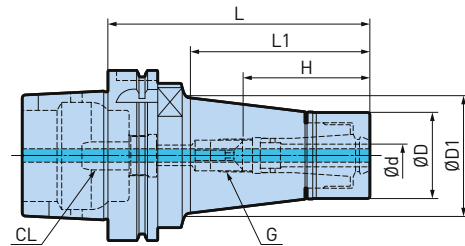



Model	Order No.	Ød	ØD	ØD1	L	L1	H	max. min-1	Collet Model
HSK-A40-MEGA6E-60 *	968.235	• 3 - 6	25	26	60	24	41	35000	MEC6
HSK-A40-MEGA6E-75 *	968.236	3 - 6	25	28.5	75	39	55	35000	MEC6
HSK-A40-MEGA8E-65 *	968.238	3 - 8	30	34	65	30	44	35000	MEC8
HSK-A40-MEGA8E-75 *	968.239	3 - 8	30	34	75	40	54	30000	MEC8
HSK-A40-MEGA10E-70 *	968.241	3 - 10	35	35	70	35	48	30000	MEC10
HSK-A40-MEGA10E-90	968.242	3 - 10	35	35	90	55	48 - 52	25000	MEC10
HSK-A40-MEGA13E-70 *	968.243	3 - 12	42	42	70	35	50	30000	MEC13
HSK-A40-MEGA13E-90 *	968.244	3 - 12	42	42	90	55	67	25000	MEC13
HSK-A50-MEGA6E-75	803.221	3 - 6	25	28.5	75	37	37 - 43	30000	MEC6
HSK-A50-MEGA8E-75 *	803.222	3 - 8	30	33	75	40	42	30000	MEC8
HSK-A50-MEGA10E-75 *	978.170	3 - 10	35	38	75	40	48	30000	MEC10
HSK-A50-MEGA13E-75 *	978.010	3 - 12	42	-	75	49	50	30000	MEC13
HSK-A50-MEGA13E-100	803.220	3 - 12	42	-	100	74	50 - 55	25000	MEC13
HSK-A63-MEGA6E-65 *	968.247	3 - 6	25	26.5	65	28	43	30000	MEC6
HSK-A63-MEGA6E-90	968.248	3 - 6	25	30	90	51	37 - 45	30000	MEC6
HSK-A63-MEGA6E-105	968.249	3 - 6	25	33	105	66	37 - 45	29000	MEC6
HSK-A63-MEGA6E-120	968.250	3 - 6	25	36	120	82	37 - 45	29000	MEC6
HSK-A63-MEGA6E-135	968.251	3 - 6	25	39	135	99	37 - 45	27000	MEC6
HSK-A63-MEGA8E-67 *	968.252	3 - 8	30	31.5	67	30	45	30000	MEC8
HSK-A63-MEGA8E-90	968.253	3 - 8	30	35	90	52	37 - 45	30000	MEC8
HSK-A63-MEGA8E-105	968.254	3 - 8	30	38	105	68	42 - 51	29000	MEC8
HSK-A63-MEGA8E-120	968.255	3 - 8	30	40.5	120	83	42 - 51	28000	MEC8
HSK-A63-MEGA8E-135	968.256	3 - 8	30	44	135	100	42 - 51	27000	MEC8
HSK-A63-MEGA10E-75 *	968.257	3 - 10	35	37.5	75	37	48	30000	MEC10
HSK-A63-MEGA10E-90 *	968.258	• 3 - 10	35	40	90	53	64	30000	MEC10
HSK-A63-MEGA10E-105	968.259	3 - 10	35	43	105	69	48 - 58	29000	MEC10
HSK-A63-MEGA10E-120	968.260	3 - 10	35	46	120	85	48 - 58	28000	MEC10
HSK-A63-MEGA10E-135	968.261	3 - 10	35	43	135	99	48 - 58	27000	MEC10
HSK-A63-MEGA13E-75 *	968.262	3 - 12	42	44	75	31	49	30000	MEC13
HSK-A63-MEGA13E-90 *	968.263	3 - 12	42	45	90	46	64	30000	MEC13
HSK-A63-MEGA13E-105	968.264	3 - 12	42	46	105	61	50 - 57	29000	MEC13
HSK-A63-MEGA13E-120	968.265	• 3 - 12	42	47.5	120	77	50 - 57	28000	MEC13
HSK-A63-MEGA13E-135	968.266	3 - 12	42	47	135	92	50 - 57	26000	MEC13



Model	Order No.	Ød	ØD	ØD1	L	L1	H	max. min-1	Collet Model
HSK-A100-MEGA6E-75 *	968.268	3 - 6	25	28	75	33	46	20000	MEC6
HSK-A100-MEGA6E-90	968.269	3 - 6	25	29.5	90	48	37 - 45	20000	MEC6
HSK-A100-MEGA6E-105	968.270	3 - 6	25	32.5	105	63	37 - 45	20000	MEC6
HSK-A100-MEGA6E-120	968.271	3 - 6	25	35	120	78	37 - 45	18000	MEC6
HSK-A100-MEGA6E-135	968.272	3 - 6	25	37.5	135	93	37 - 45	14000	MEC6
HSK-A100-MEGA6E-165	968.273	3 - 6	25	43	165	123	37 - 45	12000	MEC6
HSK-A100-MEGA8E-75 *	968.274	3 - 8	30	33	75	33	46	20000	MEC8
HSK-A100-MEGA8E-90	968.275	3 - 8	30	34.5	90	48	42 - 51	20000	MEC8
HSK-A100-MEGA8E-105	968.276	3 - 8	30	37	105	63	42 - 51	20000	MEC6
HSK-A100-MEGA8E-120	968.277	3 - 8	30	39.5	120	78	42 - 51	18000	MEC8
HSK-A100-MEGA8E-135	968.278	3 - 8	30	42.5	135	93	42 - 51	16000	MEC8
HSK-A100-MEGA8E-165	968.279	3 - 8	30	47.5	165	123	42 - 51	14000	MEC8
HSK-A100-MEGA10E-80 *	968.280	3 - 10	35	37.5	80	38	51	20000	MEC10
HSK-A100-MEGA10E-90 *	968.281	3 - 10	35	39.5	90	48	61	20000	MEC10
HSK-A100-MEGA10E-105	968.282	3 - 10	35	42	105	63	48 - 58	20000	MEC10
HSK-A100-MEGA10E-120	968.283	3 - 10	35	44.5	120	78	48 - 58	18000	MEC10
HSK-A100-MEGA10E-135	968.284	3 - 10	35	47	135	93	48 - 58	16000	MEC10
HSK-A100-MEGA10E-165	968.285	3 - 10	35	52.5	165	123	48 - 58	14000	MEC10
HSK-A100-MEGA13E-90 *	968.287	• 3 - 12	42	46	90	48	50	18000	MEC13
HSK-A100-MEGA13E-105	968.288	3 - 12	42	48.5	105	63	50 - 61	18000	MEC13
HSK-A100-MEGA13E-120	968.289	3 - 12	42	51.5	120	78	50 - 61	16000	MEC13
HSK-A100-MEGA13E-135	968.290	3 - 12	42	54	135	93	50 - 61	14000	MEC13
HSK-A100-MEGA13E-165	968.291	• 3 - 12	42	59	165	123	50 - 61	14000	MEC13

- MEGA E nut is included.
- Coolant pipe (CL) is to be ordered separately.
- * Adjusting screws can not be used. "H" is the max. tool shank length that can be inserted for these models.
- "G" is the adjusting screw (optional).
- "H" is the max. tool shank length that can be inserted for these models.

Accessories & Spare Parts

<p>MEGA E Nuts</p>  <p>► 340</p>	<p>MEGA E Perfect Seals</p>  <p>► 341</p>	<p>MEGA E Collets</p>  <p>► 340</p>	<p>MEGA Wrenches</p>  <p>► 351</p>	<p>Adjusting Screws NBA</p>  <p>► 335</p>	<p>Taper Cleaners</p>  <p>► 370</p>	<p>Coolant Pipes</p>  <p>► 228</p>
---	--	--	---	---	--	---

MEGA Double Power Chuck Type D

Flange contacting nut assures highest rigidity. Type D for use with/without coolant-through the tool.

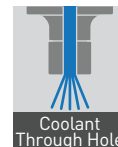

A.3

ø3 - 42mm



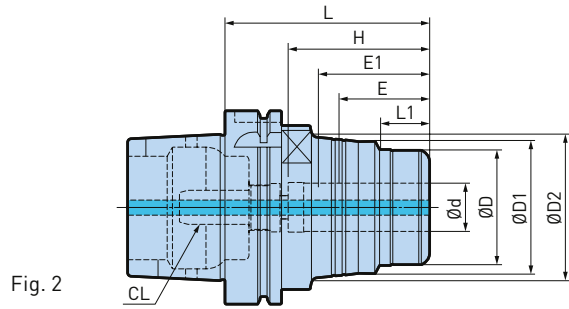
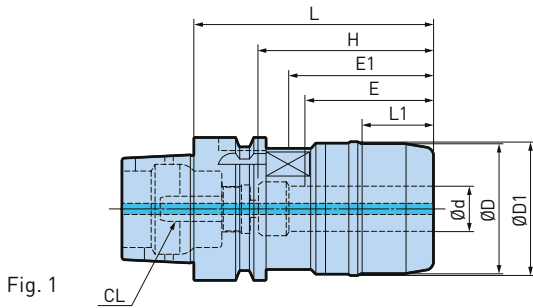



Model	Order No.	Fig.	Ød	ØD	ØD1	ØD2	L	L1	H	E	E1	max. min-1
HSK-A40-MEGA16D-80	803.105	1	16	46	-	-	80	25	62	48	50	12000
HSK-A50-MEGA16D-85	803.085	1	16	46	-	-	85	25	62	48	50	25000
HSK-A50-MEGA20D-85 *	978.011	1	20	50	-	-	86	30	63	50	51	20000
HSK-A63-MEGA16D-80A	803.086	2	16	42	53	-	80	25	55	48	50	25000
HSK-A63-MEGA16D-90A	801.734	2	16	42	53	-	90	25	65	48	55	28000
HSK-A63-MEGA16D-105A	803.087	2	16	42	53	-	105	25	71	48	55	28000
HSK-A63-MEGA16D-135A	801.736	2	16	42	53	-	135	25	71	48	55	24000
HSK-A63-MEGA16D-165A	803.100	2	16	42	53	-	165	25	71	48	55	25000
HSK-A63-MEGA20D-90A	801.737	2	20	50	55	-	90	34	65	50	56	25000
HSK-A63-MEGA20D-105A	803.084	2	20	50	55	-	165	34	80	50	56	23000
HSK-A63-MEGA20D-120A	801.739	2	20	50	55	-	120	34	85	50	56	23000
HSK-A63-MEGA20D-135A	803.079	2	20	50	55	-	105	34	85	50	56	23000
HSK-A63-MEGA20D-165A ****	803.098	2	20	50	55	-	135	34	69 - 79	50	56	23000
HSK-A63-MEGA25D-100A	803.101	1	25	62	63	-	100	39	75	56	57	22000
HSK-A63-MEGA25D-135A ****	803.099	2	25	62	63	-	135	39	66 - 76	56	57	22000
HSK-A63-MEGA32D-105A	803.080	1	32	70	71	-	105	33	80	60	64	22000
HSK-A63-MEGA32D-135A	803.097	2	32	70	71	-	135	33	90	60	64	22000



Model	Order No.	Fig.	Ød	ØD	ØD1	ØD2	L	L1	H	E	E1	max. min-1
HSK-A100-MEGA16D-105	968.132	2	16	46	55	63	105	23	71	48	50	18000
HSK-A100-MEGA16D-135 **	968.055	2	16	46	55	63	135	23	71	48	50	16000
HSK-A100-MEGA16D-165 **	968.056	2	16	46	55	63	165	23	71	48	50	16000
HSK-A100-MEGA20D-105	968.105	2	20	60	69	74	105	25	73	50	56	18000
HSK-A100-MEGA20D-135 ***	968.106	2	20	60	69	74	135	25	85	50	56	16000
HSK-A100-MEGA20D-165 ****	968.107	2	20	60	69	74	165	25	69 - 79	50	56	16000
HSK-A100-MEGA25D-105 *	968.108	2	25	70	77	85	105	32	73	56	65	18000
HSK-A100-MEGA25D-135 ***	968.109	2	25	70	77	85	135	32	90	56	65	16000
HSK-A100-MEGA25D-165 ****	968.110	2	25	70	77	85	165	32	76 - 86	56	65	16000
HSK-A100-MEGA32D-115	968.111	2	32	80	86	-	115	39	83	60	71	18000
HSK-A100-MEGA32D-135	968.112	2	32	80	86	-	135	39	103	60	71	16000
HSK-A100-MEGA32D-165 ***	968.113	2	32	80	86	-	165	39	105	60	71	14000
HSK-A100-MEGA42D-115 *	968.114	2	42	99	100	-	115	40	83	70	71	14000
HSK-A100-MEGA42D-135	968.057	2	42	99	100	-	135	40	97	70	71	12000

1. Wrench and coolant pipe (CL) is to be ordered separately.
2. "E" is the min. clamping length.
3. "E1" is the min. clamping length for optimum use with center through coolant.
4. "H" is the max. tool shank length that can be inserted for these models.
5. * Adjustable straight collet (AC20-) can not be used.
6. **/ *** Commercially available hex socket head screws can be used as a back stop (**=M8 / ***=M12). Coolant is blocked by utilizing these commercial screws.
7. **** Optional axial adjusting screw (HMA-M_) can be used.

Accessories & Spare Parts

PJC Collets	OCA Collets	PSC Collets	C Collets	MEGA Wrenches	Coolant Pipes
					
▶ 347	▶ 348	▶ 348	▶ 349	▶ 351	▶ 228

MEGA Double Power Chuck Type DS

Flange contacting nut assures highest rigidity. Unique coolant supply design ensures efficient coolant supply to the cutting tool periphery.

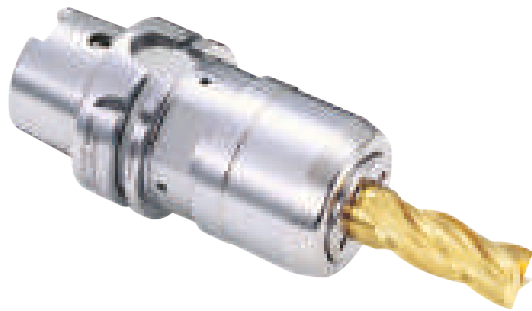
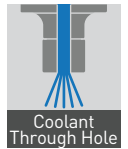

A.3

ø3 - 42mm

Model	Order No.	Fig.	Ød	ØD	ØD1	ØD2	L	L1	H	E	max. min-1
HSK-A40-MEGA16DS-80	803.106	1	16	46	-	-	82.5	28	64	50	12000
HSK-A50-MEGA16DS-85	801.688	1	16	46	-	-	87.5	28	64	50	25000
HSK-A50-MEGA20DS-85	803.088	1	20	50	-	-	88.5	33	65	52	20000
HSK-A63-MEGA16DS-80A	803.089	2	16	42	53	-	82	27	57	50	25000
HSK-A63-MEGA20DS-90A	803.090	2	20	50	55	-	92	36	67	52	25000
HSK-A63-MEGA20DS-120A **	801.740	2	20	50	55	-	122	36	87	52	23000
HSK-A63-MEGA25DS-100A	803.102	1	25	62	-	-	102	41	77	58	22000
HSK-A63-MEGA32DS-105A	803.081	1	32	70	-	-	107.5	35	82	62	22000
HSK-A100-MEGA16DS-105	968.131	2	16	46	55	63	107.5	26	73	50	18000
HSK-A100-MEGA16DS-135 **	968.095	2	16	46	55	63	137.5	26	73	50	16000
HSK-A100-MEGA20DS-105	968.121	2	20	60	69	74	107.5	28	75	52	18000
HSK-A100-MEGA20DS-135 ***	968.122	2	20	60	69	74	137.5	28	87	52	16000
HSK-A100-MEGA20DS-165 ****	968.123	2	20	60	69	74	167.5	28	71 - 81	52	15000
HSK-A100-MEGA25DS-105	968.124	2	25	70	77	85	107.5	34	75	58	18000
HSK-A100-MEGA25DS-135 ***	968.125	2	25	70	77	85	137.5	34	92	58	15000
HSK-A100-MEGA25DS-165 ****	968.126	2	25	70	77	85	167.5	34	78 - 88	58	16000
HSK-A100-MEGA32DS-115	968.127	2	32	80	86	-	117.5	42	85	62	18000
HSK-A100-MEGA32DS-135	968.128	2	32	80	86	-	137.5	42	105	62	16000
HSK-A100-MEGA32DS-165 ***	968.129	2	32	80	86	-	167.5	42	107	62	14000
HSK-A100-MEGA42DS-115 *	968.130	1	42	99	-	-	117	42	85	72	14000

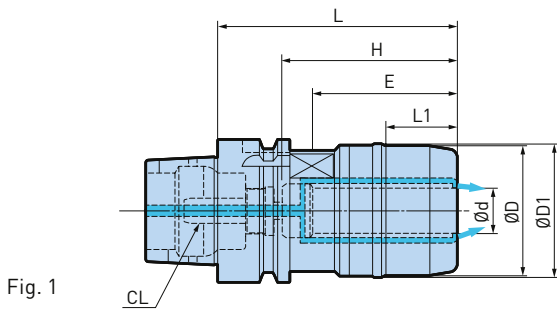

Fig. 1

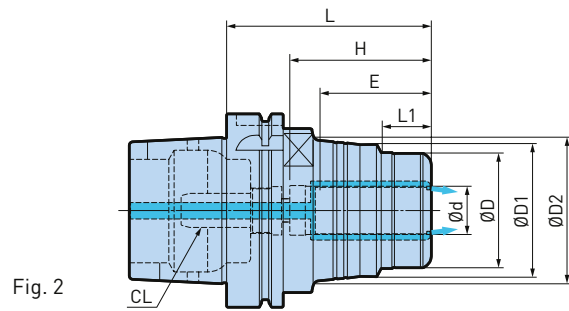

Fig. 2

Model	Order No.	Fig.	Ød	ØD	ØD1	ØD2	L	L1	H	E	max. min-1
HSK-A125-MEGA20DS-135	805.658	2	20	60	69	80	137.5	64.4	87	52	8000
HSK-A125-MEGA20DS-165 ****	805.659	2	20	60	69	79	167.5	124.4	87	52	7000
HSK-A125-MEGA25DS-135	805.660	2	25	70	77	83	137.5	94.4	92	58	8000
HSK-A125-MEGA32DS-135	805.750	2	32	80	86	93	137.5	87.4	92	62	8000
HSK-A125-MEGA32DS-165	805.661	2	32	80	86	93	167.5	117.4	107	62	6000
HSK-A125-MEGA42DS-120	805.662	1	42	99	100	-	122.5	77.7	85	62	7000

1. Wrench and coolant pipe (CL) is to be ordered separately.
2. "E" is the min. clamping length.
3. "H" is the max. tool shank length that can be inserted for these models.
4. * Adjustable straight collet (C42- _+CS) and OCA collet cannot be used.
5. **/** Commercially available hex socket head screws can be used as a back stop (**=M8 /***=M12). Coolant is blocked by utilizing these commercial screws.
6. **** Optional axial adjusting screw (HMA-M_) can be used.

Accessories & Spare Parts

<p>PJC Collets</p>  <p>▶ 347</p>	<p>PSC Collets</p>  <p>▶ 348</p>	<p>C Collets</p>  <p>▶ 349</p>	<p>MEGA Wrenches</p>  <p>▶ 351</p>	<p>Adjusting Screws HMA</p>  <p>▶ 350</p>	<p>Coolant Pipes</p>  <p>▶ 228</p>
---	---	---	---	--	---

MEGA Perfect Grip

100% security against pulling out of the cutting tool under any torque load.

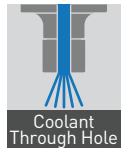

A.3

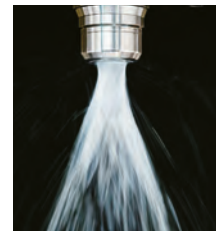
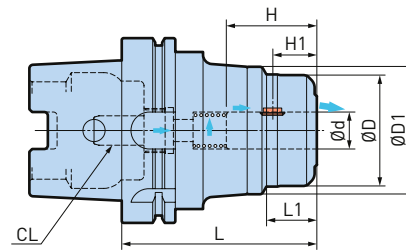

ø16 - 32mm

Model	Order No.	Ød	ØD	ØD1	L	L1	H	H1
HSK-A63-MEGA16DPG-90	806.364	16	46	55	90	24	47	23
HSK-A63-MEGA20DPG-100	806.365	20	60	69	100	27	49	24
HSK-A100-MEGA20DPG-105	805.457	20	60	69	105	27	49	24
HSK-A100-MEGA25DPG-105	805.458	25	70	77	105	33	55	23
HSK-A100-MEGA32DPG-115	805.459	32	80	86	115	41	59	23
HSK-A125-MEGA16DPG-135	807.092	16	46	55	135	24	47	23
HSK-A125-MEGA20DPG-135	806.627	20	60	69	135	27	49	24
HSK-A125-MEGA25DPG-135	806.628	25	70	77	135	33	55	23
HSK-A125-MEGA32DPG-135	806.629	32	80	86	135	41	59	23

1. Key grip and spring are included with each holder.
2. MEGA wrench is to be ordered separately.
3. „H1“ shows distance from center of key grip to front end.
4. Coolant pipe (CL) is to be ordered separately.

Weldon Shank Standards



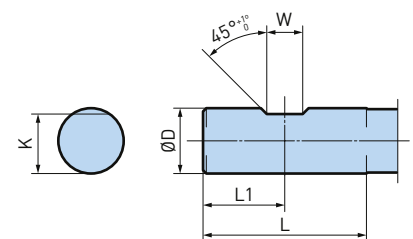
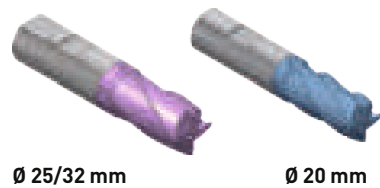

(DIN 1835-1)

The following standard shank is required for MEGA Perfect Grip.

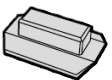

ØD		L	L1	W	K		
Nominal	Tolerance			Nominal	Tolerance	Nominal	Tolerance
16	h6	48	24	10	+0.05 0	14.2	h13
20		50	25	11		18.2	
25		56	32	12		23	
32		60	36	14		30	

Accessories & Spare Parts

Key Grip MEGA Perfect Grip	Spring MEGA Perfect Grip	MEGA Wrenches	Coolant Pipes
			
▶ 350	▶ 350	▶ 351	▶ 228

New Baby Chuck

The original high precision collet chuck to perform all machining applications.

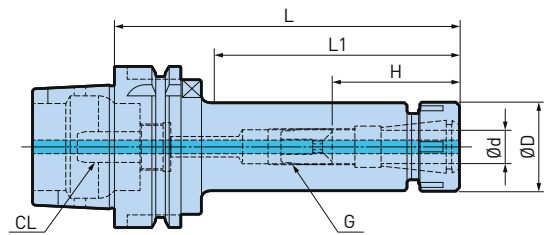
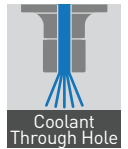

A.3

ø0.25 - 20mm

Model	Order No.	Ød	ØD	L	L1	H	Collet Model	Nut Model
HSK-A63-NBS6-75	968.771	0.25 - 6	20	75	35	20 - 35	NBC6	NBN6
HSK-A63-NBS6-105	968.772	0.25 - 6	20	105	63	20 - 40	NBC6	NBN6
HSK-A63-NBS6-135	968.773	0.25 - 6	20	135	91	20 - 40	NBC6	NBN6
HSK-A63-NBS8-75	968.775	0.5 - 8	25	75	35	23 - 37	NBC8	NBN8
HSK-A63-NBS8-105	968.776	0.5 - 8	25	105	61	23 - 42	NBC8	NBN8
HSK-A63-NBS8-135	968.777	0.5 - 8	25	135	91	23 - 42	NBC8	NBN8
HSK-A63-NBS10-75 *	968.779	1.5 - 10	30	75	35	48	NBC10	NBN10
HSK-A63-NBS10-105	968.780	1.5 - 10	30	105	63	35 - 45	NBC10	NBN10
HSK-A63-NBS10-135	968.781	1.5 - 10	30	135	93	35 - 45	NBC10	NBN10
HSK-A63-NBS13-75 *	968.783	2.5 - 13	35	75	37	48	NBC13	NBN13
HSK-A63-NBS13-105	968.784	2.5 - 13	35	105	67	41 - 55	NBC13	NBN13
HSK-A63-NBS13-135	968.785	2.5 - 13	35	135	97	41 - 60	NBC13	NBN13
HSK-A63-NBS16-75 *	968.787	2.5 - 16	42	75	37	45	NBC16	NBN16
HSK-A63-NBS16-105	968.788	2.5 - 16	42	105	67	45 - 55	NBC16	NBN16
HSK-A63-NBS16-135	968.789	2.5 - 16	42	135	97	45 - 65	NBC16	NBN16
HSK-A63-NBS16-165	968.790	2.5 - 16	42	165	127	45 - 65	NBC16	NBN16
HSK-A63-NBS16-200	968.791	2.5 - 16	42	200	162	45 - 65	NBC16	NBN16
HSK-A63-NBS20-75 *	968.792	2.5 - 20	46	75	39	48	NBC20	NBN20
HSK-A63-NBS20-105	968.793	2.5 - 20	46	105	69	48 - 53	NBC20	NBN20
HSK-A63-NBS20-135	968.794	2.5 - 20	46	135	99	48 - 65	NBC20	NBN20
HSK-A63-NBS20-165	968.795	2.5 - 20	46	165	129	48 - 65	NBC20	NBN20
HSK-A63-NBS20-200	968.796	2.5 - 20	46	200	164	48 - 65	NBC20	NBN20

continues on the next page



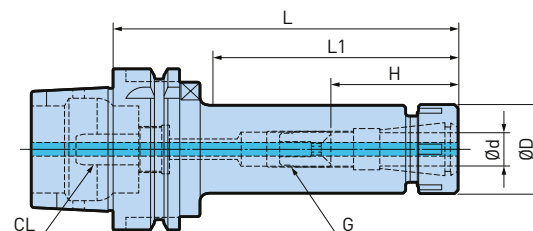

Model	Order No.	Ød	ØD	L	L1	H	Collet Model	Nut Model
HSK-A100-NBS6-120	968.572	0.25 - 6	20	120	68	20 - 40	NBC6	NBN6
HSK-A100-NBS6-165	968.573	0.25 - 6	20	165	113	20 - 40	NBC6	NBN6
HSK-A100-NBS8-120	968.575	0.5 - 8	25	120	73	23 - 42	NBC8	NBN8
HSK-A100-NBS8-165	968.578	0.5 - 8	25	165	113	23 - 42	NBC8	NBN8
HSK-A100-NBS10-120	968.580	1.5 - 10	30	120	73	35 - 45	NBC10	NBN10
HSK-A100-NBS10-165	968.581	1.5 - 10	30	165	113	35 - 45	NBC10	NBN10
HSK-A100-NBS13-120	968.583	2.5 - 13	35	120	73	41 - 60	NBC13	NBN13
HSK-A100-NBS13-165	968.584	2.5 - 13	35	165	113	41 - 60	NBC13	NBN13
HSK-A100-NBS16-120	968.587	• 2.5 - 16	42	120	73	45 - 65	NBC16	NBN16
HSK-A100-NBS16-165	968.588	2.5 - 16	42	165	118	45 - 65	NBC16	NBN16
HSK-A100-NBS20-90 *	968.592	2,5 - 20	46	90	47	56	NBC20	NBN20
HSK-A100-NBS20-120	968.593	• 2.5 - 20	46	120	73	48 - 65	NBC20	NBN20
HSK-A100-NBS20-165	968.594	2.5 - 20	46	165	118	48 - 65	NBC20	NBN20

1. New Baby Nut is included.
2. Coolant pipe (CL) is to be ordered separately.
3. "G" is the adjusting screw (optional).
4. "H" is the max. tool shank length that can be inserted for these models.
5. * Adjusting screws can not be used. "H" is the max. tool shank length that can be inserted for these models.

Accessories & Spare Parts

<p>New Baby Nuts</p>  <p>▶ 334</p>	<p>Baby Perfect Seals</p>  <p>▶ 338</p>	<p>New Baby Collets</p>  <p>▶ 327</p>	<p>New Baby Wrenches</p>  <p>▶ 352</p>	<p>Adjusting Screws NBA</p>  <p>▶ 335</p>	<p>Taper Cleaners</p>  <p>▶ 370</p>	<p>Coolant Pipes</p>  <p>▶ 228</p>
---	--	--	---	---	--	---

New Baby Chuck Type NRA

New Baby Chuck with runout adjustable tool function.

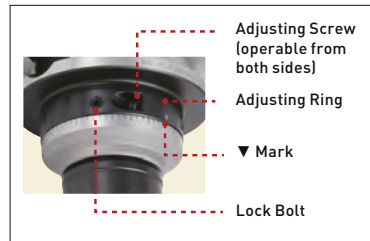

Simple structure for easy adjustment

1. Turn the adjusting ring and line up the ▼ mark with peak runout position.
2. Adjust the lock bolts in 3 locations to fix the ring.
3. The runout amount is adjusted by tightening the adjusting screw.

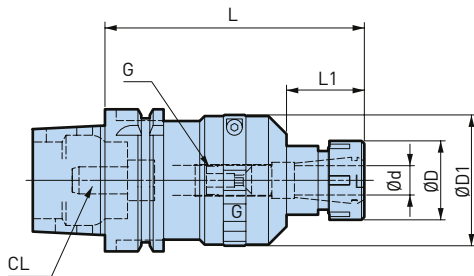

Model	Order No.	Ød	ØD	ØD1	L	L1	H	Collet Model	Nut Model	Adjustment l=50	Adjustment l=100
HSK-A63-NBS8-105NRA	806.266	0.5 - 8	25	45	105	43	23 - 42	NBC8	NBN8	23 µm	34 µm
HSK-A63-NBS13-115NRA	806.267	2.5 - 13	35	58	115	34.5	41 - 60	NBC13	NBN13	18 µm	27 µm
HSK-A63-NBS20-135NRA	806.268	2.5 - 20	46	70	135	45	48 - 65	NBC20	NBN20	17 µm	25 µm

1. Coolant pipe (CL) is to be ordered separately.
2. Nut is included.
3. Collet, wrench and adjusting screw need to be ordered separately.
4. "H" is the max. tool shank length that can be inserted for these models.
5. The adjustment amount depends on the length of the holder and the tool projection length. The maximum adjustment amount for tool projection lengths of 50 mm and 100 mm is shown in the table.

Accessories & Spare Parts

<p>New Baby Nuts</p> <p>▶ 334</p>	<p>New Baby Collets</p> <p>▶ 327</p>	<p>Coolant Pipes</p> <p>▶ 228</p>	<p>New Baby Wrenches</p> <p>▶ 352</p>	<p>Baby Perfect Seals</p> <p>▶ 338</p>	<p>Adjusting Screws NBA</p> <p>▶ 335</p>
--	---	--	--	---	---

New Hi-Power Milling Chuck Type S

The original design assures heavy milling with high power and precision.



A.3

ø3 - 42mm

Model	Order No.	Fig.	Ød	ØD	L	L1	L2	H	E	E1
HSK-A40-HMC20S-85	805.100	1	20	50	85	65	-	66	50	56
HSK-A50-HMC20S-90	805.101	1	20	50	90	64	-	66	50	56
HSK-A50-HMC32S-115 ****	806.595	1	32	62	115	89	-	69	56	58
HSK-A63-HMC20S-90	965.511S	1	20	50	90	64	-	65	50	56
HSK-A63-HMC20S-120 **	805.102	1	20	50	120	94	-	85	50	56
HSK-A63-HMC25S-100	968.136S	1	25	59	100	74	-	75	56	57
HSK-A63-HMC25S-135 *	805.103	1	25	59	135	109	-	66 - 76	56	57
HSK-A63-HMC32S-110	968.137S	1	32	68	110	84	-	85	60	64
HSK-A63-HMC32S-135 **	805.104	1	32	68	135	109	-	90	60	64
HSK-A63-HMC32S-165 *	805.105	1	32	68	165	139	-	79 - 89	60	64

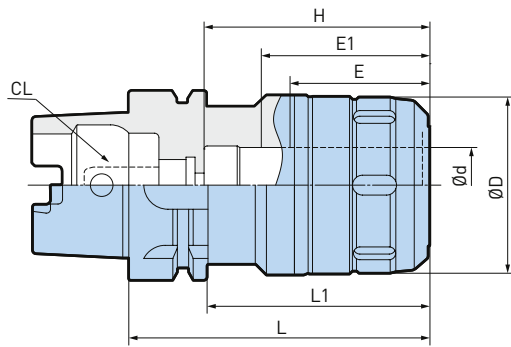

Fig. 1

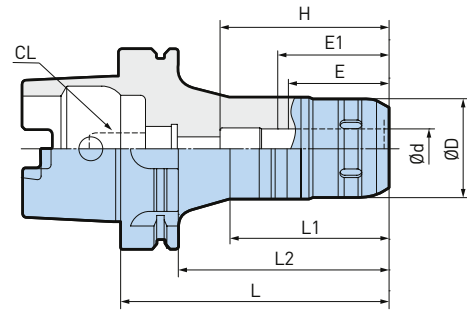

Fig. 2

Model	Order No.	Fig.	Ød	ØD	L	L1	L2	H	E	E1
HSK-A100-HMC20S-105	805.106	1	20	50	105	76	-	73	50	56
HSK-A100-HMC20S-135 ***	805.107	2	20	50	135	80	106	85	50	56
HSK-A100-HMC20S-165 *	805.108	2	20	50	165	100	136	69 - 79	50	56
HSK-A100-HMC25S-105 *****	805.110	1	25	59	105	76	-	73	56	57
HSK-A100-HMC25S-135 ***	804.917	1	25	59	135	106	-	90	56	57
HSK-A100-HMC25S-165 *	805.111	2	25	59	165	105	136	76 - 86	56	57
HSK-A100-HMC32S-115	805.112	1	32	68	115	86	-	83	60	72
HSK-A100-HMC32S-135	805.113	1	32	68	135	106	-	103	60	72
HSK-A100-HMC32S-165 ***	805.114	2	32	68	165	105	136	105	60	72
HSK-A100-HMC32S-200 *	805.115	2	32	68	200	130	171	90 - 100	60	72
HSK-A100-HMC32S-300	805.116	1	32	68	300	200	271	90 - 100	60	72
HSK-A100-HMC42S-115 *****	805.117	1	42	85	115	86	-	83	70	73
HSK-A100-HMC42S-135	805.118	1	42	85	135	106	-	103	70	73
HSK-A100-HMC42S-165 ***	805.119	1	42	85	165	136	-	107	70	73

1. Wrench and coolant pipe (CL) is to be ordered separately.
2. "E1" is the min. clamping length for optimum use with center through coolant.
3. "E" is the min. clamping length.
4. "H" is the max. tool shank length that can be inserted for these models.
5. * Axial length adjusting screw can be used.
 / * Commercially available hex socket head screws can be used as a back stop (**=M8/***=M12). Coolant is blocked by utilizing these commercial screws.
6. **** Only the straight collet (C32-) can be used.
7. ***** Adjustable straight collet (C25- +CS) cannot be used.
8. ***** Only OCA collet and C collet can be used.

Accessories & Spare Parts

PJC Collets	OCA Collets	PSC Collets	C Collets	FK Wrenches	Adjusting Screws HMA	Coolant Pipes
						
▶ 347	▶ 348	▶ 348	▶ 349	▶ 352	▶ 350	▶ 228

New Hi-Power Milling Chuck HMC12J

Extremely slim and rigid design with jet through coolant.

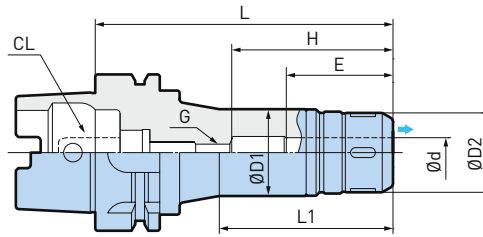



A.3

ø6 - 12mm

Model	Order No.	Ød	ØD1	ØD2	L	L1	H	E	G
HSK-A63-HMC12J-90	805.829	12	35	32	90	52	65	43	M8
HSK-A63-HMC12J-120 *	805.830	12	35	32	120	70	65	43	M8

1. Wrench and coolant pipe (CL) is to be ordered separately.
2. "E" is the min. clamping length.
3. * Hex socketed head screw (M8) can be used as an adjusting screw.

Accessories & Spare Parts

PJC Collets	FK Wrenches	Coolant Pipes
		
▶ 347	▶ 352	▶ 228

New Hi-Power Milling Chuck Type NRA

The runout adjustment design assures precision even with heavy milling.

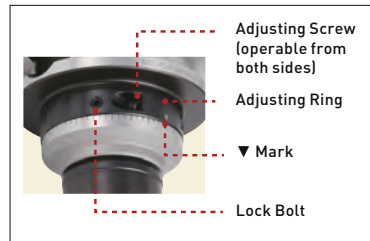

Simple structure for easy adjustment

1. Turn the adjusting ring and line up the ▼ mark with peak runout position.
2. Adjust the lock bolts in 3 locations to fix the ring.
3. The runout amount is adjusted by tightening the adjusting screw.

A.3

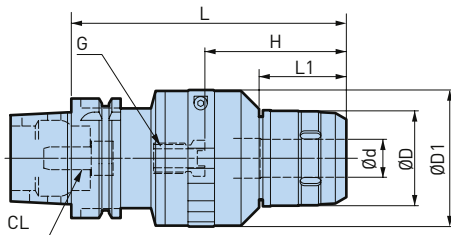

ø20 - 32mm

Model	Order No.	Ød	ØD	ØD1	L	L1	H	Adjustment l=50	Adjustment l=100
HSK-A63-HMC20S-145NRA	806.273	20	50	72	145	46	69 - 79	23 µm	33 µm
HSK-A63-HMC32S-155NRA *	806.274	32	68	86	155	55	-	20 µm	28 µm

1. Coolant pipe (CL) is to be ordered separately.
2. "H" is the max. tool shank length that can be inserted for these models.
3. Wrench and axial adjusting screw are to be ordered separately.
4. * Adjusting screw cannot be used.

Accessories & Spare Parts

FK Wrenches	C Collets	OCA Collets	PSC Collets	PJC Collets	Adjusting Screws HMA	Coolant Pipes
▶ 352	▶ 349	▶ 348	▶ 348	▶ 347	▶ 350	▶ 228

Hydraulic Chuck Super Slim

Ultra precise hydraulic chuck with extremely slim design.

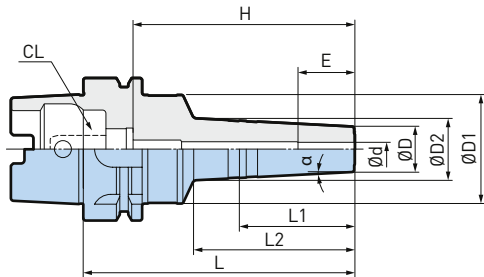

Fig. 2

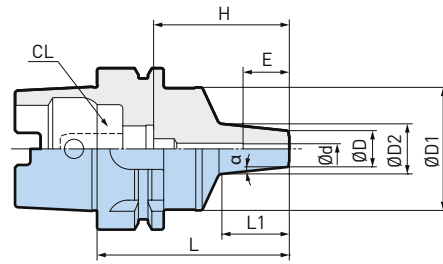

Fig. 1

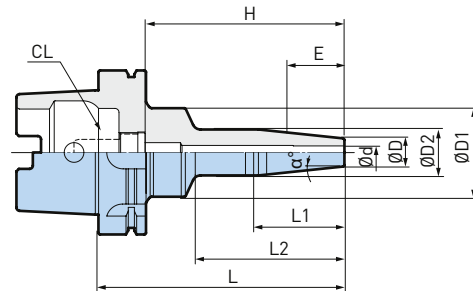

Fig. 3

ø4 - 12mm

Model	Order No.	Fig.	Ød	ØD	ØD1	ØD2	L	L1	L2	H	E	α
HSK-A40-HDC4S-65	805.527	1	4	14	33	21	65	28	-	49	19	6°
HSK-A50-HDC4S-75	805.548	1	4	14	40	21	75	31	-	55	19	6°
HSK-A63-HDC3S-90 *	805.465	1	3	14	48	24	90	43	-	68	16	6°
HSK-A63-HDC3S-120 *	807.788	2	3	14	48	26	120	57	72	98	16	6°
HSK-A63-HDC4S-75	803.072	1	4	14	48	20	75	26	-	53	19	6°
HSK-A63-HDC4S-90	807.373	1	4	14	48	23	90	43	-	68	19	6°
HSK-A63-HDC4S-120	805.466	2	4	14	48	26	120	57	72	98	19	6°
HSK-A63-HDC5S-120	807.374	2	5	14	48	26	120	57	72	98	22	6°
HSK-A63-HDC6S-120	803.073	2	6	14	48	26	120	57	70	98	25	6°
HSK-A63-HDC6S-150	805.467	2	6	14	48	26	150	57	85	128	25	6°
HSK-A63-HDC8S-120	803.074	2	8	17	48	28	120	52	70	95	31	6°
HSK-A63-HDC8S-150	805.468	2	8	17	48	28	150	52	85	125	31	6°
HSK-A63-HDC10S-120	803.070	2	10	19	48	30	120	52	70	94	33	6°
HSK-A63-HDC10S-150	805.469	2	10	19	48	30	150	52	87	124	33	6°
HSK-A63-HDC12S-120	803.071	2	12	21	48	32	120	52	70	93	36	6°
HSK-A63-HDC12S-150	805.470	2	12	21	48	32	150	52	87	123	36	6°
HSK-A100-HDC4S-150	100108.002.0	3	4	14	52	26	150	57	90	121	19	6°
HSK-A100-HDC6S-150	100108.003.0	3	6	14	52	26	150	57	90	121	25	6°
HSK-A100-HDC8S-150	100108.004.0	3	8	17	54	28	150	52	90	121	31	6°
HSK-A100-HDC10S-150	100108.005.0	3	10	19	56	30	150	52	90	121	33	6°
HSK-A100-HDC12S-150	100108.006.0	3	12	21	58	32	150	52	90	115	36	6°

1. Adjusting screw and reduction collet can not be used.
2. Coolant pipe [CL] is to be ordered separately.
3. "E" is the min. clamping length.
4. "H" is the max. tool shank length that can be inserted for these models.
5. * Some coolant may leak from the inner diameter slits when using coolant.

Caution

- Use only cutting tools that have a shank tolerance within h6.
- Roughing endmills are not recommended for use with hydraulic chucks.
- Do not use with cutting tools made with a flat on the shank. (ie: Weldon type shank)
- Do not tighten the clamping screw without first inserting a cutting tool into the hydraulic chuck.
- Always insert the cutting tool into the hydraulic chuck beyond min. clamping length E.

Accessories & Spare Parts

<p>Wiper Cleaners</p> <p>► 370</p>	<p>Coolant Pipes</p> <p>► 228</p>
------------------------------------	-----------------------------------

Hydraulic Chuck Jet Through

Coolant or MQL is supplied to cutting edge securely. Maximum performance in high-precision operations with 5-axis machining.

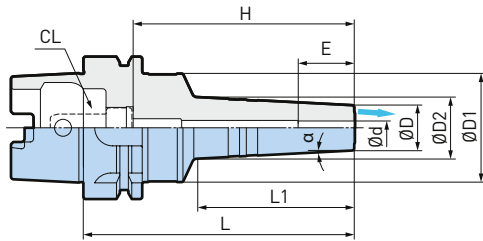
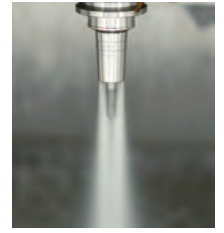
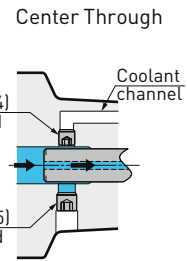
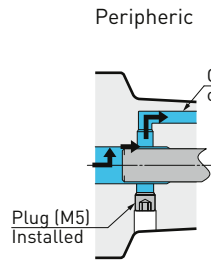
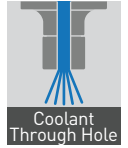

Fig. 1

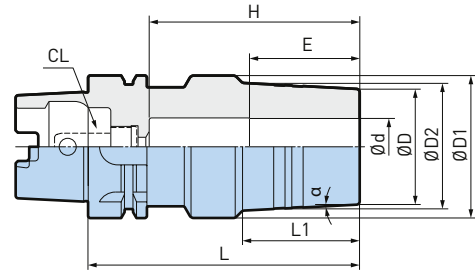

Fig. 2

Ø4 - 32mm

Model	Order No.	Fig.	Ød	ØD	ØD1	ØD2	L	L1	H	E	α
HSK-A63-HDC4J-75	805.477	1	4	20	48	23	75	29	53	19	3°
HSK-A63-HDC6J-120	805.096	1	6	20	48	28	120	70	98	25	3°
HSK-A63-HDC8J-120	805.097	1	8	22	48	30	120	70	95	31	3°
HSK-A63-HDC10J-120	805.098	1	10	24	48	32	120	70	94	33	3°
HSK-A63-HDC12J-120	805.099	1	12	26	48	34	120	70	93	36	3°
HSK-A63-HDC16J-120	805.478	1	16	34	48	43	120	76	92	43	3°
HSK-A63-HDC20J-120	805.479	1	20	38	48	43	120	76	91	43	3°
HSK-A63-HDC25J-120	805.831	2	25	51	63	57	120	50	93	49	3°
HSK-A63-HDC32J-120	805.832	2	32	60	69	-	120	53	93	56	3°

1. Adjusting screw cannot be used.
2. Straight collet can be used for HDC16J & 20J size models.
3. Coolant pipe (CL) is to be ordered separately.
4. Larger diameter models, HDC16J, 20J, 25J, 32J are available with only peripheral coolant supply.
5. "E" is the min. clamping length.
6. "H" is the max. tool shank length that can be inserted for these models.

Caution

- Use only cutting tools that have a shank tolerance within h6.
- Roughing endmills are not recommended for use with hydraulic chucks.
- Do not use with cutting tools made with a flat on the shank. (ie: Weldon type shank)
- Do not tighten the clamping screw without first inserting a cutting tool into the hydraulic chuck.
- Always insert the cutting tool into the hydraulic chuck beyond min. clamping length E.

Accessories & Spare Parts

PJC Collets	PSC Collets	Wiper Cleaners	Coolant Pipes
			
▶ 347	▶ 348	▶ 370	▶ 228

Hydraulic Chuck Standard

For high precision machining in automotive, aerospace, medical and die & mold.

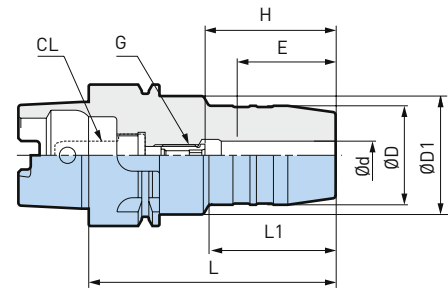
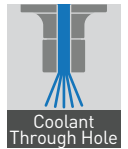

Fig. 1

Ø3 - 32mm

Model	Order No.	Fig.	Ød	ØD	ØD1	L	L1	H	E	G
HSK-A40-HDC6-70	803.044	1	6	26	34	70	36	28 - 36	28	HDA 6-05013
HSK-A40-HDC8-70	803.046	1	8	28	34	70	36	28 - 36	28	HDA 8-06013
HSK-A40-HDC10-75	803.048	1	10	30	34	75	41	33 - 41	33	HDA 8-06013
HSK-A40-HDC12-80	803.050	1	12	32	34	80	46	38 - 45	38	HDA 8-06013
HSK-A50-HDC6-75	801.177	1	6	26	42	75	32	28 - 37	28	HDA 6-05013
HSK-A50-HDC8-75	801.178	1	8	28	42	75	32	28 - 37	28	HDA 8-06013
HSK-A50-HDC10-80	801.172	1	10	30	42	80	37	33 - 41	33	HDA 10-08015
HSK-A50-HDC12-85	801.173	1	12	32	42	85	42	38 - 46	38	HDA 10-08015
HSK-A50-HDC16-90 **	801.174	1	16	38	42	90	48	43 - 51	43	HDA 10-08015
HSK-A50-HDC20-90 **	801.175	1	20	42	-	90	64	43 - 51	43	HDA 10-08015
HSK-A50-HDC25-90 *	801.176	1	25	55	63	90	23	62	52	-
HSK-A63-HDC6-70 *	801.222	2	6	26	50	70	24	46	28	-
HSK-A63-HDC6-120	978.402	2	6	26	50	120	44	28 - 48	28	HDA 6-05032
HSK-A63-HDC6-150	801.221	2	6	26	50	150	44	28 - 48	28	HDA 6-05033
HSK-A63-HDC7-120	801.223	2	7	27	50	120	44	28 - 48	28	HDA 6-05032
HSK-A63-HDC8-70 *	801.227	2	8	28	50	70	24	46	28	-
HSK-A63-HDC8-120	979.202	2	8	28	50	120	44	28 - 48	28	HDA 8-06032
HSK-A63-HDC8-150	801.226	2	8	28	50	150	44	28 - 48	28	HDA 8-06032
HSK-A63-HDC9-120	801.228	2	9	29	50	120	44	28 - 48	28	HDA 8-06032
HSK-A63-HDC10-80 *	801.196	2	10	30	50	80	35	55	33	-
HSK-A63-HDC10-120	979.203	2	10	30	50	120	45	33 - 53	33	HDA 10-08032
HSK-A63-HDC10-150	801.195	2	10	30	50	150	45	33 - 53	33	HDA 10-08032
HSK-A63-HDC11-120	801.197	2	11	31	50	120	45	33 - 53	38	HDA 10-08032
HSK-A63-HDC12-85 *	801.201	2	12	32	50	85	40	60	33	-
HSK-A63-HDC12-120	979.204	2	12	32	50	120	45	38 - 58	38	HDA 12-10025
HSK-A63-HDC12-150	801.200	2	12	32	50	150	45	38 - 58	38	HDA 12-10025
HSK-A63-HDC13-120	801.202	2	13	33	50	120	45	38 - 58	38	HDA 12-10025
HSK-A63-HDC14-85 *	801.207	2	14	34	50	85	40	60	38	-
HSK-A63-HDC14-120	801.205	2	14	34	50	120	45	38 - 58	38	HDA 12-10026
HSK-A63-HDC14-150	801.206	2	14	34	50	150	45	38 - 58	38	HDA 12-10025
HSK-A63-HDC15-120	801.208	2	15	37	50	120	45	58 - 68	43	HDA 16-12015
HSK-A63-HDC16-90 *	801.212	2	16	38	50	90	46	65	43	-
HSK-A63-HDC16-120	978.404	2	16	38	50	120	46	58 - 68	43	HDA 16-12016
HSK-A63-HDC16-150	801.211	2	16	38	50	150	46	43 - 68	43	HDA 16-12037
HSK-A63-HDC18-90 *	801.215	2	18	40	50	90	46	65	43	-
HSK-A63-HDC18-120	801.213	2	18	40	50	120	46	58 - 68	43	HDA 20-16015
HSK-A63-HDC18-150	801.214	2	18	40	50	150	46	43 - 68	43	HDA 25-16039
HSK-A63-HDC20-90 *	801.217	2	20	42	50	90	48	65	43	-
HSK-A63-HDC20-120	979.206	2	20	42	50	120	48	58 - 68	43	HDA 20-16015
HSK-A63-HDC20-150	801.216	2	20	42	50	150	48	43 - 68	43	HDA 25-16039
HSK-A63-HDC25-120 *	801.218	3	25	55	50	120	51	95	52	-
HSK-A63-HDC31-95	806.444	3	31	63	74	95	27	70	56	-
HSK-A63-HDC32-125 *	801.219	3	32	60	69	125	59	100	56	-

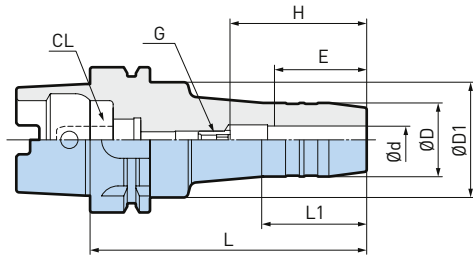

Fig. 2

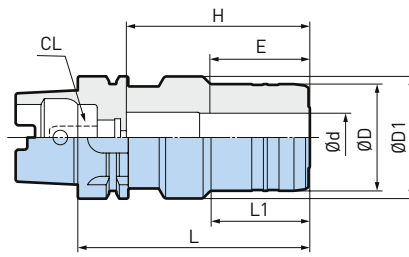

Fig. 3

Model	Order No.	Fig.	Ød	ØD	ØD1	L	L1	H	E	G
HSK-A100-HDC6-75 *	801.142	1	6	26	50	75	26	46	28	-
HSK-A100-HDC6-120	801.140	1	6	26	50	120	44	28 - 48	28	HDA 6-05032
HSK-A100-HDC6-165	801.141	1	6	26	50	165	44	28 - 48	28	HDA 6-05032
HSK-A100-HDC8-75 *	801.145	1	8	28	50	75	26	46	28	-
HSK-A100-HDC8-120	801.143	1	8	28	50	120	44	28 - 48	28	HDA 8-06032
HSK-A100-HDC8-165	801.144	1	8	28	50	165	44	28 - 48	28	HDA 8-06032
HSK-A100-HDC10-90 *	801.128	1	10	30	50	90	42	61	33	-
HSK-A100-HDC10-120	801.126	1	10	30	50	120	45	33 - 53	33	HDA 10-08032
HSK-A100-HDC10-165	801.127	1	10	30	50	165	45	33 - 53	33	HDA 10-08032
HSK-A100-HDC12-95 *	801.131	1	12	32	50	95	47	63	38	-
HSK-A100-HDC12-120	801.129	1	12	32	50	120	47	38 - 58	38	HDA 12-10025
HSK-A100-HDC12-165	801.130	1	12	32	50	165	47	38 - 58	38	HDA 12-10032
HSK-A100-HDC16-100 *	801.132	1	16	38	50	100	53	68	43	-
HSK-A100-HDC16-135	801.133	1	16	38	50	135	53	43 - 68	43	HDA 16-12030
HSK-A100-HDC16-165	801.134	1	16	38	50	165	53	43 - 68	43	HDA 16-12037
HSK-A100-HDC20-105 *	801.135	1	20	42	50	105	59	73	43	-
HSK-A100-HDC20-135	801.136	1	20	42	50	135	59	58 - 68	43	HDA 20-16015
HSK-A100-HDC20-165	801.137	1	20	42	50	165	59	43 - 68	43	HDA 25-16039
HSK-A100-HDC25-110 *	801.138	1	25	55	63	110	62	78	52	-
HSK-A100-HDC32-110 *	801.139	1	32	64	75	110	62	78	56	-

1. Coolant pipe (CL) is to be ordered separately.
2. * Adjusting screw cannot be used.
3. ** Straight collet can not be used.
4. "E" is the min. clamping length.
5. "G" is the adjusting screw (optional).
6. "H" is the max. tool shank length that can be inserted for these models.

Caution

- Use only cutting tools that have a shank tolerance within h6.
- Roughing endmills are not recommended for use with hydraulic chucks.
- Do not use with cutting tools made with a flat on the shank. (ie: Weldon type shank)
- Do not tighten the clamping screw without first inserting a cutting tool into the hydraulic chuck.
- Always insert the cutting tool into the hydraulic chuck beyond min. clamping length E.

Accessories & Spare Parts

<p>PJC Collets</p>  <p>▶ 347</p>	<p>PSC Collets</p>  <p>▶ 348</p>	<p>Adjusting Screws HDA</p>  <p>▶ 354</p>	<p>Wiper Cleaners</p>  <p>▶ 370</p>	<p>Coolant Pipes</p>  <p>▶ 228</p>
---	---	--	--	---

Mold Chuck

Slim and tapered design reduces outer diameter and improves stability. Ideal for machining moulds with weldon tools.

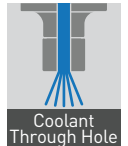

A.3

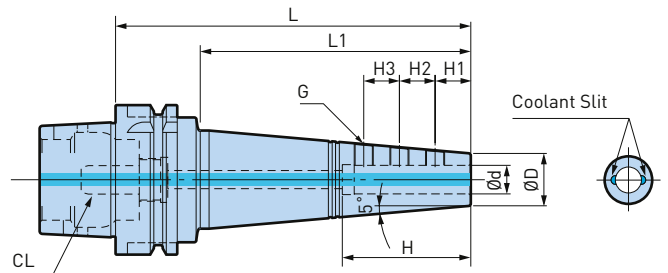

ø3 - 20mm

Model	Order No.	Ød	ØD	L	L1	H	H1	H2	H3	G
HSK-A63-SSL3-135	801.269	3	10	135	99	113	6	6	-	M3
HSK-A63-SSL4-135	801.270	4	11	135	99	113	6	7	-	M4
HSK-A63-SSL6-135	978.020	6	13	135	99	113	12	13	-	M6
HSK-A63-SSL8-135	978.021	8	15	135	99	40	13,5	18	-	M6
HSK-A63-SSL10-150	978.022	10	17	150	114	48	15	20	-	M6
HSK-A63-SSL12-150	978.023	12	22	150	115	60	15	16	16	M8
HSK-A63-SSL16-150	978.024	16	26	150	115	70	15	20	22	M8
HSK-A100-SSL8-150	806.830	8	15	150	111	121	13,5	18	-	M6
HSK-A100-SSL10-150	806.831	10	17	150	111	121	15	20	-	M6
HSK-A100-SSL12-150	806.832	12	22	150	111	60	15	16	16	M8
HSK-A100-SSL12-200	806.833	12	22	200	161	60	15	16	16	M8
HSK-A100-SSL16-150	806.834	16	26	150	110	65	15	20	22	M8
HSK-A100-SSL16-200	806.835	16	26	200	160	65	15	20	22	M8
HSK-A100-SSL20-150	806.836	20	30	150	110	80	15	25	25	M8
HSK-A100-SSL20-200	806.837	20	30	200	160	80	15	25	25	M8

1. Coolant pipe (CL) is to be ordered separately.
2. Only 2 flute ball endmill with weldon shank is to be used.

Accessories & Spare Parts

<p>Mold Chuck Clamping Screw</p>  <p>► 366</p>	<p>Coolant Pipes</p>  <p>► 228</p>
---	---

Shrink Chuck Slim

Slim design reduces interference contours.

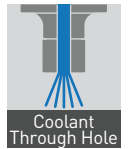

A.3

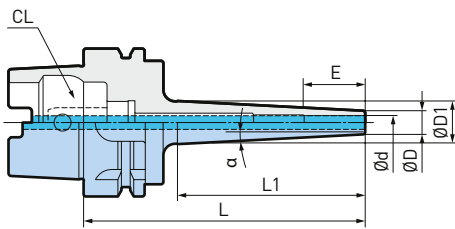

Fig. 1

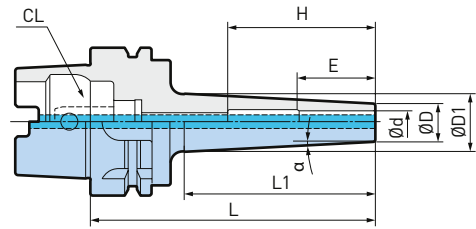

Fig. 2

ø6 - 12mm

Model	Order No.	Fig.	Ød	ØD	ØD1	L	L1	H	E	α
HSK-A63-SRC6S-120	801.264	1	6	10	19	120	81	(98)	26	3°
HSK-A63-SRC6S-165	801.265	1	6	10	23	165	121	(143)	26	3°
HSK-A63-SRC8S-120	801.267	2	8	13	22	120	81	(98)	26	3°
HSK-A63-SRC8S-165	801.268	2	8	13	26	165	123	(143)	26	3°
HSK-A63-SRC10S-120	801.253	2	10	16	25	120	81	62	32	3°
HSK-A63-SRC10S-165	801.254	2	10	16	29	165	123	62	32	3°
HSK-A63-SRC12S-120	801.256	2	12	19	28	120	81	72	36	3°
HSK-A63-SRC12S-165	801.257	2	12	19	32	165	125	72	36	3°

1. Use carbide cutter within a tolerance of h6.
2. Coolant pipe [CL] is to be ordered separately.
3. "E" is the min. clamping length.
4. "H" dimensions in () are reference length up to the coolant pipe.
5. Please refer to the operation manual of heating / cooling equipment, as some equipment may not be compatible.

Accessories & Spare Parts

<p>Wiper Cleaners</p> <p>► 370</p>	<p>Coolant Pipes</p> <p>► 228</p>
------------------------------------	-----------------------------------

Shrink Chuck Standard

Stable body provides high rigidity.

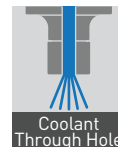

A.3

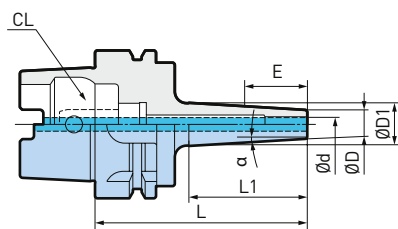

Fig. 1

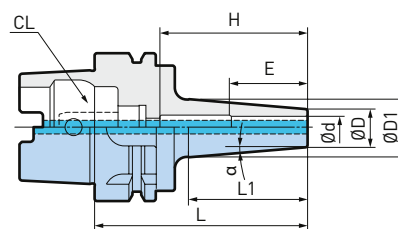

Fig. 2

ø4 - 20mm

Model	Order No.	Fig.	Ød	ØD	ØD1	L	L1	H	E	α
HSK-A63-SRC4-90 *	801.262	1	4	10	15	90	46	(68)	16	3°
HSK-A63-SRC6-90	978.295	1	6	14	20	90	51	(68)	26	3°
HSK-A63-SRC6-150	801.263	1	6	14	26	150	108	(128)	26	3°
HSK-A63-SRC8-90	978.296	2	8	18	24	90	51	(68)	26	3°
HSK-A63-SRC8-150	801.266	2	8	18	30	150	110	(128)	26	3°
HSK-A63-SRC10-90	978.297	2	10	22	28	90	51	62	32	3°
HSK-A63-SRC10-150	801.252	2	10	22	34	150	111	62	32	3°
HSK-A63-SRC12-90	978.298	2	12	24	30	90	51	65	36	3°
HSK-A63-SRC12-150	801.255	2	12	24	36	150	112	72	36	3°
HSK-A63-SRC16-90	978.299	2	16	28	34	90	51	65	38	3°
HSK-A63-SRC16-165	801.258	2	16	28	41	165	119	80	38	3°
HSK-A63-SRC20-90	801.260	2	20	34	40	90	53	65	42	3°
HSK-A63-SRC20-165	801.259	2	20	34	47	165	122	100	42	3°

- * Use carbide cutter within a tolerance of h5.
- Use carbide cutter within a tolerance of h6.
- "H" dimensions in () are reference length up to the coolant pipe.
- "E" is the min. clamping length.
- Coolant pipe (CL) is to be ordered separately.
- Please refer to the operation manual of heating / cooling equipment, as some equipment may not be compatible.

Accessories & Spare Parts

<p>Wiper Cleaners</p> <p>► 370</p>	<p>Coolant Pipes</p> <p>► 228</p>
------------------------------------	-----------------------------------

CK Shanks with Center Through Coolant

With drive key grooves and orientation notch.

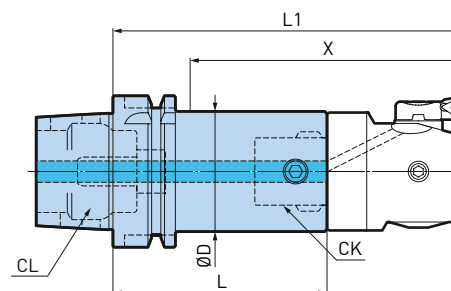
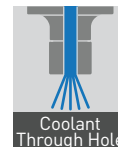

A.3

CK1-CK7

Model	Order No.	CK	ØD	L	L1	X
HSK-A25-CKB2-30 *	328.279F	CKB2	24	30	66	50
HSK-A32-CKB2-33	328.278F	CKB2	24	33	69	43
HSK-A40-CKB1-32	324.112F	CKB1	19	31.5	64	40
HSK-A40-CKB2-35	328.277F	CKB2	24	35	71	45
HSK-A40-CKB3-40	324.132F	CKB3	31	40	80	55
HSK-A40-CKB4-50	324.142F	CKB4	39	50	97	72
HSK-A50-CKB3-44	324.232F	CKB3	31	44	84	53
HSK-A50-CKB4-48	324.242F	CKB4	39	48	95	64
HSK-A50-CKB5-61	324.252F	CKB5	50	61	118	87
HSK-A63-CKB1-79	324.312F	CKB1	19	78.5	111	80
HSK-A63-CKB2-96	324.322F	CKB2	24	95.5	131	100
HSK-A63-CKB3-71	324.331	CKB3	31	71	111	80
HSK-A63-CKB3-71FB	324.331F	CKB3	31	71	111	80
HSK-A63-CKB3-121	324.332	CKB3	31	121	161	130
HSK-A63-CKB4-94	324.341	CKB4	39	94	141	110
HSK-A63-CKB4-94FB	324.341F	CKB4	39	94	141	110
HSK-A63-CKB4-114	324.342	CKB4	39	114	161	130
HSK-A63-CKB5-59	324.352	CKB5	50	59	116	85
HSK-A63-CKB5-59FB	324.352F	CKB5	50	59	116	85
HSK-A63-CKB5-89	324.353	CKB5	50	89	146	115
HSK-A63-CKB5-134	324.354	CKB5	50	134	191	160
HSK-A63-CKN6-70	324.361N	CKN6	63.5	70	141	110
HSK-A63-CKB6-70	324.361	CKB6	63.5	70	141	110
HSK-A63-CKB6-70FB	324.361F	CKB6	63.5	70	141	110
HSK-A63-CKB6-100	324.362	CKB6	63.5	100	171	140
HSK-A63-CKN6-160	324.367N	CKN6	63.5	160	231	200
HSK-A80-CKB6-75	324.461	CKB6	63.5	75	146	115

continues on the next page



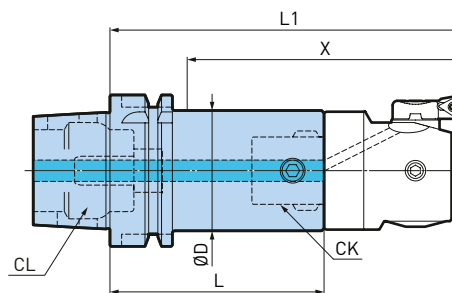

Model	Order No.	CK	ØD	L	L1	X
HSK-A100-CKB3-124	324.531	CKB3	31	124	164	130
HSK-A100-CKB4-147	324.541	CKB4	39	147	194	160
HSK-A100-CKB5-107	324.551	CKB5	50	107	164	130
HSK-A100-CKB5-177	324.552	CKB5	50	177	234	200
HSK-A100-CKB6-78	324.561	CKB6	63.5	78	149	115
HSK-A100-CKN6-78	324.561N	CKN6	63.5	78	149	115
HSK-A100-CKB6-108	324.563	CKB6	63.5	108	179	145
HSK-A100-CKN6-108	324.563N	CKN6	63.5	108	179	145
HSK-A100-CKN6-223	324.566N	CKN6	63.5	223	294	260
HSK-A100-CKB7-87	324.571	CKB7	90	87	204 (174)	170 (140)
HSK-A100-CKN7-87	324.571N	CKN7	90	87	204 (174)	170 (140)
HSK-A100-CKB7-127	324.572	CKB7	90	127	244 (214)	210 (180)
HSK-A100-CKN7-127	324.572N	CKN7	90	127	244 (214)	210 (180)
HSK-A100-CKN7-267	324.575N	CKN7	90	267	384 (354)	350 (320)
HSK-A125-CKB6-94	869.024	CKB6	63.5	94	165	125
HSK-A125-CKB7-123	869.025	CKB7	90	123	240 (210)	195 (165)

1. X and L1 dimensions on the table are reference figures when EWN/EWE head is mounted.
2. HSK shanks with index "FB" are precision balanced.
3. Coolant pipe (CL) is to be ordered separately.
4. () Indicate the length when short version of EWN (EWN100-203CKB7-87) is mounted.
5. * Without ID bore

Accessories & Spare Parts

<p>Coolant Pipes</p>  <p>► 228</p>	<p>Fine Boring Heads</p>  <p>► 396-399</p>
---	---

Smart Damper CK Shanks

Tool shanks with integrated damping system for highly efficient deep hole fine boring.

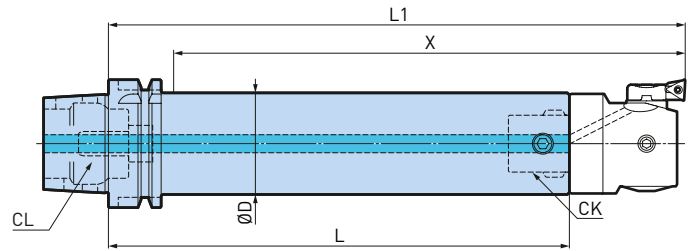
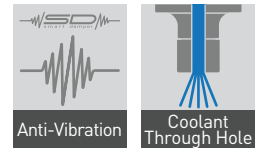

A.3

Model	Order No.	CK	ØD	L	L1	X
HSK-A100-CKB4DP-241	807.546	CKB4	39	241	288	246
HSK-A100-CKB5DP-303	328.238	CKB5	50	303	360	318
HSK-A100-CKB6DP-379	328.240	CKB6	64	379	450	408

1. X and L1 dimensions on the table are reference figures when EWN/EWE head is mounted.
2. Coolant pipe (CL) is to be ordered separately.

Accessories & Spare Parts

Coolant Pipes	Fine Boring Heads
 <p>► 228</p>	 <p>► 396-399</p>

Face Mill Arbors Type FMH

For milling heads that require a coolant bore in the face .

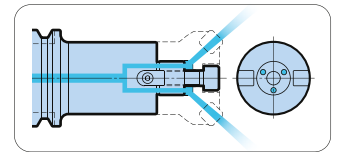
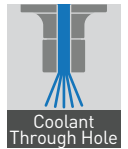

A.3

Model	Order No.	Fig.	ØD	ØD1	L	L1	L2	W	G	ØC min.
HSK-A50-FMH22-47-60	805.833	2	22	47	60	18	5	10	M10	36
HSK-A50-FMH27-60-60	805.834	2	27	60	60	20	6	12	M12	46
HSK-A63-FMH16-37-45	979.194	1	16	37	45	16	5	8	M8	28
HSK-A63-FMH22-47-60	801.189	1	22	47	60	18	5	10	M10	36
HSK-A63-FMH22-47-90	978.186	1	22	47	90	18	5	10	M10	36
HSK-A63-FMH22-47-150	801.188	1	22	47	150	18	5	10	M10	36
HSK-A63-FMH22-60-60	805.573	2	22	60	60	18	5	10	M10	38
HSK-A63-FMH22-60-90	805.574	2	22	60	90	18	5	10	M10	38
HSK-A63-FMH27-60-60	978.185	2	27	60	60	20	6	12	M12	46
HSK-A63-FMH27-60-90	979.196	2	27	60	90	20	6	12	M12	46
HSK-A63-FMH32-96-60	805.646	2	32	96	60	22	7	14	M16	58
HSK-A100-FMH22-47-105	965.523	1	22	47	105	18	5	10	M10	36
HSK-A100-FMH22-47-150	978.120	1	22	47	150	18	5	10	M10	36
HSK-A100-FMH22-47-200	978.121	1	22	47	200	18	5	10	M10	36
HSK-A100-FMH22-47-250	801.091	1	22	47	250	18	5	10	M10	36
HSK-A100-FMH22-60-60	801.096	1	22	60	60	18	5	10	M10	38
HSK-A100-FMH22-60-105	801.092	1	22	60	105	18	5	10	M10	38
HSK-A100-FMH22-60-150	801.093	1	22	60	150	18	5	10	M10	38
HSK-A100-FMH22-60-200	801.094	1	22	60	200	18	5	10	M10	38
HSK-A100-FMH22-60-250	801.095	1	22	60	250	18	5	10	M10	38
HSK-A100-FMH27-60-60	801.102	1	27	60	60	20	6	12	M12	46
HSK-A100-FMH27-60-90	801.103	1	27	60	90	20	6	12	M12	46
HSK-A100-FMH27-60-150	801.101	1	27	60	150	20	6	12	M12	46
HSK-A100-FMH27-60-200	807.130	1	27	60	200	20	6	12	M12	46
HSK-A100-FMH27-60-250	807.114	1	27	60	250	20	6	12	M12	46
HSK-A100-FMH27-76-60	801.105	1	27	76	60	20	6	12	M12	62
HSK-A100-FMH27-76-90	801.106	1	27	76	90	20	6	12	M12	62
HSK-A100-FMH27-76-150	801.104	1	27	76	150	20	6	12	M12	62
HSK-A100-FMH32-96-60	801.118	2	32	96	60	22	7	14	M16	80
HSK-A100-FMH32-96-90	801.119	2	32	96	90	22	7	14	M16	80
HSK-A100-FMH32-96-150	801.117	2	32	96	150	22	7	14	M16	80
HSK-A100-FMH40-100-75	801.125	2	40	100	75	26	8.5	16	M20 (MBA-M20H)	80
HSK-A100-FMH40-100-105	801.124	2	40	100	105	26	8.5	16	M20 (MBA-M20H)	80

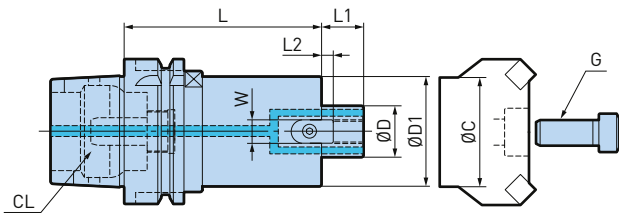

Fig. 1

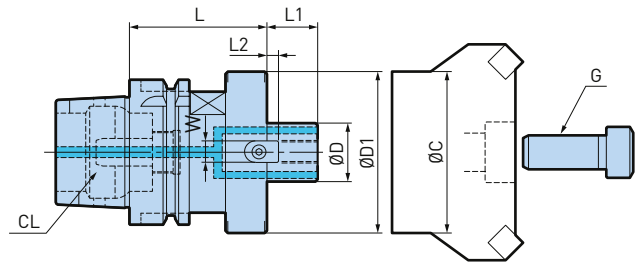

Fig. 2

A.3

Model	Order No.	Fig.	ØD	ØD1	L	L1	L2	W	G	ØC min.
HSK-A125-FMH22A-49-50	806.585	1	22	49	50	18	5	10	M10	40
HSK-A125-FMH22A-49-100	806.586	1	22	49	100	18	5	10	M10	40
HSK-A125-FMH22A-49-150	806.587	1	22	49	150	18	5	10	M10	40
HSK-A125-FMH22A-49-200	806.588	1	22	49	200	18	5	10	M10	36
HSK-A125-FMH27A-60-90	806.589	1	27	60	90	20	6	12	M12	46
HSK-A125-FMH27A-60-150	806.590	1	27	60	150	20	6	12	M12	46
HSK-A125-FMH32A-78-60	806.591	1	32	76	60	22	7	14	M16	58
HSK-A125-FMH32A-96-105	806.592	1	32	98	105	22	7	14	M16	58
HSK-A125-FMH40A-80-90	806.593	1	40	80	90	28	8.5	16	M20	70

1. Clamp bolt is included.
2. By using a clamping screw with a through bore, coolant is supplied through the screw
3. Coolant pipe [CL] is to be ordered separately.

Accessories & Spare Parts

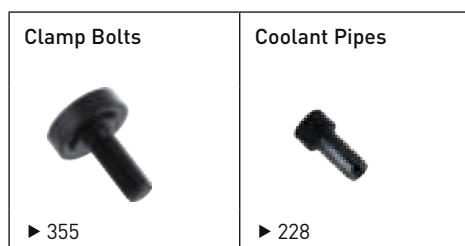

Smart Damper Basic Holders for Mills

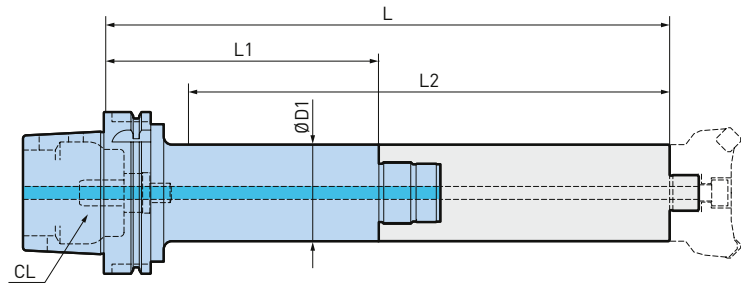

A.3

Model	Order No.	ØD1	L	L1	L2	Damper Head Model
HSK-A100-SDF36-47-170	804.976	47	350	170	310	FMH_DP-47
HSK-A100-SDF36-47-220	804.978	47	400	220	360	FMH_DP-47
HSK-A100-SDF36-60-170	804.977	60	350	170	310	FMH_DP-60
HSK-A100-SDF36-60-220	804.979	60	400	220	360	FMH_DP-60
HSK-A100-SDF57-76-170	807.680	76	350	170	310	FMH_DP-76
HSK-A100-SDF57-76-220	807.681	76	400	220	360	FMH_DP-76
HSK-A125-SDF36-47-250	806.630	47	430	250	380	FMH_DP-47
HSK-A125-SDF36-60-250	806.631	60	430	250	380	FMH_DP-60

1. Coolant pipe [CL] is to be ordered separately.

Combinations

Basic Holder

Damper Head

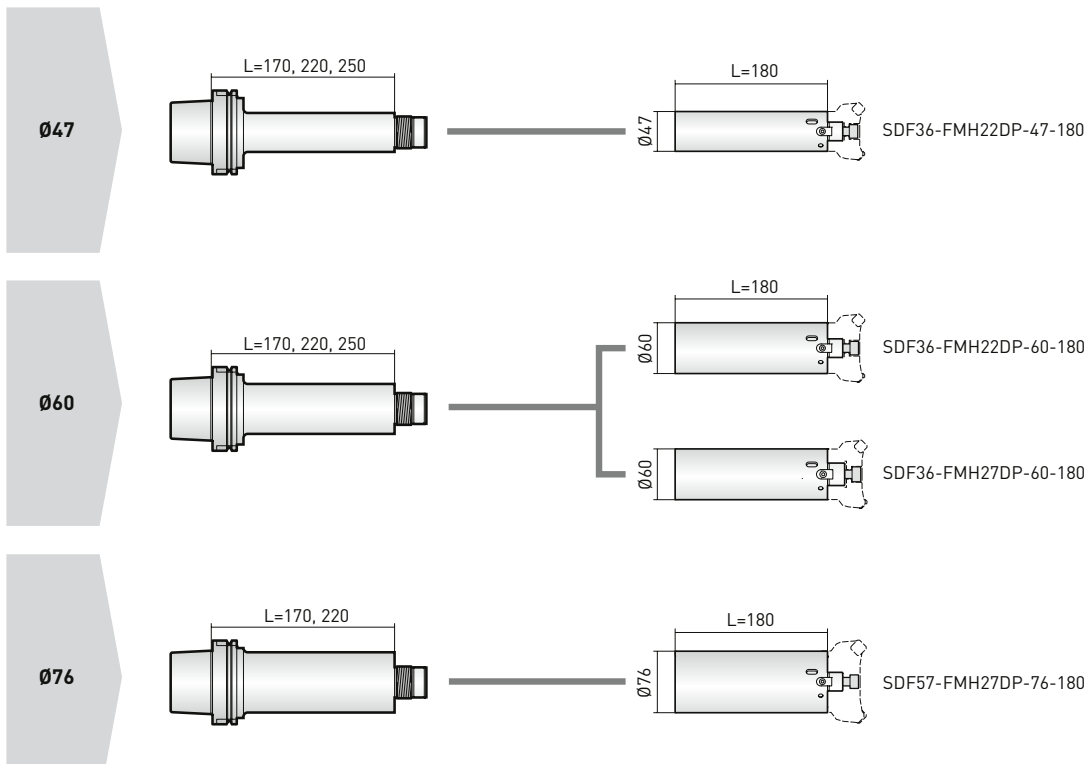

Accessories & Spare Parts

Coolant Pipes



► 228

Smart Damper Damper Heads for Mills

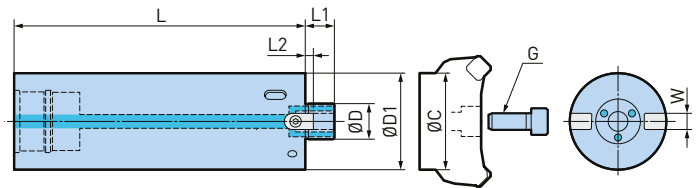
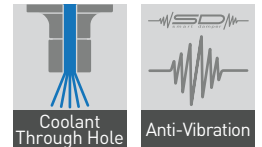

A.3

Model	Order No.	ØD	ØD1	L	L1	L2	G	W	ØC min.	Wrench
SDF36-FMH22DP-47-180	804.969	22	47	180	18	5	M10	10	36	FK45-50L
SDF36-FMH22DP-60-180	804.971	22	60	180	18	5	M10	10	38	FK58-62L
SDF36-FMH27DP-60-180	804.972	27	60	180	20	6	M12	12	46	FK58-62L
SDF57-FMH27DP-76-180	807.673	27	76	180	20	6	M12	12	48	FK68-75L

1. Wrench and cutter clamping bolt are included.
2. By using a clamping screw with a through bore, coolant is supplied through the screw

Accessories & Spare Parts

<p>FK Wrenches</p>  <p>▶ 352</p>	<p>Clamp Bolts</p>  <p>▶ 355</p>
---	---

Super Keyless Chuck

The known design assures prismatic clamping between 0.5 and 13 mm.

A.3

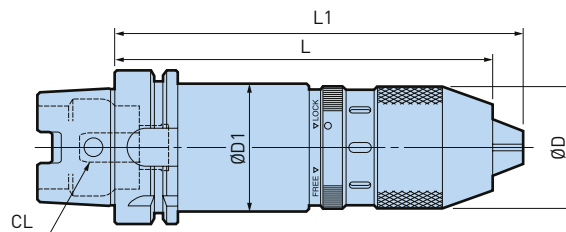

ø3 - 42mm

Model	Order No.	Ød	ØD	ØD1	L	L1	Wrench
HSK-A63-SKL13-155	805.282	0.5 - 13	51	53	155	167.5	FS13LC

- Coolant-through hole is not available.
- Wrench is included.

Side Lock Drill Holder

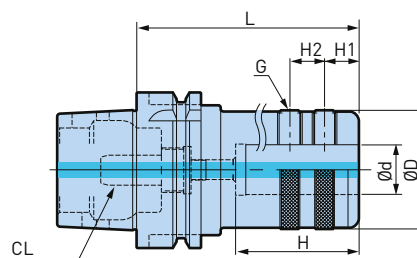
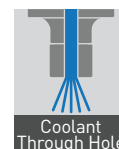

ø16 - 50mm

Model	Order No.	Ød	ØD	L	H	H1	H2	G
HSK-A63-TSL16-90	805.234	16	48	90	48	14	14	M10
HSK-A63-TSL20-90	805.235	20	48	90	50	14	14	M10
HSK-A63-TSL25-90	805.236	25	48	90	56	15	20	M16
HSK-A63-TSL32-105	805.237	32	63	105	60	15	20	M16
HSK-A63-TSL40-120	805.232	40	68	120	70	15	25	M16
HSK-A100-TSL16-90	806.044	16	48	90	48	14	14	M10
HSK-A100-TSL20-90	806.045	20	48	90	50	14	14	M10
HSK-A100-TSL25-90	806.046	25	48	90	56	15	20	M16
HSK-A100-TSL32-105	806.047	32	63	105	60	15	20	M16
HSK-A100-TSL40-105	806.048	40	68	105	70	15	25	M16
HSK-A100-TSL50-105	806.049	50	84	105	70	15	25	M16

- Coolant pipe (CL) is to be ordered separately.

Accessories & Spare Parts

Sleeves for TSL & OSL



► 355

Side Lock Holders for Weldon

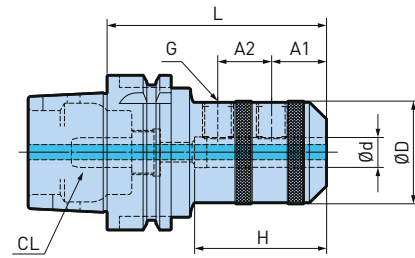

A.3

ø6 - 50mm

Model	Order No.	Ød	ØD	L	A1	A2	H	G
HSK-A63-ISL6-80	807.321	6	25	80	18	-	58	M6
HSK-A63-ISL8-80	807.322	8	28	80	18	-	58	M8
HSK-A63-ISL10-80	807.323	10	35	80	20	-	44	M10
HSK-A63-ISL12-80	805.732	12	42	80	22.5	-	50	M12
HSK-A63-ISL16-80	807.319	16	48	80	24	-	52	M14
HSK-A63-ISL20-80	806.050	20	52	80	25	-	54	M16
HSK-A63-ISL25-105	805.019	25	65	105	24	25	60	M18 P2
HSK-A63-ISL32-115	805.018	32	72	115	24	28	64	M20 P2
HSK-A100-ISL20-90	805.152	20	52	90	25	-	54	M16
HSK-A100-ISL20-135	807.227	20	52	135	25	-	55	M16
HSK-A100-ISL25-105	806.051	25	65	105	24	25	60	M18 P2
HSK-A100-ISL25-135	807.228	25	65	135	24	25	60	M18 P2
HSK-A100-ISL32-125	805.151	32	72	125	24	28	90	M20 P2
HSK-A100-ISL32-165	807.229	32	72	165	24	28	90	M20 P2
HSK-A100-ISL40-125	805.201	40	90	125	30	32	90	M20 P2
HSK-A100-ISL40-165	807.230	40	90	165	30	32	90	M20 P2
HSK-A100-ISL50-135	806.052	50	99.5	135	35	35	90	M24 P2
HSK-A100-ISL50-165	807.231	50	99.5	165	35	35	90	M24 P2

1. "H" is the max. tool shank length that can be inserted for these models.
2. Use a cutting tool in accordance to DIN 1835 B/DIN 6535 HB.
3. Coolant pipe (CL) is to be ordered separately.

Accessories & Spare Parts

Coolant Pipes



► 228

HOLDERS for Screw-On Cutter

General metric screw-on type cutting tools can be used with these models.

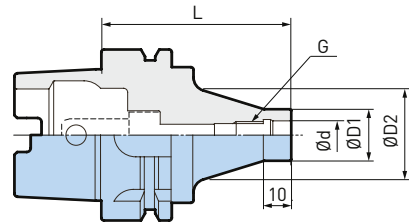
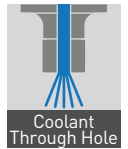

A.3

Model	Order No.	Ød	ØD1	ØD2	L	G
HSK-A63-M8-15-75	101142.001.0	8.5	15	30	75	M8
HSK-A63-M10-19-70	101142.002.0	10.5	19	35	70	M10
HSK-A63-M12-24-65	101142.003.0	12.5	24	40	65	M12
HSK-A63-M16-29-60	101142.004.0	17	29	40	60	M16

Morse Taper Holder

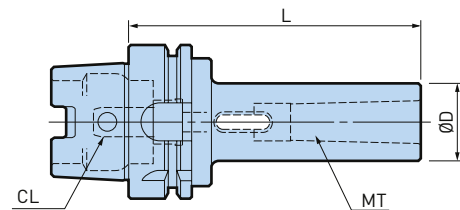

Model	Order No.	ØD	MT No.	L
HSK-A63-MTA1-100	801.248	25	1	100
HSK-A63-MTA2-120	801.249	32	2	120
HSK-A63-MTA3-135	801.250	40	3	135
HSK-A63-MTA4-165	801.251	50	4	165
HSK-A100-MTA1-105	801.165	25	1	105
HSK-A100-MTA2-125	801.166	32	2	125
HSK-A100-MTA3-140	801.167	40	3	140
HSK-A100-MTA4-165	801.168	50	4	165

1. Coolant pipe (CL) is to be ordered separately.

MEGA Synchro Tapping Holder

Compensates for synchronization errors during synchronised tapping. Improves thread quality and tool life by reducing thrust loads caused by synchronization errors up to 90%.

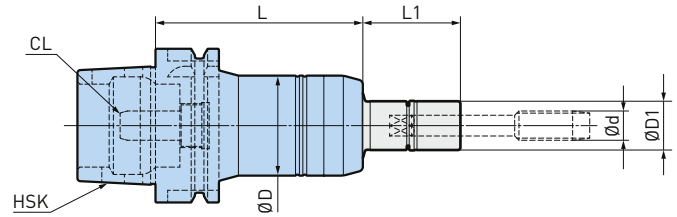

M3 - M20

Model	Order No.	Tap Holder	Ød	ØD	ØD1	L	L1
HSK-A40-MGT6-80	965.601	MGT6	M3-M8	36	16	80	30 - 200
HSK-A40-MGT12-85	965.602	MGT12	M5-M12 / P1/8	41	20	85	30 - 200
HSK-A50-MGT6-85	965.603	MGT6	M3-M8	36	16	85	30 - 200
HSK-A50-MGT12-85	965.604	MGT12	M5-M12 / P1/8	41	20	85	30 - 200
HSK-A50-MGT20-125	978.325	MGT20	M10-M20 / P1/4-P1/2	54	30	125	35 - 150
HSK-A63-MGT6-85	965.606	MGT6	M3-M8	36	16	85	30 - 200
HSK-A63-MGT12-85	965.607	MGT12	M5-M12 / P1/8	41	20	85	30 - 200
HSK-A63-MGT20-110	965.608	MGT20	M10-M20 / P1/4-P1/2	54	30	110	35 - 150
HSK-A100-MGT6-95	965.609	MGT6	M3-M8	36	16	95	30 - 200
HSK-A100-MGT12-95	965.610	MGT12	M5-M12 / P1/8	41	20	95	30 - 200
HSK-A100-MGT20-115	965.611	MGT20	M10-M20 / P1/4-P1/2	54	30	115	35 - 150
HSK-A125-MGT12-105	805.655	MGT12	M5-M12 / P1/8	41	20	105	30 - 200
HSK-A125-MGT20-120	805.656	MGT20	M10-M20 / P1/4-P1/2	54	30	120	35 - 150

1. Tap holder is to be ordered separately.
2. Coolant pipe (CL) is to be ordered separately.
3. Synchrized tapping function is required on the machine.

MEGA Synchro Tapping Holder MGT36

For large Tapping: Type MGT36

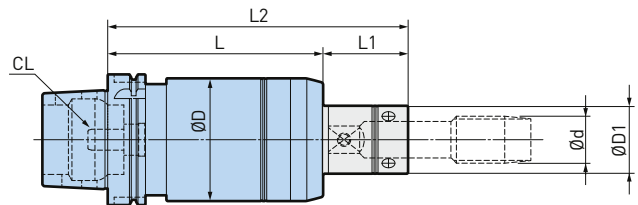

M20 - M36

Model	Order No.	Ød	ØD1	L	L1	L2
HSK-A100-MGT36-165	801.164	M22-M36 / P5/8-P1	32-52	165	65	230
HSK-A125-MGT36-170	805.657	M22-M36 / P1/2-P1	32-52	170	65	235

1. Tap holder is to be ordered separately.
2. Coolant pipe (CL) is to be ordered separately.
3. Synchrized tapping function is required on the machine.

Accessories & Spare Parts

Tap Holder	MEGA Wrenches	Accessories	Coolant Pipes
 ▶ 356-363	 ▶ 351	 ▶ 364-365	 ▶ 228

MEGA Synchro Tapping Holder

For small Tapping: Type MGT3

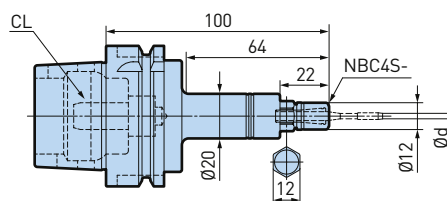

A.3

M1 - M3

Model	Order No.	Ød
HSK-A63-MGT3-100	805.542	M1 - M3

1. MEGA nut is included in delivery.
2. MEGA wrench (MGR12) and common spanner (12 mm) are required to clamp/unclamp the tap.
3. Synchronized tapping function is required on the machine.
4. Coolant pipe (CL) is to be ordered separately.
5. Coolant-through hole is not available.
6. La micro-pince doit être commandée séparément.

Micro Collet for MGT3

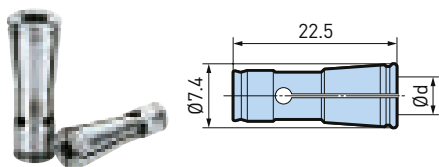

Model	Order No.	Tapping Range			Tap Shank Ød
		DIN 371	ISO 529	JIS	
NBC4S-2.5AA	961.468	M1 - M1.8	M2	-	2.5
-2.8AA	968.353	M2 - M2.6	M2.2, M2.5	-	2.8
-3.0AA	961.470	-	-	M1 - M2.6	3.0
-3.1AA	968.355	-	M3	-	3.15
-3.5AA	961.472	M3	-	-	3.5
-4.0AA	961.474	-	-	M3	4.0

1. Other sizes available. Please refer to micro collet.

Accessories & Spare Parts

MEGA Wrenches



▶ 351

New Baby Chuck Type

The Angle Head has an integrated New Baby Chuck, resulting in high precision. Available in various sizes to meet specific production requirements.

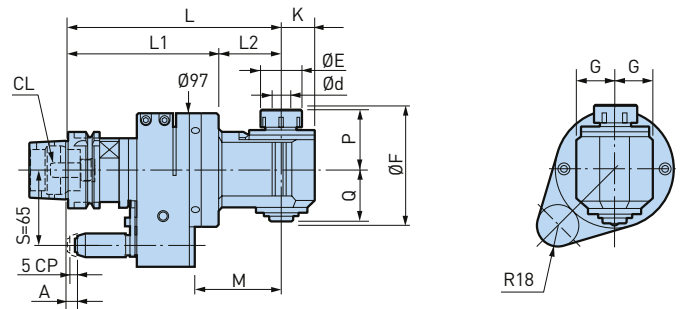

HSK-A63

A.3

Model	Order No.	Ød	ØE	ØF	L	L1	L2	G	K	M	P	Q	Collet Model
HSK-A63-AG90/NBS6-185	802.717	0.25 - 6	20	67	185	130	55	21	17	77	33	29	NBC6
HSK-A63-AG90/NBS6-215	802.719	0.25 - 6	20	67	215	130	85	21	17	107	33	29	NBC6
HSK-A63-AG90/NBS6-245	802.721	0.25 - 6	20	67	245	130	115	21	17	137	33	29	NBC6
HSK-A63-AG90/NBS6-275	802.723	0.25 - 6	20	67	275	130	145	21	17	167	33	29	NBC6
HSK-A63-AG90/NBS10-185	802.702	1.5 - 10	30	91	185	130	55	30	25	77	45	43	NBC10
HSK-A63-AG90/NBS10-215	802.704	1.5 - 10	30	91	215	130	85	30	25	107	45	43	NBC10
HSK-A63-AG90/NBS10-245	802.706	1.5 - 10	30	91	245	130	115	30	25	137	45	43	NBC10
HSK-A63-AG90/NBS13-185	802.708	2.5 - 13	35	101	185	130	55	31	28	77	52	45	NBC13
HSK-A63-AG90/NBS13-215	802.710	2.5 - 13	35	101	215	130	85	31	28	107	52	45	NBC13
HSK-A63-AG90/NBS13-245	802.712	2.5 - 13	35	101	245	130	115	31	28	137	52	45	NBC13
HSK-A63-AG90/NBS20S-180S	802.716	2.5 - 20	46	132	180	127	53	35	33	72	65	62	NBC20

continues on the next page



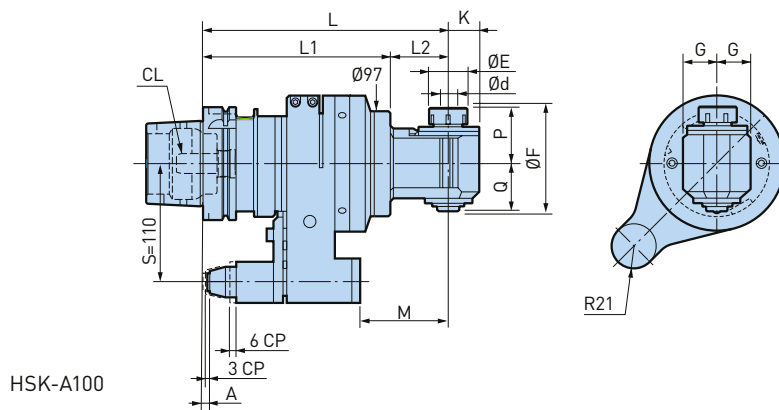

Model	Order No.	Ød	ØE	ØF	L	L1	L2	G	K	M	P	Q	Collet Model
HSK-A100-AG90/NBS6-225	802.666	0.25 - 6	20	67	225	170	55	21	17	82	33	29	NBC6
HSK-A100-AG90/NBS6-255	802.669	0.25 - 6	20	67	255	170	85	21	17	112	33	29	NBC6
HSK-A100-AG90/NBS6-285	802.672	0.25 - 6	20	67	285	170	115	21	17	142	33	29	NBC6
HSK-A100-AG90/NBS6-315	802.675	0.25 - 6	20	67	315	170	145	21	17	172	33	29	NBC6
HSK-A100-AG90/NBS10-225	802.645	1.5 - 10	30	91	225	170	55	30	25	82	45	43	NBC10
HSK-A100-AG90/NBS10-255	802.648	1.5 - 10	30	91	255	170	85	30	25	112	45	43	NBC10
HSK-A100-AG90/NBS10-285	802.651	1.5 - 10	30	91	285	170	115	30	25	142	45	43	NBC10
HSK-A100-AG90/NBS13-225	802.654	2.5 - 13	35	101	225	170	55	31	28	82	52	45	NBC13
HSK-A100-AG90/NBS13-255	802.657	2.5 - 13	35	101	255	170	85	31	28	112	52	45	NBC13
HSK-A100-AG90/NBS13-285	802.660	2.5 - 13	35	101	285	170	115	31	28	142	52	45	NBC13
HSK-A100-AG90/NBS20-240	802.663	2.5 - 20	46	132	240	170	70	35	35	97	65	62	NBC20
HSK-A100-AG90/NBS20-240S	802.664	2,5 - 20	46	132	240	170	70	35	35	97	65	62	NBC20

1. The standard fixed length A is 8 mm for HSK-A63 and 6 mm for HSK-A100. Other lengths are available upon request.
2. Nut and wrench are included.
3. New Baby Collet is to be ordered separately
4. No puede utilizarse la pinza New Baby para fresado (NBC - EAA).
5. Coolant can be supplied through the locating pin.
6. Coolant pipe (CL) is to be ordered separately.
7. Exclusive Stop Block is required.
8. „CP“ indicates compression.
9. „ØF“ indicates the minimum dimension for access into the bore

Accessories & Spare Parts

<p>New Baby Collets</p>  <p>▶ 327</p>	<p>Semi-Finished Stop Blocks</p>  <p>▶ 377</p>	<p>Coolant Pipes</p>  <p>▶ 228</p>
--	---	---

Angle Head Twin Head Type

Twin spindle head with a compact design. Symmetrical machining can be performed using one unit, contributing to the reduction of the number of magazine tool spots.

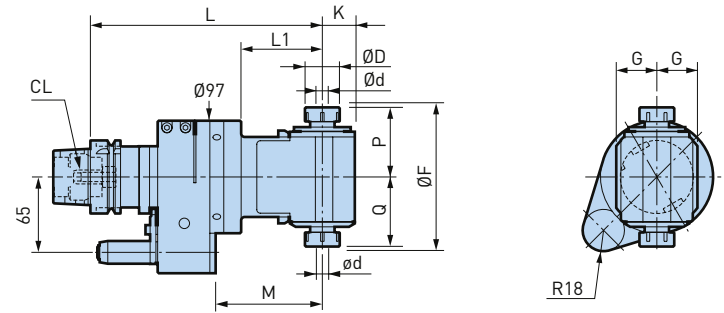

Fig. 1

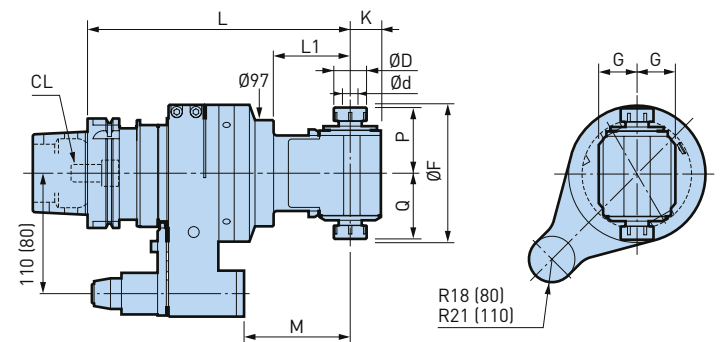

Fig. 2

Model	Order No.	Fig.	Ød	ØD	G	K	L	L1	M	P	Q	ØF	Collet Model
HSK-A63-AG90/NBS10W-200	101123.001.0	1	1.5 - 10	30	31	28	200	70	97	60	60	124	NBC10
HSK-A100-AG90/NBS10W-240	101123.002.0	2	1.5 - 10	30	31	28	240	70	92	60	60	124	NBC10

- Coolant pipe (CL) is to be ordered separately.
- Exclusive Stop Block is required.
- Nut is included.
- Wrench is included.
- No puede utilizarse la pinza New Baby para fresado (NBC - EAA).
- The cutting tool rotates in reverse to the machine spindle.
- Collet is not included.
- The angles of the locating pin to the drive key groove and direction of cutting edge are freely adjustable.
- When used with stop block peripheral cooling is possible
- Automatic tool change may not be available, depending on machine models.
- Output spindles do not rotate in the same direction simultaneously.
- The standard fixed length A is 8 mm for HSK-A63 and 6 mm for HSK-A100. Other lengths are available upon request.
- Order No. for HSK-A100 is with S = 110. S = 80 type for HSK-A100 is available upon request.

Accessories & Spare Parts

New Baby Collets



► 327

OAG Type

A.3

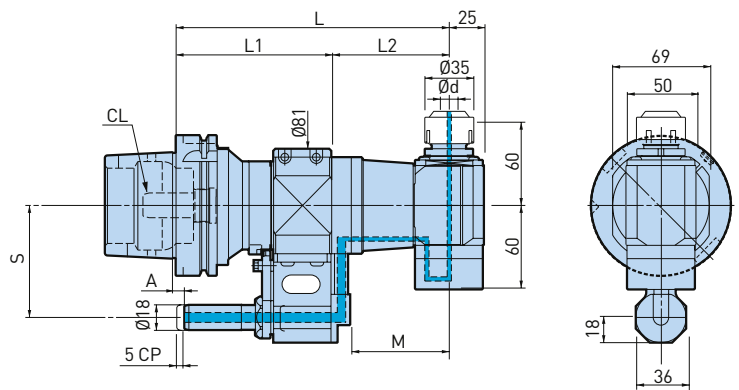

Model	Order No.	Ød	L	L1	L2	M	Collet Model	Nut Model	max. min-1
HSK-A63-OAG90-13-185	802.736	2.5 - 13	185	101	84	70.5	NBC13	BPS13	5000
HSK-A100-OAG90-13-195	802.697	2.5 - 13	195	111	84	70.5	NBC13	BPS13	5000

1. The standard length A is 6 mm.
2. Standard "S" is 80 mm for HSK-A100 and 65 mm for HSK-A63.
3. Nut and wrench are included.
4. New Baby Collet is to be ordered separately
5. No puede utilizarse la pinza New Baby para fresado (NBC - EAA).
6. Coolant pipe (CL) is to be ordered separately.
7. Exclusive Stop Block is required.
8. „CP” indicates compression.

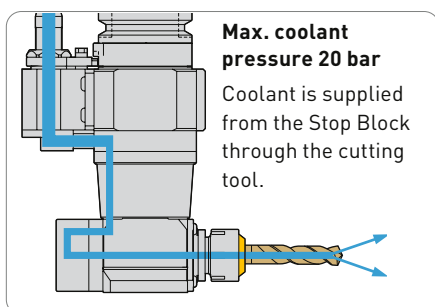

Accessories & Spare Parts

<p>Baby Perfect Seals</p>  <p>▶ 338</p>	<p>New Baby Collets</p>  <p>▶ 327</p>	<p>Semi-Finished Stop Blocks</p>  <p>▶ 377</p>
--	--	---

Small Bore Type

Angular operation from a $\varnothing 30$ mm bore is possible. Modular heads enhance versatility. Head is aligned with spindle center for easy programming.

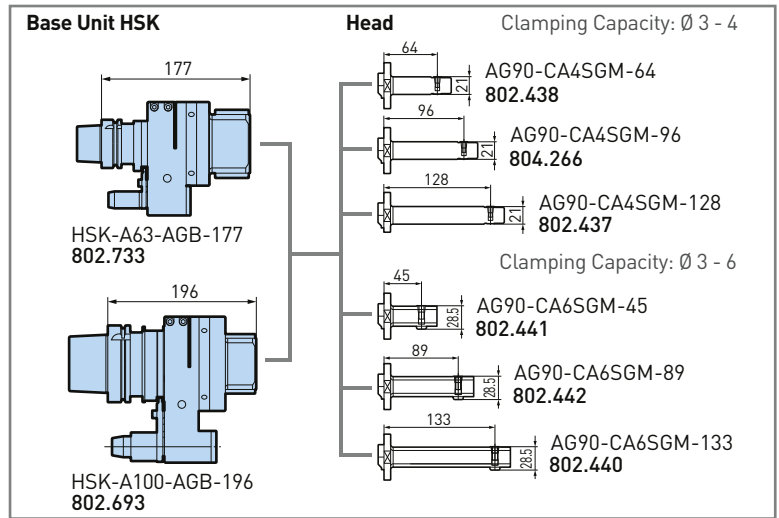

A.3

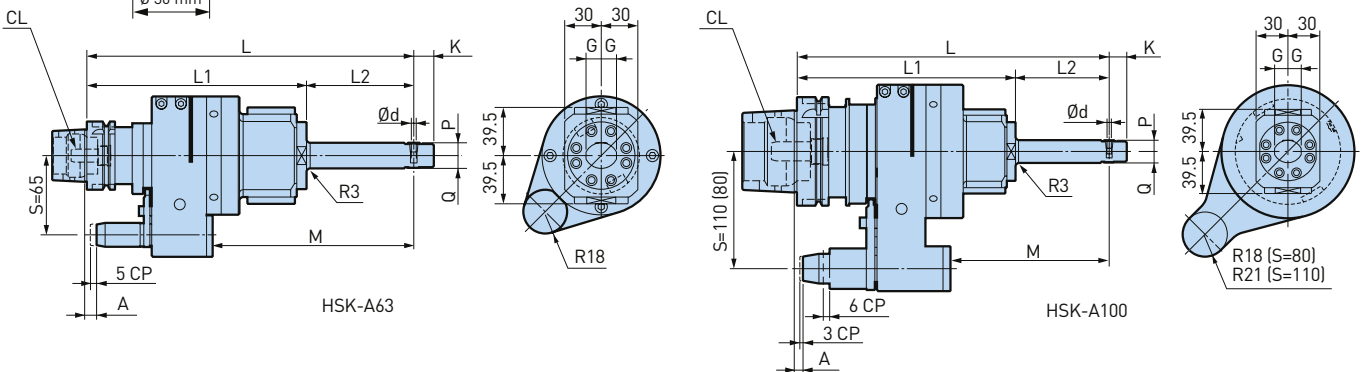

Model	Order No.	Base Unit	Head	$\varnothing d$	L	L1	L2	G	K	M	P	Q	Ratio
HSK-A63-AG90-CA4SGM-241	802.727	HSK-A63-AGB-177	AG90-CA4SGM-64	3 - 4	241	185	56	12.5	16.5	133	10.5	10.5	1:1.06
HSK-A63-AG90-CA4SGM-273	802.728	HSK-A63-AGB-177	AG90-CA4SGM-96	3 - 4	273	185	88	12.5	16.5	165	10.5	10.5	1:1.06
HSK-A63-AG90-CA4SGM-305	802.729	HSK-A63-AGB-177	AG90-CA4SGM-128	3 - 4	305	185	120	12.5	16.5	197	10.5	10.5	1:1.06
HSK-A63-AG90-CA6SGM-222	802.730	HSK-A63-AGB-177	AG90-CA6SGM-45	3 - 6	222	185	37	15	20	114	12.5	16	1:0.77
HSK-A63-AG90-CA6SGM-266	802.731	HSK-A63-AGB-177	AG90-CA6SGM-89	3 - 6	266	185	81	15	20	158	12.5	16	1:0.77
HSK-A63-AG90-CA6SGM-310	802.732	HSK-A63-AGB-177	AG90-CA6SGM-133	3 - 6	310	185	125	15	20	202	12.5	16	1:0.77
HSK-A100-AG90-CA4SGM-260	802.680	HSK-A100-AGB-196	AG90-CA4SGM-64	3 - 4	260	204	56	12.5	16.5	117	10.5	10.5	1:1.06
HSK-A100-AG90-CA4SGM-292	802.682	HSK-A100-AGB-196	AG90-CA4SGM-96	3 - 4	292	204	88	12.5	16.5	149	10.5	10.5	1:1.06
HSK-A100-AG90-CA4SGM-324	802.684	HSK-A100-AGB-196	AG90-CA4SGM-128	3 - 4	324	204	120	12.5	16.5	181	10.5	10.5	1:1.06
HSK-A100-AG90-CA6SGM-241	802.686	HSK-A100-AGB-196	AG90-CA6SGM-45	3 - 6	241	204	37	15	20	98	12.5	16	1:0.77
HSK-A100-AG90-CA6SGM-285	802.688	HSK-A100-AGB-196	AG90-CA6SGM-89	3 - 6	285	204	81	15	20	145	12.5	16	1:0.77
HSK-A100-AG90-CA6SGM-329	802.690	HSK-A100-AGB-196	AG90-CA6SGM-133	3 - 6	329	204	125	15	20	186	12.5	16	1:0.77

- Standard fixed length A is 6 mm for HSK-A100 and 8 mm for HSK-A63. Other lengths are available upon request.
- Order No. for HSK-A100 is with S = 110. S = 80 type for HSK-A100 is available upon request.
- Coolant-through hole is not available.
- Exclusive collet is to be ordered separately.
- Coolant pipe (CL) is to be ordered separately.
- Exclusive Stop Block is required.
- „CP“ indicates compression.
- max. 2000 min-1

Accessories & Spare Parts

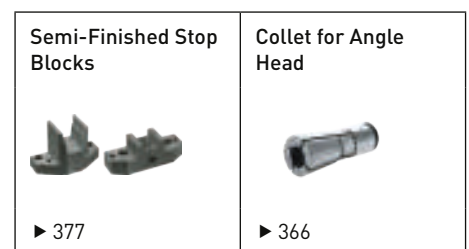

Build-Up Type

Designed for greater rigidity by having the face of the spindle bore in line with the center of the machine spindle. Also helps minimize interference problems with the ATC and storage problems within the magazine.



A.3

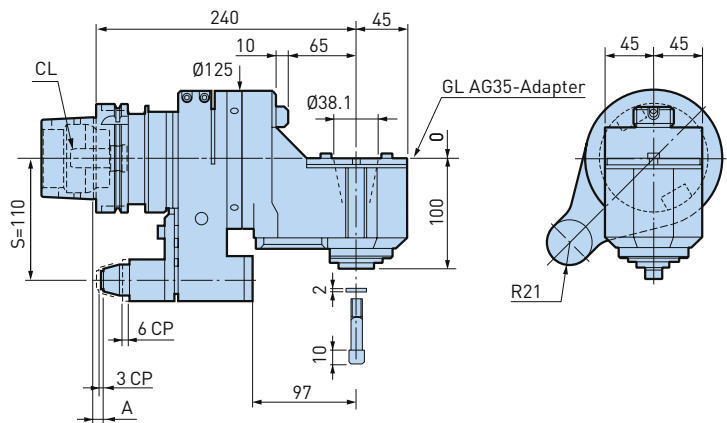

Model	Order No.	max. min-1	Connection tool side
HSK-A100-AG90/AGH35-240	802.639	3000	AGH35
HSK-A100-AG90/AGH35-240S	802.640	3000	AGH35

1. Models with "S" at the end are high rigidity type.
2. The standard length A is 6 mm.
3. Order No. is with S = 110. S = 80 type is available upon request.
4. Coolant can be supplied through the locating pin.
5. Coolant pipe (CL) is to be ordered separately.
6. Exclusive Stop Block is required.
7. „CP" indicates compression.

Accessories & Spare Parts

Semi-Finished Stop Blocks



► 377

AG35 adapters

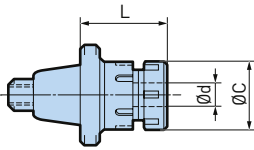
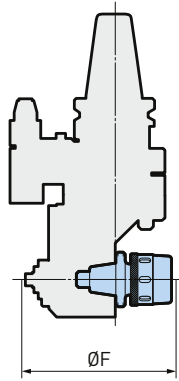
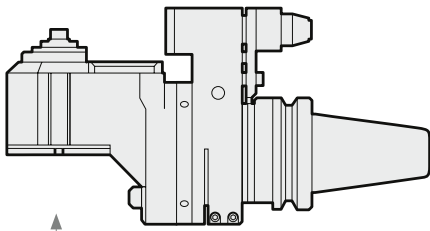

AG35 adapters New Baby Chuck

Model	Order No.	Ød	L	ØC	ØF	Collet Model
AG35-NBS10	962.793	1.5 - 10	47	30	162	NBC10
AG35-NBS13	962.794	2.5 - 13	54	35	168	NBC13
AG35-NBS16	962.795	2.5 - 16	54	42	170	NBC16
AG35-NBS20	962.796	2.5 - 20	54	46	170	NBC20

1. New baby collet and wrench are to be ordered separately.

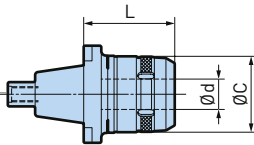

AG35 adapters New Hi-Power Milling Chuck

Model	Order No.	Ød	L	ØC	ØF	Head
AG35-HMC20S	802.742	20	60	50	178	AG35

1. Wrench (FK45-50L) is included.

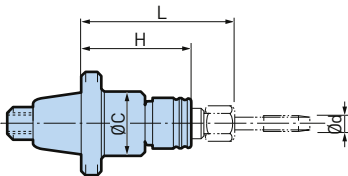

AG35 adapters Auto Tapper Type B (automatic depth control)

Model	Order No.	Ød	ØC	L	H	Head
AG35-ATB12E	802.435	M4 - M12	40.5	80	72	AG35
AG35-ATB20E	802.436	M8 - M20	57.5	115	102.5	AG35

1. Please contact BIG KAISER agent for tap collet.

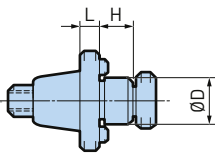

AG35 adapters Face Mill Arbor

Model	Order No.	ØD	L	H	Head
AG35-FMH22-30	802.740	22	30	18	AG35
AG35-FMH27-20	802.741	27	20	20	AG35

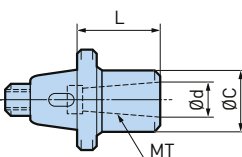

AG35 adapters Morse Taper Adapter

Model	Order No.	Ød	MT No.	L	ØC	ØF	Head
AG35-MT1	962.785	12.065	1	50	24	164	AG35
AG35-MT2	962.786	17.78	2	60	32	180	AG35

HMC Type

Improved versatility is achieved from the 32 mm capacity Milling Chuck by using parallel reduction collets and other accessories.



A.3

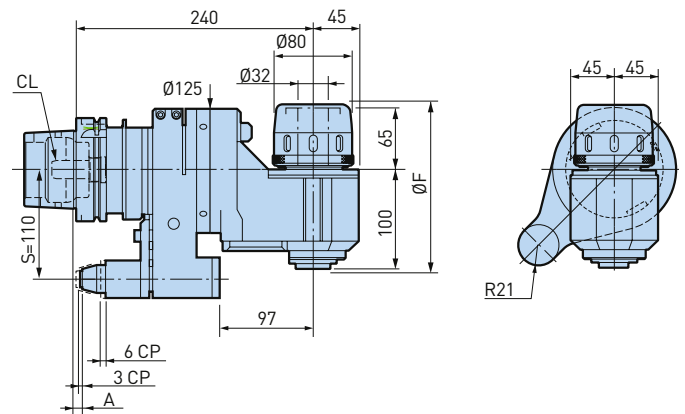

Model	Order No.	max. min-1
HSK-A100-AG90/HMC32-240	802.642	3000
HSK-A100-AG90/HMC32-240S	802.643	3000

1. Exclusive Stop Block is required.
2. The standard length A is 6 mm.
3. Order No. is with S = 110. S = 80 type is available upon request.
4. Wrench (FK80-90) is included.
5. Coolant can be supplied through the locating pin.
6. Coolant pipe (CL) is to be ordered separately.
7. „CP“ indicates compression.
8. „ØF“ indicates the minimum dimension for access into the bore

Accessories & Spare Parts

<p>C Collets</p>  <p>▶ 349</p>	<p>Semi-Finished Stop Blocks</p>  <p>▶ 377</p>
---	---

Universal Type

Suitable for cutting angles between 0° and 90°. In addition to that the cutter head can be rotated a full 360°, increasing flexibility!

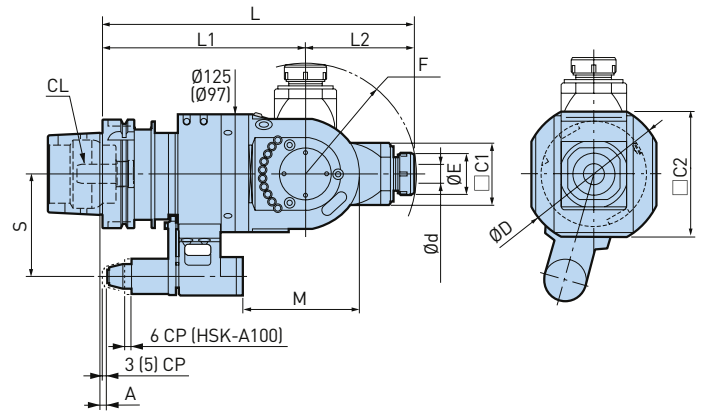

A.3

Model	Order No.	Ød	ØD	ØE	L	L1	L2	C1	C2	M	F	S	max. min-1	Collet Model
HSK-A63-AGU/NBS13-285	802.734	2.5 - 13	115	35	285	185	100	51	97	124	102	65	6000	NBC13
HSK-A100-AGU/NBS20-325	802.695	2.5 - 20	140	46	325	210	115	65	125	125	118	110	4000	NBC20

1. Exclusive Stop Block is required.
2. Order No. for HSK-A100 is with S = 110. S = 80 type for HSK-A100 is available upon request.
3. Standard fixed length A is 6 mm for HSK-A100 and 8 mm for HSK-A63. Other lengths are available upon request.
4. Figures in () in the drawing indicate dimensions for HSK-A63.
5. Nut and wrench are included.
6. Coolant can be supplied through the locating pin.
7. Coolant pipe [CL] is to be ordered separately.
8. „CP” indicates compression.



Easily adjustable spindle angle from 0° to 90°.



Unique setting mechanism enables the spindle angle to be precisely set at 1° increments.



Specially selected materials and special design for clamping the head guarantees rigidity for even end milling applications.

Accessories & Spare Parts

<p>New Baby Collets</p> <p>► 327</p>	<p>Semi-Finished Stop Blocks</p> <p>► 377</p>
---	--

AGU30 Type

Spindle angle is adjustable from 0° to 30°. Large swivel flange assures high rigidity.

A.3

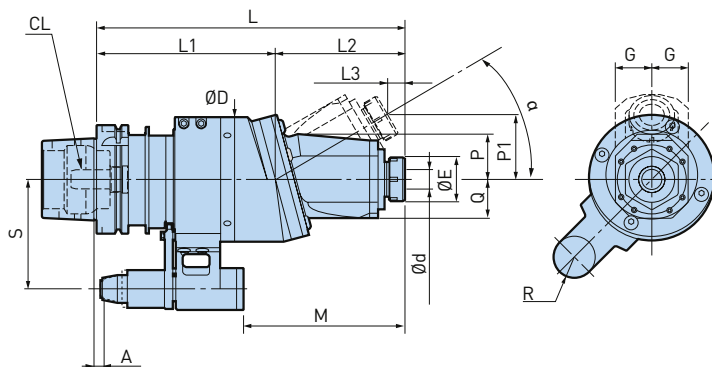

Model	Order No.	Ød	ØD	ØE	L	L1	L2	L3	G	Q	P	P1 max.	R	S	max. min-1	Collet Model
HSK-A63-AGU30/NBS13-255	802.735	2.5 - 13	97	35	255	150	105	14	29	30	34	52.5	18	65	6000	NBC13
HSK-A100-AGU30/NBS20-305	802.696	2.5 - 20	125	46	305	175	130	17	36.5	39	45	65	21	110	4000	NBC20

1. Exclusive Stop Block is required.
2. Order No. for HSK-A100 is with S = 110. S = 80 type for HSK-A100 is available upon request.
3. Standard fixed length A is 6 mm for HSK-A100 and 8 mm for HSK-A63. Other lengths are available upon request.
4. New baby nut, wrench and setting disc are included.
5. Coolant can be supplied through the locating pin.
6. Coolant pipe (CL) is to be ordered separately.

Setting Disc (included accessory)

For precise adjustment of the spindle angle or direction.

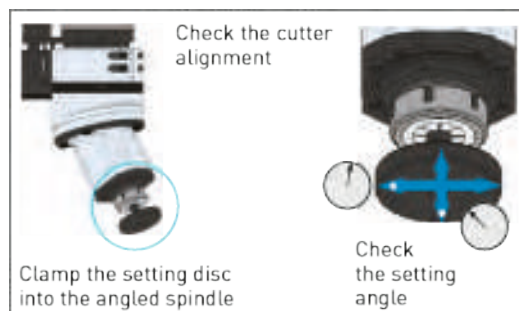
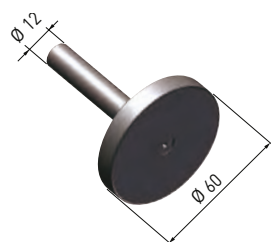

Spindle angle is easily adjustable from 0° to 30° using the scale indication on the body.

Accessories & Spare Parts

<p>New Baby Collets</p> <p>▶ 327</p>	<p>Semi-Finished Stop Blocks</p> <p>▶ 377</p>
---	--

Air Turbine Spindle Center Through Type

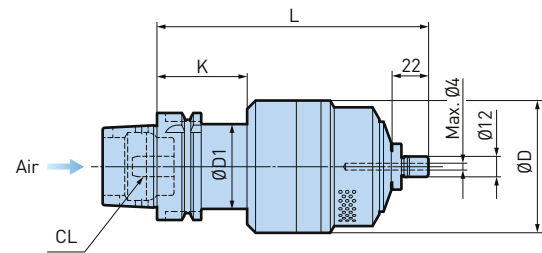





A.3

Model	Order No.	Operation Speed (min-1)	ØD	ØD1	L	K	Nut Model
HSK-A63-RBX5C-4S-160	965.506	40000 - 50000	96	50	160	53	MGN4S
HSK-A63-RBX7C-4S-160	965.505	60000 - 80000	78	50	160	53	MGN4S
HSK-A100-RBX5C-4S-165	802.427	40000 - 50000	96	68	165	58	MGN4S
HSK-A100-RBX7C-4S-165	802.430	60000 - 80000	78	68	165	58	MGN4S

1. Nut and wrench are included.
2. Collet (NBC4S-_) and XF1 (air unit) are to be ordered separately.
3. Coolant pipe (CL) is to be ordered separately.
4. Dry and clean air is an essential condition for the use of this product. Therefore, coolant should never be supplied through the spindle of the machine using the Air Turbine Spindle.

Accessories & Spare Parts

<p>MEGA Nuts</p>  <p>▶ 326</p>	<p>Micro Collets</p>  <p>▶ 324</p>	<p>MEGA Wrenches</p>  <p>▶ 351</p>	<p>Air Filter Regulator for RBX</p>  <p>▶ 366</p>
---	---	---	--

Air Turbine Spindle

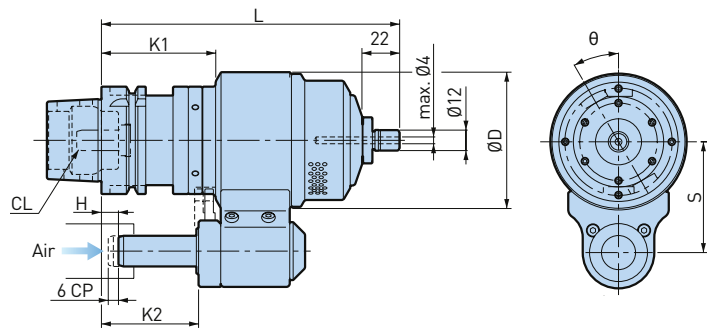

A.3

Model	Order No.	Operation Speed (min-1)	ØD	L	K1	K2	S	H	Nut Model
HSK-A63-RBX5-4S-175-65	802.431	40000 - 50000	96	175	67	57	65	0 - 45	MGN4S
HSK-A63-RBX7-4S-175-65	802.433	60000 - 80000	80	175	67	57	65	0 - 45	MGN4S
HSK-A100-RBX5-4S-180-80	802.425	40000 - 50000	100	180	72	62	80	5 - 50	MGN4S
HSK-A100-RBX7-4S-180-80	802.428	60000 - 80000	100	180	72	62	80	5 - 50	MGN4S

1. Exclusive Stop Block is required.
2. Nut and wrench are included.
3. Collet (NBC4S-_) and XF1 (air unit) are to be ordered separately.
4. Coolant pipe (CL) is to be ordered separately.
5. Dry and clean air is an essential condition for the use of this product. Therefore, coolant should never be supplied through the spindle of the machine using the Air Turbine Spindle.
6. „CP” indicates compression.
7. θ: Drive grooves adjustable 0 - 360°.

Accessories & Spare Parts

<p>MEGA Nuts</p> <p>▶ 326</p>	<p>Micro Collets</p> <p>▶ 324</p>	<p>MEGA Wrenches</p> <p>▶ 351</p>	<p>Semi-Finished Stop Blocks</p> <p>▶ 377</p>	<p>Air Filter Regulator for RBX</p> <p>▶ 366</p>
--------------------------------------	--	--	--	---

Air Turbine Spindle Manual Type

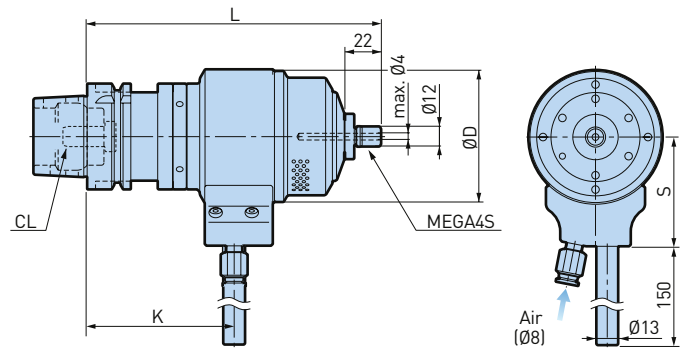





A.3

Model	Order No.	Operation Speed (min-1)	ØD	L	K	S	Nut Model
HSK-A63-RBX5-4S-175H	802.432	40000 - 50000	96	175	87	65	MGN4S
HSK-A63-RBX7-4S-175H	802.434	60000 - 80000	80	175	87	65	MGN4S
HSK-A100-RBX5-4S-180H	802.426	40000 - 50000	100	180	92	80	MGN4S
HSK-A100-RBX7-4S-180H	802.429	60000 - 80000	100	180	92	80	MGN4S

1. Nut and wrench are included.
2. Collet (NBC4S-_) and XF1 (air unit) are to be ordered separately.
3. Dry and clean air is an essential condition for the use of this product. Therefore, coolant should never be supplied through the spindle of the machine using the Air Turbine Spindle.
4. Coolant pipe (CL) is to be ordered separately.

Accessories & Spare Parts

<p>MEGA Nuts</p>  <p>▶ 326</p>	<p>Micro Collets</p>  <p>▶ 324</p>	<p>MEGA Wrenches</p>  <p>▶ 351</p>	<p>Air Filter Regulator for RBX</p>  <p>▶ 366</p>
---	---	---	--

MEGA Micro Chuck Type T

Tapered and slim design, minimal interference combined with maximized rigidity.

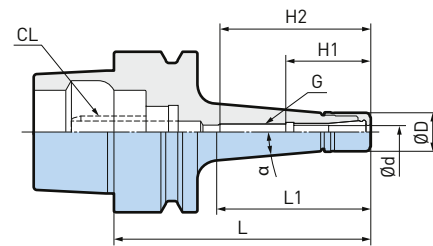

A.3

ø0.45 - 8.05mm

Model	Order No.	ød	øD	L	L1	H1	H2	G	α	max. min-1	Collet Model
HSK-E25-MEGA3S-45T *	968.870	0.45 - 3.25	10	45	32	22	32	-	5°	50000	NBC3S
HSK-E25-MEGA3S-60T	968.871	0.45 - 3.25	10	60	48	22	38	M4 P0.7	5°	40000	NBC3S
HSK-E25-MEGA4S-45T *	968.872	0,45 - 4,05	12	45	33	26.5	32	-	5°	50000	NBC4S
HSK-E25-MEGA4S-60T	968.873	0,45 - 4,05	12	60	49	26.5	41	M5 P0.8	5°	40000	NBC4S
HSK-E25-MEGA6S-45T *	968.874	• 0.45 - 6.05	14	45	33	28.5	31	-	5°	50000	NBC6S
HSK-E25-MEGA6S-60T	968.875	• 0.45 - 6.05	14	60	49	28.5	40	M7 P0.75	5°	40000	NBC6S
HSK-E32-MEGA3S-60T	968.917	0.45 - 3.25	10	60	35	22	38	M4 P0.7	5°	40000	NBC3S
HSK-E32-MEGA3S-75T	968.918	0.45 - 3,25	10	75	50	22	38	M4 P0.7	5°	40000	NBC3S
HSK-E32-MEGA4S-45T *	968.880	0.45 - 4.05	12	45	23	26.5	26	-	5°	50000	NBC4S
HSK-E32-MEGA4S-60T	968.881	0.45 - 4.05	12	60	35	26.5	46	M5 P0.8	5°	40000	NBC4S
HSK-E32-MEGA6S-45T *	968.882	• 0.45 - 6.05	14	45	23	28.5	28	-	5°	50000	NBC6S
HSK-E32-MEGA6S-60T	968.883	• 0.45 - 6.05	14	60	36	28.5	38	M7 P0.75	5°	30000	NBC6S
HSK-E32-MEGA8S-60T *	803.604	2.95 - 8.05	18	60	38	31	43	-	5°	40000	NBC8S
HSK-E40-MEGA3S-60T	968.919	0.45 - 3.25	10	60	35	22	39	M4 P0.7	5°	40000	NBC3S
HSK-E40-MEGA3S-75T	968.920	0.45 - 3.25	10	75	50	22	38	M4 P0.7	5°	40000	NBC3S
HSK-E40-MEGA4S-60T	968.890	0.45 - 4.05	12	60	35	26.5	44	M5 P0.8	5°	40000	NBC4S
HSK-E40-MEGA4S-75T	968.891	0.45 - 4.05	12	75	50	26.5	47	M5 P0.8	5°	40000	NBC4S
HSK-E40-MEGA6S-60T *	968.892	• 0.45 - 6.05	14	60	35	28.5	42	-	5°	40000	NBC6S
HSK-E40-MEGA6S-75T	968.893	• 0.45 - 6.05	14	75	50	28.5	49	M7 P0.75	5°	40000	NBC6S
HSK-E40-MEGA6S-90T	968.894	0.45 - 6.05	14	90	65	28.5	49	M7 P0.75	5°	40000	NBC6S
HSK-E50-MEGA3S-80T	968.921	0,45 - 3,25	10	80	49	22	38	M4 P0.7	5°	40000	NBC3S
HSK-E50-MEGA4S-80T	968.906	0,45 - 4,05	12	80	48	26,5	47	M5 P0.8	5°	40000	NBC4S
HSK-E50-MEGA6S-80T	968.907	0.45 - 6.05	14	80	49	28.5	49	M7 P0.75	5°	40000	NBC6S
HSK-E50-MEGA6S-120T	806.636	0.45 - 6.05	14	120	89	28.5	49	M7 P0.75	5°	35000	NBC6S

1. MEGA nut is included in delivery.
2. * Internal thread (G) is not available.
3. Coolant pipe (CL) is to be ordered separately.

Accessories & Spare Parts

<p>MEGA Nuts</p> <p>▶ 326</p>	<p>Micro Seal Nuts</p> <p>▶ 326</p>	<p>Micro Collets</p> <p>▶ 324</p>	<p>MEGA Wrenches</p> <p>▶ 351</p>	<p>Taper Cleaners</p> <p>▶ 370</p>	<p>Collet Protective Cases</p> <p>▶ 326</p>	<p>Coolant Pipes</p> <p>▶ 228</p>
--------------------------------------	--	--	--	---	--	--

MEGA Micro Chuck Type S

Micro diameter design is ideal for high speed applications in tight areas.

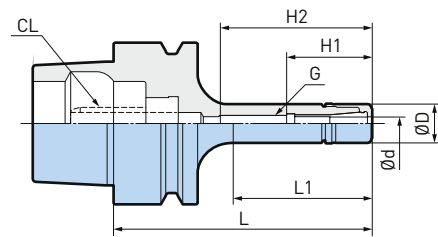
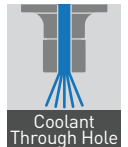

A.3

ø0.45 - 6.05mm

Model	Order No.	Ød	ØD	L	L1	H1	H2	G	max. min-1	Collet Model
HSK-E20-MEGA3S-33B **	101017.001.0	0.45 - 3.25	10	33	25	24	-	-	60000	NBC3S
HSK-E20-MEGA4S-33B **	101017.002.0	0.45 - 4.05	12	33	25	26,5	-	-	60000	NBC4S
HSK-E20-MEGA6S-35B **	101017.003.0	0.45 - 6.05	14	35	27	28,5	-	-	60000	NBC6S
HSK-E25-MEGA4S-45 *	968.866	0,45 - 4,05	12	45	31	26,5	32	-	50000	NBC4S
HSK-E25-MEGA4S-60	968.867	0,45 - 4,05	12	60	46	26,5	42	M5 P0.8	40000	NBC4S
HSK-E25-MEGA6S-45 *	968.868	0.45 - 6.05	14	45	32	28	31	-	50000	NBC6S
HSK-E25-MEGA6S-60	968.869	0.45 - 6.05	14	60	47	28.5	41	M7 P0.75	40000	NBC6S
HSK-E32-MEGA3S-45 *	968.914	0.45 - 3.25	10	45	23	22	31	-	50000	NBC3S
HSK-E32-MEGA4S-45	968.876	0.45 - 4.05	12	45	22	26.5	31	M5 P0.8	50000	NBC4S
HSK-E32-MEGA4S-60	968.877	0.45 - 4.05	12	60	34	26.5	46	M5 P0.8	40000	NBC4S
HSK-E32-MEGA6S-45 *	968.878	0.45 - 6.05	14	45	22	28.5	28	-	50000	NBC6S
HSK-E32-MEGA6S-60	968.879	• 0.45 - 6.05	14	60	35	28.5	38	M7 P0.75	40000	NBC6S
HSK-E40-MEGA3S-40 *	968.915	0.45 - 3.25	10	40	19	22	24	-	50000	NBC3S
HSK-E40-MEGA4S-60	968.756	0,45 - 4,05	12	60	34	26,5	44	M5 P0.8	40000	NBC4S
HSK-E40-MEGA6S-45 *	968.716	• 0.45 - 6.05	14	45	23	27.5	27	-	50000	NBC6S
HSK-E40-MEGA6S-60 *	968.757	0.45 - 6.05	14	60	35	28.5	42	-	40000	NBC6S
HSK-E50-MEGA3S-50	968.916	0,45 - 3,25	10	50	20	22	30	-	45000	NBC3S
HSK-E50-MEGA4S-50	968.725	0,45 - 4,05	12	50	21	26,5	30	-	45000	NBC4S
HSK-E50-MEGA4S-80	968.759	0,45 - 4,05	12	80	44	26,5	47	M5 P0.8	40000	NBC4S
HSK-E50-MEGA6S-55 *	978.100	0.45 - 6.05	14	55	26	28.5	35	-	45000	NBC6S
HSK-E50-MEGA6S-80	968.760	0.45 - 6.05	14	80	44	28.5	49	M7 P0.75	40000	NBC6S

1. MEGA nut is included in delivery.
2. Coolant pipe (CL) is to be ordered separately.
3. * Internal thread (G) is not available.
4. Center through coolant is not available for HSK-E20 tools
5. MEGA Micro Collet and MEGA Wrench are to be purchased separately.

Accessories & Spare Parts

<p>MEGA Nuts</p> <p>▶ 326</p>	<p>Micro Seal Nuts</p> <p>▶ 326</p>	<p>Micro Collets</p> <p>▶ 324</p>	<p>MEGA Wrenches</p> <p>▶ 351</p>	<p>Taper Cleaners</p> <p>▶ 370</p>	<p>Collet Protective Cases</p> <p>▶ 326</p>	<p>Coolant Pipes</p> <p>▶ 228</p>
--------------------------------------	--	--	--	---	--	--

MEGA New Baby Chuck

Ideal ultra precision collet holders for high speed machining. Wide range of lengths and a variety of collet series covers all machining applications.

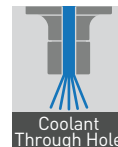

A.3



ø0.25 - 20mm

Model	Order No.	Fig.	Ød	ØD	L	L1	H	max. min-1	Collet Model
HSK-E25-MEGA6N-40 *	968.752	1	0.25 - 6	20	40	29	25	30000	NBC6
HSK-E25-MEGA8N-45 *	968.753	2	0.5 - 8	25	45	-	30	25000	NBC8
HSK-E25-MEGA10N-60 **	968.754	2	1.5 - 10	30	60	-	45	20000	NBC10
HSK-E32-MEGA6N-45 *	968.884	1	0.25 - 6	20	45	24	28	40000	NBC6
HSK-E32-MEGA6N-60	968.885	1	0.25 - 6	20	60	37	23 - 27	35000	NBC6
HSK-E32-MEGA8N-50 *	968.886	1	0.5 - 8	25	50	29	33	40000	NBC8
HSK-E32-MEGA8N-65	968.887	1	0.5 - 8	25	65	44	26 - 32	35000	NBC8
HSK-E32-MEGA10N-65 *	968.888	2	1.5 - 10	30	65	-	47	30000	NBC10
HSK-E32-MEGA13N-70 *	968.889	2	2.5 - 13	35	70	-	44	25000	NBC13
HSK-E40-MEGA6N-50 *	968.717	1	0.25 - 6	20	50	26	31	40000	NBC6
HSK-E40-MEGA6N-60	968.895	1	0.25 - 6	20	60	34	23 - 26	35000	NBC6
HSK-E40-MEGA6N-75	968.718	1	0.25 - 6	20	75	49	23 - 41	30000	NBC6
HSK-E40-MEGA6N-90	968.896	1	0.25 - 6	20	90	64	23 - 43	28000	NBC6
HSK-E40-MEGA6N-120	968.897	1	0.25 - 6	20	120	94	23 - 43	25000	NBC6
HSK-E40-MEGA8N-55 *	968.719	1	0.5 - 8	25	55	31	36	40000	NBC8
HSK-E40-MEGA8N-75	968.720	1	0.5 - 8	25	75	51	26 - 41	30000	NBC8
HSK-E40-MEGA8N-90	968.898	1	0.5 - 8	25	90	66	26 - 45	28000	NBC 8
HSK-E40-MEGA10N-60 *	968.721	1	1.5 - 10	30	60	37	40	35000	NBC10
HSK-E40-MEGA10N-75 *	968.899	1	1.5 - 10	30	75	52	55	30000	NBC10
HSK-E40-MEGA10N-90	968.722	1	1.5 - 10	30	90	67	38 - 48	28000	NBC10
HSK-E40-MEGA13N-65 *	968.900	1	2.5 - 13	35	65	44	44	30000	NBC13
HSK-E40-MEGA13N-75	968.723	1	2.5 - 13	35	75	54	55	25000	NBC13
HSK-E40-MEGA13N-90	968.901	1	2.5 - 13	35	90	69	44 - 48	25000	NBC13
HSK-E40-MEGA13N-120	968.902	1	2.5 - 13	35	120	99	44 - 63	20000	NBC13
HSK-E40-MEGA13N-150	968.903	1	2.5 - 13	35	150	129	44 - 63	15000	NBC13
HSK-E40-MEGA16N-65	968.904	1	2.5 - 16	42	65	-	46	25000	NBC16
HSK-E40-MEGA16N-75 *	968.905	2	2.5 - 16	42	75	-	48	20000	NBC16

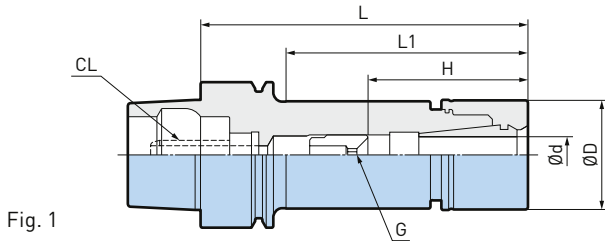

Fig. 1

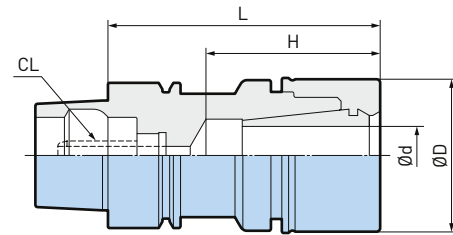









Fig. 2

Model	Order No.	Fig.	Ød	ØD	L	L1	H	max. min-1	Collet Model
HSK-E50-MEGA6N-55 *	968.727	1	0,25 - 6	20	55	27	35	40000	NBC6
HSK-E50-MEGA6N-70	968.728	1	0,25 - 6	20	70	38	23 - 39	30000	NBC6
HSK-E50-MEGA6N-100	968.761	1	0,25 - 6	20	100	64	23 - 43	25000	NBC6
HSK-E50-MEGA8N-60 *	968.729	1	0,5 - 8	25	60	30	37	40000	NBC8
HSK-E50-MEGA8N-90	968.730	1	0,5 - 8	25	90	56	26 - 45	30000	NBC8
HSK-E50-MEGA10N-60 **	968.731	1	1,5 - 10	30	60	30	35	35000	NBC10
HSK-E50-MEGA10N-90	968.732	1	1,5 - 10	30	90	58	38 - 48	30000	NBC10
HSK-E50-MEGA13N-70 *	968.733	1	2,5 - 13	35	70	40	45	28000	NBC13
HSK-E50-MEGA13N-90	968.734	1	2,5 - 13	35	90	60	44 - 47	25000	NBC13
HSK-E50-MEGA13N-120	968.763	1	2,5 - 13	35	120	90	44 - 63	20000	NBC13
HSK-E50-MEGA13N-150	968.910	1	2,5 - 13	35	150	120	44 - 63	15000	NBC13
HSK-E50-MEGA16N-75 *	968.735	1	2,5 - 16	42	75	48	52	28000	NBC16
HSK-E50-MEGA16N-90 *	968.736	1	2,5 - 16	42	90	63	65	25000	NBC16
HSK-E50-MEGA20N-75 **	968.764	1	2,5 - 20	46	75	-	49	25000	NBC20
HSK-E50-MEGA20N-100	968.911	1	2,5 - 20	46	100	-	51 - 54	20000	NBC20
HSK-E50-MEGA20N-130	968.912	1	2,5 - 20	46	130	-	51 - 68	18000	NBC20

1. MEGA nut is included in delivery.
2. Coolant pipe [CL] is to be ordered separately.
3. * Adjusting screw cannot be used.
4. ** NBC-E collet and adjusting screw can not be used.
5. "G" is the adjusting screw (optional).
6. "H" is the max. tool shank length that can be inserted for these models.

Accessories & Spare Parts

<p>MEGA Nuts</p>  <p>▶ 334</p>	<p>MEGA Perfect Seals</p>  <p>▶ 336</p>	<p>New Baby Collets</p>  <p>▶ 327</p>	<p>MEGA Wrenches</p>  <p>▶ 351</p>	<p>Adjusting Screws NBA</p>  <p>▶ 335</p>	<p>Taper Cleaners</p>  <p>▶ 370</p>	<p>Coolant Pipes</p>  <p>▶ 228</p>
---	--	--	---	---	--	---

Hydraulic Chuck Super Slim

Ultra precise hydraulic chuck with extremely slim design.



A.3

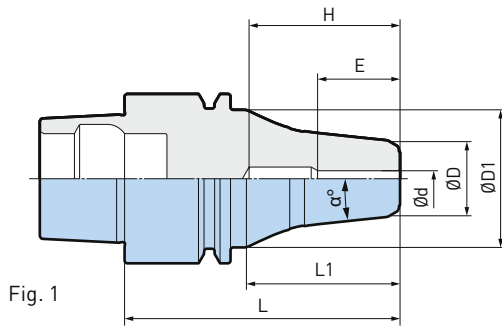

Fig. 1

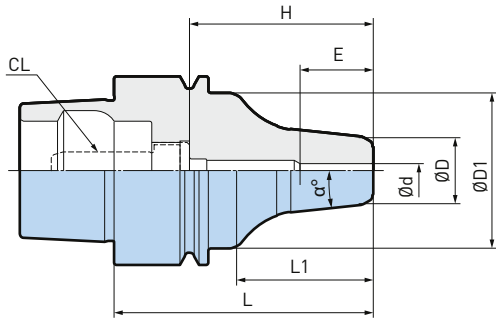

Fig. 2

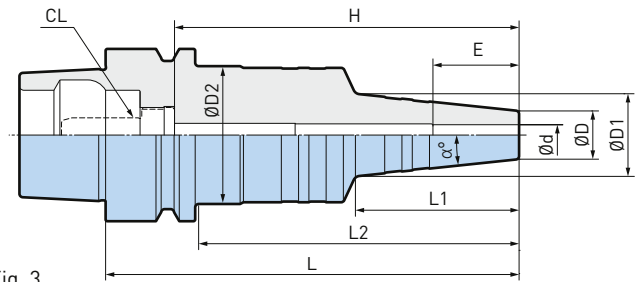

Fig. 3

ø3 - 12mm

Model	Order No.	Fig.	Ød	ØD	ØD1	ØD2	L	L1	L2	E	α	max. min-1
HSK-E25-HDC3S-40	806.430	1	3	14	20	-	40	27	-	16	6°	60000
HSK-E25-HDC4S-40	806.431	1	4	14	20	-	40	27	-	16	6°	60000
HSK-E25-HDC6S-45	806.734	1	6	14	23	-	45	31	-	16	8°	60000
HSK-E32-HDC3S-52	805.471	1	3	14	26	-	52	29	-	16	6°	45000
HSK-E32-HDC4S-52	805.472	1	4	14	26	-	52	29	-	19	6°	45000
HSK-E32-HDC6S-57	805.473	1	6	14	26	-	57	34	-	25	6°	45000
HSK-E40-HDC3S-55	805.474	2	3	14	33	-	55	29	-	16	6°	40000
HSK-E40-HDC4S-55	805.475	2	4	14	33	-	55	29	-	19	6°	40000
HSK-E40-HDC4S-75	100132.007.0	3	4	14	33	-	75	40	-	19	6°	40000
HSK-E40-HDC6S-60	805.476	2	6	14	33	-	60	34	-	25	6°	40000
HSK-E40-HDC6S-75	100132.008.0	3	6	14	33	-	75	40	-	25	6°	40000
HSK-E40-HDC8S-65	807.252	2	8	17	33	-	65	39	-	31	6°	35000
HSK-E40-HDC10S-70	807.168	2	10	19	33	-	70	40	-	33	6°	35000
HSK-E40-HDC12S-70	807.253	2	12	21	33	-	70	40	-	36	6°	35000
HSK-E50-HDC4S-120	807.115	3	4	14	24	40	120	47	93	19	6°	30000
HSK-E50-HDC6S-120	807.088	3	6	14	24	40	120	47	93	25	6°	30000
HSK-E50-HDC8S-120	807.089	3	8	17	28	40	120	48	93	31	6°	30000
HSK-E50-HDC10S-120	807.090	3	10	19	30	40	120	48	93	33	6°	30000
HSK-E50-HDC12S-120	807.091	3	12	21	32	40	120	49	93	36	6°	30000

1. Adjusting screw cannot be used.
2. "E" is the min. clamping length.
3. "H" is the max. tool shank length that can be inserted for these models.
4. Center through coolant is available for HSK-E40 and HSK-E50.

Caution

- Use only cutting tools that have a shank tolerance within h6.
- Roughing endmills are not recommended for use with hydraulic chucks.
- Do not use with cutting tools made with a flat on the shank. (ie: Weldon type shank)
- Do not tighten the clamping screw without first inserting a cutting tool into the hydraulic chuck.
- Always insert the cutting tool into the hydraulic chuck beyond min. clamping length E.

Accessories & Spare Parts

<p>Wiper Cleaners</p> <p>► 370</p>	<p>Coolant Pipes</p> <p>► 228</p>
------------------------------------	-----------------------------------

Hydraulic Chuck Ultra Precision Type

The most accurate hydraulic chuck made is based on decades of experience and know-how. Guaranteed runout of less than 1µm in 4D.



A.3

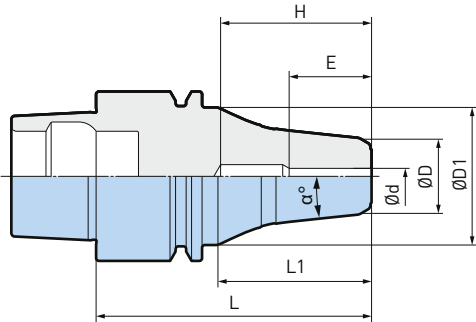

Fig. 1

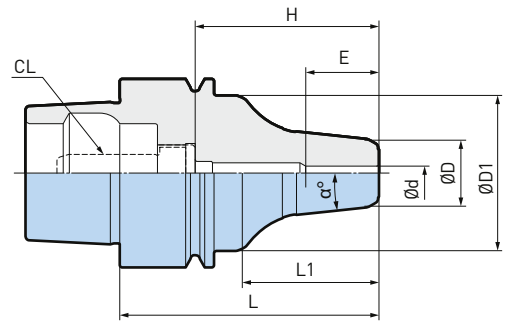

Fig. 2

ø3 - 6mm

Model	Order No.	Fig.	Ød	ØD	ØD1	L	L1	α	E	H	max. min-1
HSK-E25-HDC3S-40UP	806.907	1	3	14	20	40	27	6°	16	22	60000
HSK-E25-HDC4S-40UP	806.908	1	4	14	20	40	27	6°	16	21	60000
HSK-E25-HDC6S-45UP	807.120	1	6	14	23	45	31	8°	21	26	60000
HSK-E32-HDC3S-52UP	806.909	1	3	14	26	52	29	6°	16	28	45000
HSK-E32-HDC4S-52UP	806.910	1	4	14	26	52	29	6°	19	28	45000
HSK-E32-HDC6S-57UP	806.911	1	6	14	26	57	34	6°	25	33	45000
HSK-E40-HDC3S-55UP	807.123	2	3	14	33	55	29	6°	16	39	40000
HSK-E40-HDC4S-55UP	807.125	2	4	14	33	55	29	6°	19	39	40000
HSK-E40-HDC6S-60UP	807.126	2	6	14	33	60	34	6°	25	40	40000

1. Coolant pipe (CL) is to be ordered separately.
2. Adjusting screw cannot be used.
3. "E" is the min. clamping length.
4. "H" is the max. tool shank length that can be inserted for these models.
5. Center through coolant is available for HSK-E40 and HSK-E50.

Caution

- Use only cutting tools that have a shank tolerance within h6.
- Roughing endmills are not recommended for use with hydraulic chucks.
- Do not use with cutting tools made with a flat on the shank. (ie: Weldon type shank)
- Do not tighten the clamping screw without first inserting a cutting tool into the hydraulic chuck.
- Always insert the cutting tool into the hydraulic chuck beyond min. clamping length E.

Accessories & Spare Parts

<p>Wiper Cleaners</p> <p>► 370</p>	<p>Coolant Pipes</p> <p>► 228</p>
------------------------------------	-----------------------------------

CK Shanks with Center Through Hole

Symmetrical version for high speed machine spindles.

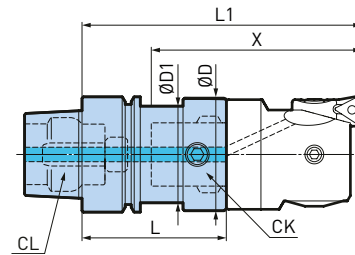
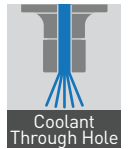

A.3

CK1 - CK5

Model	Order No.	CK	ØD	ØD1	L	L1	X
HSK-E25-CKB1-22 **	328.249F	CKB1	19	19	22	55	40
HSK-E25-CKB2-30 *	328.281F	CKB2	24	24	30	66	50
HSK-E32-CKB1-40	328.257F	CKB1	19	19	40	73	50
HSK-E32-CKB2-33	328.280F	CKB2	24	24	33	69	43
HSK-E32-CKB3-48	328.151F	CKB3	31	25.8	48	88	68
HSK-E32-CKB4-68	328.218F	CKB4	39	26	68	115	90
HSK-E40-CKB1-32	324.111F	CKB1	19	19	31.5	64	40
HSK-E40-CKB2-35	324.121F	CKB2	24	24	35	71	45
HSK-E40-CKB3-40	324.131F	CKB3	31	31	40	80	55
HSK-E40-CKB4-50	324.141F	CKB4	39	33	50	97	72
HSK-E50-CKB3-44	324.231F	CKB3	31	31	44	84	53
HSK-E50-CKB4-48	324.241F	CKB4	39	39	48	95	64
HSK-E50-CKB5-61	324.251F	CKB5	50	41	61	118	87

1. X and L1 dimensions on the table are reference figures when EWN/EWE head is mounted.
2. * ØD1 does not comply with the HSK standard.
3. ** Center through coolant is not available.
4. All shanks are precision balanced (± 2 gmm).
5. Coolant pipe (CL) is to be ordered separately.

Accessories & Spare Parts

<p>Coolant Pipes</p> <p>► 228</p>	<p>Fine Boring Heads</p> <p>► 396-399</p>
-----------------------------------	---

MEGA Micro Chuck Type T

Tapered and slim design, minimal interference combined with maximized rigidity.

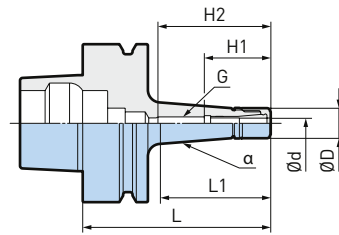
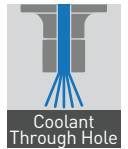

A.3

ø0.45 - 8.05mm

Model	Order No.	Ød	ØD	L	L1	H1	H2	G	α	max. min-1	Collet Model
HSK-F63-MEGA4S-75T	803.588	0,45 - 4,05	12	75	44	26,5	41	M5 P0.8	5°	32000	NBC4S
HSK-F63-MEGA6S-75T	803.589	0.45 - 6.05	14	75	44	28.5	41	M7 P0.75	5°	32000	NBC6S
HSK-F63-MEGA8S-75T	805.576	2.95 - 8.05	18	75	44	31	58	M9 P0.75	5°	32000	NBC8S

1. MEGA nut is included in delivery.
2. Coolant pipe (CL) is to be ordered separately.

MEGA Micro Chuck Type S

Slim design for tight spaces.

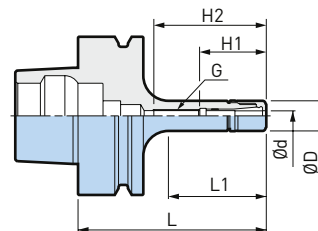
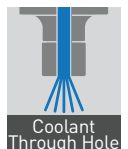

ø0.45 - 6.05mm

Model	Order No.	Ød	ØD	L	L1	H1	H2	G	max. min-1	Collet Model
HSK-F63-MEGA4S-75	803.586	0,45 - 4,05	12	75	39	26,5	41	M5 P0.8	30000	NBC4S
HSK-F63-MEGA4S-105	803.590	0,45 - 4,05	12	105	76	26,5	47	M5 P0.8	25000	NBC4S
HSK-F63-MEGA6S-75	803.587	0,45 - 6,05	14	75	46	28,5	41	M7 P0.75	30000	NBC6S
HSK-F63-MEGA6S-90	803.592	0.45 - 6.05	14	90	61	28.5	49	M7 P0.75	27000	NBC6S
HSK-F63-MEGA6S-105	803.591	0.45 - 6.05	14	105	76	28.5	49	M7 P0.75	25000	NBC6S

1. MEGA nut is included in delivery.
2. Coolant pipe (CL) is to be ordered separately.

Accessories & Spare Parts

MEGA Nuts	Micro Seal Nuts	Micro Collets	MEGA Wrenches	Taper Cleaners	Collet Protective Cases	Coolant Pipes
▶ 326	▶ 326	▶ 324	▶ 351	▶ 370	▶ 326	▶ 228

MEGA New Baby Chuck

Ideal ultra precision collet holders for high speed machining. Wide range of lengths and a variety of collet series covers all machining applications.

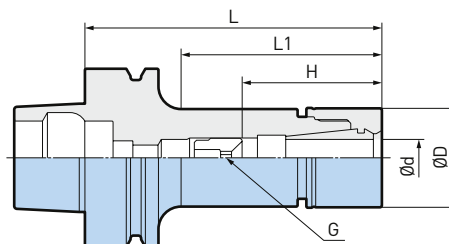
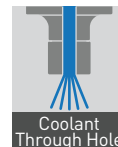

A.3

ø0.25 - 20mm

Model	Order No.	Ød	ØD	L	L1	H	max. min-1	Collet Model
HSK-F63-MEGA6N-75	978.195	0,25 - 6	20	75	42	23 - 31	35000	NBC6
HSK-F63-MEGA6N-90	801.287	0.25 - 6	20	90	53	23 - 43	30000	NBC6
HSK-F63-MEGA6N-105	801.286	0,25 - 6	20	105	69	23 - 43	25000	NBC6
HSK-F63-MEGA6N-135	801.677	0.25 - 6	20	135	99	23 - 43	20000	NBC6
HSK-F63-MEGA8N-75	801.668	0,5 - 8	25	75	43	26 - 38	32000	NBC8
HSK-F63-MEGA8N-90	978.199	0.5 - 8	25	90	54	26 - 45	30000	NBC8
HSK-F63-MEGA8N-105	801.288	0,5 - 8	25	105	69	26 - 45	28000	NBC8
HSK-F63-MEGA8N-120	804.962	0.5 - 8	25	120	84	26 - 45	25000	NBC8
HSK-F63-MEGA8N-165	803.631	0,5 - 8	25	165	129	26 - 45	15000	NBC8
HSK-F63-MEGA10N-75 *	978.189	1,5 - 10	30	75	43	48	32000	NBC10
HSK-F63-MEGA10N-90	978.146	1.5 - 10	30	90	54	38 - 48	30000	NBC10
HSK-F63-MEGA10N-105	801.282	1,5 - 10	30	105	69	38 - 48	25000	NBC10
HSK-F63-MEGA10N-120	978.152	1.5 - 10	30	120	84	38 - 48	25000	NBC10
HSK-F63-MEGA13N-75 *	978.190	2,5 - 13	35	75	43	47	30000	NBC13
HSK-F63-MEGA13N-90 *	978.215	2.5 - 13	35	90	56	61	30000	NBC13
HSK-F63-MEGA13N-105	801.283	2,5 - 13	35	105	71	44 - 53	25000	NBC13
HSK-F63-MEGA13N-120	801.284	2,5 - 13	35	120	86	44 - 63	20000	NBC13
HSK-F63-MEGA13N-165	801.285	2,5 - 13	35	165	131	44 - 63	15000	NBC13
HSK-F63-MEGA16N-75 *	978.102	2,5 - 16	42	75	43	48	30000	NBC16
HSK-F63-MEGA16N-90 *	978.151	2.5 - 16	42	90	58	61	25000	NBC16
HSK-F63-MEGA16N-105	978.123	2,5 - 16	42	105	73	48 - 56	20000	NBC16
HSK-F63-MEGA20N-75 *	978.047	2,5 - 20	46	75	45	51	30000	NBC20
HSK-F63-MEGA20N-90 *	978.147	2.5 - 20	46	90	60	61	25000	NBC20
HSK-F63-MEGA20N-105	978.124	2,5 - 20	46	105	75	51 - 58	20000	NBC20

1. MEGA nut is included in delivery.
2. * Adjusting screws can not be used. "H" is the max. tool shank length that can be inserted for these models.
3. Coolant pipe [CL] is to be ordered separately.
4. "G" is the adjusting screw [optional].
5. "H" is the max. tool shank length that can be inserted for these models.

Accessories & Spare Parts

<p>MEGA Nuts</p> <p>▶ 334</p>	<p>MEGA Perfect Seals</p> <p>▶ 336</p>	<p>New Baby Collets</p> <p>▶ 327</p>	<p>MEGA Wrenches</p> <p>▶ 351</p>	<p>Adjusting Screws NBA</p> <p>▶ 335</p>	<p>Taper Cleaners</p> <p>▶ 370</p>	<p>Coolant Pipes</p> <p>▶ 228</p>
--------------------------------------	---	---	--	---	---	--

MEGA E Chuck

Collet chuck designed exclusively for endmilling with high concentricity and rigidity.

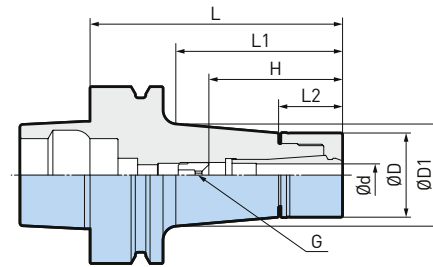
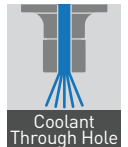

A.3

ø3 - 12mm

Model	Order No.	Ød	ØD	ØD1	L	L1	L2	H	max. min-1	Collet Model
HSK-F63-MEGA6E-65 *	803.214	3 - 6	25	28.5	65	34	21	39	30000	MEC6
HSK-F63-MEGA6E-90	803.215	3 - 6	25	31.5	90	58	21	37 - 45	30000	MEC6
HSK-F63-MEGA8E-65 *	803.218	3 - 8	30	33	65	34	22.5	41	30000	MEC8
HSK-F63-MEGA8E-90	802.338	3 - 8	30	36.5	90	59	22,5	42 - 47	30000	MEC8
HSK-F63-MEGA10E-75 *	803.207	3 - 10	35	38.5	75	44	23	48	30000	MEC10
HSK-F63-MEGA10E-90 *	803.208	3 - 10	35	41.5	90	59	23	67	30000	MEC10
HSK-F63-MEGA10E-105	803.209	3 - 10	35	44	105	75	23	48 - 58	29000	MEC10
HSK-F63-MEGA10E-120	803.213	3 - 10	35	47	120	91	23	48 - 58	29000	MEC10
HSK-F63-MEGA10E-135	803.217	3 - 10	35	49	135	107	23	48 - 58	27000	MEC10
HSK-F63-MEGA13E-75 *	803.210	3 - 12	42	46	75	47	25	50	30000	MEC13
HSK-F63-MEGA13E-90 *	803.211	3 - 12	42	48.5	90	62	25	64	30000	MEC13
HSK-F63-MEGA13E-105	803.212	3 - 12	42	51	105	78	25	50 - 58	29000	MEC13
HSK-F63-MEGA13E-135	803.216	3 - 12	42	52	135	108	25	50 - 60	26000	MEC13

1. MEGA E nut is included.
2. * Adjusting screws can not be used. "H" is the max. tool shank length that can be inserted for these models.
3. Coolant pipe (CL) is to be ordered separately.
4. "G" is the adjusting screw (optional).
5. "H" is the max. tool shank length that can be inserted for these models.

Accessories & Spare Parts

<p>MEGA E Nuts</p> <p>▶ 340</p>	<p>MEGA E Perfect Seals</p> <p>▶ 341</p>	<p>MEGA E Collets</p> <p>▶ 340</p>	<p>MEGA Wrenches</p> <p>▶ 351</p>	<p>Adjusting Screws NBA</p> <p>▶ 335</p>	<p>Taper Cleaners</p> <p>▶ 370</p>	<p>Coolant Pipes</p> <p>▶ 228</p>
--	---	---	--	---	---	--

MEGA Double Power Chuck Type D

Close to integral rigidity and precision of a solid tool holder. Flange contacting nut assures highest rigidity. Type D for use with/without coolant-through the tool.

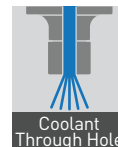

A.3

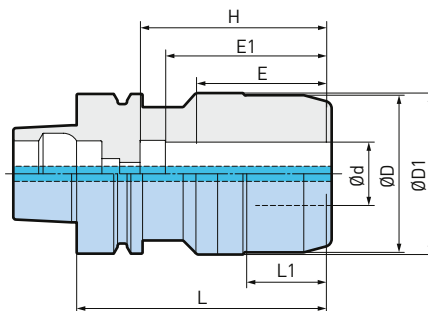





ø3 - 32mm

Model	Order No.	Ød	ØD	ØD1	L	L1	H	E	E1	max. min-1
HSK-F63-MEGA16D-80A	803.092	16	42	52.6	80	25	55	48	50	28000
HSK-F63-MEGA20D-90A	803.093	20	50	55	90	34	65	50	56	28000
HSK-F63-MEGA25D-100A	803.103	25	62	62.7	100	39	75	56	57	25000
HSK-F63-MEGA32D-105A	803.082	32	70	70.7	105	33.5	80	60	64	24000

1. Wrench and coolant pipe (CL) is to be ordered separately.
2. "E" is the min. clamping length.
3. "E1" is the min. clamping length for optimum use with center through coolant.
4. "H" is the max. tool shank length that can be inserted for these models.

Accessories & Spare Parts

PJC Collets	OCA Collets	PSC Collets	C Collets	MEGA Wrenches	Coolant Pipes
					
▶ 347	▶ 348	▶ 348	▶ 349	▶ 351	▶ 228

MEGA Double Power Chuck Type DS

Close to integral rigidity and precision of a solid tool holder. Flange contacting nut assures highest rigidity. Unique coolant supply design ensures efficient coolant supply to the cutting tool periphery.

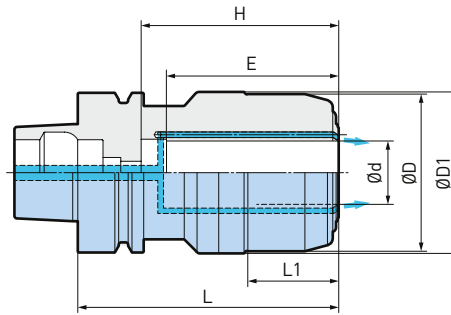





A.3

ø3 - 32mm

Model	Order No.	Ød	ØD	ØD1	L	L1	H	E	max. min-1
HSK-F63-MEGA16DS-80A	803.095	16	42	52.6	82	27	57	50	28000
HSK-F63-MEGA20DS-90A	803.096	20	50	55	92	36	67	56	28000
HSK-F63-MEGA25DS-100A	803.104	25	62	62.7	102	41	77	57	25000
HSK-F63-MEGA32DS-105A	803.083	32	70	70.7	107	35.5	82	64	24000

1. Wrench and coolant pipe (CL) is to be ordered separately.
2. "H" is the max. tool shank length that can be inserted for these models.
3. "E" is the min. clamping length.

Accessories & Spare Parts

PJC Collets	PSC Collets	OCA Collets	C Collets	MEGA Wrenches	Coolant Pipes
					
▶ 347	▶ 348	▶ 348	▶ 349	▶ 351	▶ 228

Coolant Pipes

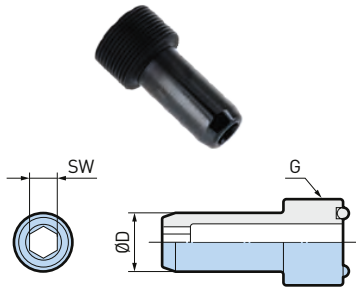

Model	Order No.	ØD	G	SW
HSK25-CP	978.921	5	M8 P1	2.5
HSK32-CP	978.909	6	M10 P1	3
HSK40-CP	978.913	8	M12 P1	4
HSK50-CP	801.071	10	M16 P1	5
HSK63-CP	969.475	12	M18 P1	6
HSK80-CP	802.828	14	M20 P1.5	8
HSK100-CP	802.351	16	M24 P1.5	8
HSK125-CP	805.684	18	M30 P1.5	10

A.3

Coolant Pipes 1° swing type (DIN) for Form A/E

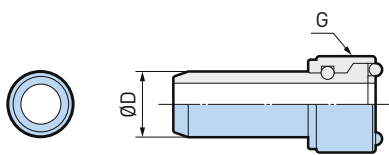

Model	Order No.	ØD	G	Wrench
HSK40-CPM	978.907	8	M12 P1	CPW-40
HSK50-CPM	801.690	10	M16 P1	CPW-50
HSK63-CPM	978.910	12	M18 P1	CPW-63
HSK80-CPM	802.827	14	M20 P1.5	CPW-80
HSK100-CPM	802.314	16	M24 P1.5	CPW-100
HSK125-CPM	806.594	18	M30 P1.5	CPW-125

Coolant Pipes Coolant Pipe Form F

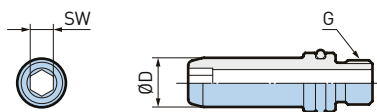

Model	Order No.	ØD	G	SW
HSKF63-CP	801.280	10	M9 P0.75	5

1. This model can be used for BIG KAISER Original Tool Holder only.

HSK Plug Screw

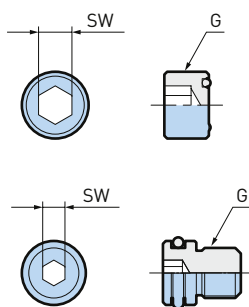

Model	Order No.	G	SW
HSK25-PG	807.215	M8 P1	4
HSK32-PG	807.216	M10 P1	5
HSK40-PG	807.189	M12 P1	6

1. In case our HSK tool holders are used in the machine which do not recommend the center through coolant, the plug screw should be mounted to our tools.

Model	Order No.	G	SW
HSK-F63-PG	807.190	M9 P0.75	4

1. In case our HSK tool holders are used in the machine which do not recommend the center through coolant, the plug screw should be mounted to our tools.
2. HSK-F63-PG can only be used in original BIG KAISER HSK-F63 tool holders, not compatible with other manufacturers.

Clamping Wrench

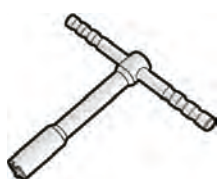

Model	Order No.
CPW-40	802.825
CPW-50	802.315
CPW-63	978.911
CPW-80	802.824
CPW-100	802.316

Caution

For machines capable of supplying coolant through spindle, the coolant pipe should be fitted to all HSK holders to protect against accidental selection of coolant.

Tool Holders BIG CAPTO, ISO 26623

MEGA Micro Chuck	230
MEGA New Baby Chuck	232
MEGA E Chuck	235
MEGA Double Power Chuck	237
New Hi-Power Milling Chuck	239
Hydraulic Chucks	240
Shrink Chucks	242
CK Shanks	243
Face Mill Arbors FMH	244
Side Lock Holders	245
Side Cutter Arbors / Morse Taper Holders	247
MEGA Synchro Tapping Holder	248
Extensions / Reductions	249
BBT / BIG CAPTO Basic Holders	249



MEGA Micro Chuck Type T

Tapered and slim design, minimal interference combined with maximized rigidity.

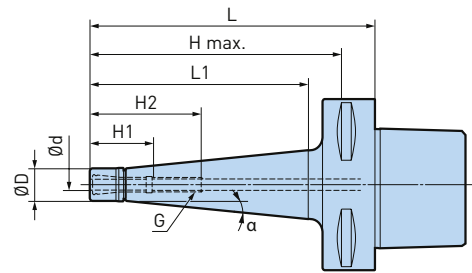
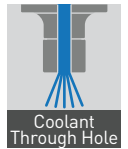







A.4

ø0.45 - 6.05mm

Model	Order No.	Ød	ØD	L	L1	H1	H2	H max.	G	α	Collet Model
C3-MEGA6S-45T	807.667	0.45 - 6.05	14	45	27	28	-	39	-	5°	NBC6S
C4-MEGA3S-60T	973.954	0.45 - 3.25	10	60	35	22	38	54	M4 P0.7	5°	NBC3S
C4-MEGA6S-60T	973.955	0.45 - 6.05	14	60	35	28	47	54	M7 P0.75	5°	NBC6S
C4-MEGA6S-90T	805.194	0.45 - 6.05	14	90	65	28	49	84	M7 P0.75	5°	NBC6S
C5-MEGA3S-105T	973.201	0,45 - 3,25	10	105	79	22,5	38.5	98	M4 P0.7	5°	NBC3S
C5-MEGA4S-105T	973.202	0,45 - 4,05	12	105	79	26,5	47	98	M5 P0.8	5°	NBC4S
C5-MEGA4S-120T	800.743	0,45 - 4,05	12	120	94	26,5	47	113	M5 P0.8	5°	NBC4S
C5-MEGA6S-105T	973.203	0.45 - 6.05	14	105	79	28.5	49	98	M7 P0.75	5°	NBC6S
C5-MEGA6S-120T	800.746	0.45 - 6.05	14	120	94	28.5	49	113	M7 P0.75	5°	NBC6S
C6-MEGA3S-120T	973.204	0.45 - 3.25	10	120	92	22.5	38.5	111	M4 P0.7	5°	NBC3S
C6-MEGA4S-120T	973.205	0.45 - 4.05	12	120	92	26.5	47	111	M5 P0.8	5°	NBC4S
C6-MEGA4S-135T	800.557	0.45 - 4.05	12	135	107	26.5	47	126	M5 P0.9	5°	NBC4S
C6-MEGA6S-120T	973.206	• 0.45 - 6.05	14	120	92	28.5	49	111	M7 P0.75	5°	NBC6S
C6-MEGA6S-135T	978.134	• 0.45 - 6.05	14	135	107	28.5	49	126	M7 P0.75	5°	NBC6S

1. MEGA nut is included in delivery.

Accessories & Spare Parts

MEGA Nuts	Micro Seal Nuts	Micro Collets	MEGA Wrenches	Taper Cleaners	Collet Protective Cases
					
▶ 326	▶ 326	▶ 324	▶ 351	▶ 370	▶ 326

MEGA Micro Chuck Type S

Micro diameter design is ideal for high speed applications in tight areas.

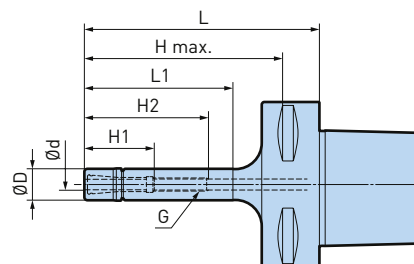
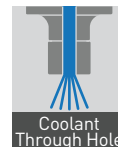

A.4

ø0.45 - 6.05mm

Model	Order No.	Ød	ØD	L	L1	H1	H2	H max.	G	Collet Model
C5-MEGA3S-75	973.207	0,45 - 3,25	10	75	49	22,5	38	68	M4 P0.7	NBC3S
C5-MEGA4S-75	973.208	0.45 - 4.05	12	75	50	26.5	47	68	M5 P0.8	NBC4S
C5-MEGA6S-75	973.209	0.45 - 6.05	14	75	50	28.5	49	68	M7 P0.75	NBC6S
C6-MEGA3S-90	973.210	0.45 - 3.25	10	90	50	22.5	38	81	M4 P0.7	NBC3S
C6-MEGA4S-90	973.211	0.45 - 4.05	12	90	58	26.5	47	81	M5 P0.8	NBC4S
C6-MEGA6S-90	973.212	0.45 - 6.05	14	90	58	28.5	49	81	M7 P0.75	NBC6S

1. MEGA nut is included in delivery.

Accessories & Spare Parts

<p>MEGA Nuts</p> <p>▶ 326</p>	<p>Micro Seal Nuts</p> <p>▶ 326</p>	<p>Micro Collets</p> <p>▶ 324</p>	<p>MEGA Wrenches</p> <p>▶ 351</p>	<p>Taper Cleaners</p> <p>▶ 370</p>	<p>Collet Protective Cases</p> <p>▶ 326</p>
--------------------------------------	--	--	--	---	--

MEGA New Baby Chuck

Ideal ultra precision collet holders for high speed machining. Wide range of lengths and a variety of collet series covers all machining applications.

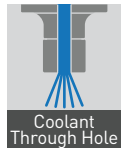

A.4

ø0.25 - 20mm

Model	Order No.	Ød	ØD	L	L1	H	H max.	Collet Model
C3-MEGA6N-45 *	806.312	0.25 - 6	20	45	28	23	23	NBC6
C3-MEGA8N-45 *	807.669	0.5 - 8	25	45	28	26	26	NBC8
C3-MEGA10N-50 *	806.313	1.5 - 10	30	50	34	38	38	NBC10
C3-MEGA13N-50 *	807.671	2.5 - 13	35	50	35	44	44	NBC13
C3-MEGA16N-55 *	806.463	2.5 - 16	42	55	-	49	49	NBC16
C4-MEGA6N-75	978.196	0.25 - 6	20	75	48	23 - 43	69	NBC6
C4-MEGA8N-75	978.201	0.5 - 8	25	75	49	26 - 45	69	NBC8
C4-MEGA10N-50 *	978.334	1.5 - 10	30	50	28	44	44	NBC10
C4-MEGA10N-75	978.202	1.5 - 10	30	75	52	38 - 48	69	NBC10
C4-MEGA13N-50 *	978.335	2.5 - 13	35	50	29	44	44	NBC13
C4-MEGA13N-75 *	978.197	2.5 - 13	35	75	54	64	64	NBC13
C4-MEGA16N-55 *	978.203	2.5 - 16	42	55	-	48	48	NBC16
C4-MEGA20N-60 *	978.204	2.5 - 20	46	60	-	53	53	NBC20
C5-MEGA6N-60	973.213	0.25 - 6	20	60	34	23 - 36	53	NBC6-
C5-MEGA6N-75	973.214	0.25 - 6	20	75	49	23 - 43	68	NBC6-
C5-MEGA6N-90	973.215	0.25 - 6	20	90	62	23 - 43	83	NBC6-
C5-MEGA6N-105	973.216	0,25 - 6	20	105	77	23 - 43	98	NBC6
C5-MEGA6N-120	973.217	0,25 - 6	20	120	90	23 - 43	113	NBC6
C5-MEGA8N-60	973.218	0.5 - 8	25	60	33	26 - 36	53	NBC8
C5-MEGA8N-75	973.219	0.5 - 8	25	75	49	26 - 45	68	NBC8
C5-MEGA8N-90	973.220	• 0.5 - 8	25	90	64	26 - 45	83	NBC8
C5-MEGA8N-105	973.221	0,5 - 8	25	105	77	26 - 45	98	NBC8
C5-MEGA8N-120	973.222	0,5 - 8	25	120	92	26 - 45	113	NBC8
C5-MEGA10N-55 *	973.223	1.5 - 10	30	55	31	48	48	NBC10
C5-MEGA10N-75	973.224	1.5 - 10	30	75	49	38 - 48	68	NBC10
C5-MEGA10N-90	973.225	• 1.5 - 10	30	90	64	38 - 48	83	NBC10
C5-MEGA10N-105	973.226	1,5 - 10	30	105	79	38 - 48	98	NBC10
C5-MEGA10N-120	973.227	1,5 - 10	30	120	92	38 - 48	113	NBC10
C5-MEGA13N-55 *	973.229	2.5 - 13	35	55	31	48	48	NBC13
C5-MEGA13N-75	973.230	2.5 - 13	35	75	49	44 - 48	68	NBC13
C5-MEGA13N-90	973.231	2.5 - 13	35	90	64	44 - 63	83	NBC13
C5-MEGA13N-105	973.232	2,5 - 13	35	105	79	44 - 63	98	NBC13
C5-MEGA13N-120	973.233	2,5 - 13	35	120	94	44 - 63	113	NBC13
C5-MEGA16N-60 *	973.235	2.5 - 16	42	60	38	53	53	NBC16
C5-MEGA16N-75 *	973.236	2.5 - 16	42	75	53	68 - 68	68	NBC16
C5-MEGA16N-90	973.237	2.5 - 16	42	90	69	48 - 63	83	NBC16
C5-MEGA16N-105	973.238	2,5 - 16	42	105	84	48 - 68	98	NBC16
C5-MEGA16N-120	973.239	2,5 - 16	42	120	99	48 - 68	111	NBC16
C5-MEGA20N-60 *	973.241	2.5 - 20	46	60	39	51	51	NBC20
C5-MEGA20N-75 *	973.242	2.5 - 20	46	75	54	66	66	NBC20
C5-MEGA20N-90	973.243	2.5 - 20	46	90	69	51 - 60	83	NBC20
C5-MEGA20N-105	973.244	2,5 - 20	46	105	84	51 - 68	98	NBC20
C5-MEGA20N-120	973.245	2,5 - 20	46	120	99	51 - 68	111	NBC20

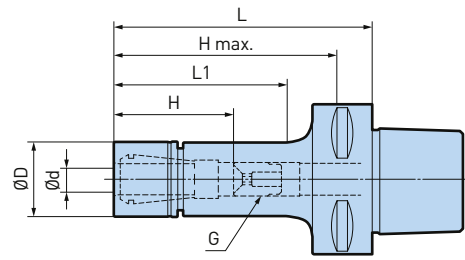

Model	Order No.	Ød	ØD	L	L1	H	H max.	Collet Model
C6-MEGA6N-60	973.247	0.25 - 6	20	60	30	23 - 33	51	NBC6
C6-MEGA6N-75	973.248	0.25 - 6	20	75	43	23 - 43	66	NBC6
C6-MEGA6N-90	973.249	0.25 - 6	20	90	58	23 - 43	81	NBC6
C6-MEGA6N-105	973.250	0.25 - 6	20	105	73	23 - 43	96	NBC6
C6-MEGA6N-120	973.251	0.25 - 6	20	120	88	23 - 43	111	NBC6
C6-MEGA6N-135	973.252	0.25 - 6	20	135	103	23 - 43	126	NBC6
C6-MEGA6N-165	973.253	0.25 - 6	20	165	128	23 - 43	156	NBC6
C6-MEGA6N-200	800.858	0.25 - 6	20	200	163	23 - 43	191	NBC6
C6-MEGA8N-60	973.254	0.5 - 8	25	60	29	26 - 31	51	NBC8
C6-MEGA8N-75	973.255	0.5 - 8	25	75	43	26 - 45	66	NBC8
C6-MEGA8N-90	973.256	0.5 - 8	25	90	58	26 - 45	81	NBC8
C6-MEGA8N-105	973.257	0.5 - 8	25	105	73	26 - 45	96	NBC8
C6-MEGA8N-120	973.258	0.5 - 8	25	120	88	26 - 45	111	NBC8
C6-MEGA8N-135	973.259	0.5 - 8	25	135	103	26 - 45	126	NBC8
C6-MEGA8N-165	973.260	0.5 - 8	25	165	133	26 - 45	156	NBC8
C6-MEGA8N-200	800.860	0.5 - 8	25	200	163	26 - 45	191	NBC8
C6-MEGA10N-60 *	973.261	1.5 - 10	30	60	32	51 - 51	51	NBC10
C6-MEGA10N-75	973.262	1.5 - 10	30	75	43	38 - 45	66	NBC10
C6-MEGA10N-90	973.263	1.5 - 10	30	90	58	38 - 48	81	NBC10
C6-MEGA10N-105	973.264	1.5 - 10	30	105	73	38 - 48	96	NBC10
C6-MEGA10N-120	973.265	1.5 - 10	30	120	88	38 - 48	111	NBC10
C6-MEGA10N-135	973.266	1.5 - 10	30	135	103	38 - 48	126	NBC10
C6-MEGA10N-165	973.267	1.5 - 10	30	165	133	38 - 48	156	NBC10
C6-MEGA10N-200	973.268	1.5 - 10	30	200	168	38 - 48	191	NBC10
C6-MEGA13N-60 *	973.269	2.5 - 13	35	60	32	51 - 51	51	NBC13
C6-MEGA13N-75 *	973.270	2.5 - 13	35	75	45	66 - 66	66	NBC13
C6-MEGA13N-90	973.271	2.5 - 13	35	90	60	44 - 55	81	NBC13
C6-MEGA13N-105	973.272	2.5 - 13	35	105	73	44 - 63	96	NBC13
C6-MEGA13N-120	973.273	2.5 - 13	35	120	90	44 - 63	111	NBC13
C6-MEGA13N-135	973.274	2.5 - 13	35	135	103	44 - 63	126	NBC13
C6-MEGA13N-165	973.275	2.5 - 13	35	165	133	44 - 63	156	NBC13
C6-MEGA13N-200	973.276	2.5 - 13	35	200	168	44 - 63	191	NBC13
C6-MEGA16N-65 *	973.277	2.5 - 16	42	65	37	56 - 56	56	NBC16
C6-MEGA16N-75 *	973.278	2.5 - 16	42	75	47	66 - 66	66	NBC16
C6-MEGA16N-90	973.279	2.5 - 16	42	90	60	48 - 57	81	NBC16
C6-MEGA16N-105	973.280	2.5 - 16	42	105	75	48 - 68	96	NBC16
C6-MEGA16N-120	973.281	2.5 - 16	42	120	90	48 - 68	111	NBC16
C6-MEGA16N-135	973.282	2.5 - 16	42	135	105	48 - 68	126	NBC16
C6-MEGA16N-165	973.283	2.5 - 16	42	165	135	48 - 68	156	NBC16
C6-MEGA16N-200	973.284	2.5 - 16	42	200	170	48 - 68	191	NBC16
C6-MEGA20N-65 *	973.285	2.5 - 20	46	65	37	51 - 51	51	NBC20
C6-MEGA20N-75 *	973.286	2.5 - 20	46	75	47	65 - 65	65	NBC20
C6-MEGA20N-90	973.287	2.5 - 20	46	90	62	51 - 56	76	NBC20
C6-MEGA20N-105	973.288	2.5 - 20	46	105	77	51 - 68	91	NBC20
C6-MEGA20N-120	973.289	2.5 - 20	46	120	92	51 - 68	104	NBC20
C6-MEGA20N-135	973.290	2.5 - 20	46	135	107	51 - 68	111	NBC20
C6-MEGA20N-165	973.291	2.5 - 20	46	165	137	51 - 68	111	NBC20
C6-MEGA20N-200	973.292	2.5 - 20	46	200	172	51 - 68	111	NBC20

continues on the next page

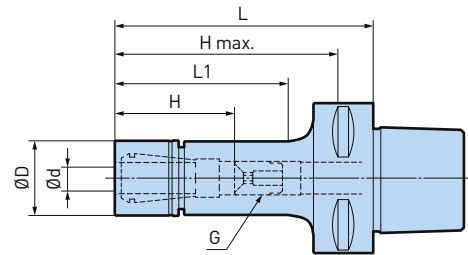

A.4

Model	Order No.	Ød	ØD	L	L1	H	H max.	Collet Model
C8-MEGA6N-90	973.293	0.25 - 6	20	90	45	23 - 43	90	NBC6
C8-MEGA6N-120	973.295	0.25 - 6	20	120	75	23 - 43	120	NBC6
C8-MEGA6N-165	973.297	0.25 - 6	20	165	120	23 - 43	165	NBC6
C8-MEGA8N-90	973.298	0.5 - 8	25	90	46	26 - 45	90	NBC8
C8-MEGA8N-120	973.300	0.5 - 8	25	120	75	26 - 45	120	NBC8
C8-MEGA8N-165	973.302	0.5 - 8	25	165	120	26 - 45	165	NBC8
C8-MEGA10N-90	973.304	1.5 - 10	30	90	45	38 - 48	90	NBC10
C8-MEGA10N-120	973.306	1.5 - 10	30	120	75	38 - 48	120	NBC10
C8-MEGA10N-165	973.308	1.5 - 10	30	165	120	38 - 48	165	NBC10
C8-MEGA13N-90	973.311	2.5 - 13	35	90	50	44 - 63	90	NBC13
C8-MEGA13N-120	973.313	2.5 - 13	35	120	80	44 - 63	120	NBC13
C8-MEGA13N-165	973.315	2.5 - 13	35	165	120	44 - 63	165	NBC13
C8-MEGA13N-200	973.316	2.5 - 13	35	200	155	44 - 63	200	NBC13
C8-MEGA16N-90	973.318	2.5 - 16	42	90	50	48 - 66	90	NBC16
C8-MEGA16N-120	973.320	2.5 - 16	42	120	80	48 - 68	120	NBC16
C8-MEGA16N-165	973.322	2.5 - 16	42	165	125	48 - 68	165	NBC16
C8-MEGA20N-90	973.325	2.5 - 20	46	90	50	51 - 68	83	NBC20
C8-MEGA20N-120	973.327	2.5 - 20	46	120	80	51 - 68	113	NBC20
C8-MEGA20N-165	973.329	2.5 - 20	46	165	125	51 - 68	113	NBC20
C8-MEGA20N-200	973.330	2.5 - 20	46	200	160	51 - 68	113	NBC20

1. MEGA nut is included in delivery.
2. * Adjusting screw cannot be used.
3. "G" is the adjusting screw (optional).
4. "H" is the max. tool shank length that can be inserted for these models.

Accessories & Spare Parts

<p>MEGA Nuts</p>  <p>► 334</p>	<p>MEGA Perfect Seals</p>  <p>► 336</p>	<p>New Baby Collets</p>  <p>► 327</p>	<p>MEGA Wrenches</p>  <p>► 351</p>	<p>Adjusting Screws NBA</p>  <p>► 335</p>	<p>Taper Cleaners</p>  <p>► 370</p>
--	---	---	--	---	---

MEGA E Chuck

Collet chuck designed exclusively for endmilling with high concentricity and rigidity.

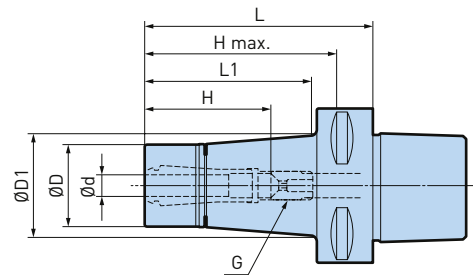

ø3 - 12mm

A.4

Model	Order No.	Ød	ØD	ØD1	L	L1	H	H max.	Collet Model
C4-MEGA6E-50 *	800.683	3 - 6	25	26	50	25	44	44	MEC6
C4-MEGA8E-50 *	800.685	3 - 8	30	31	50	28	44	44	MEC8
C4-MEGA10E-55 *	800.676	3 - 10	35	37	55	34	49	49	MEC10
C4-MEGA13E-60 *	800.678	3 - 12	42	-	60	-	50	50	MEC13
C5-MEGA6E-55 *	973.331	3 - 6	25	26.5	55	29	48	48	MEC6
C5-MEGA6E-90	973.333	3 - 6	25	32.5	90	64	37 - 45	83	MEC6
C5-MEGA6E-105	973.334	3 - 6	25	35.5	105	81	37 - 45	98	MEC6
C5-MEGA6E-120	973.335	3 - 6	25	38	120	97	37 - 45	113	MEC6
C5-MEGA8E-55 *	973.336	3 - 8	30	31.5	55	31	48	48	MEC8
C5-MEGA8E-90	973.338	3 - 8	30	37.5	90	67	42 - 51	83	MEC8
C5-MEGA8E-105	973.339	3 - 8	30	40.5	105	82	42 - 51	98	MEC8
C5-MEGA8E-120	973.340	3 - 8	30	43	120	98	42 - 51	113	MEC8
C5-MEGA10E-60 *	973.341	3 - 10	35	37.5	60	37	53	53	MEC10
C5-MEGA10E-90	973.343	3 - 10	35	43	90	69	48 - 50	83	MEC10
C5-MEGA10E-105	973.344	3 - 10	35	45.5	105	84	48 - 58	98	MEC10
C5-MEGA10E-120	973.345	3 - 10	35	45.5	120	99	48 - 58	113	MEC10
C5-MEGA13E-60 *	973.347	3 - 12	42	44.4	60	39	50	50	MEC13
C5-MEGA13E-75 *	973.348	3 - 12	42	44.8	75	54	68	68	MEC13
C5-MEGA13E-90	973.349	3 - 12	42	44.8	90	69	50 - 60	83	MEC13
C5-MEGA13E-105	973.350	3 - 12	42	46	105	84	50 - 60	98	MEC13
C5-MEGA13E-120	973.351	3 - 12	42	46	120	99	50 - 60	113	MEC13
C6-MEGA6E-60 *	973.353	3 - 6	25	28	60	33	51	51	MEC6
C6-MEGA6E-75	973.354	3 - 6	25	29.5	75	48	37 - 45	66	MEC6
C6-MEGA6E-90	973.355	3 - 6	25	32.1	90	63	37 - 45	81	MEC6
C6-MEGA6E-105	973.356	3 - 6	25	34.7	105	78	37 - 45	96	MEC6
C6-MEGA6E-120	973.357	3 - 6	25	37.3	120	93	37 - 45	111	MEC6
C6-MEGA6E-135	973.358	3 - 6	25	40	135	108	37 - 45	126	MEC6
C6-MEGA6E-165	973.359	3 - 6	25	45.5	165	138	37 - 45	156	MEC6
C6-MEGA8E-60 *	973.360	3 - 8	30	33	60	33	51	51	MEC8
C6-MEGA8E-75	973.361	3 - 8	30	34.2	75	48	42 - 46	66	MEC8
C6-MEGA8E-90	973.362	3 - 8	30	36.7	90	63	42 - 51	81	MEC8
C6-MEGA8E-105	973.363	3 - 8	30	39.5	105	78	42 - 51	96	MEC8
C6-MEGA8E-120	973.364	3 - 8	30	42.1	120	93	42 - 51	111	MEC8
C6-MEGA8E-135	973.365	3 - 8	30	45	135	108	42 - 51	126	MEC8
C6-MEGA8E-165	973.366	3 - 8	30	50.5	165	140	42 - 51	156	MEC8
C6-MEGA10E-65 *	973.367	3 - 10	35	38.5	65	38	56	56	MEC10
C6-MEGA10E-75 *	973.368	3 - 10	35	39.1	75	48	66	66	MEC10
C6-MEGA10E-90	973.369	3 - 10	35	41.6	90	63	48 - 58	81	MEC10
C6-MEGA10E-105	973.370	3 - 10	35	44.4	105	78	48 - 58	96	MEC10
C6-MEGA10E-120	973.371	3 - 10	35	47	120	93	48 - 58	111	MEC10
C6-MEGA10E-135	973.372	3 - 10	35	50	135	110	48 - 58	126	MEC10
C6-MEGA10E-165	973.373	3 - 10	35	55.5	165	141	48 - 58	156	MEC10

continues on the next page



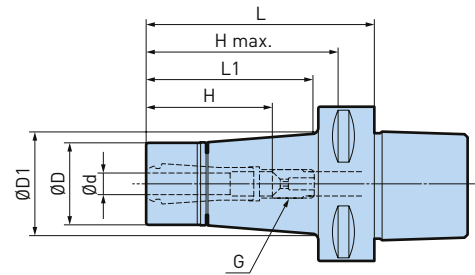







A.4

Model	Order No.	Ød	ØD	ØD1	L	L1	H	H max.	Collet Model
C6-MEGA13E-65 *	973.374	3 - 12	42	45.1	65	39	56	56	MEC13
C6-MEGA13E-75 *	973.375	3 - 12	42	46	75	49	66	66	MEC13
C6-MEGA13E-90	973.376	3 - 12	42	49	90	66	50 - 55	81	MEC13
C6-MEGA13E-105	973.377	3 - 12	42	51.4	105	80	50 - 55	96	MEC13
C6-MEGA13E-120	973.378	3 - 12	42	54.2	120	96	50 - 60	111	MEC13
C6-MEGA13E-135	973.379	3 - 12	42	56.8	135	112	50 - 60	126	MEC13
C6-MEGA13E-165	973.380	3 - 12	42	62.3	165	141	50 - 60	156	MEC13
C8-MEGA6E-90	973.382	3 - 6	25	30.7	90	55	37 - 45	90	MEC6
C8-MEGA6E-135	973.385	3 - 6	25	38.5	135	100	37 - 45	135	MEC6
C8-MEGA8E-90	973.388	3 - 8	30	35.4	90	55	42 - 51	90	MEC8
C8-MEGA8E-135	973.391	3 - 8	30	43.3	135	100	42 - 51	135	MEC8
C8-MEGA10E-90	973.394	3 - 10	35	40.3	90	55	48 - 58	90	MEC10
C8-MEGA10E-120	973.396	3 - 10	35	45.6	120	85	48 - 58	120	MEC10
C8-MEGA10E-135	973.397	3 - 10	35	48.2	135	100	48 - 58	135	MEC10
C8-MEGA13E-90	973.400	3 - 12	42	47	90	55	50 - 60	90	MEC13
C8-MEGA13E-120	973.402	3 - 12	42	52.3	120	85	50 - 60	120	MEC13
C8-MEGA13E-135	973.403	3 - 12	42	54.9	135	100	50 - 60	135	MEC13
C8-MEGA13E-165	973.404	3 - 12	42	60.1	165	130	50 - 60	165	MEC13

- MEGA E nut is included.
- * Adjusting screw cannot be used.
- "G" is the adjusting screw (optional).
- "H" is the max. tool shank length that can be inserted for these models.

Accessories & Spare Parts

<p>MEGA E Nuts</p>  <p>► 340</p>	<p>MEGA E Perfect Seals</p>  <p>► 341</p>	<p>MEGA E Collets</p>  <p>► 340</p>	<p>MEGA Wrenches</p>  <p>► 351</p>	<p>Adjusting Screws NBA</p>  <p>► 335</p>	<p>Taper Cleaners</p>  <p>► 370</p>
---	--	--	---	--	--

MEGA Double Power Chuck Type DS

Close to integral rigidity and precision of a solid tool holder. Flange contacting nut assures highest rigidity. Unique coolant supply design ensures efficient coolant supply to the cutting tool periphery.

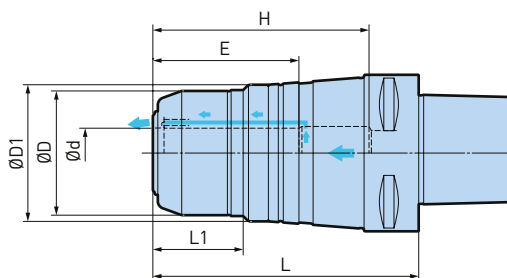

A.4

ø3 - 32mm

Model	Order No.	Ød	ØD	ØD1	L	L1	H	E
C4-MEGA16DS-70	800.680	16	46	47	71	27	65	51
C4-MEGA20DS-65	800.682	20	50	51	66	32	60	52
C5-MEGA16DS-65A	803.141	16	42	52.6	67	27	60	50
C5-MEGA16DS-90A	803.144	16	42	52.6	92	27	73	50
C5-MEGA20DS-75A	803.108	20	50	55	77	36	70	52
C5-MEGA20DS-90A	803.183	20	50	55	92	36	85	52
C5-MEGA25DS-75A ****	803.147	25	62	62.7	77	41	70	58
C5-MEGA25DS-90A	803.179	25	62	62.7	92	41	85	58
C6-MEGA16DS-70A	803.145 •	16	42	52.6	72	27	63	50
C6-MEGA16DS-90A	803.206	16	42	52.6	92	27	83	50
C6-MEGA16DS-105A ***	803.184	16	42	52.6	107	27	73	50
C6-MEGA16DS-135A ***	803.112	16	42	52.6	137	27	73	50
C6-MEGA20DS-75A	803.185 •	20	50	55	77	36	68	52
C6-MEGA20DS-90A	803.125	20	50	55	92	36	83	52
C6-MEGA20DS-105A	803.113	20	50	55	107	36	87	52
C6-MEGA20DS-135A *	803.166	20	50	55	137	36	71 - 81	52
C6-MEGA25DS-75A **	803.114	25	62	62.7	77	41	68	58
C6-MEGA25DS-90A	803.177	25	62	62.7	92	41	83	58
C6-MEGA25DS-105A	803.128	25	62	62.7	107	41	87	58
C6-MEGA25DS-135A *	803.195	25	62	62.7	137	41	73 - 83	58
C6-MEGA32DS-90A	803.129	32	70	70.7	92	35	83	62
C6-MEGA32DS-105A	803.167	32	70	70.7	107	35	92	62
C6-MEGA32DS-135A *	803.121	32	70	70.7	137	35	81 - 91	62

continues on the next page



A.4

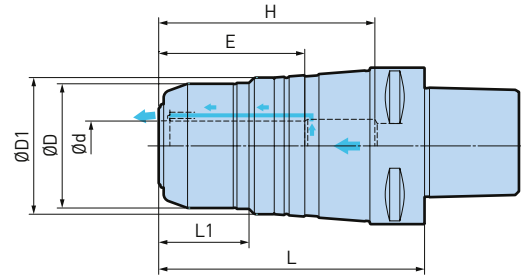

Model	Order No.	Ød	ØD	ØD1	L	L1	H	E
C8-MEGA16DS-70	973.465	16	46	55	72.5	26	73	52
C8-MEGA16DS-105 ***	973.466	16	46	55	107.5	26	73	52
C8-MEGA16DS-135 ***	973.467	16	46	55	137,5	26	73	48
C8-MEGA20DS-75	973.469	20	60	69	77.5	28	77	58
C8-MEGA20DS-135 *	973.471	20	60	69	137,5	28	71 - 81	58
C8-MEGA20DS-165 *	973.472	20	60	69	167,5	28	71 - 81	50
C8-MEGA25DS-75	973.473	25	70	77	77.5	34	77	67
C8-MEGA25DS-135 *	973.475	25	70	77	137,5	34	78 - 88	67
C8-MEGA25DS-165 *	973.476	25	70	77	167,5	34	78 - 89	67
C8-MEGA32DS-90	973.477	32	80	86	92.5	42	92	73
C8-MEGA32DS-105	973.478 •	32	80	86	107.5	42	102	73
C8-MEGA32DS-135	973.479	32	80	86	137,5	42	107	60
C8-MEGA32DS-165 *	973.480	32	80	86	167,5	42	80 - 97	73

- * Adjusting screw can be used
- ** Only C collet (C25-) and OCA are compatible.
- *** Hex socketed head screw (M8) can be used as an adjusting screw.
- **** Adjustable straight collet (C25- +CS) and OCA collet cannot be used.
- MEGA wrench is to be ordered separately.
- "E" is the min. clamping length.
- "H" is the max. tool shank length that can be inserted for these models.

Accessories & Spare Parts

PJC Collets	PSC Collets	C Collets	MEGA Wrenches
			
▶ 347	▶ 348	▶ 349	▶ 351

New Hi-Power Milling Chuck

The original design of slit structure assures heavy and finish end milling with high power and precision.

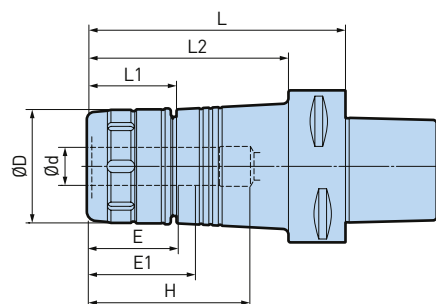

ø3 - 32mm

A.4

Model	Order No.	Ød	ØD	L	L1	L2	H	E	E1
C5-HMC16S-65	800.734	16	43	65	44	45	58	48	55
C5-HMC20S-75	800.736	20	50	75	44	-	68	50	56
C5-HMC20S-105	800.735	20	50	105	44	-	85	50	56
C5-HMC25S-75 **	803.042	25	55	75	47	-	68	56	57
C5-HMC25S-105	803.041	25	55	105	47	-	87	56	57
C5-HMC32S-85 ***	803.043	32	62	85	56	-	78	60	58
C6-HMC16S-70	800.842	16	43	70	44	48	61	48	55
C6-HMC20S-75	800.845	20	50	75	44	53	66	50	56
C6-HMC20S-105	800.843	20	50	105	44	83	85	50	56
C6-HMC20S-120 *	800.844	20	50	120	44	98	69 - 79	50	56
C6-HMC25S-75 ****	800.848	25	59	75	45	53	66	56	57
C6-HMC25S-105	800.846	25	59	105	45	81	87	56	57
C6-HMC25S-135 *	800.847	25	59	135	45	133	73 - 83	56	57
C6-HMC32S-90	800.851	32	68	90	54	-	81	60	64
C6-HMC32S-105	800.849	32	68	105	54	-	90	60	64
C6-HMC32S-135 *	800.850	32	68	135	54	-	79 - 89	60	64
C8-HMC20-80	973.680	20	60	80	46	50	80	50	56
C8-HMC20-135 *	973.682	20	60	135	46	105	69 - 79	50	56
C8-HMC25-85	973.684	25	62	85	55	-	85	56	65
C8-HMC25-135 *	973.686	25	62	135	55	105	76 - 86	56	65
C8-HMC32-95	973.688	32	80	95	63	-	95	60	71
C8-HMC32-135	973.690	32	80	135	63	-	105	60	71

- * Adjusting screw can be used
- ** Only C collet (C25-) and OCA are compatible.
- *** Adjustable straight collet (C25-+CS) cannot be used.
- **** Only C collet (C25-) can be used.
- Wrench is to be ordered separately.
- "E" is the min. clamping length.
- "E1" is the min. clamping length for optimum use with center through coolant.
- "H" is the max. tool shank length that can be inserted for these models.

Accessories & Spare Parts

PJC Collets	OCA Collets	PSC Collets	C Collets	FK Wrenches	Adjusting Screws HMA
					
▶ 347	▶ 348	▶ 348	▶ 349	▶ 352	▶ 350

Hydraulic Chuck Jet Through

Hydraulic chuck provides efficient coolant supply through the cutting tool or periphery of the cutting tool.

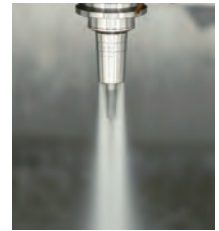

A.4

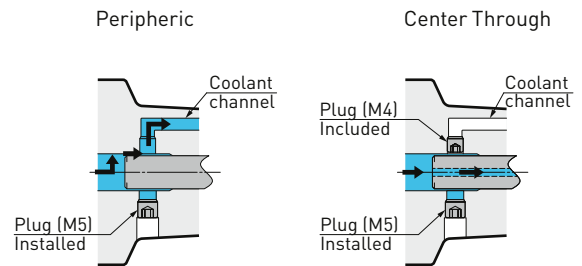
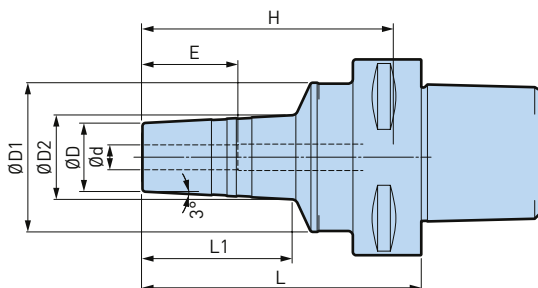

ø4 - 12mm

Model	Order No.	Ød	ØD	ØD1	ØD2	L	L1	H	E
C5-HDC4J-90	807.434	4	20	42	26	90	51	83	19
C5-HDC6J-90	807.435	6	20	42	26	90	51	83	25
C5-HDC8J-90	807.436	8	22	42	28	90	52	83	31
C5-HDC10J-90	807.437	10	24	44	30	90	52	83	33
C5-HDC12J-90	807.438	12	26	46	32	90	52	83	36
C6-HDC4J-90	807.439	4	20	48	26	90	47	81	19
C6-HDC6J-90	807.440	6	20	48	26	90	47	81	25
C6-HDC6J-120	807.441	6	20	48	28	120	74	111	25
C6-HDC8J-90	807.442	8	22	48	28	90	48	81	31
C6-HDC8J-120	807.443	8	22	48	30	120	75	111	31
C6-HDC10J-90	807.444	10	24	48	30	90	48	81	33
C6-HDC10J-120	807.445	10	24	48	32	120	75	111	33
C6-HDC12J-90	807.446	12	26	48	32	90	49	81	36
C6-HDC12J-120	807.447	12	26	48	34	120	76	111	36

1. "E" is the min. clamping length.
2. "H" is the max. tool shank length that can be inserted for these models.

Caution

- Use only cutting tools that have a shank tolerance within h6.
- Roughing endmills are not recommended for use with hydraulic chucks.
- Do not use with cutting tools made with a flat on the shank. (ie: Weldon type shank)
- Do not tighten the clamping screw without first inserting a cutting tool into the hydraulic chuck.
- Always insert the cutting tool into the hydraulic chuck beyond min. clamping length E.

Accessories & Spare Parts



Hydraulic Chuck Standard

For high precision machining in automotive, aerospace, medical and die & mold.

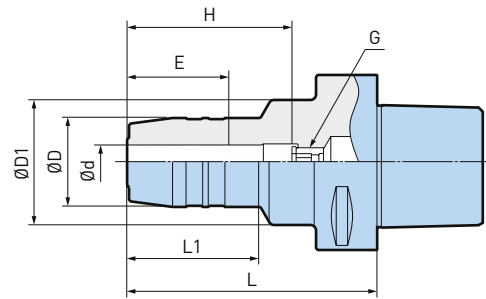
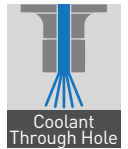

ø3 - 32mm

A.4

Model	Order No.	Ød	ØD	ØD1	L	L1	H	E	G
C5-HDC14-90	800.712	14	34	45	90	48	53 - 60	38	HDA12-10010
C5-HDC16-75 *	800.716	16	38	50	75	35	68	43	-
C5-HDC16-90 *	800.717	16	38	48	90	48	83	43	-
C5-HDC18-90 *	800.719	18	40	48	90	48	83	43	-
C5-HDC20-75 *	800.721	20	42	52	75	35	68	43	-
C5-HDC20-90 *	800.722	20	42	50	90	48	83	43	-
C5-HDC25-90 *	800.723	25	55	63	90	48	83	52	-
C6-HDC14-90	800.808	14	34	45	90	48	48 - 60	38	HDA10-08015
C6-HDC14-120	800.806	14	34	45	120	48	38 - 60	38	HDA10-08032
C6-HDC16-75 *	800.814	16	38	50	75	35	66	43	-
C6-HDC16-90 *	800.815	16	38	47	90	48	81	43	-
C6-HDC16-120	800.812	16	38	48	120	48	43 - 70	43	HDA16-12037
C6-HDC18-90 *	800.818	18	40	48	90	48	66	43	-
C6-HDC18-120	800.816	18	40	49	120	48	43 - 70	43	HDA16-12037
C6-HDC20-75 *	800.821	20	42	53	75	33	66	43	-
C6-HDC20-90 *	800.822	20	42	50	90	48	72	43	-
C6-HDC20-120	800.819	20	42	50	120	48	43 - 70	43	HDA16-12037
C6-HDC25-90 *	800.825	25	55	63	90	46	80	52	-
C6-HDC25-120	800.823	25	55	63	120	51	67 - 79	52	HDA20-16015
C6-HDC32-90 *	800.827	32	75	63	90	43	81	56	-
C6-HDC32-120	800.826	32	63	-	120	-	66 - 78	56	HDA20-16015

- * Adjusting screw cannot be used.
- "E" is the min. clamping length.
- "G" is the adjusting screw (optional).
- "H" is the max. tool shank length that can be inserted for these models.

Caution

- Use only cutting tools that have a shank tolerance within h6.
- Roughing endmills are not recommended for use with hydraulic chucks.
- Do not use with cutting tools made with a flat on the shank. (ie: Weldon type shank)
- Do not tighten the clamping screw without first inserting a cutting tool into the hydraulic chuck.
- Always insert the cutting tool into the hydraulic chuck beyond min. clamping length E.

Accessories & Spare Parts

<p>PJC Collets</p>  <p>▶ 347</p>	<p>PSC Collets</p>  <p>▶ 348</p>	<p>Adjusting Screws HDA</p>  <p>▶ 354</p>	<p>Wiper Cleaners</p>  <p>▶ 370</p>
---	---	--	--

Shrink Chuck Slim

Slim design reduces outer diameter for machining in tight spaces.

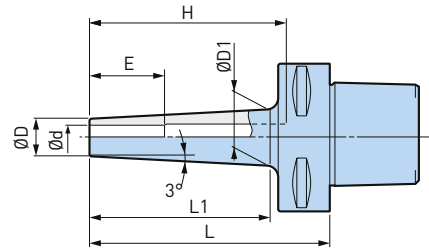

A.4

Model	Order No.	Ød	ØD	ØD1	L	L1	E	H
C6-SRC6S-165	973.710	6	10	24	165	133	26	[143]
C6-SRC8S-120	973.711	8	13	22.5	120	92	26	[98]
C6-SRC8S-165	973.712	8	13	27	165	133	26	[143]
C6-SRC10S-120	973.713	10	16	25.5	120	92	32	62
C6-SRC10S-165	973.714	10	16	30.5	165	135	32	62
C6-SRC12S-120	973.715	12	19	28.5	120	92	36	72
C6-SRC12S-165	973.716	12	19	33	165	135	36	72

1. Use a carbide shank cutter with tolerance h6.
2. Please refer to the operation manual of heating / cooling equipment, as some equipment may not be compatible.

Shrink Chuck Standard

Substantial body provides higher rigidity.

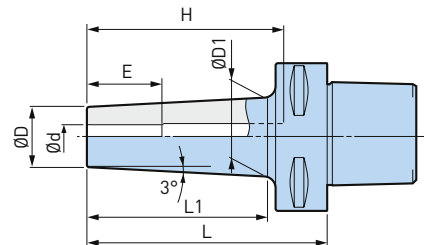

Model	Order No.	Ød	ØD	ØD1	L	L1	E	H
C6-SRC6-90	973.553	6	14	20,5	90	63	26	81
C6-SRC8-90	973.554	8	18	24,5	90	63	26	81
C6-SRC10-90	973.555	10	22	28,5	90	63	32	81
C6-SRC12-90	973.556	12	24	30,5	90	63	36	81
C6-SRC16-90	973.557	16	28	34,5	90	63	38	81
C6-SRC16-165	973.558	16	28	42,5	165	138	38	80
C6-SRC20-90	973.559	20	34	40,5	90	63	42	80
C6-SRC20-165	973.560	20	34	48,5	165	138	42	100

1. Use a carbide shank cutter with tolerance h6.
2. Please refer to the operation manual of heating / cooling equipment, as some equipment may not be compatible.

CKB/CKN Shanks with Center Through Coolant

Basic Holder for rough and finish boring heads of the proven BIG KAISER Boring System.

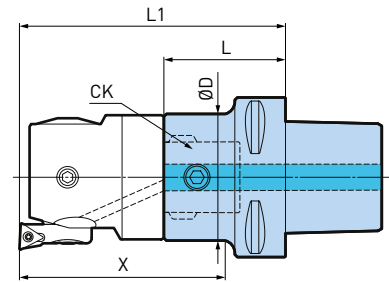
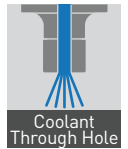

A.4

CK1 - CK7

Model	Order No.	CK	ØD	L	L1	X
C4-CKB1-48	806.698	CKB1	19	47.5	80	55
C4-CKB2-45	806.699	CKB2	24	44.5	80	55
C4-CKB3-40	806.700	CKB3	31	40	80	57
C4-CKB4-33	806.701	CKB4	39	33	80	62
C5-CKB1-73	806.702	CKB1	19	72.5	105	80
C5-CKB2-85	328.273	CKB2	24	84,5	120	96
C5-CKB3-55	328.223	CKB3	31	55	95	70
C5-CKB4-48	328.224	CKB4	39	48	95	70
C5-CKB5-50	328.226	CKB5	50	50	107	-
C5-CKB6-50	328.037	CKB6	64	64	120	-
C5-CKN6-50	328.037N	CKN6	63.5	50	121	-
C6-CKB1-78	328.321	CKB1	19	77,5	110	83
C6-CKB2-90	328.322	CKB2	24	89,5	125	98
C6-CKB3-65	328.036	CKB3	31	65	105	78
C6-CKB4-58	328.035	CKB4	39	58	105	78
C6-CKB4-93	869.019	CKB4	39	93	140	103
C6-CKB5-48	328.034	CKB5	50	48	105	79
C6-CKN6-59	328.033N	CKN6	63.5	59	130	-
C8-CKB4-118	806.703	CKB4	39	118	165	130
C8-CKB4-178	806.704	CKB4	39	178	225	190
C8-CKB5-108	806.705	CKB5	50	108	165	130
C8-CKB5-183	806.706	CKB5	50	183	240	205
C8-CKN6-74	328.053N	CKN6	63.5	74	145	110
C8-CKB6-169	806.707	CKB6	63.5	169	240	206
C8-CKN7-73	328.032N	CKN7	90	73	190 (160)	-
C8-CKB7-123	806.708	CKB7	90	123	240 (210)	-
C8-CKB7-123	806.708	CKB7	90	123	240 (210)	-

1. X and L1 dimensions on the table are reference figures when EWN/EWE head is mounted.
2. () Indicate the length when short version of EWN (EWN100-203CKB7-87) is mounted.

Accessories & Spare Parts

Fine Boring Heads



► 396-399

Face Mill Arbors Type FMH

For cutters that require a coolant hole through the pilot.

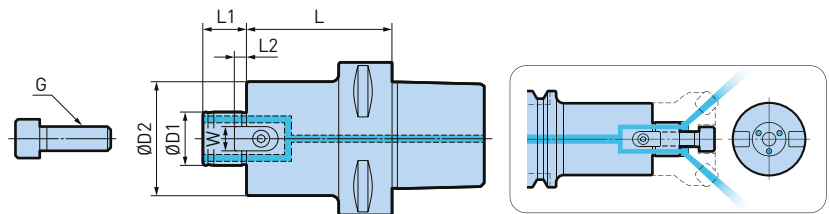

A.4

Model	Order No.	ØD1	ØD2	L	L1	L2	W	G	ØC min.
C5-FMH22-47-60	973.718	22	47	60	18	5	10	M10	36
C5-FMH22-47-90	800.695	22	47	90	18	5	10	M10	36
C5-FMH22-60-60	973.720	22	60	60	18	5	10	M10	38
C5-FMH27-60-60	800.698	27	60	60	20	6	12	M12	46
C6-FMH22-47-45	973.721	22	47	45	18	5	10	M10	38
C6-FMH22-47-60	973.722	22	47	60	18	5	10	M10	36
C6-FMH22-47-90	973.723	22	47	90	18	5	10	M10	36
C6-FMH22-47-150	800.783	22	47	150	18	5	10	M10	36
C6-FMH22-60-45	973.724	22	60	45	18	5	10	M10	38
C6-FMH22-60-60	973.725	22	60	60	18	5	10	M10	38
C6-FMH22-60-90	973.726	22	60	90	18	5	10	M10	38
C6-FMH27-60-45	800.788	27	60	45	20	6	12	M12	46
C6-FMH27-60-60	800.789	27	60	60	20	6	12	M12	46
C6-FMH27-60-90	800.790	27	60	90	20	6	12	M12	46
C6-FMH27-60-150	800.787	27	60	150	20	6	12	M12	46
C8-FMH22-47-60	973.727	22	47	60	18	5	10	M10	36
C8-FMH22-47-105	973.728	22	47	105	18	5	10	M10	36
C8-FMH22-47-150	973.729	22	47	150	18	5	10	M10	36
C8-FMH22-47-200	800.899	22	47	200	18	5	10	M10	36
C8-FMH22-60-60	973.730	22	60	60	18	5	10	M10	38
C8-FMH22-60-105	973.731	22	60	105	18	5	10	M10	38
C8-FMH22-60-150	973.732	22	60	150	18	5	10	M10	38
C8-FMH27-60-60	800.906	27	60	60	20	6	12	M12	46
C8-FMH27-60-105	800.903	27	60	105	20	6	12	M12	46
C8-FMH27-60-150	800.904	27	60	150	20	6	12	M12	46
C8-FMH27-60-200	800.905	27	60	200	20	6	12	M12	46
C8-FMH32-96-75	800.912	32	96	75	22	7	14	M16	58
C8-FMH32-96-105	800.910	32	96	105	22	7	14	M16	58
C8-FMH32-96-150	800.911	32	96	150	22	7	14	M16	58

1. By using a clamping screw with a through bore, coolant is supplied through the screw
2. Clamp bolt is included.

Accessories & Spare Parts

Clamp Bolts



► 355

Side Lock Holders for Drills

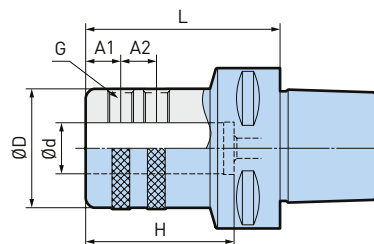
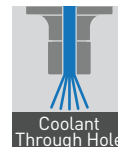

ø16 - 40mm

A.4

Model	Order No.	Ød	ØD	L	A1	A2	H	G
C4-TSL16-56	800.687	16	48	56	14	14	48	M10 P1.25
C4-TSL20-60	800.688	20	48	60	14	14	50	M10 P1.25
C4-TSL25-77	800.689	25	48	77	15	20	56	M16 P1.5
C5-TSL16-60	973.115	16	48	60	14	14	48	M10 P1.25
C5-TSL20-60	973.116	20	48	60	14	14	50	M10 P1.25
C5-TSL25-75	973.117	25	48	75	15	20	56	M16 P1.5
C5-TSL32-85	800.775	32	63	85	15	20	60	M16 P1.5
C6-TSL16-70	973.119	16	48	70	14	14	48	M10 P1.25
C6-TSL20-70	973.120	20	48	70	14	14	50	M10 P1.25
C6-TSL25-70	973.121	25	48	70	15	20	56	M16 P1.5
C6-TSL32-75	973.122	32	63	75	15	20	60	M16 P1.5
C6-TSL40-85	973.123	40	68	85	15	25	70	M16 P1.5
C8-TSL16-80	973.124	16	48	80	14	14	48	M10 P1.25
C8-TSL20-80	973.125	20	48	80	14	14	50	M10 P1.25
C8-TSL25-85	973.126	25	48	85	15	20	56	M16 P1.5
C8-TSL32-90	973.127	32	63	90	15	20	60	M16 P1.5
C8-TSL40-95	973.128	40	68	95	15	25	70	M16 P1.5

1. "H" is the max. tool shank length that can be inserted for these models.
2. Not compatible with Weldon DIN 1835 B / DIN 6535 HB.

Accessories & Spare Parts

Sleeves for TSL & OSL



▶ 355

Side Lock Holders for Weldon

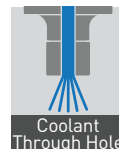

A.4

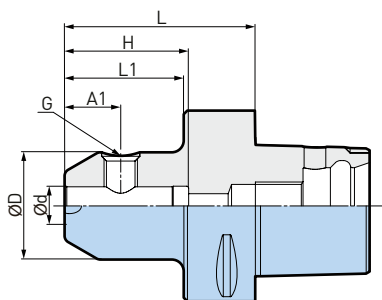

Fig. 1

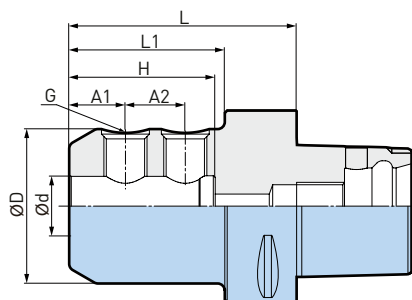

Fig. 2

ø6 - 40mm

Model	Order No.	Fig.	Ød	ØD	L	L1	A1	A2	H	G
C6-ISL16-80	973.562	1	16	48	80	52	24	-	52	M14
C6-ISL20-80	973.563	1	20	52	80	55	25	-	55	M16
C6-ISL25-105	973.564	1	25	65	105	60	24	25	60	M18 P2.0
C6-ISL32-115	973.565	1	32	72	115	90	24	28	90	M20 P2.0
C8-ISL6-80	328.370	1	6	24	80	50	17.5	-	40	M6
C8-ISL8-80	328.371	1	8	26	80	50	17.5	-	40	M8
C8-ISL10-80	328.372	1	10	32	80	50	19.5	-	44	M10
C8-ISL12-80	328.373	1	12	38	80	50	22	-	49	M12
C8-ISL14-80	328.374	1	14	40	80	50	22	-	49	M12
C8-ISL16-80	328.375	1	16	45	80	50	23.5	-	52	M14
C8-ISL18-80	328.376	1	18	47	80	50	23.5	-	52	M14
C8-ISL20-85	328.419	1	20	52	85	55	24.5	-	54	M16
C8-ISL25-95 *	328.420	2	25	64.4	95	65	23.5	25	61	M18 P2
C8-ISL32-95 *	328.421	2	32	71.5	95	65	23.5	28	65	M20 P2
C8-ISL40-105 *	328.422	2	40	80	105	-	29.5	32	75	M20 P2

1. "H" is the max. tool shank length that can be inserted for these models.
2. Use a cutting tool in accordance to DIN 1835 B/DIN 6535 HB.
3. * Peripheral coolant supply is not available.

Side Cutter Arbors

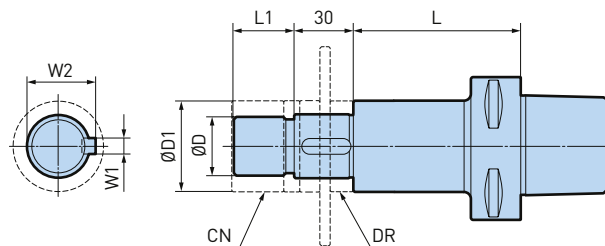

A.4

Model	Order No.	ØD	ØD1	L	L1	W1	W2
C6-SCA25.4-75	800.887	25.4	40	75	25	6.35	27.78
C6-SCA31.75-75	800.888	31.75	46	75	30	7.92	34.92
C8-SCA25.4-90	800.940	25.4	40	90	25	6.35	27.78
C8-SCA31.75-90	800.942	31.75	46	90	30	7.92	34.92

1. Nut (CN) is included.
2. Distance collars (DR) of 5 mm, 8 mm, 10 mm and 12 mm are included.

Morse Taper Holders

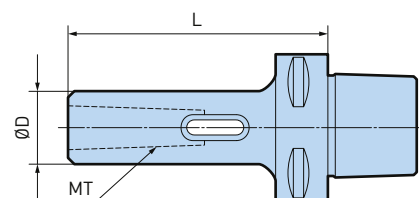

Model	Order No.	MT No.	ØD	L
C5-MTA1-95	973.572	1	25	95
C5-MTA2-110	973.573	2	32	110
C5-MTA3-130	973.574	3	40	130
C6-MTA1-95	973.575	1	25	95
C6-MTA2-110	973.576	2	32	110
C6-MTA3-130	973.577	3	40	130
C8-MTA1-105	973.578	1	25	105
C8-MTA2-120	973.579	2	32	120
C8-MTA3-140	973.580	3	40	140

MEGA Synchro Tapping Holder

Compensates for synchronization errors during rigid tapping. Improves thread quality and tool life by reducing thrust loads caused by synchronization errors up to 90%.

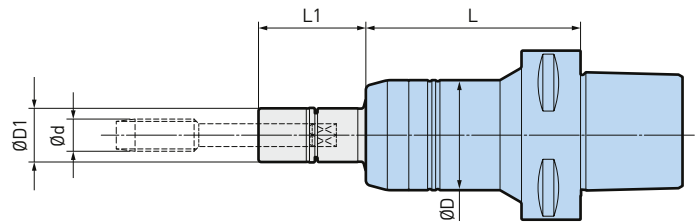

A.4

M3 - M20

Model	Order No.	Tap Holder	Ød	ØD	ØD1	L	L1
C5-MGT6-75	800.767	MGT6	M3-M8	36	16	75	30 - 200
C5-MGT12-75	800.765	MGT12	M5-M12 / P1/8	41	20	75	30 - 200
C5-MGT20-100	800.766	MGT20	M10-M20 / P1/4-P1/2	54	30	100	35 - 150
C6-MGT6-80	973.754	MGT6	M3-M8	36	16	80	30 - 200
C6-MGT12-80	973.755	MGT12	M5-M12 / P1/8	41	20	80	30 - 200
C6-MGT20-100	973.756	MGT20	M10-M20 / P1/4-P1/2	54	30	100	35 - 150
C8-MGT6-80	800.935	MGT6	M3-M8	36	16	80	30 - 200
C8-MGT12-80	800.933	MGT12	M5-M12 / P1/8	41	20	80	30 - 200
C8-MGT20-95	800.934	MGT20	M10-M20 / P1/4-P1/2	54	30	95	35 - 150

1. Tap holder and wrench are to be ordered separately.
2. Synchronized tapping function is required on the machine.

Accessories & Spare Parts

Tap Holder	MEGA Wrenches	Accessories
<p>▶ 356-363</p>	<p>▶ 351</p>	<p>▶ 364-365</p>

Extensions

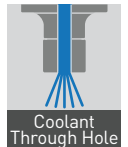
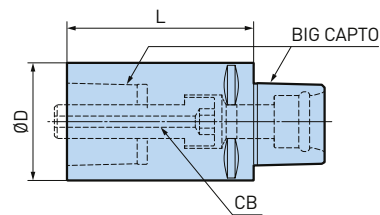

Model	Order No.	BIG CAPTO	ØD	L
C6-C6-100	803.738	C6	63	100
C8-C8-100	803.740	C8	80	100

1. Hexagon socket head cap screw (CB) is included. M20xP2 / Tightening Torque 170 Nm

Reductions

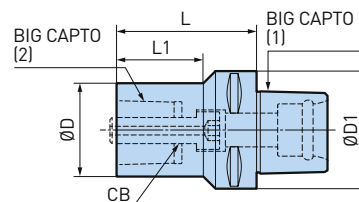

Model	Order No.	BIG CAPTO	ØD	ØD1	L	L1
C6-C5-75	803.737	C6 (1) - C5 (2)	50	63	75	46
C8-C6-85	803.739	C8 (1) - C6 (2)	63	80	85	50

1. Hexagon socket head cap screw (CB) is included.
 C6-C5: M16xP1.5 / Tightening Torque 95 Nm
 C8-C6: M20xP2 / Tightening Torque 170 Nm

BIG CAPTO Basic Holders

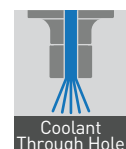
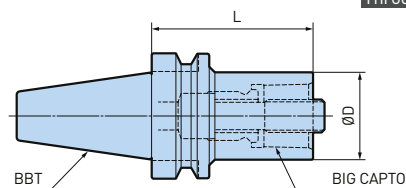

Model	Order No.	BIG CAPTO	ØD	L
BBT40-C3-30	973.598	C3	32	30
BBT40-C4-40	802.350	C4	40	40
BBT40-C5-50	973.600	C5	50	50
BBT40-C6-75	973.601	C6	63	75
BBT50-C3-40	973.602	C3	32	40
BBT50-C4-40	973.603	C4	40	40
BBT50-C5-40	973.604	C5	50	40
BBT50-C6-50	973.605	C6	63	50
BBT50-C8-70	803.736	C8	80	70

1. BIG-PLUS® tools can be used in machining centers with non BIG-PLUS® spindles.
 2. Clamp bolt is included.

Tool Holders and Components CK

CKB/CKN Reductions	252
CKB/CKN Extensions / Smart Damper Extensions	253
CKN Components	254
End Mill Holders / Milling Cutter Arbors	256
ER Collet Chucks / ER Collet Adapters	259
Tapping Holders	260
Blanks	261
DIN 2080 / Morse Taper Shanks	262

CKB/CKN Reductions

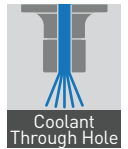
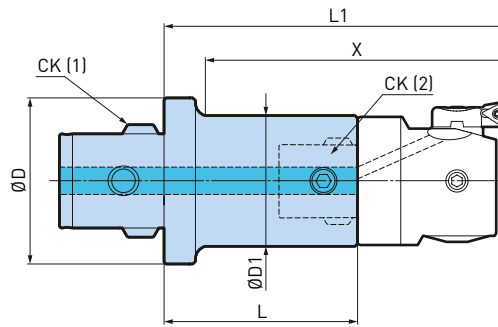



A.5

Model	Order No.	CK (1)	CK (2)	ØD	ØD1	L	L1	X
CKB2-CKB1-36	332.210	CKB2	CKB1	24	19	36	68.5	55
CKB3-CKB1-41	332.310	CKB3	CKB1	31	19	40.5	73	60
CKB3-CKB2-35	332.320	CKB3	CKB2	31	24	34.5	70	60
CK4-CKB1-58	332.410	CK4	CKB1	39	19	57.5	90	75
CKB4-CKB2-52	332.420	CKB4	CKB2	39	24	51.5	87	75
CKB4-CKB3-47	332.430	CKB4	CKB3	39	31	47	87	75
CK5-CKB1-58	332.511	CK5	CKB1	50	19	57.5	90	70
CK5-CKB1-88	332.510	CK5	CKB1	50	19	87.5	120	100
CK5-CKB2-52	332.521	CK5	CKB2	50	24	51.5	87	70
CK5-CKB2-82	332.520	CK5	CKB2	50	24	81.5	117	100
CKB5-CKB3-47	332.531	CKB5	CKB3	50	31	47	87	70
CKB5-CKB3-77	332.530	CKB5	CKB3	50	31	77	117	100
CKB5-CKB4-40	332.541	CKB5	CKB4	50	39	40	87	70
CKB5-CKB4-70	332.545	CKB5	CKB4	50	39	70	117	100
CK6-CKB1-67	332.611	CK6	CKB1	63.5	19	66.5	99	65
CK6-CKB1-102	332.610	CK6	CKB1	63.5	19	101.5	134	100
CK6-CKB2-61	332.621	CK6	CKB2	63.5	24	60.5	96	80
CK6-CKB2-96	332.620	CK6	CKB2	63.5	24	95.5	131	115
CK6-CKB3-56	332.631	CK6	CKB3	63.5	31	56	96	80
CK6-CKB3-91	332.630	CK6	CKB3	63.5	31	91	131	115
CK6-CKB3-136	332.632	CK6	CKB3	63.5	31	136	176	160
CKB6-CKB4-49	332.641	CKB6	CKB4	63.5	39	49	96	80
CKB6-CKB4-84	332.645	CKB6	CKB4	63.5	39	84	131	115
CKB6-CKB4-129	332.642	CKB6	CKB4	63.5	39	129	176	160
CKB6-CKB5-39	332.651	CKB6	CKB5	63.5	50	39	96	80
CKB6-CKB5-74	332.655	CKB6	CKB5	63.5	50	74	131	115
CKB6-CKB5-119	332.652	CKB6	CKB5	63.5	50	119	176	160
CKB7-CKB4-70	332.741	CKB7	CKB4	90	39	70	117	100
CKB7-CKB4-100	332.745	CKB7	CKB4	90	39	100	147	130
CKB7-CKB5-60	332.751	CKB7	CKB5	90	50	60	117	100
CKB7-CKB5-90	332.755	CKB7	CKB5	90	50	90	147	130
CKB7-CKB5-120	332.750	CKB7	CKB5	90	50	120	177	160
CKB7-CKB6-76	332.765	CKB7	CKB6	90	63.5	76	147	130
CKN7-CKN6-76	332.765N	CKN7	CKN6	90	63.5	76	147	160
CKB7-CKB6-106	332.766	CKB7	CKB6	90	63.5	106	177	160

1. X and L1 dimensions on the table are reference figures when EWN/EWE head is mounted.

Accessories & Spare Parts

Fine Boring Heads	Clamping Screws CK	Cross bolts
		
▶ 396-399	▶ 498	▶ 498

CKB/CKN Extensions

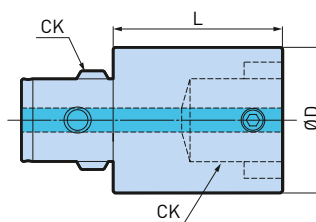

Model	Order No.	CK	ØD	L
CKB1-CKB1-20	331.110	CKB1	19	20
CKB1-CKB1-30	331.111	CKB1	19	30
CKB2-CKB2-30	331.220	CKB2	24	30
CKB2-CKB2-45	331.221	CKB2	24	45
CKB3-CKB3-30	331.330	CKB3	31	30
CKB3-CKB3-45	331.331	CKB3	31	45
CKB4-CKB4-40	331.440	CKB4	39	40
CKB4-CKB4-60	331.445	CKB4	39	60
CKB5-CKB5-60	331.550	CKB5	50	60
CKB5-CKB5-90	331.555	CKB5	50	90
CKB6-CKB6-60	331.660	CKB6	63.5	60
CKN6-CKN6-60 *	331.660N	CKN6	63.5	60
CKB6-CKB6-100	331.665	CKB6	63.5	100
CKN6-CKN6-100 *	331.665N	CKN6	63.5	100
CKB7-CKB7-100	331.775	CKB7	90	100
CKN7-CKN7-100 *	331.775N	CKN7	90	100
CKB7-CKB7-160	331.776	CKB7	90	160
CKN7-CKN7-160 *	331.776N	CKN7	90	160

1. * Two pieces of CK-screws are included.

Smart Damper Extensions

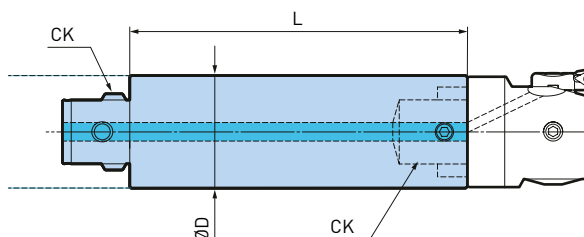

Extension with integrated damping system for highly efficient deep hole finish boring.



Model	Order No.	CK	ØD	L
CKB44DP-120	389.365	CKB4	39	120
CKB55DP-150	389.366	CKB5	50	150
CKB66DP-180	389.367	CKB6	64	180

1. Please do not use other extensions as they may cause chattering.

Accessories & Spare Parts

Fine Boring Heads	Clamping Screws CK	Cross bolts
		
▶ 396-399	▶ 498	▶ 498

CKN Reductions and Extensions System

CKN7 - CKB6 Reductions Aluminium

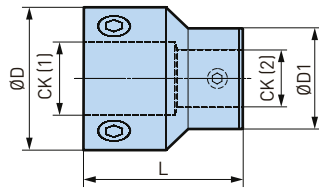

Model	Order No.	CK (1)	CK (2)	ØD	ØD1	L
CKN7-CKB6-100	332.870N	CKN7	CKB6	90	63.5	100

CKN Extensions Aluminium

A.5

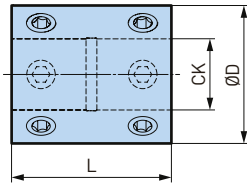

Model	Order No.	CK	ØD	L
T-CKN6-CKN6-80	331.867N	CKN6	63.5	80
T-CKN6-CKN6-120	331.868N	CKN6	63.5	120
T-CKN7-CKN7-100	331.877N	CKN7	90	100
T-CKN7-CKN7-150	331.879N	CKN7	90	150
T-CKN7-CKN7-200	331.878N	CKN7	90	200

CKN - CKB Extensions Aluminium

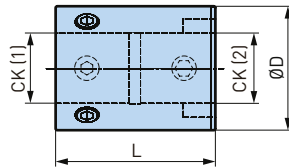

Model	Order No.	CK (1)	CK (2)	ØD	L
T-CKN6-CKB6-80	331.860N	CKN6	CKB6	63.5	80
T-CKN6-CKB6-120	331.861N	CKN6	CKB6	63.5	120
T-CKN7-CKB7-100	331.870N	CKN7	CKB7	90	100
T-CKN7-CKB7-150	331.871N	CKN7	CKB7	90	150

CKN Double Connector Couplings

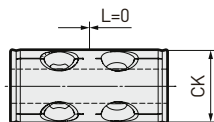

Model	Order No.	CK	ØD
DC-CKN6-CKN6-0	331.864N	CKN6	63.5
DC-CKN7-CKN7-0	331.874N	CKN7	90

CKN Double Connector Couplings

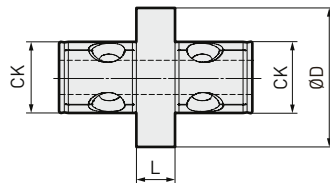

Model	Order No.	CK	ØD	L
DC-CKN6-CKN6-20	331.865N	CKN6	63.5	20
DC-CKN7-CKN7-25	331.875N	CKN7	90	25
DC-CKN7-CKN7-50	331.876N	CKN7	90	50

CKN7 - CKN6 Double Connector Reductions

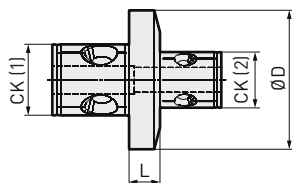

Model	Order No.	CK (1)	CK (2)	ØD	L
DC-CKN7-CKN6-20	332.875N	CKN7	CKN6	90	20

Combination Example of Extensions and Reduction

CKN-CKN Extensions

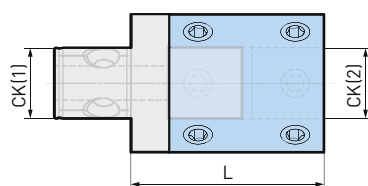

CK(1)	CK(2)	L	Double Connector	Extension	Weight (kg)
CKN6	CKN6	80	331.864N	331.867N	0.97
		100	331.865N		1.5
		120	331.864N	331.868N	1.3
		140	331.865N		1.8
CKN7	CKN7	100	331.874N	331.877N	2.5
		125	331.875N		3.1
		150	331.874N	331.879N	3.2
		150	331.876N		4.2
		175	331.875N	331.879N	3.8
		200	331.874N		4.0
		200	331.876N	331.879N	5.0
		225	331.875N		331.878N
		250	331.876N	5.7	

1. L and weight shown are as a combination of the double connector and extension.

CKN-CKB Extension

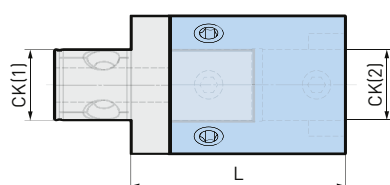

CK(1)	CK(2)	L	Double Connector	Extension	Weight (kg)
CKN6	CKB6	80	331.864N	331.860N	1.0
		100	331.865N		1.5
		120	331.864N	331.861N	1.3
		140	331.865N		1.8
CKN7	CKB7	100	331.874N	331.870N	2.4
		125	331.875N		4.0
		150	331.874N	331.871N	3.2
		150	331.876N		4.1
		175	331.875N	331.871N	3.7
		200	331.876N		4.9

1. L and weight shown are as a combination of the double connector and extension.

CKN-CKN Reductions

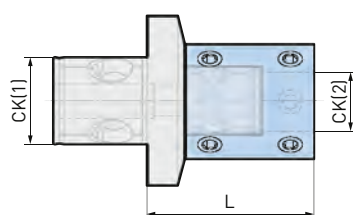

CK(1)	CK(2)	L	Double Connector	Extension	Weight (kg)
CKN7	CKN6	100	332.875N	331.867N	2.2
		140		331.868N	2.5

1. L and weight shown are as a combination of the double connector and extension.

CKN-CKB Reductions

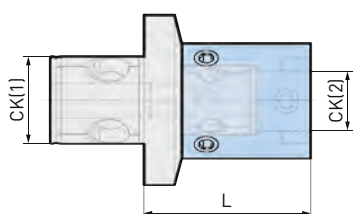

Fig. 1

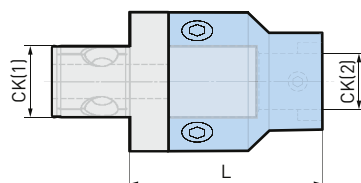

Fig. 2

CK(1)	CK(2)	Fig.	L	Double Connector	Extension/Reduction	Weight (kg)
CKN7	CKB6	1	100	332.875N	331.860N	2.1
			140		331.861N	2.2
		2	100	331.875N	332.870N	3.3
			125		332.870N	2.5
			150		332.870N	3.8
			150			3.8

1. L and weight shown are as a combination of the double connector and extension/reduction.

End Mill Holders

For end mills with cylindrical shank and clamping surface according to DIN 1835B (Weldon system) and to DIN 1835E (Whistle notch system).

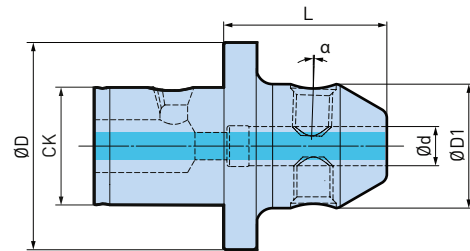
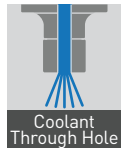

A.5

Model	Order No.	CK	Ød	ØD	ØD1	L	α
CKB4-MC6	335.230	CKB4	6	39	24	50	2°
CKB4-MC8	335.231	CKB4	8	39	26	50	2°
CKB4-MC10	335.232	CKB4	10	39	32	55	2°
CKB4-MC12	335.233	CKB4	12	39	39	60	2°
CKB5-MC6	335.234	CKB5	6	50	24	50	2°
CKB5-MC8	335.235	CKB5	8	50	26	50	2°
CKB5-MC10	335.236	CKB5	10	50	32	55	2°
CKB5-MC12	335.237	CKB5	12	50	38	60	2°
CKB5-MC14	335.238	CKB5	14	50	40	60	2°
CKB5-MC16	335.239	CKB5	16	50	45	62	2°
CKB5-MC20	335.249	CKB5	20	50	48	60	2°
CKB6-MC6	335.240	CKB6	6	63.5	24	45	2°
CKB6-MC8	335.241	CKB6	8	63.5	26	45	2°
CKB6-MC10	335.242	CKB6	10	63.5	32	45	2°
CKB6-MC12	335.243	CKB6	12	63.5	38	50	2°
CKB6-MC14	335.244	CKB6	14	63.5	40	50	2°
CKB6-MC16	335.245	CKB6	16	63.5	45	50	2°
CKB6-MC18	335.246	CKB6	18	63.5	47	50	2°
CKB6-MC20	335.247	CKB6	20	63.5	48	55	2°
CKB6-MC25	335.248	CKB6	25	63.5	63.5	65	2°
CKB7-MC32 *	335.250	CKB7	32	90	72	80	2°
CKB7-MC40 *	335.251	CKB7	40	90	80	90	2°

1. * Only for DIN 1835B tools (Weldon system).

Milling Cutter Arbors

For milling cutters with longitudinal or transverse key ways according to DIN 841, 842, 1880 and cutter heads according to DIN 1830.

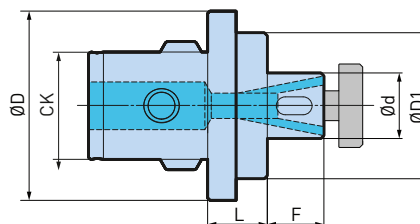
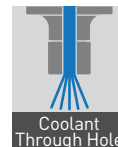

Model	Order No.	CK	Ød	ØD	ØD1	L	F
CKB4-CMA16	335.420	CKB4	16	39	37	18	17
CKB4-CMA22	335.421	CKB4	22	39	42	18	19
CKB5-CMA16	335.423	CKB5	16	50	40	20	17
CKB5-CMA22	335.424	CKB5	22	50	47	20	19
CKB5-CMA27	335.425	CKB5	27	50	53	20	21
CKB6-CMA16	335.430	CKB6	16	63.5	40	20	17
CKN6-CMA16 *	335.430N	CKN6	16	63.5	40	20	17
CKB6-CMA22	335.431	CKB6	22	63.5	50	20	19
CKN6-CMA22 *	335.431N	CKN6	22	63.5	50	20	19
CKB6-CMA27	335.432	CKB6	27	63.5	58	20	21
CKB6-CMA32	335.433	CKB6	32	63.5	70	28	24
CKB6-CMA40	335.434	CKB6	40	63.5	80	28	27
CKB7-CMA32	335.435	CKB7	32	90	83	28	24
CKB7-CMA40	335.436	CKB7	40	90	93	28	27

1. * As long as stock lasts.

Milling Chucks

With needle-bearing chucking nut for maximum clamping force and high concentricity.

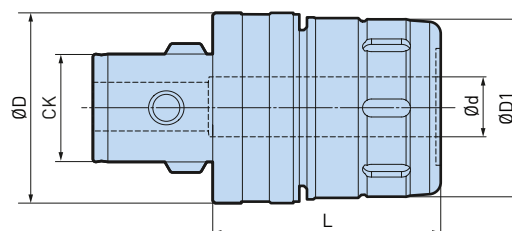
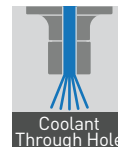

Model	Order No.	CK	Ød	ØD	ØD1	L
CKB5-HMC20S *	807.572	CKB5	20	63,5	50	57
CKB6-HMC20 *	335.066	CKB6	20	63,5	60	56
CKB7-HMC32	335.077	CKB7	32	90	80	102

A.5

1. Wrench (FK) is included.
2. Straight collets C and OCA are applicable.
3. * OCA collet can not be used.

Accessories & Spare Parts

OCA Collets	C Collets	FK Wrenches
		
▶ 348	▶ 349	▶ 352

Universal Drill Chucks

With strong clamping force and high runout accuracy. Quick and simple clamping over a bevel gear.

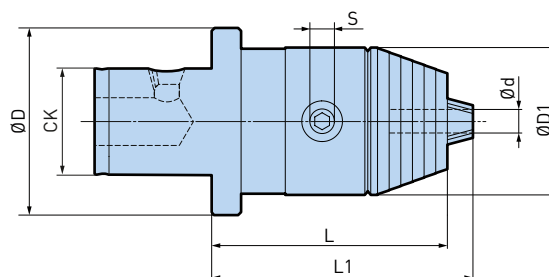

Model	Order No.	CK	Ød	ØD	ØD1	L	L1	S
CK6-DC13	335.042	CK6	1 - 13	63.5	50	81	90	6
CKB6-DC16	335.044	CK6	3 - 16	63.5	57	86	92	6

1. Wrench is included.

Accessories & Spare Parts

Wrenches

▶ 500

ER Collet Chucks

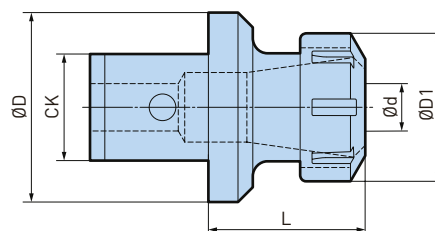
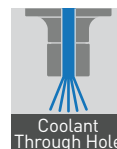
For slotted double-taper collets with extraction groove, according to DIN 6499.



Model	Order No.	CK	Ød	ØD	ØD1	L	Collet Model
CKB4-ER25	335.140	CKB4	2.75 - 16	39	42	47	ER25
CKB5-ER25	335.142	CKB5	2.75 - 20	50	42	47	ER25
CKB6-ER32	335.164	CKB6	2.75 - 25	64	50	53	ER32
CKB6-ER40	335.165	CKB6	2 - 25	64	63	65	ER40

1. Nut is included.
2. ER collets are to be ordered separately.

A.5

Accessories & Spare Parts

<p>MEGA ER Collets</p> <p>► 342</p>	<p>ER Nuts</p> <p>► 344</p>
--	------------------------------------

ER Collet Adapters

Enables the use of all BIG KAISER fine and rough boring heads of corresponding sizes - CKB1 / CKB2 (ER 25 / 32) on ER collet holders.

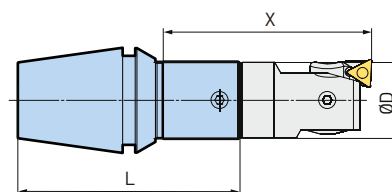
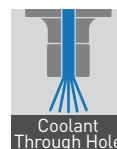

Model	Order No.	CK	ØD	L	X
ER25-CKB1-50	335.130	CKB1	19	55	50
ER32-CKB1-50	335.131	CKB1	19	61	50
ER32-CKB2-50	335.132	CKB2	24	58	50

Accessories & Spare Parts

<p>ER Nuts</p> <p>► 344</p>

MEGA Synchro Tapping Holder

Compensates for synchronization errors during rigid tapping. Improves thread quality and tool life by reducing thrust loads caused by synchronization errors up to 90%.

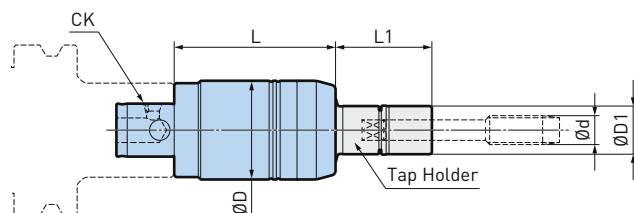
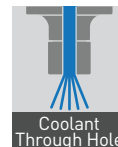

A.5

Model	Order No.	CK	Tap Holder	Ød	ØD	L	L1
CKB4-MGT6-62	335.764	CKB4	MGT6	M2 - M6	36	62	30 - 200
CKB4-MGT12-67	335.768	CKB4	MGT12	M6 - M12	41	67	30 - 200
CKB5-MGT20-87	335.769	CKB5	MGT20	M12 - M20	54	87	35 - 150

1. Tap holder is to be ordered separately.
2. Synchronized tapping function is required on the machine.

MEGA Synchro Tapping Holder MGT36

For large Tapping: Type MGT36

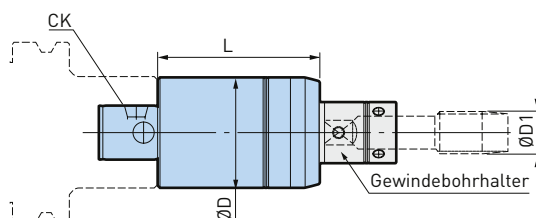
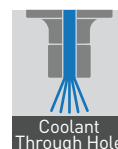

Model	Order No.	CK	Tap Holder	ØD	ØD1	L
CKB7-MGT36-137	800.949	CKB7	MGT36	94	38-52	137

1. Tap holder is to be ordered separately.
2. Synchronized tapping function is required on the machine.

Accessories & Spare Parts

Tap Holder	MEGA Wrenches	Accessories
<p>► 356-363</p>	<p>► 351</p>	<p>► 364-365</p>

Tapping Holders

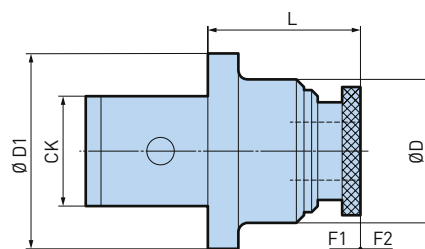

Model	Order No.	CK	ØD	ØD1	L	F1	F2
CK6-ATE12E	335.762	CK6	47	63.5	50	5	10
CK6-ATE24E	335.763	CK6	64	63.5	80	7	14

1. F1 = length compensation compression.
2. F2 = length compensation extension.
3. Please contact BIG KAISER agent for tap collet.

A.5

Blanks

The CK connector is hardened and ground. The blank is unhardened and unground.

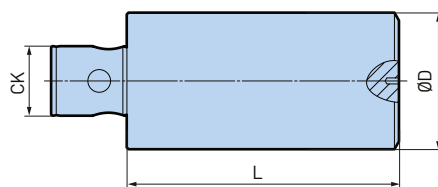

Fig. 1

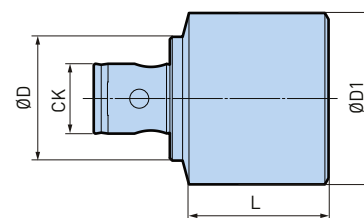
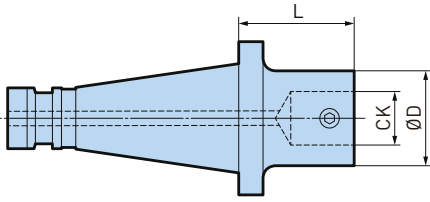

Fig. 2

Model	Order No.	Fig.	CK	ØD	ØD1	L
CKB3-31-65	335.531	1	CKB3	31	31	65
CKB3-42-50	335.532	2	CKB3	31	42	50
CKB4-39-80	335.541	1	CKB4	39	39	80
CKB4-54-50	335.542	2	CKB4	39	54	50
CKB5-50-100	335.551	1	CKB5	50	50	100
CKB5-70-60	335.552	2	CKB5	50	70	60
CKB6-64-120	335.561	1	CKB6	64	64	120
CKB6-64-220	335.563	1	CKB6	64	64	220
CKB6-97-70	335.562	2	CKB6	64	97	70
CKB7-90-180	335.571	1	CKB7	90	90	180

DIN 2080 Tool Holders



Model	Order No.	CK	ØD	L
DV40-DIN2080-CKB5-39	321.451	CKB5	50	39
DV40-DIN2080-CKB6-45	321.462	CKB6	63.5	45
DV50-DIN2080-CKB6-49 *	323.780	CKB6	63.5	49
DV50-DIN2080-CKB7-63 *	323.781	CKB7	90	63

A.5 Morse Taper shanks with thread (SIP/Hauser)

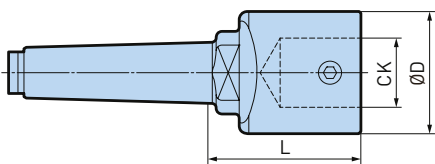

Model	Order No.	CK	ØD	L
MK4-CKB6-81	322.563	CKB6	63.5	81

Morse Taper shanks with tang

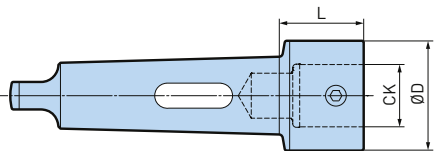

Model	Order No.	CK	ØD	L
MK5-CKB6-55	323.563	CKB6	63.5	55

Morse Taper shanks with tang

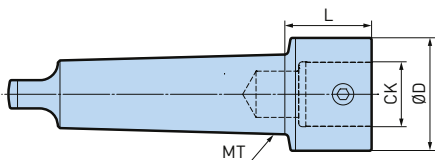

Model	Order No.	CK	ØD	L
MT3-CKB1-47	806.671	CKB1	19	47
MT3-CKB2-68	806.712	CKB2	24	67.5
MT3-CKB3-64	806.713	CKB3	31	64
MT3-CKB5-48	806.714	CKB5	50	48
MT4-CKB1-52	806.715	CKB1	19	51.5
MT4-CKB2-74	806.716	CKB2	24	74
MT4-CKB3-66	806.717	CKB3	31	65.5
MT4-CKB4-60	806.718	CKB4	39	59.5
MT4-CKB5-50	806.719	CKB5	50	49.5
MT4-CKB6-61	806.720	CKB6	64	60.5
MT5-CKB4-86	806.721	CKB4	39	85.5
MT5-CKB5-75	806.722	CKB5	50	74.5
MT5-CKB6-61	806.723	CKB6	64	60.5
MT6-CKB6-61	806.724	CKB6	64	60.5

Tool Holders Cylindrical Shank

MEGA Micro Chuck	264
New Baby Chuck	265
Hydraulic Chucks	267
New Hi-Power Milling Chuck	268
Shrink Chuck	269
CK Shanks	271
MW Rough Boring Heads	272
MEGA Synchro Tapping Holder	273
Other Products	275



MEGA Micro Chuck

Ultra small diameter ($\varnothing 10 - \varnothing 18$) to minimize interference. High precision is guaranteed in combination with MEGA New Baby Chuck.

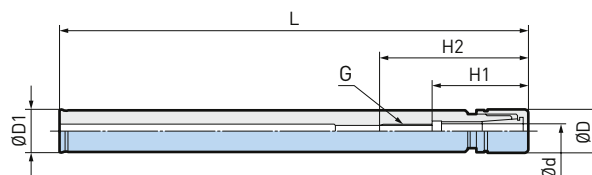
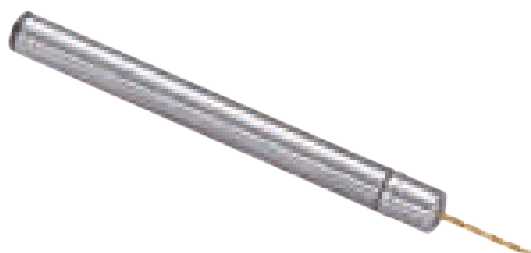

$\varnothing 0.45 - 8.05\text{mm}$

Model	Order No.	$\varnothing d$	$\varnothing D$	$\varnothing D1$	L	H1	H2	G	Collet Model	Nut Model
ST10-MEGA3S-120	961.777	0.45 - 3.25	10	10	120	22	38	M4 P0.7	NBC3S	MGN3S
ST12-MEGA4S-130	961.773	0.45 - 4.05	12	12	130	26.5	47	M5 P0.8	NBC4S	MGN4S
ST12-MEGA4S-160	961.778	0.45 - 4.05	12	12	160	26.5	47	M5 P0.8	NBC4S	MGN4S
ST14-MEGA6S-160	961.774	0.45 - 6.05	14	14	160	28.5	49	M7 P0.75	NBC6S	MGN6S
ST14-MEGA6S-200	961.779	0.45 - 6.05	14	14	200	28.5	49	M7 P0.75	NBC6S	MGN6S
ST16-MEGA8S-160	803.596	2.95 - 8.05	18	16	160	31	50.5	M9 P0.75	NBC8S	MGN8S
ST16-MEGA8S-200	805.575	2.95 - 8.05	18	16	200	31	50.5	M9 P0.75	NBC8S	MGN8S

1. MEGA nut is included in delivery.

MEGA Micro Chuck Set

Including convenient storage case.



Set Model	Order No.
SST12-MEGA4S-130	961.775

Contents

- Body / ST12 - MEGA4S - 130 (with MGN4S nut)
- Collet / NBC4S - 3.0 & 4.0 (2 pcs.)
- Wrench / MGR12

Set Model	Order No.
SST14-MEGA6S-160	961.776

Contents







- Body / ST14 - MEGA6S - 160 (with MGN6S nut)
- Collet / NBC6S - 3.0, 4.0, 5.0 & 6.0 (4 pcs.)
- Wrench / MGR14

Set Model	Order No.
SST16-MEGA8S-160	805.412

Contents

- Body / ST16 - MEGA8S - 160 (with MGN8S nut)
- Collet / NBC8S - 3.0, 4.0, 6.0 & 8.0 (4 pcs.)
- Wrench / MGR18

Accessories & Spare Parts

MEGA Nuts	Micro Seal Nuts	Micro Collets	MEGA Wrenches	Collet Protective Cases	Taper Cleaners
					
▶ 326	▶ 326	▶ 324	▶ 351	▶ 326	▶ 370

New Baby Chuck

Avoids interference when used in combination with BIG KAISER New Hi-Power Milling Chuck.

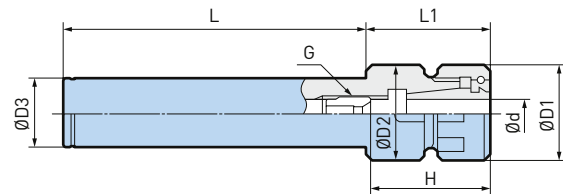

ø0.25 - 20mm

Model	Order No.	Ød	ØD1	ØD2	ØD3	L	L1	H	Collet Model
ST20-NBS6-100	961.701	0.25 - 6	20	19.5	20	100	24	20 - 40	NBC6
ST20-NBS6-150	961.702	0.25 - 6	20	19.5	20	150	24	20 - 40	NBC6
ST20-NBS6-250	961.703	0.25 - 6	20	19.5	20	250	24	20 - 40	NBC6
ST20-NBS8-100	961.706	0.5 - 8	25	24.5	20	100	26	23 - 43	NBC8
ST20-NBS8-150	961.707	0.5 - 8	25	24.5	20	150	26	23 - 43	NBC8
ST20-NBS8-250	961.708	0.5 - 8	25	24.5	20	250	26	23 - 43	NBC8
ST20-NBS10-100	961.711	1.5 - 10	30	29.5	20	100	28	35 - 45	NBC10
ST20-NBS10-150	961.712	1.5 - 10	30	29.5	20	150	28	35 - 45	NBC10
ST20-NBS10-250	961.713	1.5 - 10	30	29.5	20	250	28	35 - 45	NBC10
ST20-NBS10-350	961.714	1.5 - 10	30	29.5	20	350	28	35 - 45	NBC10
ST25-NBS6-150	961.716	0.25 - 6	20	19.5	25	150	24	20 - 40	NBC6
ST25-NBS6-200	961.717	0.25 - 6	20	19.5	25	200	24	20 - 40	NBC6
ST25-NBS6-250	961.718	0.25 - 6	20	19.5	25	250	24	20 - 40	NBC6
ST25-NBS8-150	961.721	0.5 - 8	25	24.5	25	150	26	23 - 42	NBC8
ST25-NBS8-200	961.722	0.5 - 8	25	24.5	25	200	26	23 - 42	NBC8
ST25-NBS8-250	961.723	0.5 - 8	25	24.5	25	250	26	23 - 42	NBC8
ST25-NBS10-150	961.726	1.5 - 10	30	29.5	25	150	28	35 - 45	NBC10
ST25-NBS10-200	961.727	1.5 - 10	30	29.5	25	200	28	35 - 45	NBC10
ST25-NBS10-250	961.728	1.5 - 10	30	29.5	25	250	28	35 - 45	NBC10
ST25-NBS13-150	961.731	2.5 - 13	35	34.5	25	150	34	41 - 60	NBC13
ST25-NBS13-200	961.732	2.5 - 13	35	34.5	25	200	34	41 - 60	NBC13
ST25-NBS13-250	961.733	2.5 - 13	35	34.5	25	250	34	41 - 60	NBC13

continues on the next page



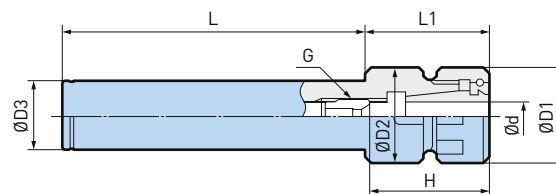

A.6

Model	Order No.	Ød	ØD1	ØD2	ØD3	L	L1	H	Collet Model
ST32-NBS6-150	961.736	0.25 - 6	20	19.5	32	150	24	20 - 40	NBC6
ST32-NBS6-200	961.737	0.25 - 6	20	19.5	32	200	24	20 - 40	NBC6
ST32-NBS8-150	961.741	0.5 - 8	25	24.5	32	150	26	23 - 42	NBC8
ST32-NBS8-200	961.742	0.5 - 8	20	24.5	32	200	26	23 - 42	NBC8
ST32-NBS10-150	961.746	1.5 - 10	30	29.5	32	150	28	35 - 45	NBC10
ST32-NBS10-200	961.747	1.5 - 10	30	29.5	32	200	28	35 - 45	NBC10
ST32-NBS10-250	961.748	1.5 - 10	30	29.5	32	250	28	35 - 45	NBC10
ST32-NBS10-350	961.749	1.5 - 10	30	29.5	32	350	28	35 - 45	NBC10
ST32-NBS13-150	961.751	2.5 - 13	35	34.5	32	150	34	41 - 60	NBC13
ST32-NBS13-200	961.752	2.5 - 13	35	34.5	32	200	34	41 - 60	NBC13
ST32-NBS13-250	961.753	2.5 - 13	35	34.5	32	250	34	41 - 60	NBC13
ST32-NBS13-300	961.754	2.5 - 13	35	34.5	32	300	34	41 - 60	NBC13
ST32-NBS16-150	961.756	2.5 - 16	42	41.5	32	150	34	45 - 65	NBC16
ST32-NBS16-200	961.757	2.5 - 16	42	41.5	32	200	34	45 - 65	NBC16
ST32-NBS16-300	961.758	2.5 - 16	42	41.5	32	300	34	45 - 65	NBC16
ST32-NBS20-150	961.761	2.5 - 20	46	45.5	32	150	34	48 - 65	NBC20
ST32-NBS20-200	961.762	2.5 - 20	46	45.5	32	200	34	48 - 65	NBC20
ST32-NBS20-300	961.763	2.5 - 20	46	45.5	32	300	34	48 - 65	NBC20

1. New Baby Nut is included.
2. "G" is the adjusting screw (optional).
3. "H" is the max. tool shank length that can be inserted for these models.

Accessories & Spare Parts

<p>New Baby Nuts</p>  <p>▶ 334</p>	<p>Baby Perfect Seals</p>  <p>▶ 338</p>	<p>New Baby Collets</p>  <p>▶ 327</p>	<p>New Baby Wrenches</p>  <p>▶ 352</p>	<p>Adjusting Screws NBA</p>  <p>▶ 335</p>	<p>Taper Cleaners</p>  <p>▶ 370</p>
---	--	--	---	--	--

Hydraulic Chuck Super Slim

Ultra precise hydraulic chuck with extremely slim design.

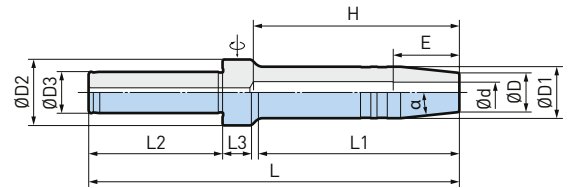
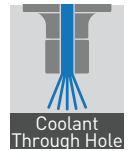

Fig. 1

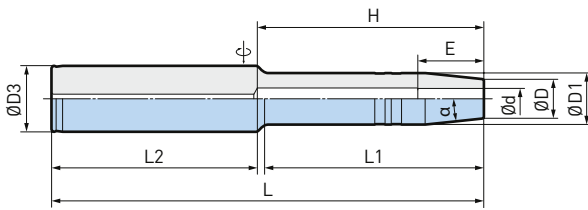

Fig. 2

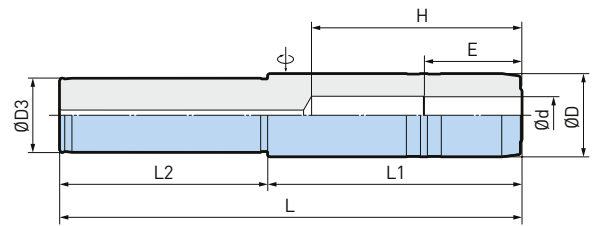

Fig. 3

A.6

ø4 - 20mm

Model	Order No.	Fig.	Ød	ØD	ØD1	ØD2	ØD3	L	L1	L2	H	E	α
ST20-HDC4S-180	805.835	1	4	14	18	32	20	180	94	65	-	19	6°
ST20-HDC6S-180	805.836	1	6	14	20	32	20	180	95	65	101	25	6°
ST20-HDC8S-180	805.837	1	8	17	23	32	20	180	96	65	101	31	6°
ST20-HDC10S-180	805.838	1	10	19	25	32	20	180	97	65	100	33	6°
ST20-HDC12S-180	805.839	1	12	21	28	32	20	180	99	65	100	36	6°
ST32-HDC10S-210	805.595	2	10	19	25	-	32	210	106	100	110	33	6°
ST32-HDC12S-210	805.560	2	12	21	28	-	32	210	108	100	109	36	6°
ST32-HDC16-200	805.840	3	16	36	-	-	32	200	110	90	91	43	-
ST32-HDC20-200	805.841	3	20	38	-	-	32	200	110	90	90	43	-

1. Adjusting screw cannot be used.
2. Use carbide cutter within a tolerance of h6.
3. "E" is the min. clamping length.
4. "H" is the max. tool shank length that can be inserted for these models.

Accessories & Spare Parts

<p>PJC Collets</p>  <p>▶ 347</p>	<p>PSC Collets</p>  <p>▶ 348</p>	<p>Wiper Cleaners</p>  <p>▶ 370</p>
---	---	--

New Hi-Power Milling Chuck HMC12J

Extremely slim and rigid design with jet through coolant.

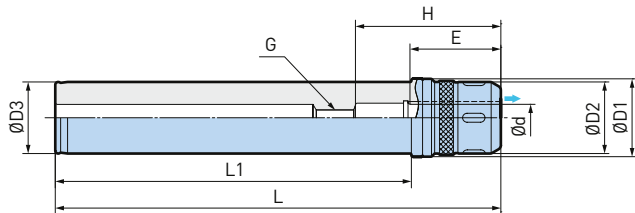
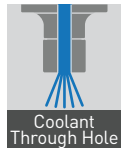

A.6

ø6 - 12mm

Model	Order No.	Ød	ØD1	ØD2	ØD3	L	L1	H	E	G
ST32-HMC12J-120	805.842	12	35	32	32	120	80	65	43	M8
ST32-HMC12J-160	805.843	12	35	32	32	160	120	65	43	M8
ST32-HMC12J-200	805.844	12	35	32	32	200	160	65	43	M8

1. Wrench is to be ordered separately.
2. "E" is the min. clamping length.
3. "H" is the max. tool shank length that can be inserted for these models.

Accessories & Spare Parts

<p>PJC Collets</p> <p>► 347</p>	<p>FK Wrenches</p> <p>► 352</p>
---------------------------------	---------------------------------

Shrink Chuck Super Slim

Slim design reduces interference contours of the holder

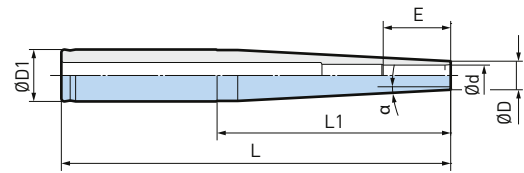
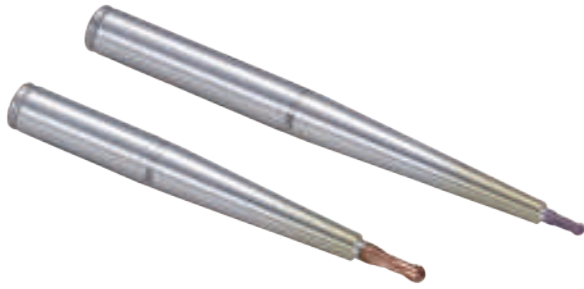

Fig. 1

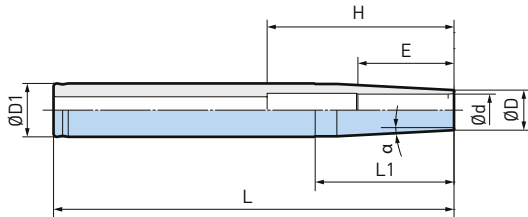

Fig. 2

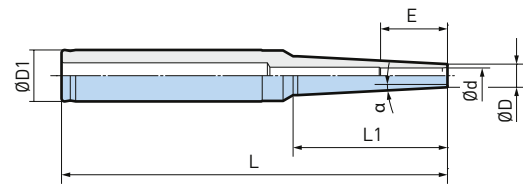

Fig. 3

A.6

ø4 - 12mm

Model	Order No.	Fig.	Ød	ØD	ØD1	L	L1	H	E	α
ST12-SRC4SS-120	802.189	1	4	7	12	120	51	-	16	3°
ST12-SRC6SS-120	802.190	2	6	9	12	120	32	52	26	3°
ST20-SRC6SS-200	802.210	1	6	9	20	200	110	-	26	3°
ST20-SRC6SS-250	802.212	1	6	9	20	250	110	-	26	3°
ST20-SRC8SS-150	802.217	1	8	11	20	150	90	-	26	3°
ST20-SRC8SS-200	802.218	1	8	11	20	200	90	-	26	3°
ST20-SRC8SS-250	802.219	1	8	11	20	250	90	-	26	3°
ST20-SRC10SS-150	802.197	2	10	13	20	150	71	60	32	3°
ST20-SRC10SS-200	802.198	2	10	13	20	200	71	60	32	3°
ST20-SRC10SS-250	802.199	2	10	13	20	250	71	60	32	3°
ST20-SRC12SS-150	802.200	2	12	15	20	150	52	70	36	3°
ST20-SRC12SS-200	802.201	2	12	15	20	200	52	70	36	3°
ST20-SRC12SS-250	802.202	2	12	15	20	250	52	70	36	3°
ST20-SRC4SS-150-K40	802.205	3	4	7	20	150	40	-	16	3°
ST20-SRC6SS-150-K60	802.209	3	6	9	20	150	60	-	26	3°

1. Use carbide cutter within a tolerance of h6.
2. "E" is the min. clamping length.
3. "H" is the max. tool shank length that can be inserted for these models.
4. Please refer to the operation manual of heating / cooling equipment, as some equipment may not be compatible.

Accessories & Spare Parts

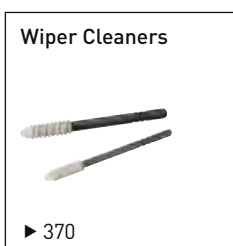

Shrink Chuck Slim

Slim design reduces interference contours of the holder.

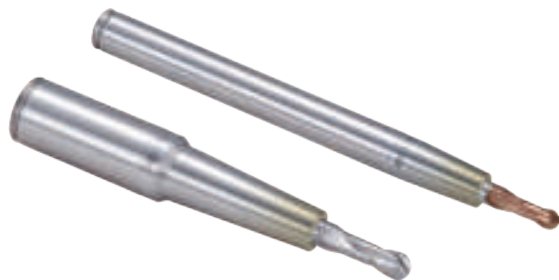
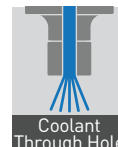

A.6

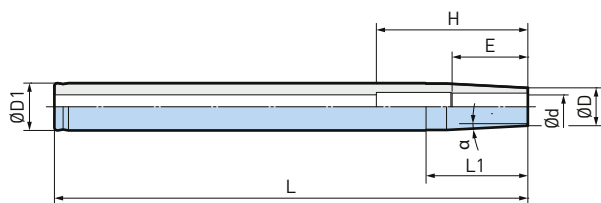

Fig. 1

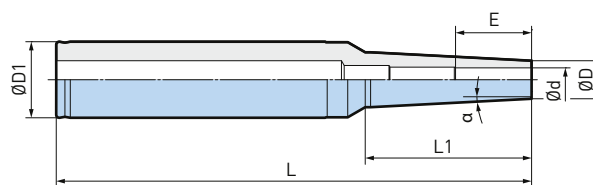

Fig. 2

ø12 - 20mm

Model	Order No.	Fig.	Ød	ØD	ØD1	L	L1	H	E	α
ST32-SRC16S-150	802.245	1	16	24	32	150	83	70	38	3°
ST32-SRC16S-200	802.246	1	16	24	32	200	83	80	38	3°
ST32-SRC16S-300	802.247	1	16	24	32	300	83	80	38	3°
ST32-SRC20S-150	802.248	1	20	28	32	150	50	80	38	3°
ST32-SRC20S-200	802.249	1	20	28	32	200	50	80	38	3°
ST32-SRC20S-300	802.250	1	20	28	32	300	50	80	38	3°
ST32-SRC12S-150-K70	802.238	2	12	19	32	150	70	-	36	3°
ST32-SRC12S-200-K70	802.239	2	12	19	32	200	70	-	36	3°
ST32-SRC12S-300-K70	802.241	2	12	19	32	300	70	-	36	3°

1. Use carbide cutter within a tolerance of h6.
2. "E" is the min. clamping length.
3. "H" is the max. tool shank length that can be inserted for these models.
4. Please refer to the operation manual of heating / cooling equipment, as some equipment may not be compatible.

Accessories & Spare Parts

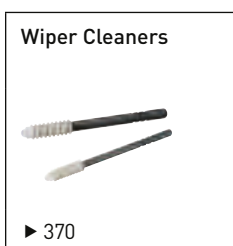



CK Shanks

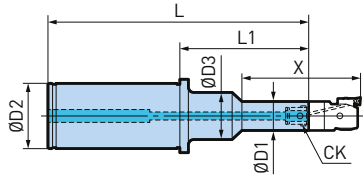

Fig. 1

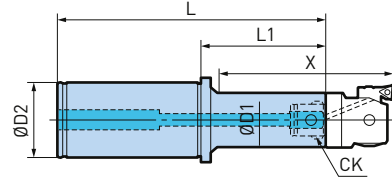

Fig. 2

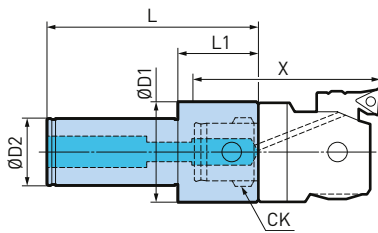

Fig. 3

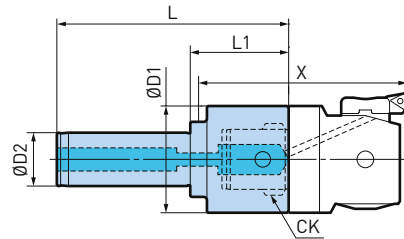

Fig. 4

CK1 - CK6

Model	Order No.	Fig.	CK	ØD1	ØD2	L	L1	X
ST32-CKB1-77	806.725	1	CKB1	19	32	157	77	73
ST32-CKB2-73	978.413	2	CKB2	24	32	152.5	72.5	100
ST32-CKB3-69	806.726	2	CKB3	31	32	149	69	100
ST32-CKB4-58	978.406	3	CKB4	39	32	138	58	100
ST32-CKB5-48	806.727	4	CKB5	50	32	128	48	100
ST32-CKB6-59	978.357	4	CKB6	64	32	139	59	125
ST42-CKB1-77	806.728	1	CKB1	19	42	157	77	73
ST42-CKB2-73	806.729	2	CKB2	24	42	152.5	72.5	100
ST42-CKB3-69	806.730	2	CKB3	31	42	149	69	100
ST42-CKB4-63	806.731	2	CKB4	39	42	143	63	100
ST42-CKB5-48	806.732	3	CKB5	50	42	128	48	100
ST42-CKB6-59	806.733	4	CKB6	64	42	139	59	125

1. X and L1 dimensions on the table are reference figures when EWN/EWE head is mounted.

Accessories & Spare Parts

Fine Boring Heads



► 396-399

MW Rough Boring Heads, \varnothing 16 - 21

The MW rough boring heads permit extremely fast roughing of small holes (\varnothing 16-21 mm).

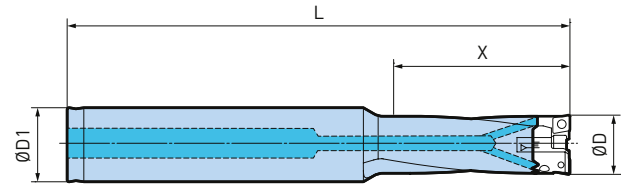

A.6

Model	Order No.	\varnothing D	\varnothing D1	L	X
ST20-MW1619-45	807.540	16 - 19	20	136	45
ST20-MW1619-60	472.051	16 - 19	20	150	60
ST20-MW1821-50	807.541	18 - 21	20	141	50
ST20-MW1821-65	472.061	18 - 21	20	155	65

1. Insert holder is to be ordered separately.

MW Rough Boring Heads, \varnothing 16 - 21 Carbide

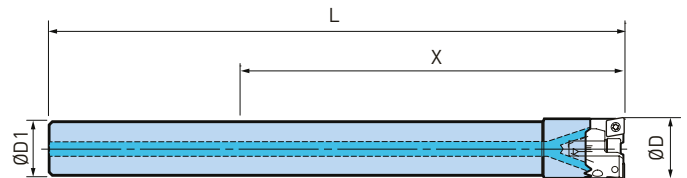

Model	Order No.	\varnothing D	\varnothing D1	L	X
ST14W-MW16-110	807.552	16 - 19	14	151	110
ST16W-MW18-115	807.553	18 - 21	16	172	115

1. Insert holder is to be ordered separately.
2. Exclusive use for through holes. Do not use with blind holes.

Accessories & Spare Parts

Insert Holders MW	Inserts MW
<p>► 382</p>	<p>► 475</p>

MEGA Synchro Tapping Holder

Compensates for synchronization errors during rigid tapping. Improves thread quality and tool life by reducing thrust loads caused by synchronization errors up to 90%.

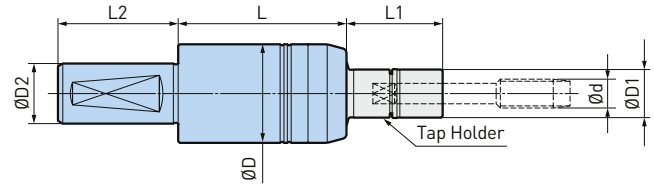

M3 - M20

Model	Order No.	Tap Holder	Ød	ØD	ØD1	ØD2	L	L1	L2
ST20-MGT6-65	963.601	MGT6	M3-M8	36	16	20	65	30 - 200	40
ST25-MGT12-70	963.602	MGT12	M5-M12 / P1/8	41	20	25	70	30 - 200	50
ST32-MGT20-90	963.603	MGT20	M10-M20 / P1/4-P1/2	54	30	32	90	35 - 150	55

A.6

1. Tap holder and wrench are to be ordered separately.
2. Synchronized tapping function is required on the machine.
3. Side lock holder model TSL is recommended as a basic holder.

Accessories & Spare Parts

Tap Holder	MEGA Wrenches	Accessories
<p>► 356-363</p>	<p>► 351</p>	<p>► 364-365</p>

MEGA Synchro Tapping Holder

For small Tap MGT3

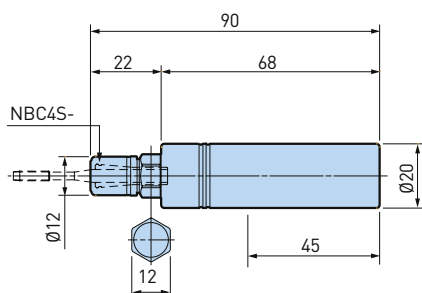

Fig. 1

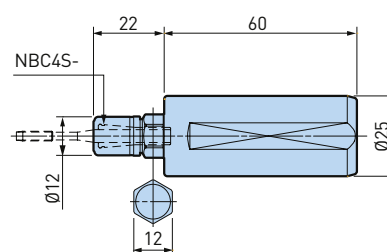

Fig. 2

A.6

Model	Order No.	Fig.
ST20-MGT3-90	978.356	1
SLS25-MGT3-22	804.115	2

1. MEGA nut is included in delivery.
2. MEGA wrench (MGR12) and common spanner (12 mm) are required to clamp/unclamp the tap.
3. 12 mm wrench is additionally required to clamp/release the tool.
4. Synchronized tapping function is required on the machine.
5. Coolant-through hole is not available.
6. ST20 has no flat on the shank.

Micro Collet for MGT3

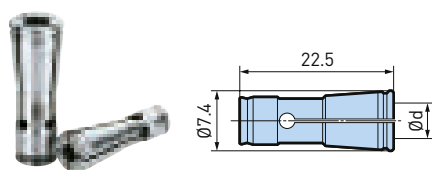

Model	Order No.	Tapping Range			Tap Shank
		DIN 371	ISO 529	JIS	$\varnothing d$
NBC4S-2.5AA	961.468	M1 - M1.8	M2		2.5
-2.8AA	968.353	M2 - M2.6	M2.2, M2.5		2.8
-3.0AA	961.470	-	-	M1 - M2.6	3.0
-3.1AA	968.355	-	M3		3.15
-3.5AA	961.472	M3	-		3.5
-4.0AA	961.474	-	-	M3	4.0

1. Other sizes available. Please refer to micro collet.

Accessories & Spare Parts

<p>Micro Collets</p>  <p>▶ 324</p>	<p>MEGA Wrenches</p>  <p>▶ 351</p>
---	---

Other products with cylindrical shank

**Point Master**

- Touch probe and edge finder
- High precision stroke and interchangeable stylus for measuring different applications

**Accu Center**

- Edge finder
- Simple and precise edge finder offering repeatability within 3 µm

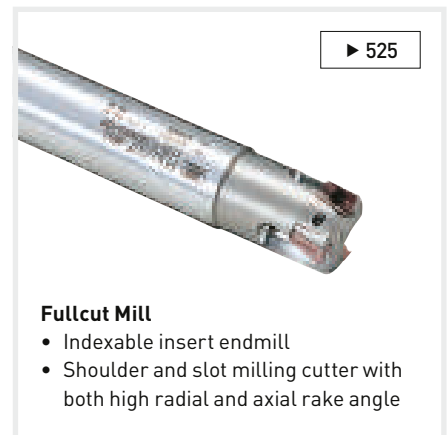
**Fullcut Mill**

- Indexable insert endmill
- Shoulder and slot milling cutter with both high radial and axial rake angle

**C-Cutter**

- Wide range chamfer mill
- Reduced number of tools and tool change time

**C-Cutter Mini**

- Ultra high feed chamfer mill
- 4 inserts and small tool diameter minimize cutting speed

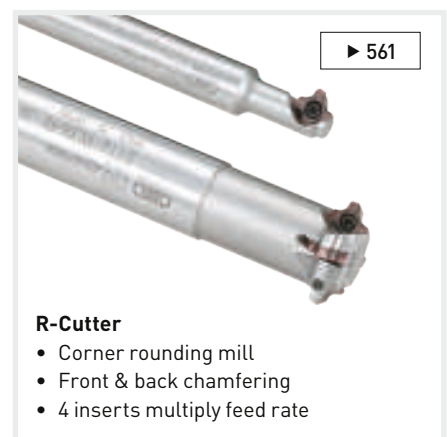
**R-Cutter**

- Corner rounding mill
- Front & back chamfering
- 4 inserts multiply feed rate

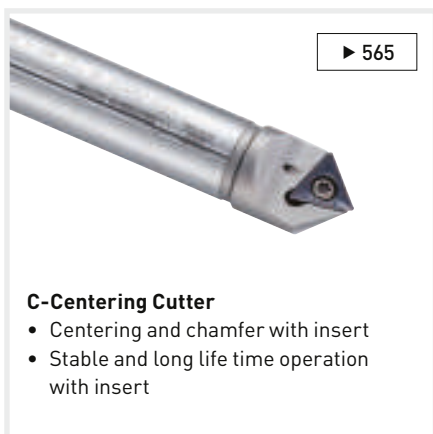
**C-Centering Cutter**

- Centering and chamfer with insert
- Stable and long life time operation with insert

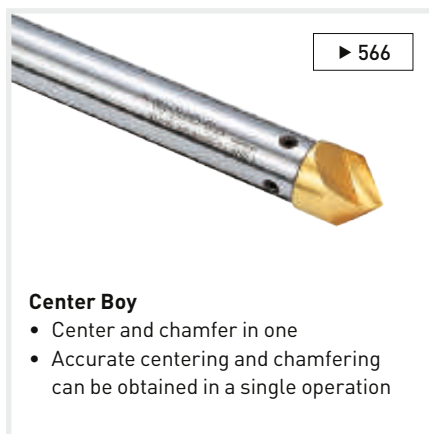
**Center Boy**

- Center and chamfer in one
- Accurate centering and chamfering can be obtained in a single operation

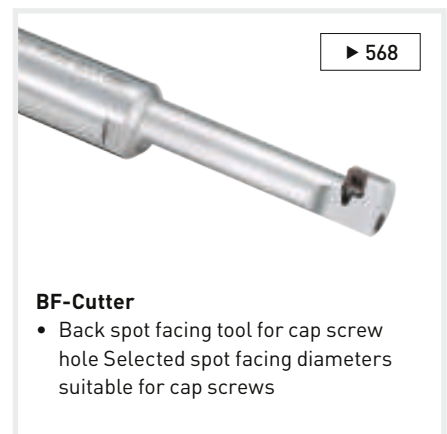
**BF-Cutter**

- Back spot facing tool for cap screw hole Selected spot facing diameters suitable for cap screws

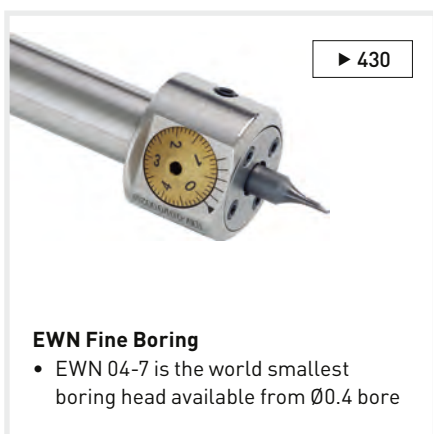
**EWN Fine Boring**

- EWN 04-7 is the world smallest boring head available from Ø0.4 bore

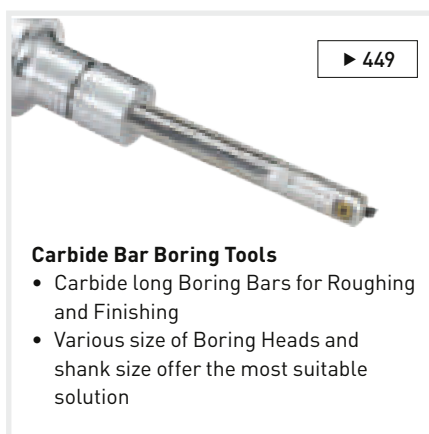
**Carbide Bar Boring Tools**

- Carbide long Boring Bars for Roughing and Finishing
- Various size of Boring Heads and shank size offer the most suitable solution

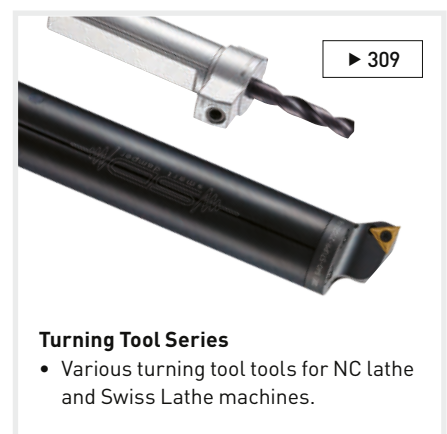
**Turning Tool Series**

- Various turning tool tools for NC lathe and Swiss Lathe machines.

Modular Turning / Lathe Tools

Modular Turning Overview	278
BBT SERIES	
Selection Guide	282
Modular Turning Tools	284
HSK-T SERIES	
Selection Guide	290
Modular Turning Tools	292
Turning Adapter	297
BIG CAPTO SERIES	
Selection Guide	298
Modular and Monoblock Turning Tools	300
Turning Adapter	308
N/C LATHE TOOLING	
Collet Chucks	309
Tapping Holder	315
Smart Damper Turning and Turning Cartridge	316
Hydraulic Chucks	318



Revolutionary modular system for turning

45° (Tilt Type) S Type



Tilting the "B" axis 45° minimizes the cutting forces transmitted to the machine spindle.

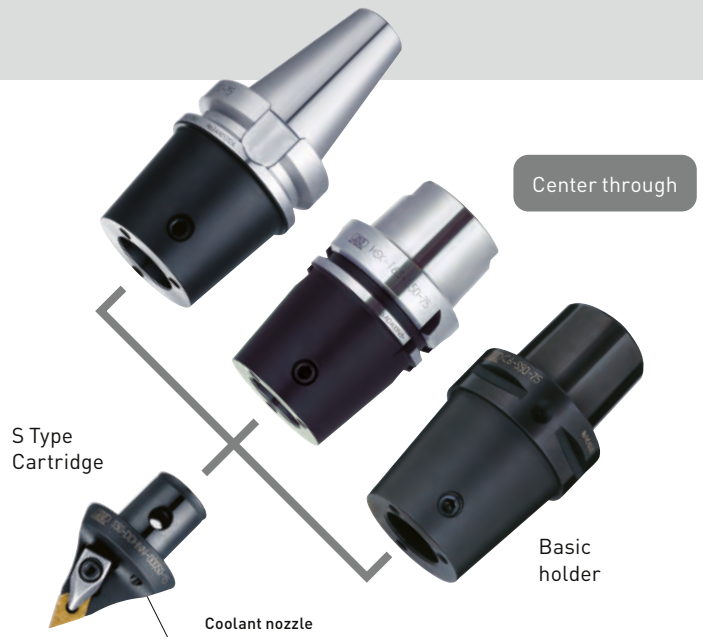

A.7

90° (Right Angle Type) F Type PAT.



Basic holder can be used with both right- and left-hand cartridges.

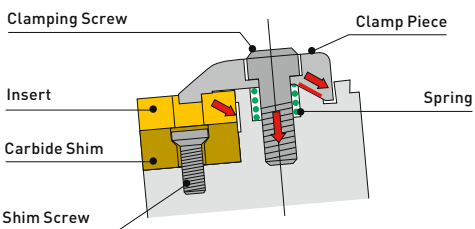

A double-clamping system that utilizes a "Push and Draw" mechanism to fix inserts securely

Secure insert clamping has been realized through the double-clamping system, which pushes the insert downwards while at the same time generating drawing force on the insert contact surface.

The issue of a valuable holder breakage caused by problems such as chipping has been eliminated through the use of a "modular system", resulting in enhanced efficiency and economy.

45° incline avoids interference with the chuck

Tool length can be minimized.

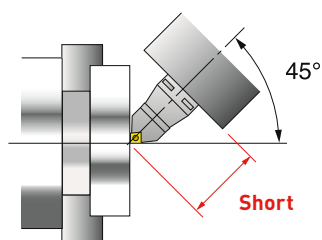

A total of 15 types of cartridges are available to support various applications

Strong clamping system

The two shallow-tapered clamping screws securely maintain contact between the cartridge and the basic holder flange face.

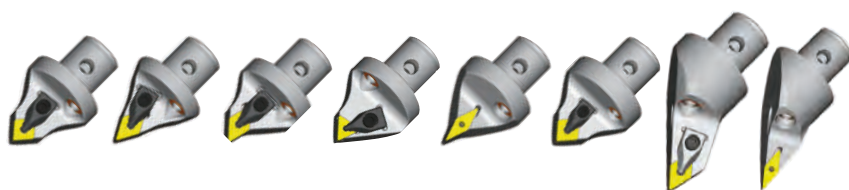
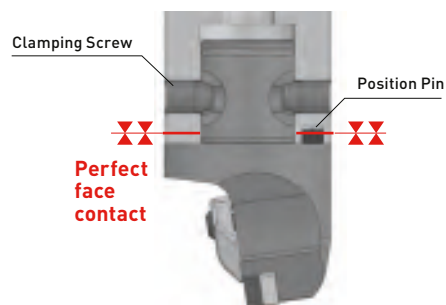

A.7

Comprehensive interference countermeasures

A series of "near-center" type cartridges are available, eliminating interference with the tailstock.

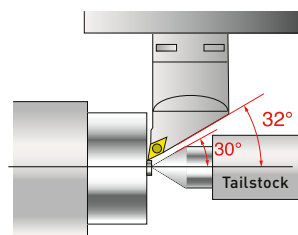

13 types of cartridges are available to support various applications

Both right hand and left hand are available.

Strong clamping system

In the F Type clamping system, cartridges are fixed using the two front clamping screws. The interlocking drive slot receives the cutting torque firmly.

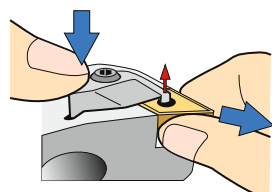

Easy attachment and removal of inserts

Insert attachment and removal can be performed easily by the built-in spring.

Loosen the clamping screw one full rotation, lightly press the clamp piece with a finger, and its tip will pop up.

45°

S Type Basic Holder

BBT40M- S50- 75
BBT50M- S50- 120

S Type (Tilt Type) Cartridge

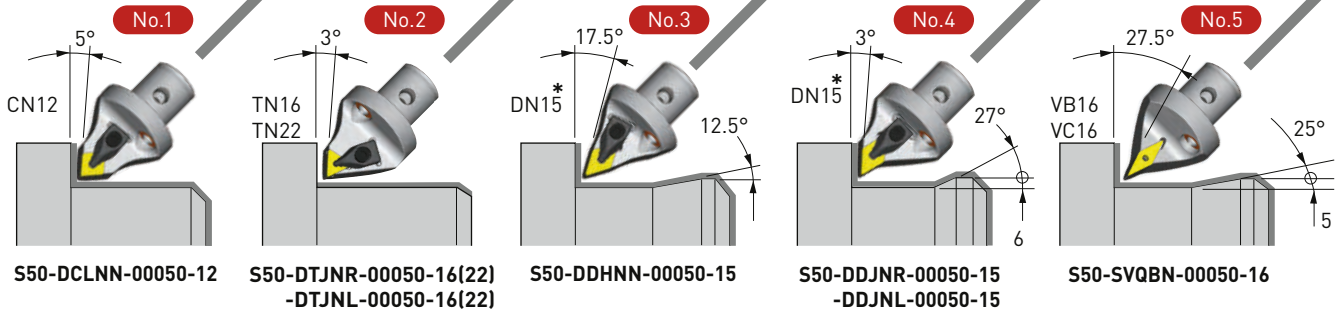
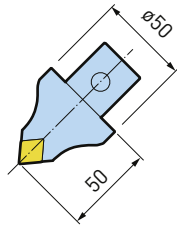

* When using a DN1506 insert (thickness: 6.35mm), replace the standard carbide shim with the DNS1506 (optional).

90°

F Type Basic Holder

BBT40M- F50- 75
 - 105
BBT50M- F63- 70
 - 130

F Type (Right Angle Type) Cartridge

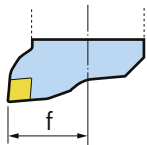

	f
F50	35
F63	45



S Type Basic Holder

S Type Cartridge

- No.1
- No.3
- No.5
- No.8

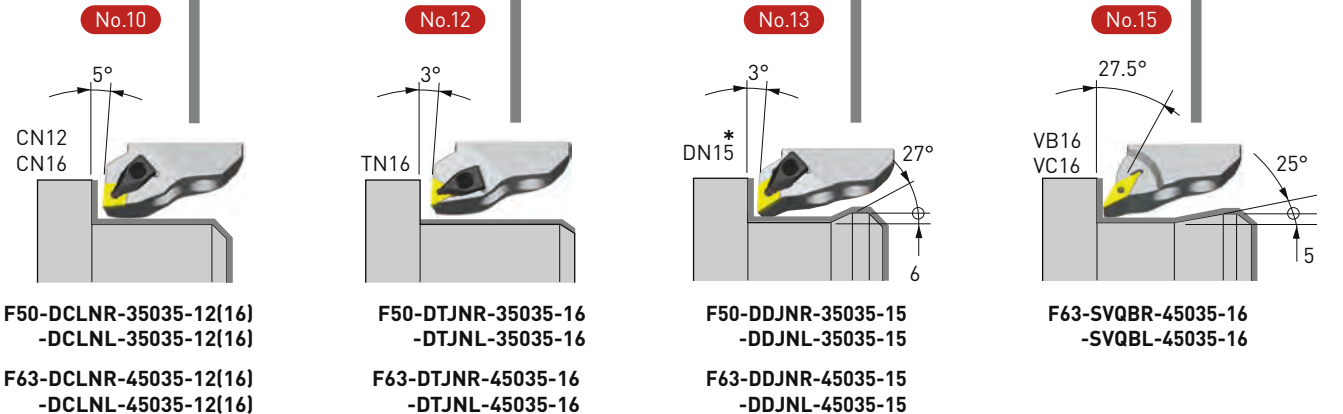

* When using a DN1506 insert (thickness: 6.35mm), replace the standard carbide shim with the DNS1506 (optional).

**S Type
Basic Holder**

BBT40M- S63- 65
BBT50M- S63- 110

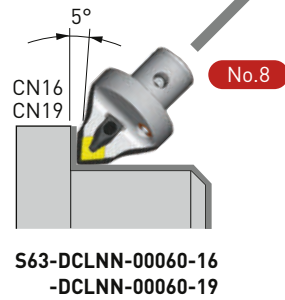
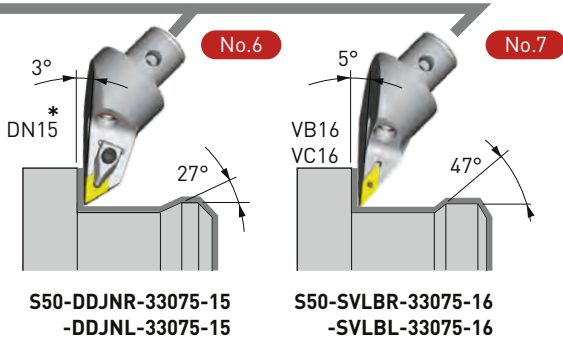
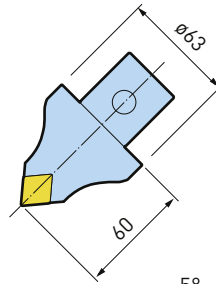
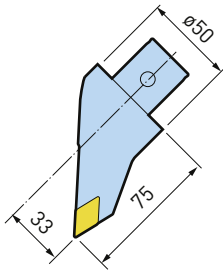

S50-DDJNR-33075-15
-DDJNL-33075-15

S50-SVLBR-33075-16
-SVLBL-33075-16

S63-DCLNN-00060-16
-DCLNN-00060-19

A.7

Internal boring bar
Internal threading tool



Side Lock Holder
for Boring Bar

Square tool



Square Tool Holder

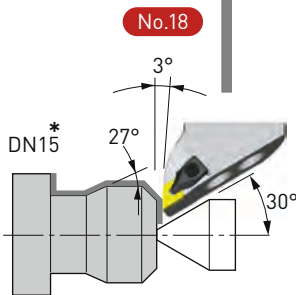

F50-DDJNR-35050-15
-DDJNL-35050-15

F63-DDJNR-45055-15
-DDJNL-45055-15

Selection Guide Table

Entering angle	Insert	Cartridge or Mono-block		Right hand	Left hand
		S Type	F Type		
95°	CN0903 (CN0904)		No.19		
	CN1204	No.1	No.10-1		
	CN1606	No.8-1	No.10-2		
	CN1906	No.8-2			
	VB1604 VC1604	No.7			
93°	TN1604	No.2-1	No.12		
	TN2204	No.2-2			
	DN1104		No.20		

A.7

Entering angle	Insert	Cartridge or Mono-block		Right hand	Left hand
		S Type	F Type		
93°	DN1504 (DN1506)	No.4	No.13		
	DN1504 (DN1506)	No.6	No.18		
107.5°	DN1504 (DN1506)	No.3			
117.5°	VB1103 VC1103		No.21		
	VB1604 VC1604	No.5	No.15		

Neutral				
Insert				
CN12	CN16	CN19	DN1504 (DN1506)	VB1604 / VC1604
No.1	No.8-1	No.8-2	No.3	No.5

45° Cartridges Type S

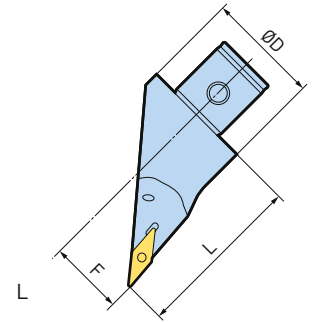
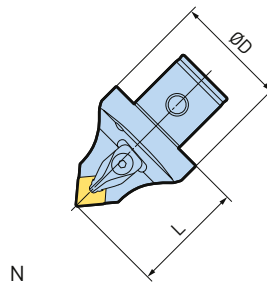

A.7

Model	Order No.	Type	Hand	ØD	L	F	Entering Angle	Clamp Piece	Insert	No.
S50-DCLNN-00050-12	973.014	S50	N	50	50	-	95°	CP2	CN1204	1
S50-DTJNR-00050-16	973.015	S50	R	50	50	-	93°	CP1	TN1604	2-1
S50-DTJNL-00050-16	973.016	S50	L	50	50	-	93°	CP1	TN1604	2-1
S50-DTJNR-00050-22	802.130	S50	R	50	50	-	93°	CP2	TN2204	2-2
S50-DTJNL-00050-22	802.129	S50	L	50	50	-	93°	CP2	TN2204	2-2
S50-DDHNN-00050-15	973.021	S50	N	50	50	-	107.5°	CP2	DN1504* (DN1506)	3
S50-DDJNR-00050-15	973.017	S50	R	50	50	-	93°	CP2	DN1504* (DN1506)	4
S50-DDJNL-00050-15	973.018	S50	L	50	50	-	93°	CP2	DN1504* (DN1506)	4
S50-DDJNR-33075-15	973.019	S50	R	50	75	33	93°	CP2	DN1504* (DN1506)	6
S50-DDJNL-33075-15	973.020	S50	L	50	75	33	93°	CP2	DN1504* (DN1506)	6
S50-SVQBN-00050-16	973.024	S50	N	50	50	-	117.5°	M3.5	VB1604** / VC1604	5
S50-SVLBR-33075-16	973.022	S50	R	50	75	33	95°	M3.5	VB1604** / VC1604	7
S50-SVLBL-33075-16	973.023	S50	L	50	75	33	95°	M3.5	VB1604** / VC1604	7
S63-DCLNN-00060-16	973.025	S50	N	63	60	-	95°	CP3	CN1606	8-1
S63-DCLNN-00060-19	805.724	S50	N	63	60	-	95°	CP5	CN1906	8-1

1. Inserts are not included.
2. Wrench is to be ordered separately.
3. * Carbide shim for 4.76 mm thick DN1504 insert is included as standard. In case of DN1506 insert (thickness of 6.35 mm), please replace the standard carbide shim with DNS1506 (option).
4. ** VB1604 and VC1604 Inserts are suitable.

Coding system for cartridge

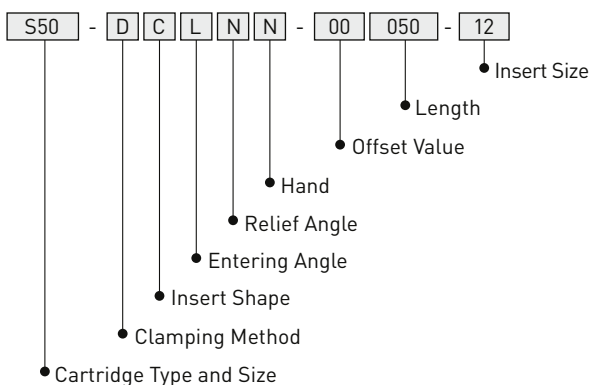

Clamping Method	
D	Double-Clamp
S	Screw-On

Insert Shape	
C	Rhombic 80°
T	Triangle 60°
D	Rhombic 55°
V	Rhombic 35°

Entering Angle	
J	93°
L	95°
H	107.5°
Q	117.5°

Relief Angle	
N	0° Negative
B	5° Positive

Hand	
R	Right Hand
L	Left Hand
N	Neutral

Accessories & Spare Parts

Spare parts for turning holders	Inserts CN	Inserts TN	Inserts DN	Inserts VB	Inserts VC
▶ 286	▶ 492	▶ 494	▶ 493	▶ 494	▶ 494

90° Cartridges Type F

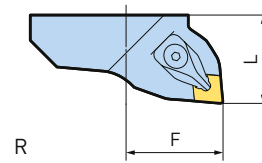

Model	Order No.	Type	Hand	Entering Angle	Insert	L	F	No.
F50-DCLNR-35035-12	973.064	F50	R	95°	CN1204	35	45	10 - 1
F50-DCLNL-35035-12	973.065	F50	L	95°	CN1204	35	45	10 - 1
F50-DCLNR-35035-16	973.066	F50	R	95°	CN1606	35	45	10 - 2
F50-DCLNL-35035-16	973.067	F50	L	95°	CN1606	35	45	10 - 2
F50-DTJNR-35035-16	973.068	F50	R	93°	TN1604	35	45	12
F50-DTJNL-35035-16	973.069	F50	L	93°	TN1604	35	45	12
F50-DDJNR-35035-15	973.070	F50	R	95°	DN1504 * (DN1506)	35	45	13
F50-DDJNL-35035-15	973.071	F50	L	95°	DN1504 * (DN1506)	35	45	13
F50-DDJNR-35050-15	973.072	F50	R	95°	DN1504 * (DN1506)	50	45	18
F50-DDJNL-35050-15	973.073	F50	L	95°	DN1504 * (DN1506)	50	45	18
F63-DCLNR-45035-12	973.076	F63	R	95°	CN1204	35	45	10 - 1
F63-DCLNL-45035-12	973.077	F63	L	95°	CN1204	35	45	10 - 1
F63-DCLNR-45035-16	973.078	F63	R	95°	CN1606	35	45	10 - 2
F63-DCLNL-45035-16	973.079	F63	L	95°	CN1606	35	45	10 - 2
F63-DTJNR-45035-16	973.080	F63	R	93°	TN1604	35	45	12
F63-DTJNL-45035-16	973.081	F63	L	93°	TN1604	35	45	12
F63-DDJNR-45035-15	973.082	F63	R	93°	DN1504 * (DN1506)	35	45	13
F63-DDJNL-45035-15	973.083	F63	L	93°	DN1504 * (DN1506)	35	45	13
F63-SVQBR-45035-16	973.086	F63	R	117.5°	VB1604 / VC1604 **	35	45	15
F63-SVQBL-45035-16	973.087	F63	L	117.5°	VB1604 / VC1604 **	35	45	15
F63-DDJNR-45055-15	973.084	F63	R	93°	DN1504 * (DN1506)	55	45	18
F63-DDJNL-45055-15	973.085	F63	L	93°	DN1504 * (DN1506)	55	45	18

A.7

1. Inserts are not included.
2. Wrench is to be ordered separately.
3. * Carbide shim for 4.76 mm thick DN1504 insert is included as standard. In case of DN1506 insert (thickness of 6.35 mm), please replace the standard carbide shim with DNS1506 (option).
4. ** VB1604 and VC1604 Inserts are suitable.

Coding system for cartridge

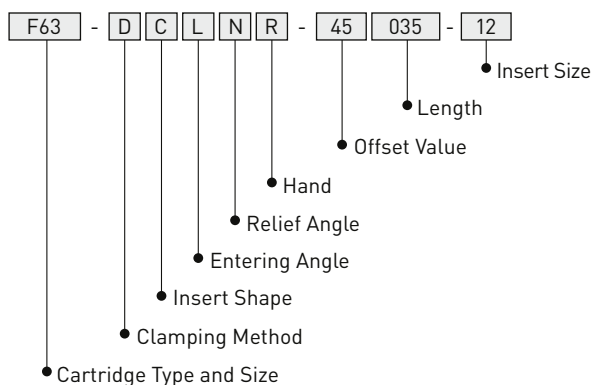

Clamping Method	
D	Double-Clamp
S	Screw-On

Insert Shape	
C	Rhombic 80°
T	Triangle 60°
D	Rhombic 55°
V	Rhombic 35°

Entering Angle	
J	93°
L	95°
H	107.5°
Q	117.5°
U	93°

Relief Angle	
N	0° Negative
B	5° Positive

Hand	
R	Right Hand
L	Left Hand
N	Neutral

Accessories & Spare Parts

Spare parts for turning holders	Inserts CN	Inserts TN	Inserts DN	Inserts VB	Inserts VC
▶ 286	▶ 492	▶ 494	▶ 493	▶ 494	▶ 494

Spare parts for turning holders

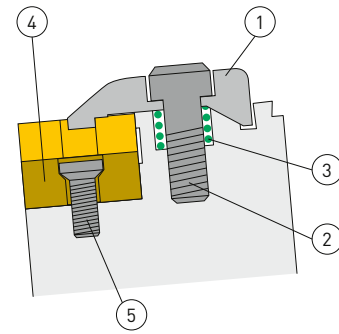

Clamp Piece Set

Model	Order No.	Clamp Piece	Clamping Screw	Spring	Insert
SCP1	973.181	CP1	M5 x 20	Ø8 x 10	TN1604
SCP2	973.182	CP2	M5 x 20	Ø8 x 10	CN1204, TN2204, DN15
SCP3	973.183	CP3	M5 x 20	Ø8 x 10	CN1606
SCP5	802.133	CP5	M5 x 20	Ø8 x 10	CN1906
SCP7	807.554	CP7	M5 x 20	Ø8 x 10	CN0903, CN0904, DN11

- 1 pce. each of the clamp piece, clamp screw and spring are included in the set.
- The tightening wrench is a 4mm hex wrench. T-type hex wrench is sold as Model T-4.
- (1) Clamp Piece (2) Clamp Screw (3) Spring

A.7

Carbide Shim Set

Model	Order No.	Insert	Carbide Shim	Clamping Screw	Torx size
SCNS0903C	807.650	CN0903	CNS0903C	M3 x 7	10IP
SCNS0904C	807.651	CN0904	CNS0904C	M3 x 7	10IP
SDNS1104C	807.556	DN1104	DNS1104C	M3 x 7	10IP
SCNS1204	973.185	CN1204	CNS1204	M4 x 8	T15
SDNS1504	973.186	DN1504	DNS1504	M4 x 8	T15
SDNS1506	973.187	DN1506	DNS1506	M4 x 8	T15
SCNS1606	973.188	CN1606	CNS1606	M5 x 12	T20
SCNS1906	802.131	CN1906	CNS1906	M5 x 12	T20
STNS1604	973.184	TN1604	TNS1604	M3 x 7	T10
STNS2204	804.821	TN2204	TNS2204	M4 x 8	T15

- 1 pce. each of the carbide shim and shim clamp screw are included in the set.
- The tightening wrench is a torx wrench. Driver-type torx wrench is sold as models DA-T10, DA-T15, and DA-T20.
- (4) Carbide Shim (5) Shim Clamp Screw

Insert Clamping Screw Set

For VB11, VC11, VB16 and VC16 insert.



Model	Order No.	Insert	Screw	Wrench
S3508DS	966.273	VB1604 / VC1604	M3.5 x 8	DA-T15
S2.5S-7IP	100763.001.0	VB1103 / VC1103	M2.5 x 6.5	FS-7IP

- 10 screws and 1 wrench are included.

Clamping screw Set

Clamping screw Set- Type S



Model	Order No.	Type
CK5S	805.891	S50
CK6S	805.892	S63

- 2 screws and 1 wrench are included

BBT(M) Basic Holder Type S (45°)

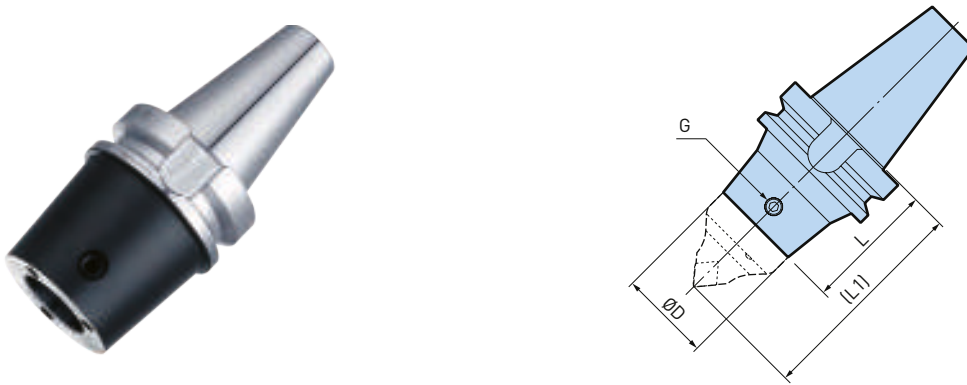

Model	Order No.	ØD	L	L1	Clamp Screw
BBT40M-S50-75	978.160	50	75	125	CK5S
BBT50M-S50-120	804.877	50	120	170	CK5S
BBT50M-S63-110	804.878	63	110	170	CK6S

1. Clamping screw is included.

A.7

BBT(M) Basic Holder Type F (90°)

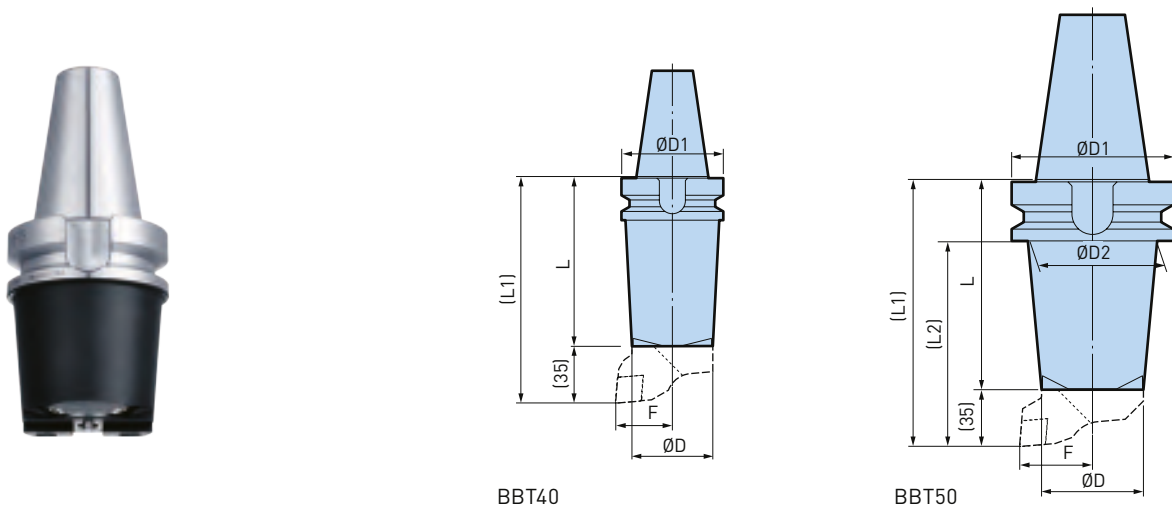

Model	Order No.	ØD	ØD1	ØD2	L	L1	L2	F
BBT40M-F50-75	800.157	50	63	-	75	110	-	35
BBT40M-F50-105	978.162	50	63	-	105	140	-	35
BBT50M-F63-70	800.322	63	100	80	70	105	67	45
BBT50M-F63-130	800.321	63	100	80	130	165	127	45

1. Cartridge clamping screw is included.
2. Hexagon wrench is required to clamp cartridge (not included).

BBT(M) Square Tool Holder (180°)

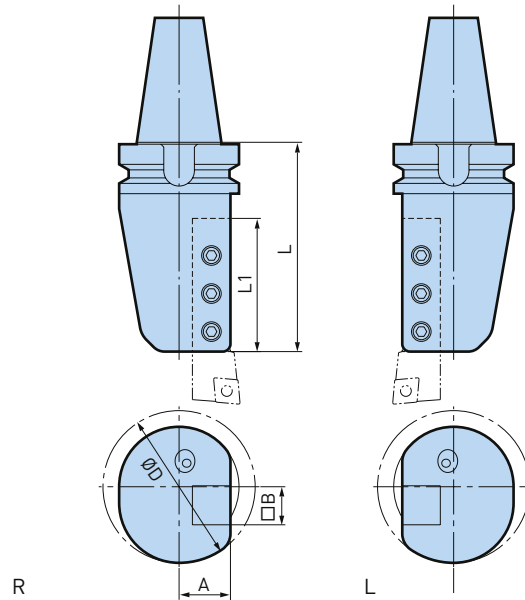

Model	Order No.	Hand	ØD	L	L1	A	B
BBT40M-180-BH20L-110	978.161	L	80	110	70	27	20
BBT40M-180-BH20R-110	800.153	R	80	110	70	27	20
BBT40M-180-BH25L-130	978.248	L	90	130	90	31,5	25
BBT40M-180-BH25R-130	978.285	R	90	130	90	31,5	25
BBT50M-180-BH25L-140	800.314	L	120	140	90	50	25
BBT50M-180-BH25R-140	978.407	R	120	140	90	50	25

A.7

BBT(M) Square Tool Holder Multi Type (180°)

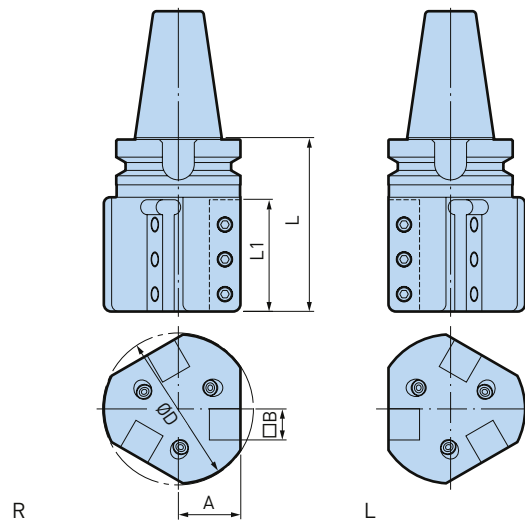

Model	Order No.	Hand	ØD	L	L1	A	B
BBT40M-180-3BH20L-110	800.151	L	90	110	70	35	20
BBT40M-180-3BH20R-110	800.152	R	90	110	70	38	20
BBT50M-180-3BH25L-140	800.312	L	120	140	90	50	25
BBT50M-180-3BH25R-140	800.313	R	120	140	90	50	25

BBT(M) Boring Bar Holder

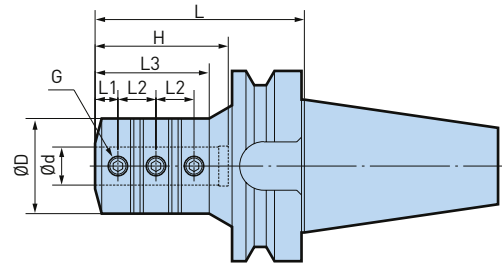

Model	Order No.	Ød	ØD	L	L1	L2	L3	H	G
BBT40M-BSL8-75	800.154	8	25	75	6	10	40	40	M6 P1.0
BBT40M-BSL10-80	978.292	10	29	80	8	12	45	50	M8 P1.0
BBT40M-BSL12-90	978.323	12	34	90	8	16	53	55	M8 P1.0
BBT40M-BSL16-100	978.293	16	40	100	10	21	65	68	M10 P1.24
BBT40M-BSL20-100	978.252	20	50	100	12	20	67	70	M10 P1.24
BBT40M-BSL25-110	978.319	25	55	110	14	23	83	74	M12 P1.5
BBT40M-BSL32-125	978.320	32	64	125	16	26	-	83	M12 P1.5
BBT40M-BSL40-150	978.321	40	80	150	18	32	-	98	M16 P1.5
BBT50M-BSL16-105	800.315	16	40	105	10	21	61	68	M10 P1.25
BBT50M-BSL20-110	800.316	20	50	110	12	20	60	70	M10 P1.25
BBT50M-BSL25-120	800.317	25	55	120	14	23	70	74	M12 P1.5
BBT50M-BSL32-125	800.318	32	64	125	16	26	80	83	M12 P1.5
BBT50M-BSL40-135	800.319	40	80	135	18	32	91	98	M16 P1.5
BBT50M-BSL50-145	800.320	50	90	145	18	36	102	115	M16 P1.5

A.7

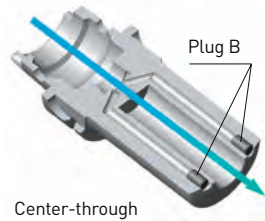
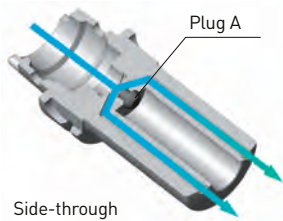

Interchangeable between center-through and side-through coolant supply by using plugs.

Adjustment for either right hand or left hand is also possible.

Chuck Model	Plug A	Plug B
BSL 6	M5 P0.8	M4 P0.7
BSL 8	M6 P1.0	
BSL 10		M5 P0.8
BSL 12		
BSL 16	M6 P1.0	M6 P1.0
BSL 20		
BSL 25	T63: M6 P1.0 T100: M8 P1.25	
BSL 32	M8 P1.25	
BSL 40		

1. Both plugs are included as standard.

Accessories & Spare Parts

Sleeve for Boring Bar Holders for BSL



► 355

45°

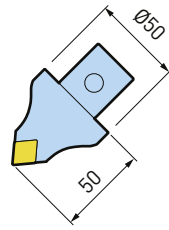

S50
Type S basic holder

- HSK-T 63- S50 - 60
- 75
- 100
- HSK-T100-S50 - 115

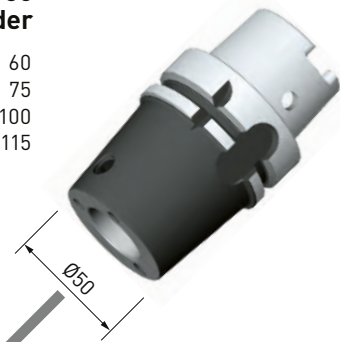

Type S cartridge

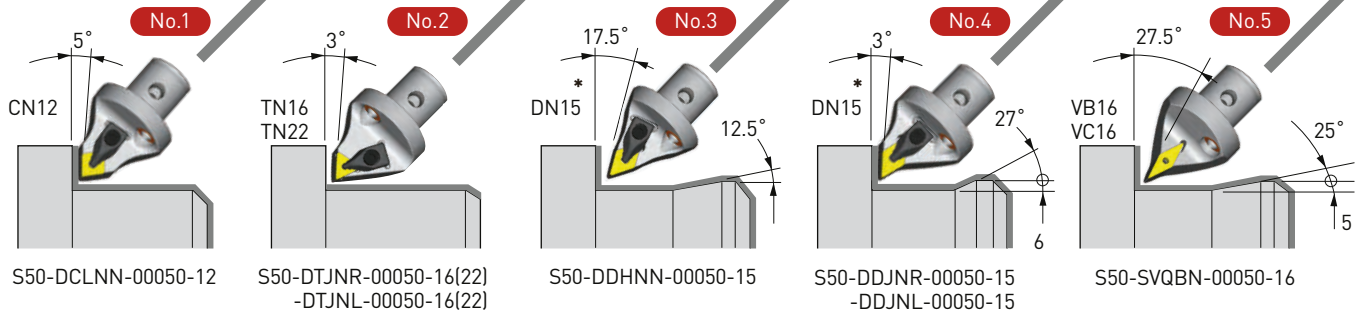

* In case of DN1506 insert (thickness of 6.35mm), please replace the standard Carbide Shim by DNS1506 (option).

A.7

90°

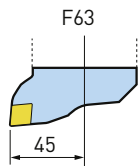

F63
Type F
basic holder

- HSK-T 63-F63
- HSK-T100-F63



S63
Type S
basic holder



Type S cartridge

- No.1
- No.3
- No.5
- No.8

Type F cartridge

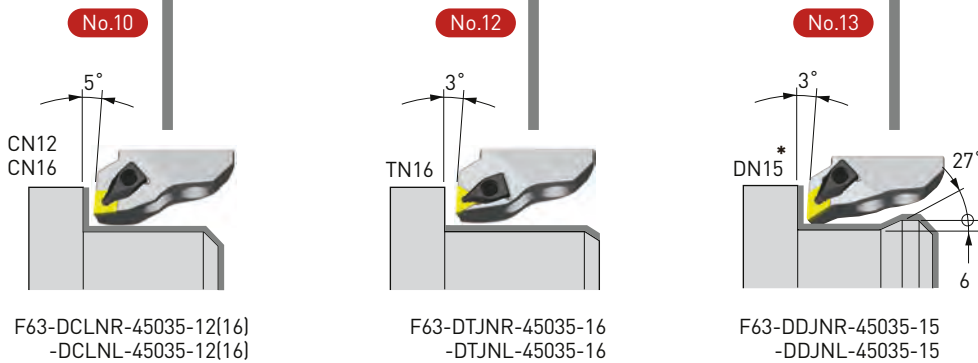

* In case of DN1506 insert (thickness of 6.35mm), please replace the standard Carbide Shim by DNS1506 (option).

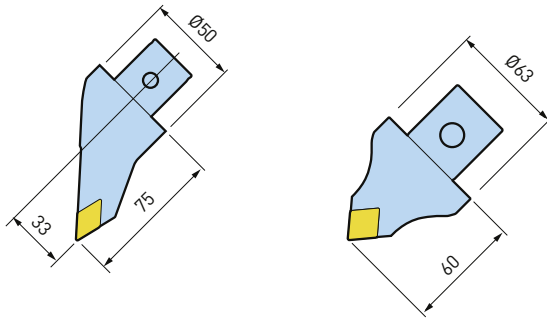

S63
Type S basic holder

HSK-T 63-S63- 70
- 90
HSK-T100-S63-105

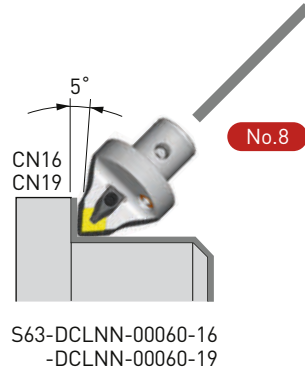
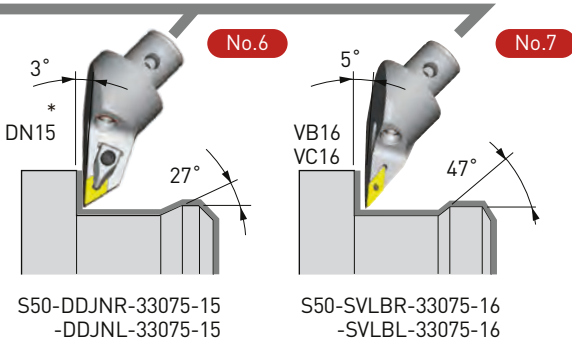
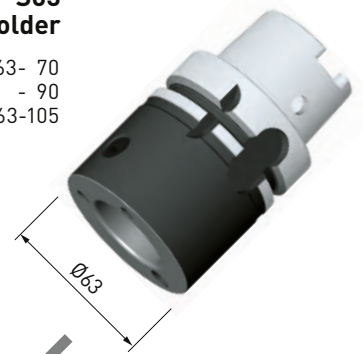

A.7

S50-DDJNR-33075-15
-DDJNL-33075-15

S50-SVLBR-33075-16
-SVLBL-33075-16

S63-DCLNN-00060-16
-DCLNN-00060-19

Boring bar holder



Square tool holder 180°

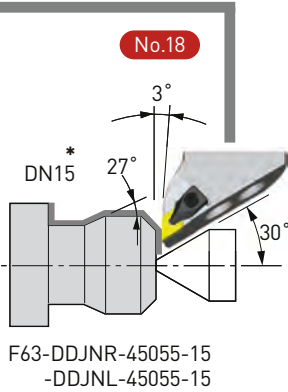
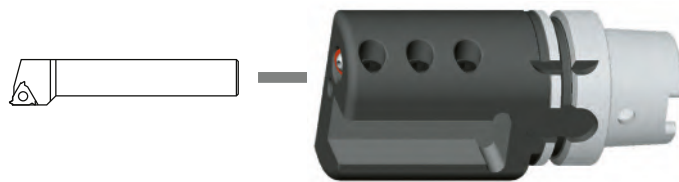

F63-DDJNR-45055-15
-DDJNL-45055-15

45° Basic Holders Type S

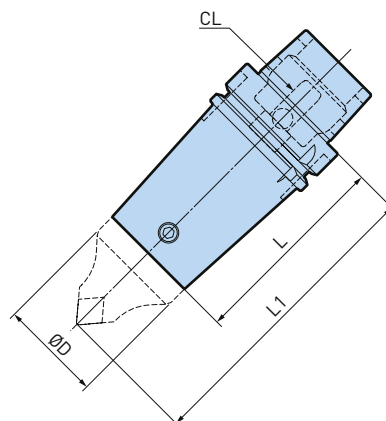
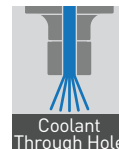

Model	Order No.	Type	ØD	L	L1	Clamp Screw
HSK-T50-S50-60	806.020	S50	50	60	110	CK5S
HSK-T63-S50-60	801.303	S50	50	60	110	CK5S
HSK-T63-S50-75	974.006	S50	50	75	125	CK5S
HSK-T63-S50-100	801.302	S50	50	100	150	CK5S
HSK-T63-S63-70	805.874	S63	63	70	130	CK6S
HSK-T63-S63-90	805.875	S63	63	90	150	CK6S
HSK-T100-S50-115	805.876	S50	50	115	165	CK5S
HSK-T100-S63-105	805.877	S63	63	105	165	CK6S

A.7

1. Basic holders include a clamp screw.
2. Coolant pipe (CL) is to be ordered separately.

Accessories & Spare Parts

45° Cartridges Type S	Coolant Pipes	Clamping screw Set
 <p>► 284</p>	 <p>► 228</p>	 <p>► 286</p>

90° Basic Holders Type F

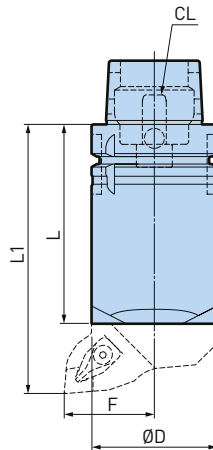
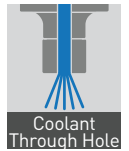

Fig. 1

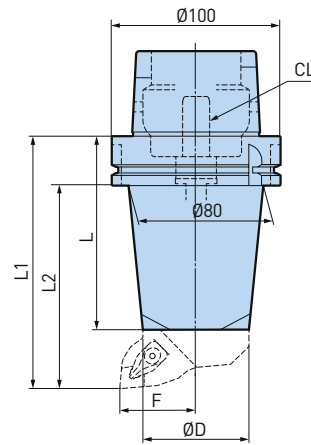



Fig. 2

Model	Order No.	Fig.	Type	ØD	L	L1	L2	F
HSK-T63-F63-50	801.301	1	F63	63	50	85	-	45
HSK-T63-F63-75	974.056	1	F63	63	75	110	-	45
HSK-T63-F63-100	974.057	1	F63	63	100	135	-	45
HSK-T63-F63-130	801.299	1	F63	63	130	165	-	45
HSK-T63-F63-170	801.300	1	F63	63	170	205	-	45
HSK-T100-F63-100	805.878	2	F63	63	100	135	105	45
HSK-T100-F63-150	805.879	2	F63	63	150	185	155	45

1. Basic holders include M10x22L and M10x25L screws for clamping cartridges.
2. Hexagon wrench is required to clamp cartridge (not included).
3. Coolant pipe (CL) is to be ordered separately.

A.7

Accessories & Spare Parts

<p>90° Cartridges Type F</p>  <p>► 285</p>	<p>Coolant Pipes</p>  <p>► 228</p>
---	---

Square Tool Holders - 45° Type

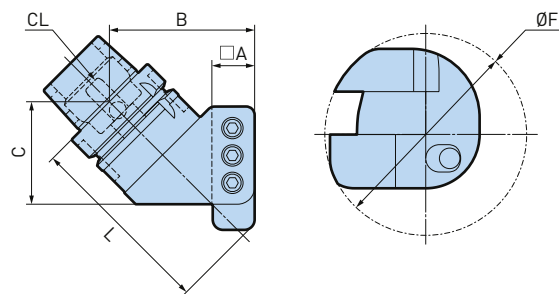
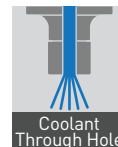

Model	Order No.	Hand	A	B	C	L	ØF
HSK-T63-45-BH25R-110	974.028	R	25	85	60	110	118
HSK-T63-45-BH25L-110	801.294	L	25	85	60	110	118

1. Coolant pipe (CL) is to be ordered separately.

A.7

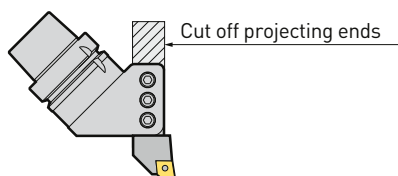

Caution

The projecting end of a turning tool must be cut off to avoid interference with an ATC arm.

Square Tool Holders - 90° Type

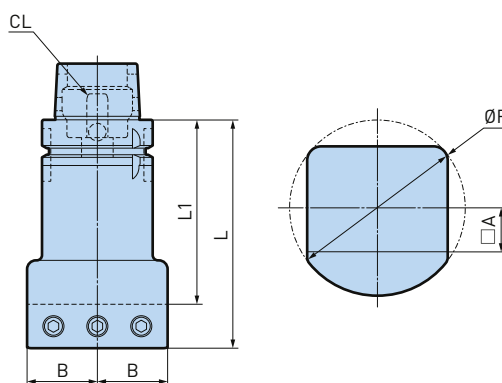
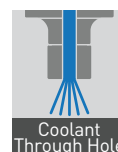

Model	Order No.	Hand	A	B	L	L1	ØF
HSK-T63-90-BH20N-85	806.246	N	20	32	85	65	80
HSK-T63-90-BH25N-100	801.296	N	25	40	100	75	100
HSK-T63-90-BH25N-130	801.297	N	25	40	130	105	100
HSK-T100-90-BH25N-150	805.537	N	25	55	150	125	128

1. Coolant pipe (CL) is to be ordered separately.

Accessories & Spare Parts

Coolant Pipes

► 228

Square Tool Holders - 180° Type

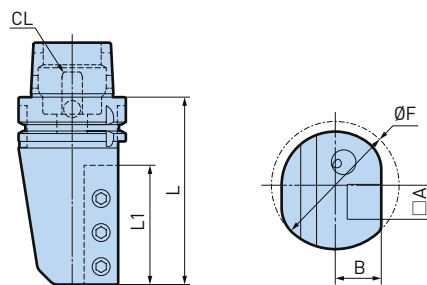
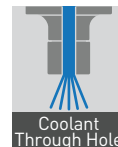

Model	Order No.	Hand	A	B	L	L1	ØF
HSK-T63-180-BH20R-120	806.248	R	20	27	120	70	75
HSK-T63-180-BH20L-120	806.247	L	20	27	120	70	75
HSK-T63-180-BH25R-125	806.250	R	25	29.5	127	80	90
HSK-T63-180-BH25L-125	806.249	L	25	29.5	127	80	90
HSK-T100-180-BH25R-140	805.306	R	25	50	140	90	120
HSK-T100-180-BH25L-140	805.305	L	25	50	140	90	120
HSK-T100-180-BH25R-180	805.536	R	25	50	180	90	120
HSK-T100-180-BH25L-180	805.535	L	25	50	180	90	120

1. Coolant pipe [CL] is to be ordered separately.

A.7

Square Tool Holders - 180° Multi Type

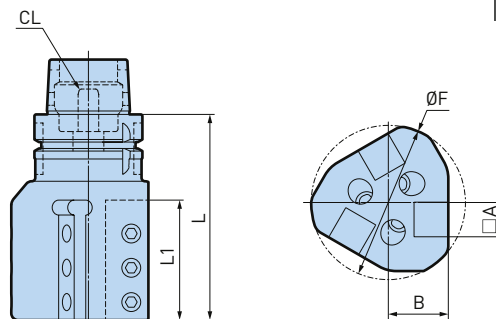
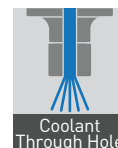

Model	Order No.	Hand	A	B	L	L1	ØF
HSK-T63-180-3BH20R-120	801.290	R	20	35	120	70	90
HSK-T63-180-3BH20L-120	801.289	L	20	35	120	70	90
HSK-T63-180-3BH25R-125	806.252	R	25	45	127	80	110
HSK-T63-180-3BH25L-125	806.255	L	25	45	127	80	110

- 1. 60° indexing is required to the machine tool spindle.
- 2. Coolant pipe [CL] is to be ordered separately.

Accessories & Spare Parts

Coolant Pipes

► 228

Boring Bar Holders

Application: boring and thread cutting

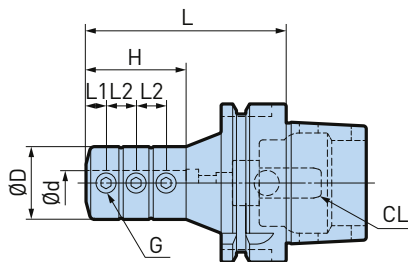
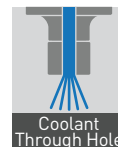

Fig. 1

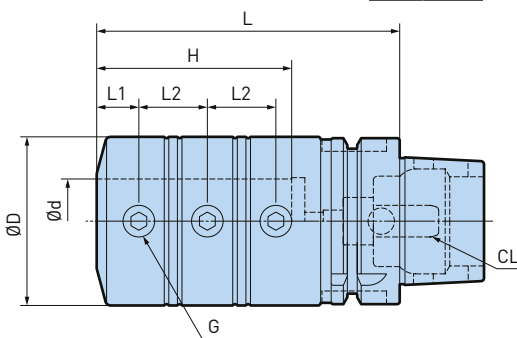
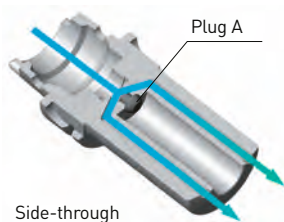

Fig. 2

ø6 - 40mm

Model	Order No.	Fig.	Ød	ØD	L	L1	L2	H	G
HSK-T63-BSL6-70	979.198	1	6	23	70	5	8	24	M5 P0.8
HSK-T63-BSL8-75	801.298	1	8	25	75	6	10	32	M6 P1.0
HSK-T63-BSL10-80	979.199	1	10	29	80	8	12	40	M8 P1.0
HSK-T63-BSL12-85	974.100	1	12	34	85	8	16	45	M8 P1.0
HSK-T63-BSL16-80	806.021	1	16	40	80	10	21	41	M10 P1.25
HSK-T63-BSL16-100	978.135	1	16	40	100	10	21	60	M10 P1.25
HSK-T63-BSL20-80 *	806.022	1	20	50	80	12	20	41	M10 P1.25
HSK-T63-BSL20-100	974.102	2	20	50	100	12	20	60	M10 P1.25
HSK-T63-BSL25-85	806.023	1	25	55	85	14	23	47	M12 P1.5
HSK-T63-BSL25-110	806.243	2	25	55	110	14	23	67	M12 P1.5
HSK-T63-BSL32-90 *	806.024	1	32	64	90	16	26	49	M12 P1.5
HSK-T63-BSL32-125	806.244	2	32	64	125	16	26	74	M12 P1.5
HSK-T63-BSL40-105	806.025	1	40	80	105	18	32	61	M16 P1.5
HSK-T63-BSL40-145	806.245	2	40	80	145	18	32	91	M16 P1.5
HSK-T63-BSL50-145	807.576	2	50	90	145	18	30	88	M16 P1.5
HSK-T100-BSL16-105	805.880	1	16	40	105	10	21	60	M10 P1.25
HSK-T100-BSL20-110	805.881	1	20	50	110	12	20	60	M10 P1.25
HSK-T100-BSL25-120	805.538	1	25	55	120	14	23	67	M12 P1.5
HSK-T100-BSL32-125	805.539	1	32	64	125	16	26	74	M12 P1.5
HSK-T100-BSL40-135	805.540	1	40	80	135	18	32	90	M16 P1.5
HSK-T100-BSL50-145	807.577	2	50	90	145	18	34	96	M16 P1.5

1. Coolant pipe (CL) is to be ordered separately.
2. For sealing purpose, please use plugs according to drawing below. Both, plug A and B are included as standard.
3. * Sleeve for BSL cannot be used.



Side-through

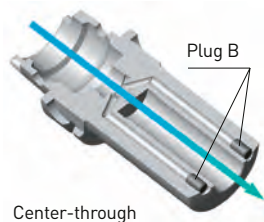

Center-through

Interchangeable between center-through and side-through coolant supply by using plugs.
Adjustment for either right hand or left hand is also possible.

Accessories & Spare Parts

<p>Sleeve for Boring Bar Holders for BSL</p> <p>▶ 355</p>	<p>Coolant Pipes</p> <p>▶ 228</p>
---	-----------------------------------

Chuck Model	Plug A	Plug B
BSL 6	M5 P0.8	M4 P0.7
BSL 8	M6 P1.0	
BSL 10		M6 P1.0
BSL 12	M6 P1.0	
BSL 16		
BSL 20		
BSL 25	T63: M6 P1.0 T100: M8 P1.25	
BSL 32	M8 P1.25	
BSL 40		

1. Both plugs are included as standard.

Smart Damper Turning Adapter

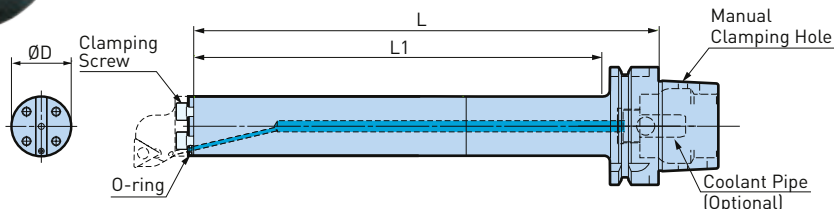
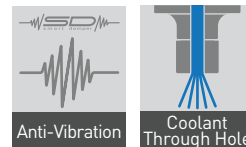

Model	Order No.	Cartridge	ØD	L	L1	Clamp Screw	O-Ring
HSK-T63-SDB40DP-172	101127.001.0	B32	32	172	145	C0510(M5x10L)	SDB20 OR-2P
HSK-T63-SDB40DP-250	101127.002.0	B32	32	250	219	C0510(M5x10L)	SDB20 OR-2P
HSK-T63-SDB50DP-235	101127.003.0	B40	40	235	204	C0610(M6x10L)	SDB20 OR-2P
HSK-T63-SDB50DP-315	101127.004.0	B40	40	315	284	C0610(M6x10L)	SDB20 OR-2P

1. Clamp bolts (3 pcs.) and o-rings (2 pcs.) are included.
2. Cartridge is to be ordered separately.
3. Coolant pipe (CL) and inserts are to be ordered separately.

A.7

Turning Adapter

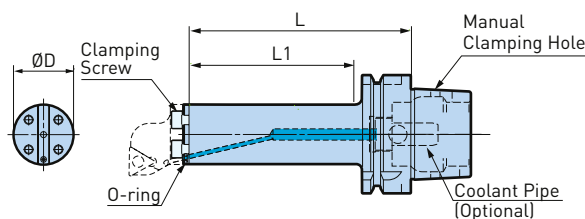
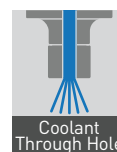

Model	Order No.	Cartridge	ØD	L	L1	Clamp Screw	O-Ring
HSK-T63-TAD40-125	101128.001.0	B32	32	125	94	C0510(M5x10L)	SDB20 OR-2P
HSK-T63-TAD50-155	101128.002.0	B40	40	155	124	C0610(M6x10L)	SDB20 OR-2P

1. Clamp bolts (3 pcs.) and o-rings (2 pcs.) are included.
2. Cartridge is to be ordered separately.
3. Coolant pipe (CL) and inserts are to be ordered separately.

Accessories & Spare Parts

Cartridges



► 316

S50
Type S basic holder

- C5-S50- 40
- 55
- 75
- C6-S50- 75
- 100
- C8-S50-135

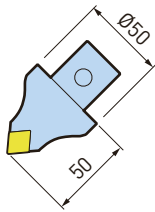
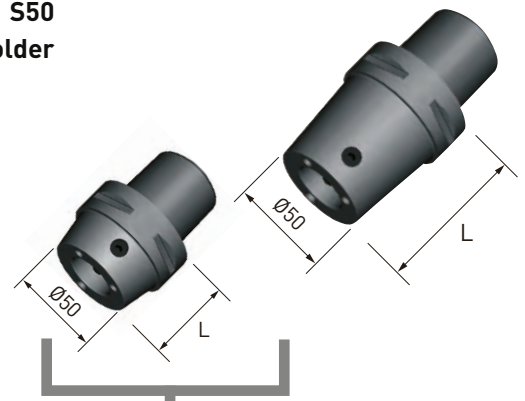

Type S cartridge

No.1

S50-DCLNN-00050-12

No.2

S50-DTJNR-00050-16
-DTJNL-00050-16
S50-DTJNR-00050-22
-DTJNL-00050-22

No.3

S50-DDHNN-00050-15

No.4

S50-DDJNR-00050-15
-DDJNL-00050-15

No.5

S50-SVQBN-00050-16

* In case of DN1506 insert (thickness of 6.35 mm), please replace the standard Carbide Shim by DNS1506 (option).

F50
Type F
basic holder

- C5-F50- 25
- 50
- 85
- 125

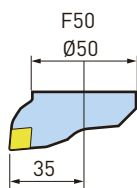

F63
Type F
basic holder

- C6-F63- 30
- 75
- 100
- 130
- 170
- C8-F63- 45
- 100
- 130
- 170

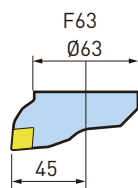

S50/S63
Type S
basic holder



Type S cartridge

- No.1
- No.3
- No.5
- No.8

Type F cartridge

No.10

F50-DCLNR-35035-12(16)
-DCLNL-35035-12(16)
F63-DCLNR-45035-12(16)
-DCLNL-45035-12(16)

No.12

F50-DTJNR-35035-16
-DTJNL-35035-16
F63-DTJNR-45035-16
-DTJNL-45035-16

No.13

F50-DDJNR-35035-15
-DDJNL-35035-15
F63-DDJNR-45035-15
-DDJNL-45035-15

* In case of DN1506 insert (thickness of 6.35 mm), please replace the standard Carbide Shim by DNS1506 (option).

S63
Type S basic holder

C6-S63- 90
C8-S63-125

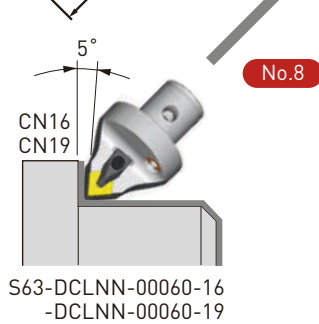
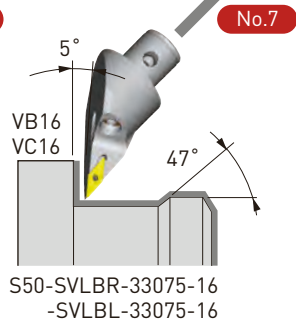
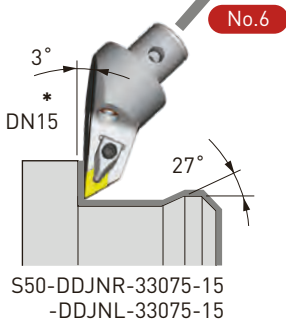
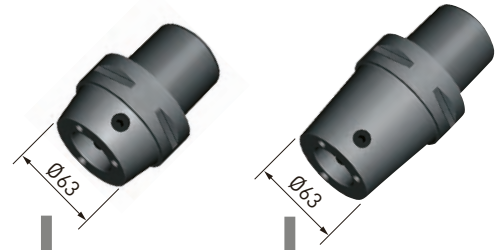
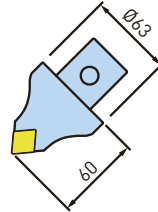
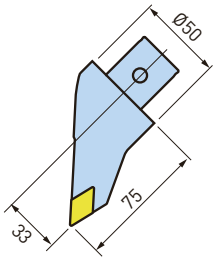

A.7

Square tool holder

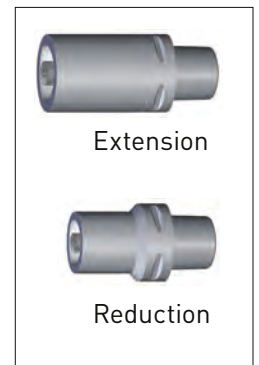
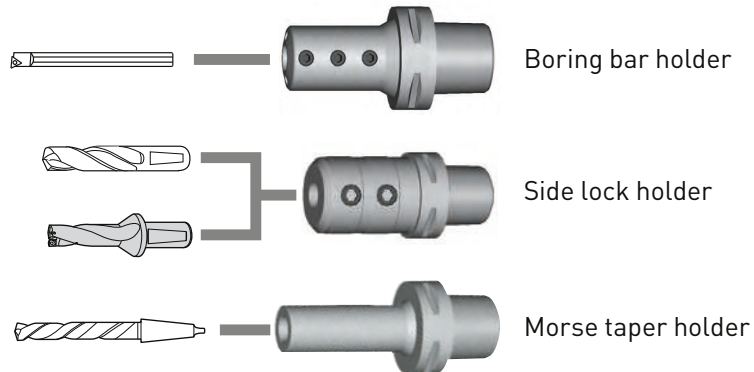
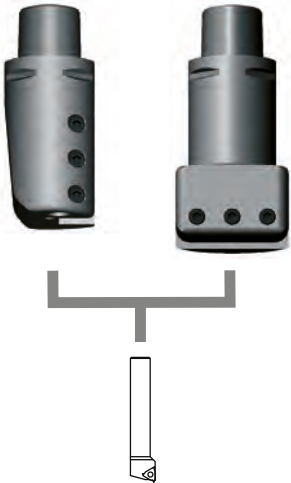

No.18

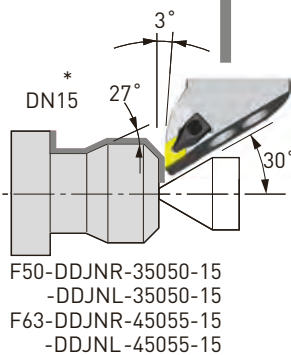

90° Integral Tool Holder Type F



45° Basic Holders Type S

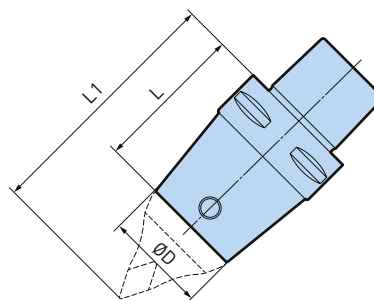
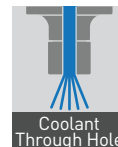

Model	Order No.	Type	ØD	L	L1	Clamp Screw
C5-S50-40	973.001	S50	50	40	90	CK5S
C5-S50-55	973.002	S50	50	55	105	CK5S
C5-S50-75	973.003	S50	50	75	125	CK5S
C6-S50-45	973.005	S50	50	45	95	CK5S
C6-S50-75	973.006	S50	50	75	125	CK5S
C6-S50-100	973.007	S50	50	100	150	CK5S
C6-S63-90	805.530	S63	63	90	150	CK6S
C8-S50-135	973.011	S50	50	135	185	CK5S
C8-S63-125	973.013	S63	63	125	185	CK6S

A.7

1. Basic holders include a clamp screw.

Clamping screw Set

Clamping screw Set- Type S



Model	Order No.	Type
CK5S	805.891	S50
CK6S	805.892	S63

1. 2 screws and 1 wrench are included

Accessories & Spare Parts

45° Cartridges Type S



► 284

45° Integral Tool Holder Type S

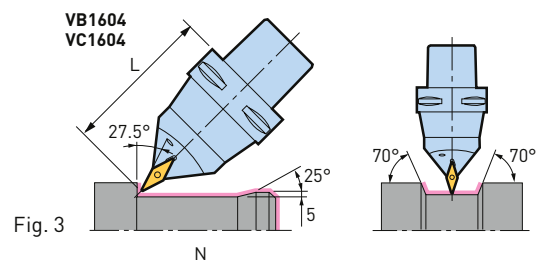
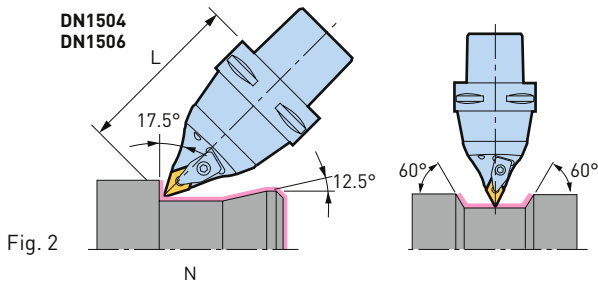
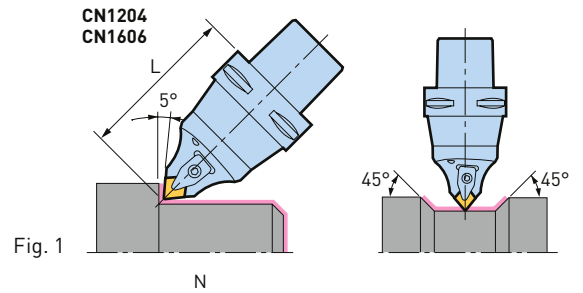

A.7

Model	Order No.	Fig.	Hand	L	Entering Angle	Insert	Clamp Piece	No.
C5-DCLNN-00105-12	800.691	1	N	105	95°	CN1204	CP2	1
C5-DDHNN-00105-15	800.693	2	N	105	107.5°	DN1504/DN1506*	CP2	3
C5-SVQBN-00105-16	800.774	3	N	105	117.5°	VB1604/VC1604**	M3.5	5
C5-DCLNN-00105-16	800.692	1	N	105	95°	CN1606	CP3	8-1
C6-DCLNN-00115-12	973.752	1	N	115	95°	CN1204	CP2	1
C6-DDHNN-00115-15	800.781	2	N	115	107.5°	DN1504/DN1506*	CP2	3
C6-SVQBN-00115-16	973.751	3	N	115	117.5°	VB1604/VC1604**	M3.5	5
C6-DCLNN-00115-16	800.780	1	N	115	95°	CN1606	CP3	8-1
C8-DCLNN-00150-12	800.890	1	N	150	95°	CN1204	CP2	1
C8-DCLNN-00150-16	800.891	1	N	150	95°	CN1606	CP3	8-1

1. Inserts are not included.
2. * Carbide shim for 4.76 mm thick DN1504 insert is included as standard. In case of DN1506 insert (thickness of 6.35 mm), please replace the standard carbide shim with DNS1506 (option).
3. ** VB1604 and VC1604 Inserts are suitable.
4. M3.5 is a screw-on type.

Accessories & Spare Parts

Spare parts for turning holders	Inserts CN	Inserts DN	Inserts VB	Inserts VC
 ▶ 286	 ▶ 492	 ▶ 493	 ▶ 494	 ▶ 494

90° Basic Holders Type F

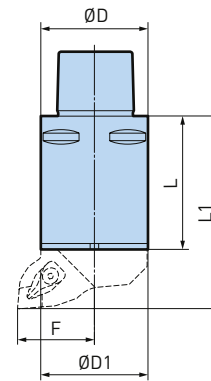

Model	Order No.	Type	ØD	ØD1	L	L1	F
C5-F50-25	801.657	F50	50	50	25	60	35
C5-F50-50	973.052	F50	50	50	50	85	35
C5-F50-85	973.053	F50	50	50	85	120	35
C5-F50-125	973.054	F50	50	50	125	160	35
C6-F63-30	973.055	F63	63	63	30	65	45
C6-F63-75	973.056	F63	63	63	75	110	45
C6-F63-100	973.057	F63	63	63	100	135	45
C6-F63-130	973.058	F63	63	63	130	165	45
C6-F63-170	973.059	F63	63	63	170	205	45
C8-F63-45	973.060	F63	80	63	45	80	45
C8-F63-100	973.061	F63	80	63	100	135	45
C8-F63-130	973.062	F63	80	63	130	165	45
C8-F63-170	973.063	F63	80	63	170	205	45

1. Basic holders include M10x22L and M10x25L screws for clamping cartridges.
2. Hexagon wrench is required to clamp cartridge (not included).

Accessories & Spare Parts

90° Cartridges
Type F



► 285

90° Integral Tool Holder Typ F

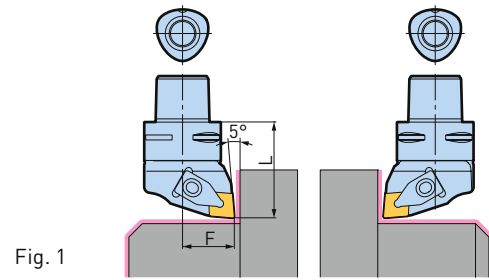
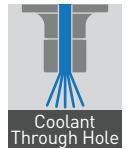

Fig. 1

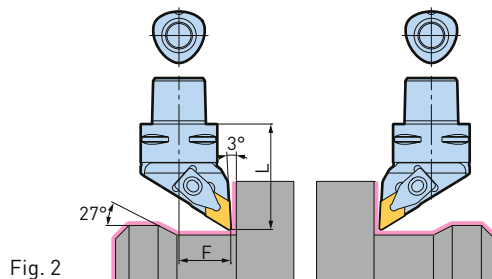

Fig. 2

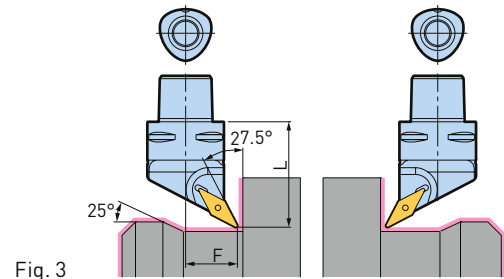



Fig. 3

A.7

Model	Order No.	Fig.	Hand	L	F	Entering Angle	Insert	Clamp Piece	No.
C3-DCLNL-22038-09	807.640	1	L	38	22	95°	CN0903 (CN0904)**	CP7	19
C3-DCLNR-22038-09	807.641	1	R	38	22	95°	CN0903 (CN0904)**	CP7	19
C3-DDJNL-22045-11	807.642	2	L	45	22	93°	DN1104	CP7	20
C3-DDJNR-22045-11	807.643	2	R	45	22	93°	DN1104	CP7	20
C3-SVQBL-22038-11	807.645	3	L	38	22	117.5°	VB1103 (VC1103)****	M2,5	21
C3-SVQBR-22038-11	807.644	3	R	38	22	117.5°	VB1103 (VC1103)****	M2,5	21
C4-DCLNL-27050-12	806.951	1	L	50	27	95°	CN1204	CP2	10 - 1
C4-DCLNR-27050-12	806.950	1	R	50	27	95°	CN1204	CP2	10 - 1
C4-DDJNL-27055-15	806.953	2	L	55	27	93°	DN1504 * (DN1506)	CP2	18
C4-DDJNR-27055-15	806.952	2	R	55	27	93°	DN1504 * (DN1506)	CP2	18
C4-SVQBL-27055-16	806.955	3	L	55	27	117.5°	VB1604 / VC1604 ***	M3.5	15
C4-SVQBR-27055-16	806.954	3	R	55	27	117.5°	VB1604 / VC1604 ***	M3.5	15

1. Inserts are not included.
2. Wrench is to be ordered separately.
3. * A carbide shim for 4.76 mm thick DN1504 insert is included.
When using DN1506 insert (thickness of 6.35 mm), replace the standard carbide shim with the CNS1506 (option).
4. ** A carbide shim for CN0903 (thickness: 3.18mm) is included.
When using a CN0904 insert (thickness: 4.75mm), replace the standard carbide shim with the CNS0904C (option).
5. *** VB1604 and VC1604 Inserts are suitable.
6. **** Either VB1103 or VC1103 insert are suitable.
7. M2.5 and M3.5 is a screw-on type.

Accessories & Spare Parts

Spare parts for turning holders	Inserts CN	Inserts DN	Inserts VB	Inserts VC
				
▶ 286	▶ 492	▶ 493	▶ 494	▶ 494

Square Tool Holders - 45° Type

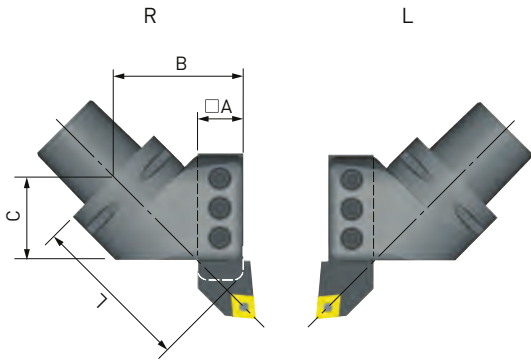

Model	Order No.	Hand	A	B	C	L	ØF
C5-45-BH20R-5838	973.026	R	20	58	38	73	94
C5-45-BH20L-5838	973.027	L	20	58	38	73	94
C6-45-BH25R-7752	973.028	R	25	77	52	100	118
C6-45-BH25L-7752	800.776	L	25	77	52	100	118
C8-45-BH32R-85109	973.030	R	32	85	109	145	135
C8-45-BH32L-85109	973.031	L	32	85	109	145	135

Caution

The projecting end of a turning tool must be cut off to avoid interference with an ATC arm.

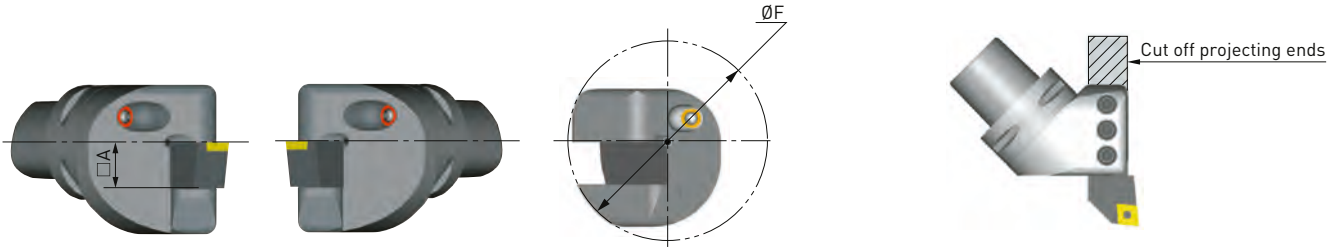

A.7

Square Tool Holders - 90° Type

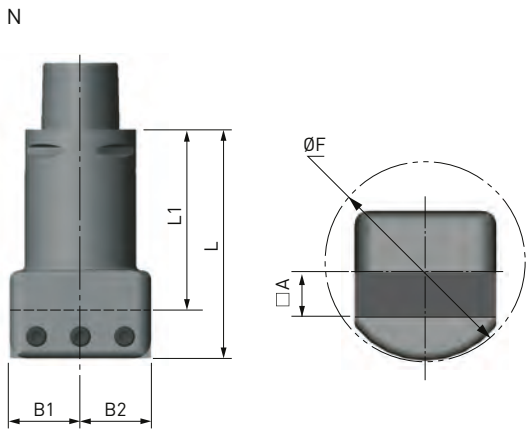

Model	Order No.	Hand	A	B1	B2	L	L1	L2	ØF
C3-90-BH16R-2547	807.647	R	16	25	27	47	30	40	70
C3-90-BH16L-2547	807.646	L	16	25	27	47	30	40	70
C4-90-BH20R-2854	806.956	R	20	28	32	54	34	45	80
C4-90-BH20L-2854	806.957	L	20	28	32	54	34	45	80
C5-90-BH20N-32058	978.476	N	20	32	32	58	38	-	80
C5-90-BH20N-32105	801.653	N	20	32	32	105	85	-	80
C6-90-BH20N-32060	800.777	N	20	32	32	60	40	-	80
C6-90-BH20N-32115	800.778	N	20	32	32	115	95	-	80
C6-90-BH25N-40071	800.779	N	25	40	40	71	46	-	100
C6-90-BH25N-40130	801.664	N	25	40	40	130	105	-	100
C8-90-BH25N-40071	328.380	N	25	40	40	71	45	-	100
C8-90-BH32N-51085	800.889	N	32	51	51	85	53	-	128
C8-90-BH32N-51165	801.665	N	32	51	51	165	133	-	128

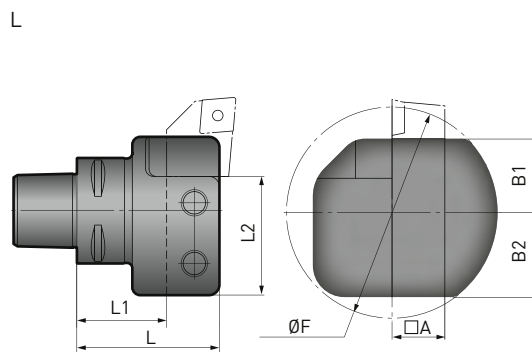
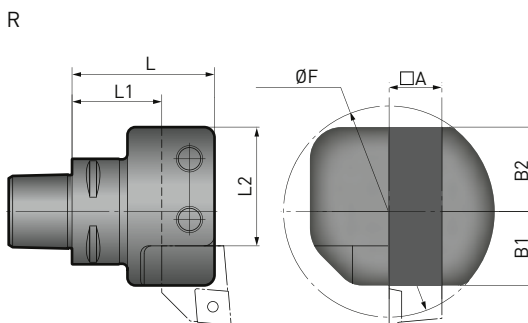

Square Tool Holders - 180° Type

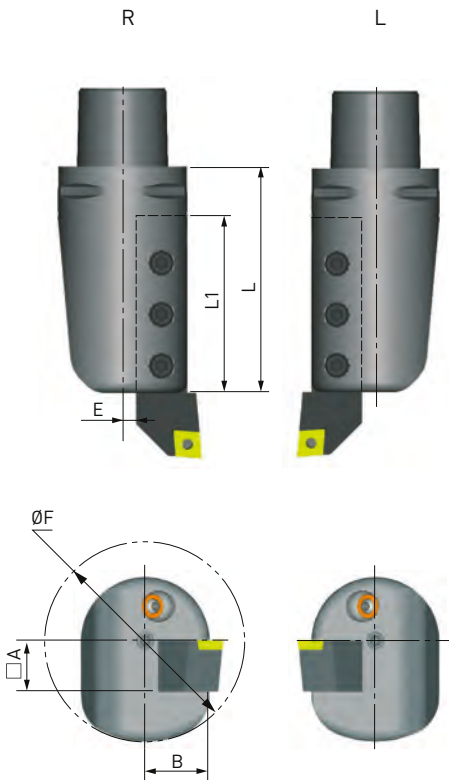
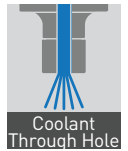

Model	Order No.	Hand	A	B	L	L1	E	ØF
C3-180-BH16R-2058	807.649	R	16	20	58	37	2	65
C3-180-BH16L-2058	807.648	L	16	20	58	37	2	65
C4-180-BH20R-2265	806.958	R	20	22	65	40	2	70
C4-180-BH20L-2265	806.959	L	20	22	65	40	2	70
C5-180-BH20R-2590	973.032	R	20	25	90	65	5	80
C5-180-BH20L-2590	973.033	L	20	25	90	65	5	80
C6-180-BH20R-32100	973.753	R	20	31.5	100	65	11.5	80
C6-180-BH20L-32100	801.663	L	20	31.5	100	65	11.5	80
C6-180-BH25R-32120S	973.034	R	25	29.5	120	80	4.5	90
C6-180-BH25L-32120S	973.035	L	25	29.5	120	80	4.5	90
C8-180-BH25R-32120	328.378	R	25	38	120	82	13	100
C8-180-BH25L-32120	328.379	L	25	38	120	82	13	100
C8-180-BH32R-40125	973.038	R	32	40	125	85	8	128
C8-180-BH32L-40125	973.039	L	32	40	125	85	8	128

A.7

Square Tool Holders - 180° Multi Type

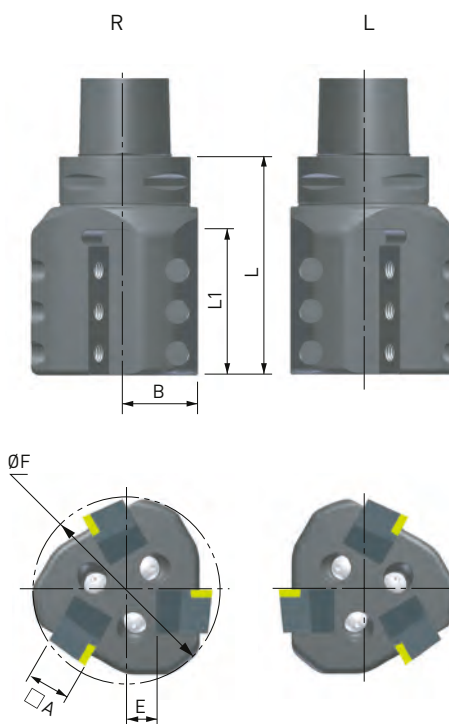
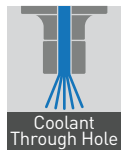

Model	Order No.	Hand	A	B	L	L1	E	ØF
C5-180-3BH20R-100	973.040	R	20	35	100	70	15	90
C5-180-3BH20L-100	973.041	L	20	35	100	70	15	90
C6-180-3BH20R-110	806.254	R	20	35	110	70	15	90
C6-180-3BH20L-110	806.253	L	20	35	110	70	15	90
C6-180-3BH25R-125	806.256	R	25	45	125	70	20	110
C6-180-3BH25L-125	973.045	L	25	45	125	80	20	110
C8-180-3BH25R-130	973.046	R	25	45	130	90	20	110
C8-180-3BH25L-130	973.047	L	25	45	130	70	20	110

1. 60° indexing is required to the machine tool spindle.

Boring Bar Holders

Application: boring and thread cutting



ø6 - 40mm

Model	Order No.	Fig.	Ød	ØD	L	A1	A2	H	G
C3-BSL6-35	807.663	1	6	23	35	5	9	22	M5 P0.8
C3-BSL8-35	807.664	1	8	25	35	6	10	22	M6 P1.0
C3-BSL10-35	807.665	1	10	29	35	6	10	22	M5 P0.8
C3-BSL12-40	807.666	1	12	34	40	8	12	27	M6 P1.0
C4-BSL6-40	806.960	1	6	23	40	5	9	23	M5 P0.8
C4-BSL8-40	806.961	1	8	25	40	6	10	23	M6 P1.0
C4-BSL10-40	806.962	1	10	29	40	6	10	23	M6 P1.0
C4-BSL12-45	806.963	1	12	34	45	8	12	28	M8 P1.0
C4-BSL16-50	806.964	1	16	40	50	10	14	33	M10 P1.25
C4-BSL20-60	806.965	1	20	50	60	12	15	43	M10 P1.25
C5-BSL6-70	973.088	2	6	23	70	5	8	41	M5 P0.8
C5-BSL8-70	973.089	2	8	25	70	6	10	41	M6 P1.0
C5-BSL10-70	973.090	2	10	29	70	8	12	42	M8 P1.0
C5-BSL12-80	973.091	2	12	34	80	8	16	53	M8 P1.0
C5-BSL16-90	973.092	2	16	40	90	10	21	65	M10 P1.25
C5-BSL20-90	973.093	2	20	50	90	12	20	60	M10 P1.25
C5-BSL25-100	973.094	2	25	55	100	14	23	70	M12 P1.5
C5-BSL32-110	973.095	2	32	64	110	16	26	78	M12 P1.5
C5-BSL40-130	973.096	2	40	80	130	18	32	93	M16 P1.5
C6-BSL6-70	973.097	2	6	23	70	5	8	41	M5 P0.8
C6-BSL8-70	973.098	2	8	25	70	6	10	41	M6 P1.0
C6-BSL10-70	973.099	2	10	29	70	8	12	42	M8 P1.0
C6-BSL12-80	973.100	2	12	34	80	8	16	53	M8 P1.0
C6-BSL16-90	973.101	2	16	40	90	10	21	65	M10 P1.25
C6-BSL20-90	973.102	2	20	50	90	12	22	60	M10 P1.25
C6-BSL25-100	973.103	2	25	55	100	14	26	70	M12 P1.5
C6-BSL32-110	973.104	2	32	64	110	16	30	78	M12 P1.5
C6-BSL40-130	973.105	2	40	80	130	18	32	93	M16 P1.5

A.7

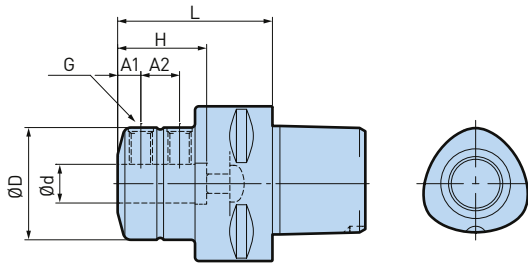

Fig. 1

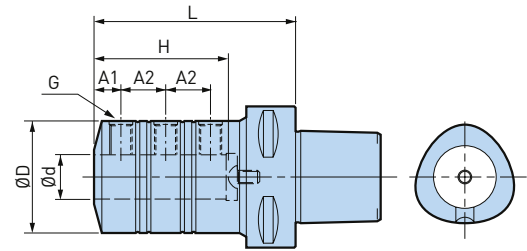
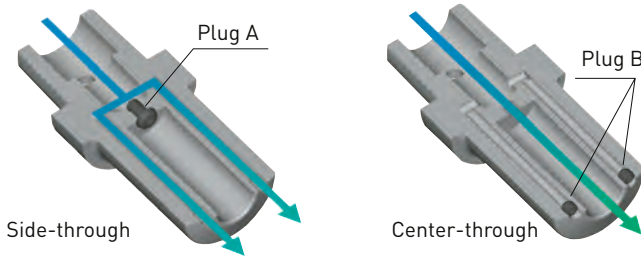

Fig. 2

Model	Order No.	Fig.	Ød	ØD	L	A1	A2	H	G
C8-BSL16-90	973.110	2	16	40	90	10	21	65	M10 P1.25
C8-BSL20-100	973.111	2	20	50	100	12	22	70	M10 P1.25
C8-BSL25-110	973.112	2	25	55	110	14	26	80	M12 P1.5
C8-BSL32-120	973.113	2	32	64	120	16	30	88	M12 P1.5
C8-BSL40-130	973.114	2	40	80	130	18	32	93	M16 P1.5

1. For sealing purpose, please use plugs according to drawing below. Both, plug A and B are included as standard.
2. Sleeve for BSL cannot be used for C3 and C4 models.



For C3

Chuck Model	Plug A	Plug B
BSL 6	M5 P0.8	M4 P0.7
BSL 8		
BSL 10		
BSL 12		

1. Both plugs are included as standard.

For C4

Chuck Model	Plug A	Plug B
BSL 6	M5 P0.8	M4 P0.7
BSL 8		M5 P0.8
BSL 10		M5 P0.8
BSL 12		M6 P1.0
BSL 16		M6 P1.0
BSL 20		M6 P1.0

1. Both plugs are included as standard.

For C5, C6 and C8

Chuck Model	Plug A	Plug B
BSL 6	M8P1.25	M4 P0.7
BSL 8	M10P1.0	
BSL 10	M12P1.5	M5 P0.8
BSL 12	M14P1.5	M6 P1.0
BSL 16	M18P1.5 (C5:M6P1.0)	
BSL 20	M6P1.0	
BSL 25	M6P1.0	
BSL 32	M8P1.25	
BSL 40	M8P1.25	

1. Both plugs are included as standard.

Accessories & Spare Parts

Sleeve for Boring Bar Holders for BSL

► 355

Smart Damper Turning Adapter

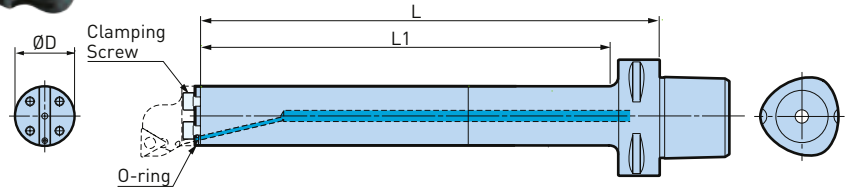
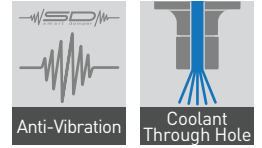

Model	Order No.	Cartridge	ØD	L	L1	Clamp Screw	O-Ring
C6-SDB40DP-168	101126.001.0	B32	32	168	145	C0510(M5x10L)	SDB20 OR-2P
C6-SDB40DP-245	101126.002.0	B32	32	245	218	C0510(M5x10L)	SDB20 OR-2P
C6-SDB50DP-230	101126.003.0	B40	40	230	203	C0610(M6x10L)	SDB20 OR-2P
C6-SDB50DP-310	101126.004.0	B40	40	310	283	C0610(M6x10L)	SDB20 OR-2P

A.7

1. Clamp bolts (3 pcs.) and o-rings (2 pcs.) are included.
2. Cartridge is to be ordered separately.
3. Inserts are not included.

Turning Adapter

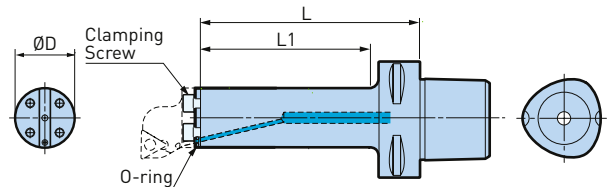

Model	Order No.	Cartridge	ØD	L	L1	Clamp Screw	O-Ring
C6-TAD40-120	101129.001.0	B32	40	120	93	C0510(M5x10L)	SDB20 OR-2P
C6-TAD50-150	101129.002.0	B40	50	150	123	C0610(M6x10L)	SDB20 OR-2P

1. Clamp bolts (3 pcs.) and o-rings (2 pcs.) are included.
2. Cartridge is to be ordered separately.
3. Inserts are not included.

Accessories & Spare Parts

Cartridges



▶ 316

New Baby Chuck Stopper

Flange as a stopper enables external presetting of the tool and minimizes downtime. Shank is designed to be directly mounted into the drill holder of turret.

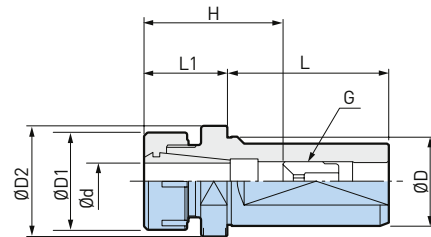

ø2.5 - 20mm

Model	Order No.	Ød	ØD	ØD1	ØD2	L	L1	H	Collet Model
SLS25-NBS13-30	804.285	2.5 - 13	25	35	32	54	30	41 - 60	NBC13
SLS25-NBS13-60	804.286	2.5 - 13	25	35	32	54	60	41 - 60	NBC13
SLS32-NBS13-30	804.288	2.5 - 13	32	35	39.5	58	30	41 - 60	NBC13
SLS32-NBS13-60	804.289	2.5 - 13	32	35	39.5	58	60	41 - 60	NBC13
SLS32-NBS13-100	804.287	2.5 - 13	32	35	39.5	58	100	41 - 60	NBC13
SLS32-NBS20-30	804.291	2.5 - 20	32	46	45.5	58	30	48 - 65	NBC20
SLS32-NBS20-60	804.292	2.5 - 20	32	46	45.5	58	60	48 - 65	NBC20
SLS32-NBS20-100	804.290	2.5 - 20	32	46	45.5	58	100	48 - 65	NBC20
SLS40-NBS13-30	804.294	2.5 - 13	40	35	49.5	68	30	41 - 60	NBC13
SLS40-NBS13-60	804.295	2.5 - 13	40	35	49.5	68	60	41 - 60	NBC13
SLS40-NBS13-100	804.293	2.5 - 13	40	35	49.5	68	100	41 - 60	NBC13
SLS40-NBS20-30	804.297	2.5 - 20	40	46	49.5	68	30	48 - 65	NBC20
SLS40-NBS20-60	804.298	2.5 - 20	40	46	49.5	68	60	48 - 65	NBC20
SLS40-NBS20-100	804.296	2.5 - 20	40	46	49.5	68	100	48 - 65	NBC20

1. New Baby Nut is included.
2. "G" is the adjusting screw (optional).
3. "H" is the max. tool shank length that can be inserted for these models.

Accessories & Spare Parts

New Baby Nuts	Baby Perfect Seals	New Baby Collets	New Baby Wrenches	Adjusting Screws NBA
				
▶ 334	▶ 338	▶ 327	▶ 352	▶ 335

New Baby Chuck Standard

Versatile basic holder for drills, taps and reamers.

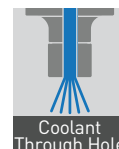

ø0.25 - 20mm

Model	Order No.	Fig.	Ød	ØD1	ØD2	ØD3	L	L1	H	Collet Model
SL16-NBS6-40	802.154	1	0.25 - 6	16	20	-	40	15	20 - 40	NBC6
SL16-NBS6-80	802.155	1	0.25 - 6	16	20	-	80	15	20 - 40	NBC6
SL16-NBS8-40	802.156	1	0.5 - 8	16	25	-	40	16.5	23 - 42	NBC8
SL16-NBS8-80	802.157	1	0.5 - 8	16	25	-	80	16.5	23 - 42	NBC8
SL16-NBS10-40	802.152	2	1.5 - 10	16	30	21	40	37	35 - 45	NBC10
SL16-NBS10-80	802.153	2	1.5 - 10	16	30	21	80	37	35 - 45	NBC10
SL20-NBS6-40	802.162	1	0.25 - 6	20	20	-	40	15	20 - 40	NBC6
SL20-NBS6-80	802.163	1	0.25 - 6	20	20	-	80	15	20 - 40	NBC6
SL20-NBS8-40	802.164	1	0.5 - 8	20	25	-	40	16.5	23 - 42	NBC8
SL20-NBS8-80	802.165	1	0.5 - 8	20	25	-	80	16.5	23 - 42	NBC8
SL20-NBS10-40	802.158	2	1.5 - 10	20	30	21	40	18	35 - 45	NBC10
SL20-NBS10-80	802.159	2	1.5 - 10	20	30	21	80	18	35 - 45	NBC10
SL20-NBS13-40	802.160	2	2.5 - 13	20	35	26	40	43	41 - 60	NBC13
SL20-NBS13-80	802.161	2	2.5 - 13	20	35	26	80	43	41 - 60	NBC13
SL22-NBS6-40	804.271	1	0.25 - 6	22	20	-	40	15	20 - 40	NBC6
SL22-NBS6-80	804.272	1	0.25 - 6	22	20	-	80	15	20 - 40	NBC6
SL22-NBS8-40	804.273	1	0.5 - 8	22	25	-	40	16.5	23 - 42	NBC8
SL22-NBS8-80	804.274	1	0.5 - 8	22	25	-	80	16.5	23 - 42	NBC8
SL22-NBS10-40	804.267	1	1.5 - 10	22	30	-	40	18	35 - 45	NBC10
SL22-NBS10-80	804.268	1	1.5 - 10	22	30	-	80	18	35 - 45	NBC10
SL22-NBS13-40	804.269	2	2.5 - 13	22	35	26	40	21.5	41 - 47	NBC13
SL22-NBS13-80	804.270	2	2.5 - 13	22	35	26	80	21.5	41 - 60	NBC13

A.7

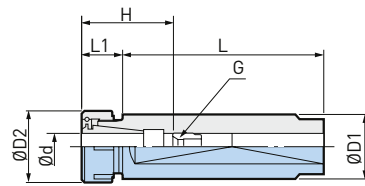

Fig. 1

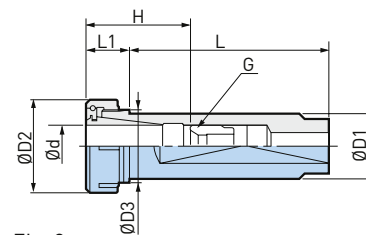

Fig. 2

Model	Order No.	Fig.	Ød	ØD1	ØD2	ØD3	L	L1	H	Collet Model
SL25-NBS6-80	802.173	1	0.25 - 6	25	20	-	80	15	20 - 40	NBC6
SL25-NBS6-120	802.172	1	0.25 - 6	25	20	-	120	15	20 - 40	NBC6
SL25-NBS8-80	802.175	1	0.5 - 8	25	25	-	80	16.5	23 - 42	NBC8
SL25-NBS8-120	802.174	1	0.5 - 8	25	25	-	120	16.5	23 - 42	NBC8
SL25-NBS10-80	802.167	1	1.5 - 10	25	30	-	80	18	35 - 45	NBC10
SL25-NBS10-120	802.166	1	1.5 - 10	25	30	-	120	18	35 - 45	NBC10
SL25-NBS13-80	802.169	2	2.5 - 13	25	35	26	80	21.5	41 - 60	NBC13
SL25-NBS13-120	802.168	2	2.5 - 13	25	35	26	120	21.5	41 - 60	NBC13
SL25-NBS16-80	802.171	2	2.5 - 16	25	42	32	80	48	45 - 65	NBC16
SL25-NBS16-120	802.170	2	2.5 - 16	25	42	32	120	48	45 - 65	NBC16
SL25.4-NBS6-80	804.282	1	0.25 - 6	25.4	20	-	80	15	20 - 40	NBC6
SL25.4-NBS6-120	804.281	1	0.25 - 6	25.4	20	-	120	15	20 - 40	NBC6
SL25.4-NBS8-80	804.284	1	0.5 - 8	25.4	25	-	80	16.5	23 - 42	NBC8
SL25.4-NBS8-120	804.283	1	0.5 - 8	25.4	25	-	120	16.5	23 - 42	NBC8
SL25.4-NBS10-80	804.276	1	1.5 - 10	25.4	30	-	80	18	35 - 45	NBC10
SL25.4-NBS10-120	804.275	1	1.5 - 10	25.4	30	-	120	18	35 - 45	NBC10
SL25.4-NBS13-80	804.278	2	2.5 - 13	25.4	35	26	80	21.5	41 - 50	NBC13
SL25.4-NBS13-120	804.277	2	2.5 - 13	25.4	35	26	120	21.5	41 - 50	NBC13
SL25.4-NBS16-80	804.280	2	2.5 - 16	25.4	42	32	80	48	45 - 65	NBC16
SL25.4-NBS16-120	804.279	2	2.5 - 16	25.4	42	32	120	48	45 - 65	NBC16
SL32-NBS13-100	802.176	1	2.5 - 13	32	35	-	100	21.5	41 - 60	NBC13
SL32-NBS13-150	802.177	1	2.5 - 13	32	35	-	150	21.5	41 - 60	NBC13
SL32-NBS16-100	802.178	1	2.5 - 16	32	42	-	100	21.5	45 - 65	NBC16
SL32-NBS16-150	802.179	1	2.5 - 16	32	42	-	150	21.5	45 - 65	NBC16
SL32-NBS20-100	802.180	2	2.5 - 20	32	46	36	100	21.5	48 - 65	NBC20
SL32-NBS20-150	802.181	2	2.5 - 20	32	46	36	150	21.5	48 - 65	NBC20

A.7

1. New Baby Nut is included.
2. "G" is the adjusting screw (optional).
3. "H" is the max. tool shank length that can be inserted for these models.

Accessories & Spare Parts

<p>New Baby Nuts</p> <p>▶ 334</p>	<p>Baby Perfect Seals</p> <p>▶ 338</p>	<p>New Baby Collets</p> <p>▶ 327</p>	<p>New Baby Wrenches</p> <p>▶ 352</p>	<p>Adjusting Screws NBA</p> <p>▶ 335</p>
--	---	---	--	---

MEGA ER Grip Stopper

High precision components outperform standard ER collet system.

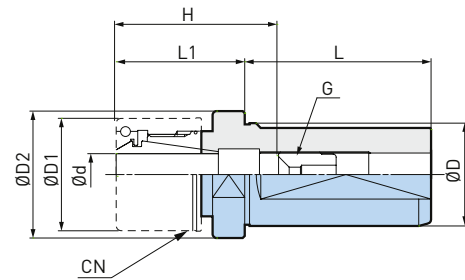
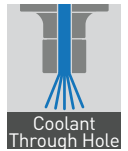

ø2.75 - 20mm

Model	Order No.	$\varnothing d$	$\varnothing D$	$\varnothing D1$	$\varnothing D2$	L	L1	H	Collet Model
SLS25-MEGAER20-45NL	803.571	2.75 - 13	25	35	32	54	45	42 - 62	ERC20
SLS25-MEGAER20-75NL	803.572	2.75 - 13	25	35	32	54	75	42 - 62	ERC20
SLS32-MEGAER20-45NL	803.573	2.75 - 13	32	35	39.5	58	45	42 - 62	ERC20
SLS32-MEGAER20-75NL	803.574	2.75 - 13	32	35	39.5	58	75	42 - 62	ERC20
SLS32-MEGAER32-45NL	803.575	2.75 - 20	32	50	50	58	45	47 - 68	ERC32
SLS32-MEGAER32-75NL	803.576	2.75 - 20	32	50	50	58	75	50 - 68	ERC32
SLS40-MEGAER20-45NL	803.577	2.75 - 13	40	35	49.5	68	45	42 - 62	ERC20
SLS40-MEGAER20-75NL	803.578	2.75 - 13	40	35	49.5	68	75	42 - 62	ERC20
SLS40-MEGAER32-45NL	803.579	2.75 - 20	40	50	50	68	45	50 - 68	ERC32
SLS40-MEGAER32-75NL	803.580	2.75 - 20	40	50	50	68	75	50 - 68	ERC32

1. Nut [CN] is not included.
2. "G" is the adjusting screw (optional).
3. "H" is the max. tool shank length that can be inserted for these models.

A.7

Accessories & Spare Parts

<p>MEGA ER Nut</p> <p>▶ 344</p>	<p>ER Nuts</p> <p>▶ 344</p>	<p>MEGA ER Perfect Seal</p> <p>▶ 345</p>	<p>MEGA ER Collets</p> <p>▶ 342</p>	<p>MEGA Wrenches</p> <p>▶ 351</p>	<p>New Baby Wrenches</p> <p>▶ 352</p>	<p>Adjusting Screws NBA</p> <p>▶ 335</p>
---------------------------------	-----------------------------	--	-------------------------------------	-----------------------------------	---------------------------------------	--

MEGA ER Grip Standard

Flat is provided on the shank to be mounted in the tool post of the NC lathe directly.

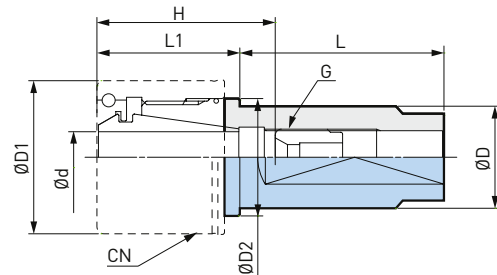

ø1.9 - 16mm

Model	Order No.	Ød	ØD	ØD1	ØD2	L	L1	H	Collet Model
SL16-MEGAER11-40NL	803.554	2.75 - 6	16	19	-	40	19	23 - 40	ERC11
SL16-MEGAER11-80NL	803.555	2.75 - 6	16	19	-	80	19	23 - 40	ERC11
SL19.05-MEGAER11-40NL	803.556	2.75 - 6	19.05	19	-	40	19	23 - 40	ERC11
SL19.05-MEGAER11-80NL	803.557	2.75 - 6	19.05	19	-	80	19	23 - 40	ERC11
SL19.05-MEGAER16-40NL	803.558	1.9 - 10	19.05	30	23	40	28	35 - 47	ERC16
SL19.05-MEGAER16-80NL	803.559	1.9 - 10	19.05	30	23	80	28	35 - 47	ERC16
SL20-MEGAER11-40NL	803.560	2.75 - 6	20	19	-	40	19	23 - 40	ERC11
SL20-MEGAER11-80NL	803.561	2.75 - 6	20	20	-	80	19	23 - 40	ERC11
SL20-MEGAER16-40NL	801.714	1.9 - 10	20	30	23	40	28	35 - 47	ERC16
SL20-MEGAER16-80NL	803.562	1.9 - 10	20	30	23	80	28	35 - 47	ERC16
SL25-MEGAER11-60NL	803.564	2.75 - 6	25	19	-	60	19	23 - 40	ERC11
SL25-MEGAER11-100NL	803.563	2.75 - 6	25	19	-	100	19	23 - 40	ERC11
SL25-MEGAER16-60NL	803.566	1.9 - 10	25	30	-	60	28	35 - 47	ERC16
SL25-MEGAER16-100NL	803.565	1.9 - 10	25	30	-	100	28	35 - 47	ERC16
SL25-MEGAER20-60NL	803.568	2.75 - 13	25	35	27	60	30	42 - 62	ERC20
SL25-MEGAER20-100NL	803.567	2.75 - 13	25	35	27	100	30	42 - 62	ERC20
SL25-MEGAER25-60NL	803.570	2.75 - 16	25	42	33.5	60	48	44 - 67	ERC25
SL25-MEGAER25-100NL	803.569	2.75 - 16	25	42	33.5	100	48	44 - 67	ERC25

1. Nut (CN) is not included.
2. "G" is the adjusting screw (optional).
3. "H" is the max. tool shank length that can be inserted for these models.

A.7

Accessories & Spare Parts

<p>MEGA ER Nut</p> <p>▶ 344</p>	<p>ER Nuts</p> <p>▶ 344</p>	<p>MEGA ER Perfect Seal</p> <p>▶ 345</p>	<p>MEGA ER Collets</p> <p>▶ 342</p>	<p>MEGA Wrenches</p> <p>▶ 351</p>	<p>New Baby Wrenches</p> <p>▶ 352</p>	<p>Adjusting Screws NBA</p> <p>▶ 335</p>
--	------------------------------------	---	--	--	--	---

MEGA Micro Chuck

Smaller nut diameter than body allows installation into toolholder of small lathes from the back side.

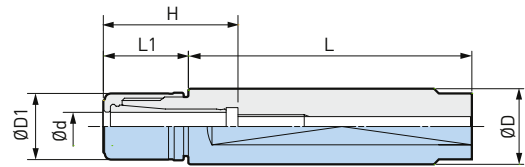
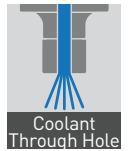

Ø0.45 - 8.05mm

Model	Order No.	Ød	ØD	ØD1	L	L1	H	Collet Model
SL15.875-MEGA6S-60	803.593	0.45 - 6.05	15.875	14	60	18	28.5	NBC6S
SL16-MEGA6S-60	803.594	0.45 - 6.05	16	14	60	18	28.5	NBC6S
SL19.05-MEGA6S-40	100570.001.0	0.45 - 6.05	19.05	14	40	18	28.5	NBC6S
SL19.05-MEGA6S-80	807.710	0.45 - 6.05	19.05	14	80	18	28.5	NBC6S
SL19.05-MEGA8S-40	807.410	2.95 - 8.05	19.05	18	40	19	31	NBC8S
SL19.05-MEGA8S-80	807.411	2.95 - 8.05	19.05	18	80	19	31	NBC8S
SL20-MEGA6S-40	803.595	0.45 - 6.05	20	14	40	18	28.5	NBC6S
SL20-MEGA6S-80	803.602	0.45 - 6.05	20	14	80	18	28.5	NBC6S
SL20-MEGA8S-40	807.412	2.95 - 8.05	20	18	40	19	31	NBC8S
SL20-MEGA8S-80	807.413	2.95 - 8.05	20	18	80	19	31	NBC8S

1. MEGA nut is included in delivery.
2. MEGA wrench is to be ordered separately.

Accessories & Spare Parts

MEGA Nuts	Micro Seal Nuts	Micro Collets	MEGA Wrenches
			
▶ 326	▶ 326	▶ 324	▶ 351

MEGA Synchro Tapping Holder

For small Tap MGT3

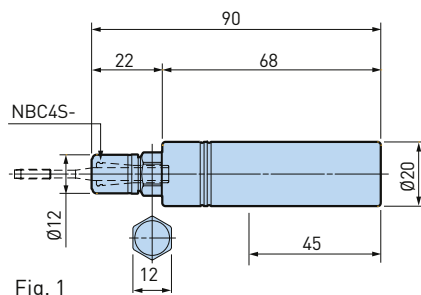

Fig. 1

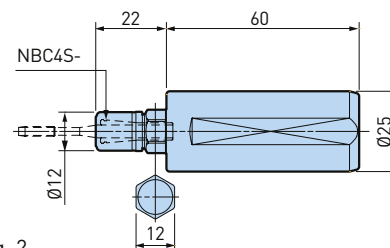

Fig. 2

Model	Order No.	Fig.
ST20-MGT3-90	978.356	1
SLS25-MGT3-22	804.115	2

1. MEGA nut is included in delivery.
2. MEGA wrench (MGR12) and common spanner (12 mm) are required to clamp/unclamp the tap.
3. 12 mm wrench is additionally required to clamp/release the tool.
4. Synchronized tapping function is required on the machine.
5. Coolant-through hole is not available.
6. ST20 has no flat on the shank.

A.7

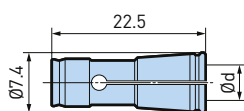

Micro Collet for MGT3



Model	Order No.	Tapping Range			Tap Shank
		DIN 371	ISO 529	JIS	Ød
NBC4S-2.5AA	961.468	M1 - M1.8	M2	-	2.5
-2.8AA	968.353	M2 - M2.6	M2.2, M2.5	-	2.8
-3.0AA	961.470	-	-	M1 - M2.6	3.0
-3.1AA	968.355	-	M3	-	3.15
-3.5AA	961.472	M3	-	-	3.5
-4.0AA	961.474	-	-	M3	4.0

1. Other sizes available. Please refer to micro collet.

Accessories & Spare Parts

<p>Micro Collets</p>  <p>▶ 324</p>	<p>MEGA Wrenches</p>  <p>▶ 351</p>
---	---

Smart Damper Turning

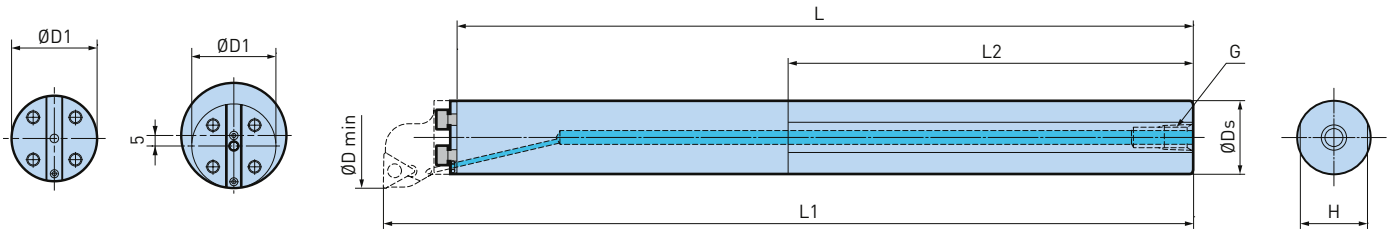
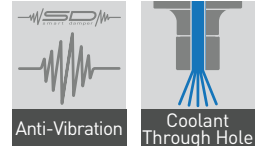

A.7

Fig. 1 Fig. 2

Model	Order No.	Fig.	Cartridge	ØD	ØDs	ØD1	L	L1	L2	H	G
ST32-SDB40DP-320	806.422	1	B32	40	32	32	320	352	176	30	PT1/4
ST40-SDB50DP-410	806.423	1	B40	50	40	40	410	442	240	37	PT3/8
ST50-SDB60DP-520	807.403	2	B40	60	50	40	520	552	330	47	PT3/8

1. Clamp bolts (3 pcs.) and o-rings (2 pcs.) are included.
2. Cartridge is to be ordered separately.

Cartridges

Positive

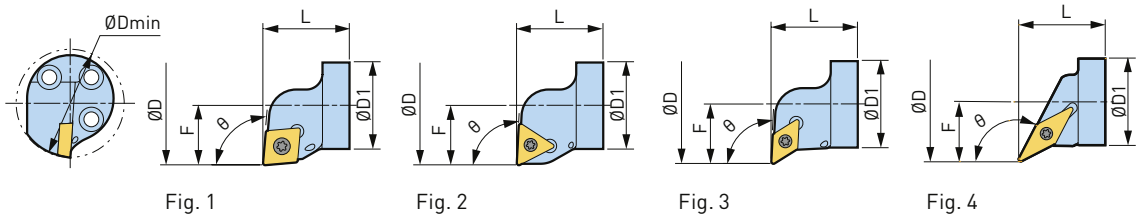

Model	Order No.	Fig.	Type	Insert	Hand	ØD	ØD1	L	F	Entering Angle	Screw Set
B32-STUCR-22032-11	806.802	2	B32	TC1102	R	40	32	32	22	93°	S2.5S- 7IP
B32-SDUCR-22032-11	806.426	3	B32	DC11T3	R	40	32	32	22	93°	S4 S-15IP
B32-SCLCR-22032-12	806.424	1	B32	CC1204	R	40	32	32	22	95°	S5 S-20IP
B32-STUPR-22032-16	806.425	2	B32	TP1604	R	40	32	32	22	93°	S4 S-15IP
B32-SVPBR-22032-16	807.406	4	B32	VB1604	R	40	32	32	22	117.5°	S3.5S-15IP
B40-STUCR-27032-11	806.803	2	B40	TC1102	R	50	40	32	27	93°	S2.5S- 7IP
B40-SDUCR-27032-11	806.429	3	B40	DC11T3	R	50	40	32	27	93°	S4 S-15IP
B40-SCLCR-27032-12	806.427	1	B40	CC1204	R	50	40	32	27	95°	S5 S-20IP
B40-STUPR-27032-16	806.428	2	B40	TP1604	R	50	40	32	27	93°	S4 S-15IP
B40-SVPBR-27032-16	807.409	4	B40	VB1604	R	50	40	32	27	117.5°	S3.5S-15IP

Negative

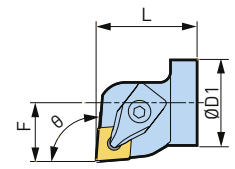
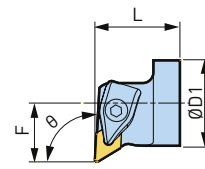
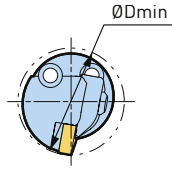

Fig. 1

Fig. 2

Model	Order No.	Fig.	Type	Insert	Hand	ØD	ØD1	L	F	Entering Angle
B32-DDUNR-22032-11	807.404	1	B32	DN1104	R	40	32	32	22	93°
B32-DCLNR-22038-12	807.405	2	B32	CN1204	R	40	32	38	22	95°
B40-DDUNR-27032-15	807.407	1	B40	DN1506*/ DN1504	R	50	40	32	27	93°
B40-DCLNR-27038-12	807.408	2	B40	CN1204	R	50	40	38	27	95°

1. Wrench is included.
2. Inserts are to be ordered separately.
3. * Carbide shim for 6.35 mm thick DN1506 insert is included as standard. In case of DN1504 insert (thickness of 4.76 mm), please replace the standard carbide shim with DNS1506 (option).

Spare Parts for Turning Cartridges

Insert Clamping Screw Set (for Positive)

Set Model	Order No.	Screw	Wrench Model
S2.5S- 7IP	100763.001.0	M2.5× 6.5	FS- 7IP
S3.5S-15IP	807.697	M3.5× 8	FS-15IP
S4 S-15IP	806.624	M4 × 8	FS-15IP
S5 S-20IP	100763.002.0	M5 ×12	FS-20IP

1. The insert clamping screw set contains 10 screws and 1 wrench.

Carbide Shim Set (for Positive)

Compatible Insert	Set Model	Order No.	Carbide Shim	Carbide Shim Pin	Clamping Screw
VB1604	SVBS1604	807.555	VBS1604	VBP1604	VB-M3.5-4

Clamp Piece Set (for Negative)

Set Model	Order No.	(1) Clamp Piece	(2) Clamp Screw	(3) Spring	Compatible Insert
SCP2	973.182	CP2	M5 x 20	Ø8 x 10	DN1504, DN1506, CN1204
SCP7	807.554	CP7			DN1104







1. 1 pc. each of the clamp piece, clamp screw and spring are included in the set.
2. The tightening wrench is a 4 mm hex wrench.

Carbide Shim Set (for Negative)

Compatible Insert	Set Model	Order No.	(4) Carbide Shim	(5) Shim Clamp Screw	Torx size
DN1104	SDNS1104C	807.556	DNS1104C	M3×7	10IP
DN1504	SDNS1504C	807.557	DNS1504C	M4×8	15IP
DN1506	SDNS1506C	807.558	DNS1506C	M4×8	15IP
CN1204	SCNS1204C	807.559	CNS1204C	M4×8	15IP

1. 1 pc. each of the carbide shim and shim clamp screw are included in the set.
2. The tightening wrench is a torx wrench.

Accessories & Spare Parts

Inserts CC	Inserts CN	Inserts DC	Inserts DN	Inserts TC	Inserts VB
					
▶ 475	▶ 492	▶ 493	▶ 493	▶ 472	▶ 494

Hydraulic Chuck Lathe Type - Standard

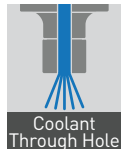

Simple slim design allows to mount various tool post positions. Coolant trough drills can be used for coolant delivery with Rc (PT) 1/8.

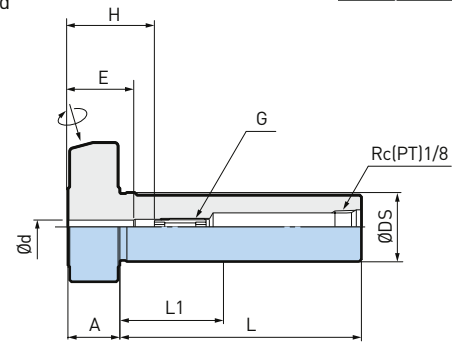
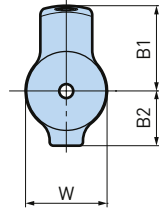

ø3 - 12mm

Model	Order No.	Ød	ØDs	L	L1	A	B1	B2	W	H	E	G
SL19.05-HDC3-60 *	807.220	3	19.05	60	40	15	24.5	15.8	22	20 - 32	16	HDA4-05015W
SL19.05-HDC4-60	806.991	4	19.05	60	40	15	24.5	15.8	22	23 - 32	19	HDA4-05015W
SL19.05-HDC6-60	806.992	6	19.05	60	40	15	24.5	15.8	22	31 - 48	25	NBA6B
SL19.05-HDC8-60 **	806.993	8	19.05	60	40	15	25.5	15.8	22	65	31	-
SL20-HDC3-70 *	807.221	3	20	70	40	15	24.5	15.8	23	20 - 32	16	HDA4-05015W
SL20-HDC4-70	807.222	4	20	70	40	15	24.5	15.8	23	23 - 32	19	HDA4-05015W
SL20-HDC6-70	807.223	6	20	70	40	15	24.5	15.8	23	31 - 48	25	NBA6B
SL20-HDC8-70 **	807.224	8	20	70	40	15	25.5	15.8	23	75	31	-
SL22-HDC3-70 *	807.225	3	22	70	40	15	24.5	15.8	25	20 - 32	16	HDA4-05015W
SL22-HDC4-70	806.994	4	22	70	40	15	24.5	15.8	25	23 - 32	19	HDA4-05015W
SL22-HDC6-70 **	806.995	6	22	70	40	15	24.5	15.8	25	31 - 48	25	NBA6B
SL22-HDC8-70 **	806.996	8	22	70	40	15	25.5	15.8	25	75	31	-
SL22-HDC10-70 **	807.488	10	22	70	40	15	27	16.8	25	70	33	-
SL25-HDC3-65 *	807.489	3	25	65	40	15	23	14	28	20 - 32	16	HDA4-05015W
SL25-HDC4-65	807.490	4	25	65	40	15	23	14	28	23 - 32	19	HDA4-05015W
SL25-HDC6-65	807.491	6	25	65	40	15	24.5	15	28	31 - 48	25	NBA6B
SL25-HDC8-65 **	807.492	8	25	65	40	15	25.5	16	28	70	31	-
SL25-HDC10-65 **	807.493	10	25	65	40	15	27	17	28	65	33	-
SL25-HDC12-65 **	807.497	12	25	65	40	15	28	18	28	65	36	-
SL25.4-HDC3-80 *	807.498	3	25.4	80	40	15	23	14	28	20 - 32	16	HDA4-05015W
SL25.4-HDC4-80	807.499	4	25.4	80	40	15	23	14	28	23 - 32	19	HDA4-05015W
SL25.4-HDC6-80	807.500	6	25.4	80	40	15	24.5	15	28	31 - 48	25	NBA6B
SL25.4-HDC8-80 **	807.501	8	25.4	80	40	15	25.5	16	28	85	31	-
SL25.4-HDC10-80 **	807.502	10	25.4	80	40	15	27	17	28	80	33	-
SL25.4-HDC12-80 **	807.503	12	25.4	80	40	15	28	18	28	80	36	-

A.7

- * Some coolant comes out from the inner slots in the case of the coolant-through application.
- ** Adjusting screw cannot be used.
- "E" is the min. clamping length.
- "G" is the adjusting screw.
- "H" is the max. tool shank length that can be inserted for these models.
- „H" for HDC8 is the maximum clamping depth of the cutting tool in the holder.
- „L1" is the minimum length, in case of shortening the shank.

- Machine
- Citizen
 - Star
 - Tsumagi
 - Tornos

Caution:

- Use only cutting tools that have a shank tolerance within h6.
- Do not use with cutting tools made with a flat on the shank. (ie: Weldon Type shank)
- Do not tighten the clamping screw without first inserting a cutting tool into the hydraulic chuck.
- Always insert the cutting tool into the hydraulic chuck beyond min. clamping length E.

Accessories & Spare Parts

<p>Adjusting Screws HDA</p>  <p>▶ 354</p>	<p>Adjusting Screws NBA</p>  <p>▶ 335</p>
--	--

Hydraulic Chuck Lathe Type - Type F



Single wrench enables the easy cutting tool change on the tool post. User-friendly rear clamping design is ideal for main tool blocks

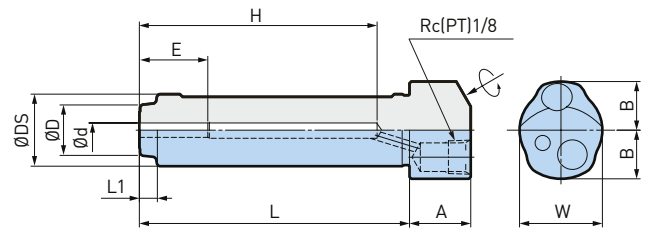

Model	Order No.	Ød	ØD	ØDs	L	L1	A	B	W	H	E
SL19.05F-HDC3-85 *	807.504	3	14	19.05	85	5	17	13.5	22	76	16
SL19.05F-HDC4-85	807.505	4	14	19.05	85	5	17	13.5	22	76	19
SL19.05F-HDC6-80	807.506	6	-	19.05	80	-	17	13.5	22	71	25
SL19.05F-HDC8-80	807.507	8	-	19.05	80	-	17	13.5	22	71	31
SL20F-HDC3-75 *	807.512	3	14	20	75	5	17	13.5	23	66	16
SL20F-HDC4-75	807.513	4	14	20	75	5	17	13.5	23	66	19
SL20F-HDC6-70	807.514	6	-	20	70	-	17	13.5	23	61	25
SL20F-HDC8-70	807.515	8	-	20	70	-	17	13.5	23	61	31
SL22F-HDC3-75 *	807.516	3	14	22	75	5	17	13.5	25	66	16
SL22F-HDC4-75	807.517	4	14	22	75	5	17	13.5	25	66	19
SL22F-HDC6-70	807.518	6	-	22	70	-	17	13.5	25	61	25
SL22F-HDC8-70	807.519	8	-	22	70	-	17	13.5	25	61	31
SL22F-HDC10-70	807.520	10	-	22	70	-	17	13.5	25	61	33
SL25F-HDC3-110	100911.001.0	3	14	25	110	7	-	13.5	-	82	16
SL25F-HDC4-110	100911.002.0	4	14	25	110	7	-	13.5	-	82	19
SL25F-HDC6-105	100911.003.0	6	14	25	105	3	-	13.5	-	77	25
SL25F-HDC8-100	100911.004.0	8	17	25	100	3	-	13.5	-	72	31
SL25F-HDC10-95	100911.005.0	10	-	25	95	-	-	13.5	-	67	33
SL25F-HDC12-90	100911.006.0	12	-	25	90	-	-	13.5	-	61	36
SL25.4F-HDC3-105	100911.007.0	3	14	25.4	105	7	-	13.5	-	77	16
SL25.4F-HDC4-105	100911.008.0	4	14	25.4	105	7	-	13.5	-	77	19
SL25.4F-HDC6-100	100911.009.0	6	14	25.4	100	3	-	13.5	-	72	25
SL25.4F-HDC8-95	100911.010.0	8	17	25.4	95	3	-	13.5	-	62	31
SL25.4F-HDC10-90	100911.011.0	10	-	25.4	90	-	-	13.5	-	67	33
SL25.4F-HDC12-85	100911.012.0	12	-	25.4	85	-	-	13.5	-	56	36

- * Some coolant comes out from the inner slots in the case of the coolant-through application.
- Adjusting screw cannot be used.
- "E" is the min. clamping length.
- "H" is the max. tool shank length that can be inserted for these models.

Machine

- Citizen
- Star
- Tsugami
- Tornos

Caution:

- Use only cutting tools that have a shank tolerance within h6.
- Do not use with cutting tools made with a flat on the shank. (ie: Weldon Type shank)
- Do not tighten the clamping screw without first inserting a cutting tool into the hydraulic chuck.
- Always insert the cutting tool into the hydraulic chuck beyond min. clamping length E.



Hydraulic Chuck Lathe Type - Type R



Unique block design enables easy handling for both upper or lower tool block positions. Coolant through drills can be used for coolant delivery with M6.

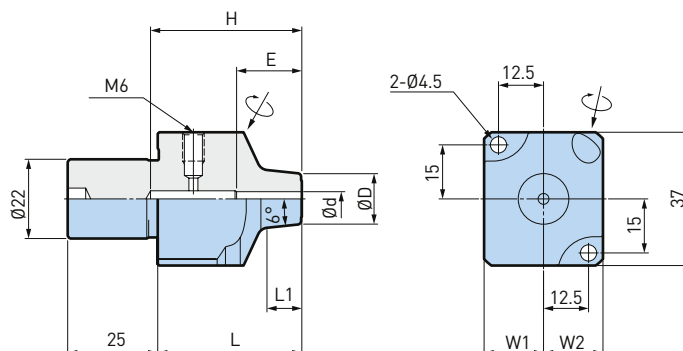

Model	Order No.	Ød	ØD	L	L1	W1	W2	H	E
SL22R-HDC3-40 *	807.521	3	14	40	7	16.5	16.5	35	16
SL22R-HDC4-40	807.522	4	14	40	9	16.5	16.5	42	19
SL22R-HDC6-40	807.523	6	18	40	5	16.5	16.5	55	25
SL22R-HDC8-40	807.524	8	20	40	6	16.5	17.5	54	31
SL22R-HDC10-40	807.525	10	22	40	6	16.5	17.5	54	33

- * Some coolant comes out from the inner slots in the case of the coolant-through application.
- Adjusting screw cannot be used.
- "E" is the min. clamping length.

- Machine**
- Citizen
 - Star
 - Tsugami
 - Tornos

Caution:

- Use only cutting tools that have a shank tolerance within h6.
- Do not use with cutting tools made with a flat on the shank. (ie: Weldon Type shank)
- Do not tighten the clamping screw without first inserting a cutting tool into the hydraulic chuck.
- Always insert the cutting tool into the hydraulic chuck beyond min. clamping length E.

Measurement Tools for Lathe



Base Master Mini BMM-20H
Magnetable user-friendly compact height detector

► 580



Centering tool for lathe CTL-90
Magnetable centering tool that the dial faces to the front while rotating the spindle detector

► 588



Collets & Accessories

Overview	322
Micro Collets	324
MEGA Nut / Micro Seal Nut / Micro Collet Case	326
New Baby Collets (NBC/FONBC/NBC-E)	327
New Baby Collet Set / Collet Ejector / Collet Remover	333
MEGA Nut / New Baby Nut	335
Adjusting Screws / Tap Driving Back Stops	335
MEGA Perfect Seal / Baby Perfect Seal (MPS/BPS)	336
MEGA E Collets / MEGA E Nut	340
MEGA E Perfect Seal (EPS)	341
MEGA ER Collets / Collet Remover	342
MEGA ER Nut	344
MEGA ER Perfect Seal (MERPS)	345
Straight Collets (PJC/PSC/OCA/C) / Adjusting Screws	347
MEGA Wrench / MEGA Torque Wrench / New Baby Wrench / FK Wrench	351
Digital MEGA Torque Wrench	353
Adjusting Screws / Test Bar for Hydraulic Chuck / Reduction Sleeve	355
MEGA Synchro Tapping Holder Accessories	356
Air Filter Regulator for RBX / Collet for Small Bore Type	366
Tooling Mate / Kombi Grip	367
Torque Fit	369
Cleaners	370
T-Slot Clean / Chip Fan	373
Pullstud Bolt / Pullstud Wrench	374
Set Up Information for Angle Heads / Air Turbine Spindle	376

MEGA Micro Chuck

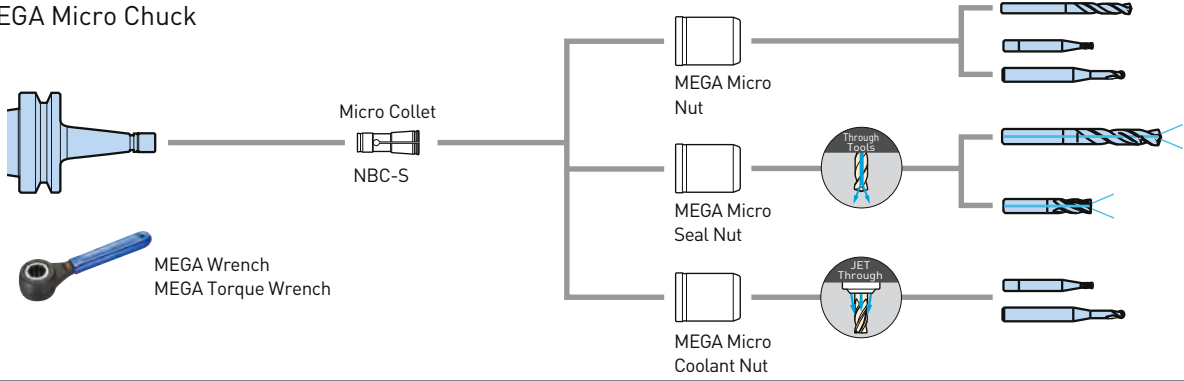

MEGA New Baby Chuck

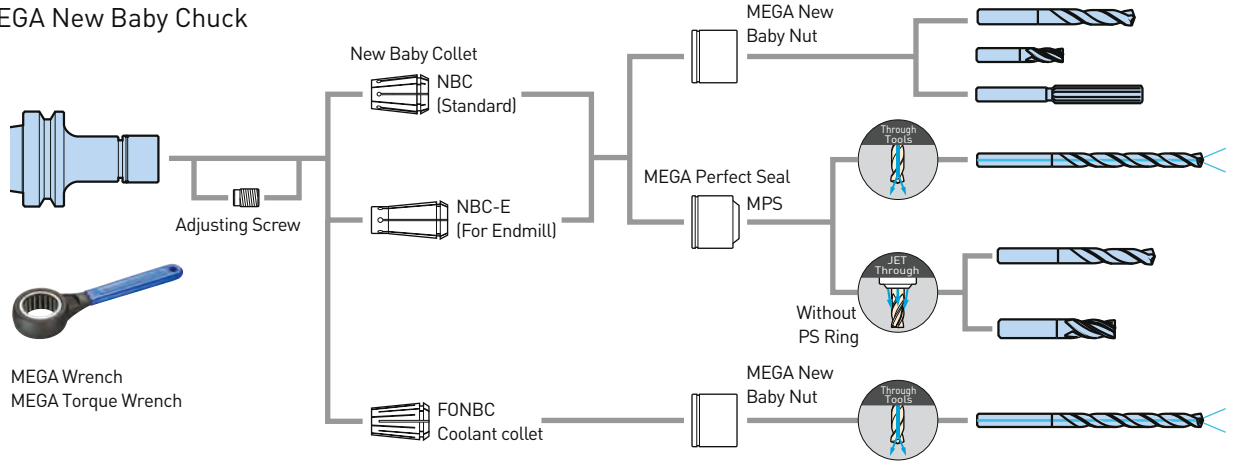

MEGA E Chuck

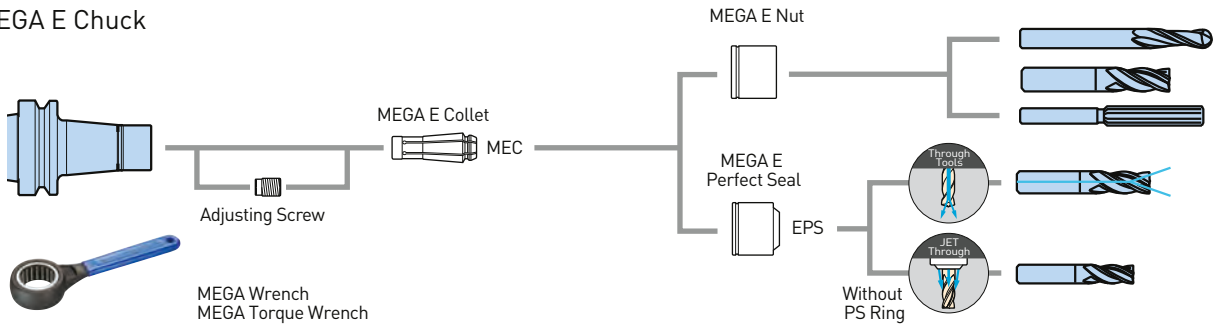

New Baby Chuck

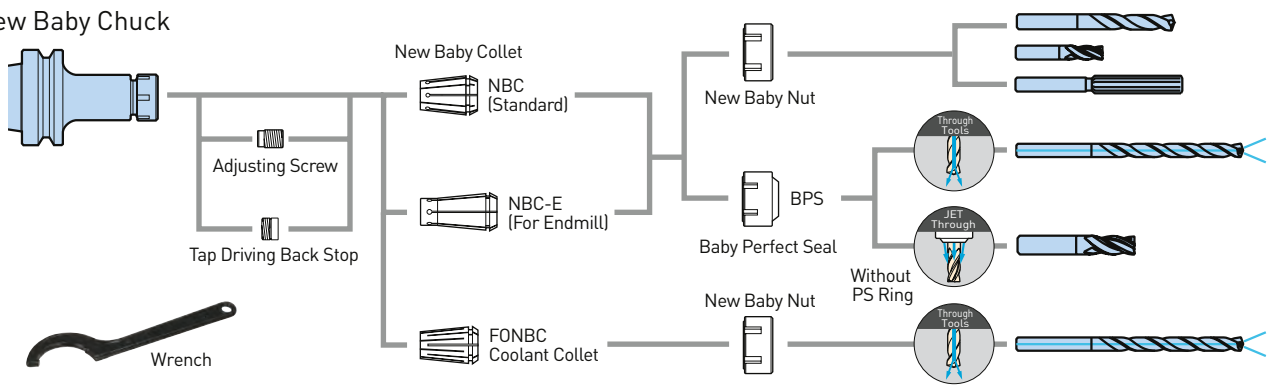

MEGA ER Grip

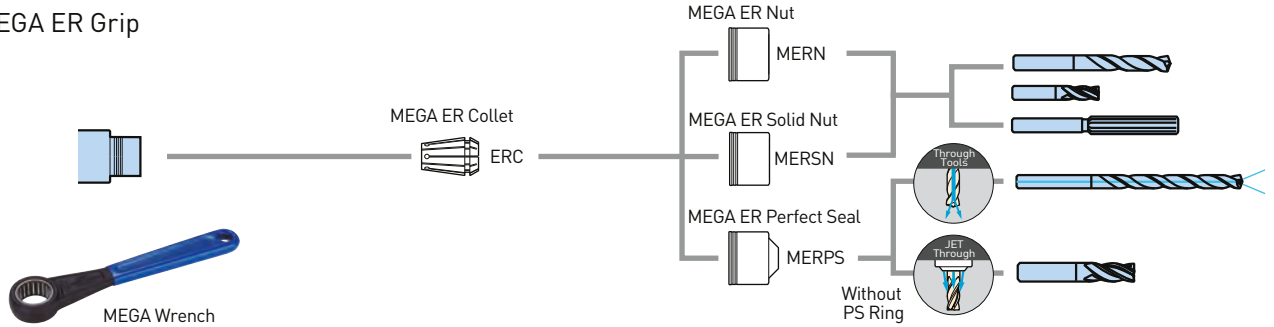

A.8

MEGA Double Power Chuck D type

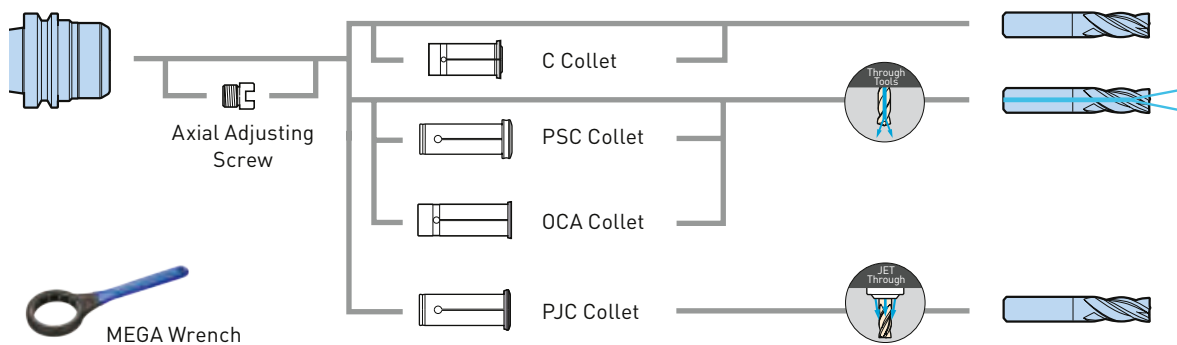

MEGA Double Power Chuck DS type

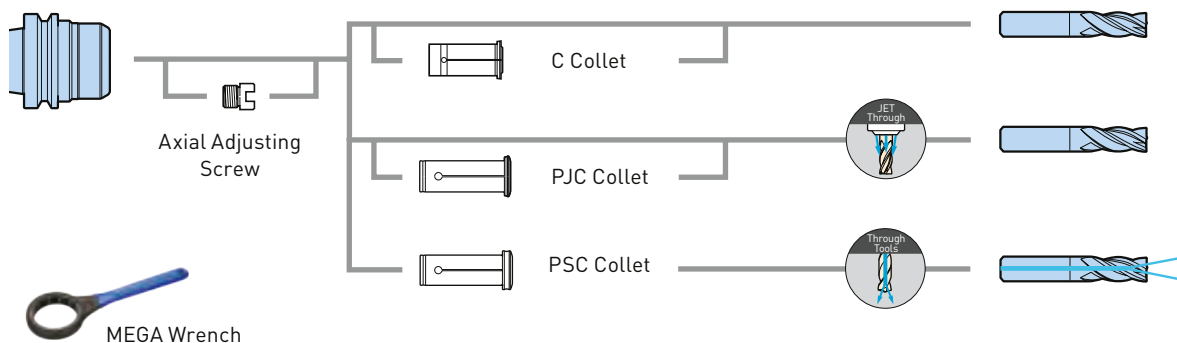

MEGA Synchro Tapping Holder MGT3

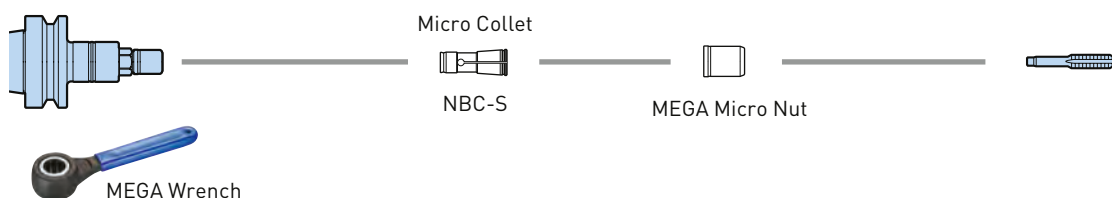

MEGA Synchro Tapping Holder MGT6, 12 and 20

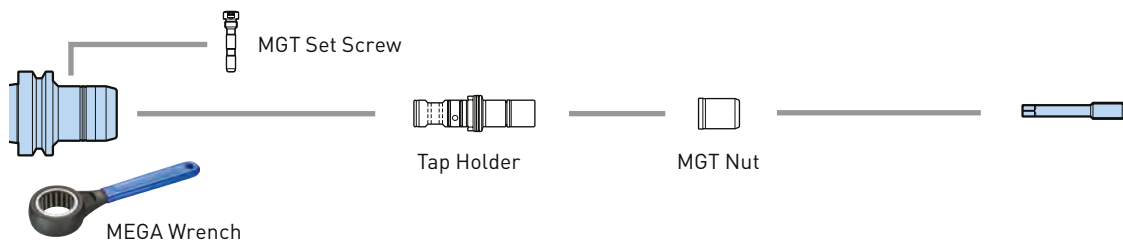

MEGA Synchro Tapping Holder MGT36

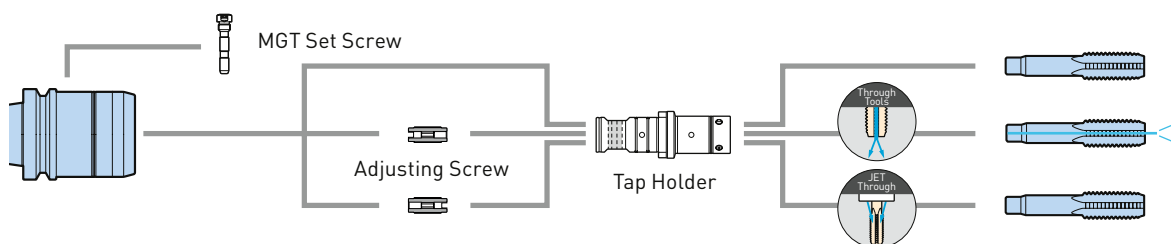

Micro Collets

For MEGA Micro Chuck

Available in 0.1 mm diameter increments to suit all the cutting tool shank sizes with maximum accuracy.

Despite their compact size, high clamping force and accuracy are achieved.

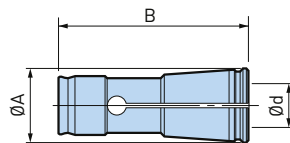

	Collet class	Max. runout	
	AA	At nose	4xD
		Within 1 µm	Within 3 µm

MEGA3S

Model	Order No.	Ød	ØA	B
NBC3S-0.5AA	968.301	0.45 - 0.55	6.06	18.8
NBC3S-0.6AA	968.302	0.55 - 0.65	6.06	18.8
NBC3S-0.7AA	968.303	0.65 - 0.75	6.06	18.8
NBC3S-0.8AA	968.304	0.75 - 0.85	6.06	18.8
NBC3S-0.9AA	968.305	0.85 - 0.95	6.06	18.8
NBC3S-1.0AA	968.306	0.95 - 1.05	6.06	18.8
NBC3S-1.1AA	968.307	1.05 - 1.15	6.06	18.8
NBC3S-1.2AA	968.308	1.15 - 1.25	6.06	18.8
NBC3S-1.3AA	968.309	1.25 - 1.35	6.06	18.8
NBC3S-1.4AA	968.310	1.35 - 1.45	6.06	18.8
NBC3S-1.5AA	968.311	1.45 - 1.55	6.06	18.8
NBC3S-1.6AA	968.312	1.55 - 1.65	6.06	18.8
NBC3S-1.7AA	968.313	1.65 - 1.75	6.06	18.8
NBC3S-1.8AA	968.314	1.75 - 1.85	6.06	18.8
NBC3S-1.9AA	968.315	1.85 - 1.95	6.06	18.8
NBC3S-2.0AA	968.316	1.95 - 2.05	6.06	18.8
NBC3S-2.1AA	968.317	2.05 - 2.15	6.06	18.8
NBC3S-2.2AA	968.318	2.15 - 2.25	6.06	18.8
NBC3S-2.3AA	968.319	2.25 - 2.35	6.06	18.8
NBC3S-2.4AA	968.320	2.35 - 2.45	6.06	18.8
NBC3S-2.5AA	968.321	2.45 - 2.55	6.06	18.8
NBC3S-2.6AA	968.322	2.55 - 2.65	6.06	18.8
NBC3S-2.7AA	968.323	2.65 - 2.75	6.06	18.8
NBC3S-2.8AA	968.324	2.75 - 2.85	6.06	18.8
NBC3S-2.9AA	968.325	2.85 - 2.95	6.06	18.8
NBC3S-3.0AA	968.326	2.95 - 3.05	6.06	18.8
NBC3S-3.1AA	968.327	3.05 - 3.15	6.06	18.8
NBC3S-3.175AA	968.328	3.125 - 3.225	6.06	18.8
NBC3S-3.2AA	968.329	3.15 - 3.25	6.06	18.8

MEGA4S

Model	Order No.	Ød	ØA	B
NBC4S-0.5AA	968.334	0.45 - 0.55	7.4	22.5
NBC4S-0.6AA	968.335	0.55 - 0.65	7.4	22.5
NBC4S-0.7AA	968.336	0.65 - 0.75	7.4	22.5
NBC4S-0.8AA	968.337	0.75 - 0.85	7.4	22.5
NBC4S-0.9AA	968.338	0.85 - 0.95	7.4	22.5
NBC4S-1.0AA	961.462	0.95 - 1.05	7.4	22.5
NBC4S-1.1AA	968.339	1.05 - 1.15	7.4	22.5
NBC4S-1.2AA	968.340	1.15 - 1.25	7.4	22.5
NBC4S-1.3AA	968.341	1.25 - 1.35	7.4	22.5
NBC4S-1.4AA	968.342	1.35 - 1.45	7.4	22.5
NBC4S-1.5AA	961.464	1.45 - 1.55	7.4	22.5
NBC4S-1.6AA	968.343	1.55 - 1.65	7.4	22.5
NBC4S-1.7AA	968.344	1.65 - 1.75	7.4	22.5
NBC4S-1.8AA	968.345	1.75 - 1.85	7.4	22.5
NBC4S-1.9AA	968.346	1.85 - 1.95	7.4	22.5
NBC4S-2.0AA	961.466	1.95 - 2.05	7.4	22.5
NBC4S-2.1AA	968.347	2.05 - 2.15	7.4	22.5
NBC4S-2.2AA	968.348	2.15 - 2.25	7.4	22.5
NBC4S-2.3AA	968.349	2.25 - 2.35	7.4	22.5
NBC4S-2.4AA	968.350	2.35 - 2.45	7.4	22.5
NBC4S-2.5AA	961.468	2.45 - 2.55	7.4	22.5
NBC4S-2.6AA	968.351	2.55 - 2.65	7.4	22.5
NBC4S-2.7AA	968.352	2.65 - 2.75	7.4	22.5
NBC4S-2.8AA	968.353	2.75 - 2.85	7.4	22.5
NBC4S-2.9AA	968.354	2.85 - 2.95	7.4	22.5
NBC4S-3.0AA	961.470	2.95 - 3.05	7.4	22.5
NBC4S-3.1AA	968.355	3.05 - 3.15	7.4	22.5
NBC4S-3.175AA	968.356	3.125 - 3.225	7.4	22.5
NBC4S-3.2AA	968.357	3.15 - 3.25	7.4	22.5
NBC4S-3.3AA	968.358	3.25 - 3.35	7.4	22.5
NBC4S-3.4AA	968.359	3.35 - 3.45	7.4	22.5
NBC4S-3.5AA	961.472	3.45 - 3.55	7.4	22.5
NBC4S-3.6AA	968.360	3.55 - 3.65	7.4	22.5
NBC4S-3.7AA	968.361	3.65 - 3.75	7.4	22.5
NBC4S-3.8AA	968.362	3.75 - 3.85	7.4	22.5
NBC4S-3.9AA	968.363	3.85 - 3.95	7.4	22.5
NBC4S-4.0AA	961.474	3.95 - 4.05	7.4	22.5

Micro Collets

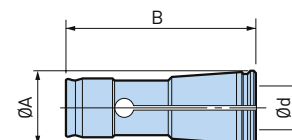

MEGA6S

Model	Order No.	Ød	ØA	B
NBC6S-0.5AA	968.369	0.45 - 0.55	9.4	24.5
NBC6S-0.6AA	968.370	0.55 - 0.65	9.4	24.5
NBC6S-0.7AA	968.371	0.65 - 0.75	9.4	24.5
NBC6S-0.8AA	968.372	0.75 - 0.85	9.4	24.5
NBC6S-0.9AA	968.373	0.85 - 0.95	9.4	24.5
NBC6S-1.0AA	961.477	0.95 - 1.05	9.4	24.5
NBC6S-1.1AA	968.374	1.05 - 1.15	9.4	24.5
NBC6S-1.2AA	968.375	1.15 - 1.25	9.4	24.5
NBC6S-1.3AA	968.376	1.25 - 1.35	9.4	24.5
NBC6S-1.4AA	968.377	1.35 - 1.45	9.4	24.5
NBC6S-1.5AA	961.479	1.45 - 1.55	9.4	24.5
NBC6S-1.6AA	968.378	1.55 - 1.65	9.4	24.5
NBC6S-1.7AA	968.379	1.65 - 1.75	9.4	24.5
NBC6S-1.8AA	968.380	1.75 - 1.85	9.4	24.5
NBC6S-1.9AA	968.381	1.85 - 1.95	9.4	24.5
NBC6S-2.0AA	961.481	1.95 - 2.05	9.4	24.5
NBC6S-2.1AA	968.382	2.05 - 2.15	9.4	24.5
NBC6S-2.2AA	968.383	2.15 - 2.25	9.4	24.5
NBC6S-2.3AA	968.384	2.25 - 2.35	9.4	24.5
NBC6S-2.4AA	968.385	2.35 - 2.45	9.4	24.5
NBC6S-2.5AA	961.483	2.45 - 2.55	9.4	24.5
NBC6S-2.6AA	968.386	2.55 - 2.65	9.4	24.5
NBC6S-2.7AA	968.387	2.65 - 2.75	9.4	24.5
NBC6S-2.8AA	968.388	2.75 - 2.85	9.4	24.5
NBC6S-2.9AA	968.389	2.85 - 2.95	9.4	24.5
NBC6S-3.0AA	961.485	2.95 - 3.05	9.4	24.5
NBC6S-3.1AA	968.390	3.05 - 3.15	9.4	24.5
NBC6S-3.175AA	968.391	3.125 - 3.225	9.4	24.5
NBC6S-3.2AA	968.392	3.15 - 3.25	9.4	24.5
NBC6S-3.3AA	968.393	3.25 - 3.35	9.4	24.5
NBC6S-3.4AA	968.394	3.35 - 3.45	9.4	24.5
NBC6S-3.5AA	961.487	3.45 - 3.55	9.4	24.5
NBC6S-3.6AA	968.395	3.55 - 3.65	9.4	24.5
NBC6S-3.7AA	968.396	3.65 - 3.75	9.4	24.5
NBC6S-3.8AA	968.397	3.75 - 3.85	9.4	24.5
NBC6S-3.9AA	968.398	3.85 - 3.95	9.4	24.5
NBC6S-4.0AA	961.489	3.95 - 4.05	9.4	24.5
NBC6S-4.1AA	968.399	4.05 - 4.15	9.4	24.5
NBC6S-4.2AA	968.400	4.15 - 4.25	9.4	24.5
NBC6S-4.3AA	968.401	4.25 - 4.35	9.4	24.5
NBC6S-4.4AA	968.402	4.35 - 4.45	9.4	24.5
NBC6S-4.5AA	961.491	4.45 - 4.55	9.4	24.5
NBC6S-4.6AA	968.403	4.55 - 4.65	9.4	24.5
NBC6S-4.7AA	968.404	4.65 - 4.75	9.4	24.5
NBC6S-4.7625AA	801.743	4.7125 - 4.8125	9.4	24.5
NBC6S-4.8AA	968.405	4.75 - 4.85	9.4	24.5
NBC6S-4.9AA	968.406	4.85 - 4.95	9.4	24.5
NBC6S-5.0AA	961.493	4.95 - 5.05	9.4	24.5
NBC6S-5.1AA	968.408	5.05 - 5.15	9.4	24.5
NBC6S-5.2AA	968.409	5.15 - 5.25	9.4	24.5
NBC6S-5.3AA	968.410	5.25 - 5.35	9.4	24.5
NBC6S-5.4AA	968.411	5.35 - 5.45	9.4	24.5
NBC6S-5.5AA	961.495	5.45 - 5.55	9.4	24.5
NBC6S-5.6AA	968.412	5.55 - 5.65	9.4	24.5
NBC6S-5.7AA	968.413	5.65 - 5.75	9.4	24.5
NBC6S-5.8AA	968.414	5.75 - 5.85	9.4	24.5
NBC6S-5.9AA	968.415	5.85 - 5.95	9.4	24.5
NBC6S-6.0AA	961.497	5.95 - 6.05	9.4	24.5

MEGA8S

Model	Order No.	Ød	ØA	B
NBC8S-3.0AA	801.709	2.95 - 3.05	12	27
NBC8S-3.1AA	804.132	3.05 - 3.15	12	27
NBC8S-3.175AA	804.133	3.170 - 3.180	12	27
NBC8S-3.2AA	804.134	3.15 - 3.25	12	27
NBC8S-3.3AA	804.135	3.25 - 3.35	12	27
NBC8S-3.4AA	804.136	3.35 - 3.45	12	27
NBC8S-3.5AA	804.137	3.45 - 3.55	12	27
NBC8S-3.6AA	804.138	3.55 - 3.65	12	27
NBC8S-3.7AA	804.139	3.65 - 3.75	12	27
NBC8S-3.8AA	804.140	3.75 - 3.85	12	27
NBC8S-3.9AA	804.141	3.85 - 3.95	12	27
NBC8S-4.0AA	801.742	3.95 - 4.05	12	27
NBC8S-4.1AA	804.142	4.05 - 4.15	12	27
NBC8S-4.2AA	804.143	4.15 - 4.25	12	27
NBC8S-4.3AA	804.144	4.25 - 4.35	12	27
NBC8S-4.4AA	804.145	4.35 - 4.45	12	27
NBC8S-4.5AA	804.146	4.45 - 4.55	12	27
NBC8S-4.6AA	804.147	4.55 - 4.65	12	27
NBC8S-4.7AA	804.148	4.65 - 4.75	12	27
NBC8S-4.8AA	804.149	4.75 - 4.85	12	27
NBC8S-4.9AA	804.150	4.85 - 4.95	12	27
NBC8S-5.0AA	801.702	4.95 - 5.05	12	27
NBC8S-5.1AA	804.151	5.05 - 5.15	12	27
NBC8S-5.2AA	804.152	5.15 - 5.25	12	27
NBC8S-5.3AA	804.153	5.25 - 5.35	12	27
NBC8S-5.4AA	804.154	5.35 - 5.45	12	27
NBC8S-5.5AA	804.155	5.45 - 5.55	12	27
NBC8S-5.6AA	804.156	5.55 - 5.65	12	27
NBC8S-5.7AA	804.157	5.65 - 5.75	12	27
NBC8S-5.8AA	804.158	5.75 - 5.85	12	27
NBC8S-5.9AA	801.746	5.85 - 5.95	12	27
NBC8S-6.0AA	801.703	5.95 - 6.05	12	27
NBC8S-6.1AA	804.159	6.05 - 6.15	12	27
NBC8S-6.2AA	804.160	6.15 - 6.25	12	27
NBC8S-6.3AA	804.161	6.25 - 6.35	12	27
NBC8S-6.4AA	804.162	6.35 - 6.45	12	27
NBC8S-6.5AA	804.163	6.45 - 6.55	12	27
NBC8S-6.6AA	804.164	6.55 - 6.65	12	27
NBC8S-6.7AA	804.165	6.65 - 6.75	12	27
NBC8S-6.8AA	804.166	6.75 - 6.85	12	27
NBC8S-6.9AA	804.167	6.85 - 6.95	12	27
NBC8S-7.0AA	804.168	6.95 - 7.05	12	27
NBC8S-7.1AA	804.169	7.05 - 7.15	12	27
NBC8S-7.2AA	804.170	7.15 - 7.25	12	27
NBC8S-7.3AA	804.171	7.25 - 7.35	12	27
NBC8S-7.4AA	804.172	7.35 - 7.45	12	27
NBC8S-7.5AA	804.173	7.45 - 7.55	12	27
NBC8S-7.6AA	804.174	7.55 - 7.65	12	27
NBC8S-7.7AA	804.175	7.65 - 7.75	12	27
NBC8S-7.8AA	804.176	7.75 - 7.85	12	27
NBC8S-7.9AA	804.177	7.85 - 7.95	12	27
NBC8S-8.0AA	801.704	7.95 - 8.05	12	27

A.8

MEGA Nuts

For MEGA Micro Chuck

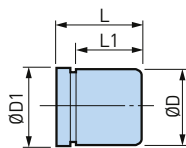

Model	Order No.	ØD	ØD1	L	L1	Body
MGN3S	969.480	10	10.3	13	11	MEGA3S
MGN4S	969.481	12	12.2	14.5	12	MEGA4S
MGN6S	969.482	14	14.2	17	14.5	MEGA6S
MGN8S	804.108	18	18.3	18.5	15.5	MEGA8S

Micro Seal Nuts

For MEGA Micro Chuck
Sealed nut for coolant-through tools.

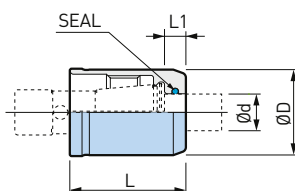

Model	Order No.	Ød	ØD	L	L1	Body
MGN6S-PS3	978.516	3	14	19	3.5	MEGA6S
MGN6S-PS4	978.513	4	14	19	3.5	MEGA6S
MGN6S-PS5	978.517	5	14	19	3.5	MEGA6S
MGN6S-PS6	978.511	6	14	19	3.5	MEGA6S
MGN8S-PS3	804.109	3	18	20.2	3.5	MEGA8S
MGN8S-PS4	804.110	4	18	20.2	3.5	MEGA8S
MGN8S-PS5	804.111	5	18	20.2	3.5	MEGA8S
MGN8S-PS6	804.112	6	18	20.2	3.5	MEGA8S
MGN8S-PS7	804.113	7	18	20.2	3.5	MEGA8S
MGN8S-PS8	804.114	8	18	20.2	3.5	MEGA8S

MEGA Micro Coolant Nut

For MEGA Micro Chuck
MEGA Micro Coolant Nut, only for MEGA Micro Chuck 6S for more efficient coolant supply for micro cutting tool.

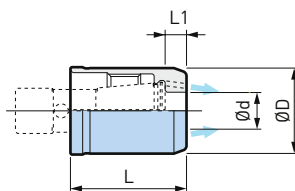

Model	Order No.	Ød	ØD	L	L1	Body
MGN6S-2J	806.862	2	14	19	3.5	MEGA6S
MGN6S-3J	806.863	3	14	19	3.5	MEGA6S
MGN6S-4J	806.864	4	14	19	3.5	MEGA6S
MGN6S-5J	806.865	5	14	17	1.5	MEGA6S
MGN6S-6J	806.866	6	14	17	1.5	MEGA6S

Collet Protective Cases

Exclusive case for MEGA Micro Collet.



Model	Order No.	Number of Holes	Size	Collet Model
NBB3S	968.330	50	200 x 170 x 50	NBC3S
NBB4S	968.364	50	200 x 170 x 50	NBC4S
NBB6S	961.498	60	200 x 170 x 50	NBC6S
NBB8S	805.802	60	200 x 170 x 50	NBC8S

1. Micro collet is not included.

New Baby Collets

For MEGA New Baby Chuck and New Baby Chuck

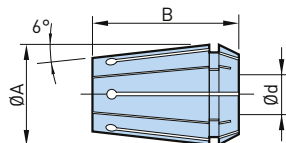

Collet class	Max. runout	
	At nose	4xD
AA	Within 1 µm	Within 3 µm

MEGA6N / NBS6

Model	Order No.	Ød	ØA	B
NBC6-0.5AA	961.500	0.25 - 0.5	9.5	14
NBC6-0.75AA	961.501	0.5 - 0.75	9.5	14
NBC6-1AA	961.502	0.75 - 1	9.5	14
NBC6-1.25AA	961.503	1 - 1.25	9.5	14
NBC6-1.5AA	961.504	1.25 - 1.5	9.5	14
NBC6-1.75AA	961.505	1.5 - 1.75	9.5	14
NBC6-2AA	961.506	1.75 - 2	9.5	14
NBC6-2.25AA	961.507	2 - 2.25	9.5	14
NBC6-2.5AA	961.508	2.25 - 2.5	9.5	14
NBC6-2.75AA	961.509	2.5 - 2.75	9.5	14
NBC6-3AA	961.510	2.75 - 3	9.5	14
NBC6-3.175AA	801.738	2.925 - 3.175	9.5	14
NBC6-3.25AA	961.511	3 - 3.25	9.5	14
NBC6-3.5AA	961.512	3.25 - 3.5	9.5	14
NBC6-3.75AA	961.513	3.5 - 3.75	9.5	14
NBC6-4AA	961.514	3.75 - 4	9.5	14
NBC6-4.25AA	961.515	4 - 4.25	9.5	14
NBC6-4.5AA	961.516	4.25 - 4.5	9.5	14
NBC6-4.75AA	961.517	4.5 - 4.75	9.5	14
NBC6-5AA	961.518	4.75 - 5	9.5	14
NBC6-5.25AA	961.519	5 - 5.25	9.5	14
NBC6-5.5AA	961.520	5.25 - 5.5	9.5	14
NBC6-5.75AA	961.521	5.5 - 5.75	9.5	14
NBC6-6AA	961.522	5.75 - 6	9.5	14

MEGA8N / NBS8

Model	Order No.	Ød	ØA	B
NBC8-0.75AA	978.507	0.5 - 0.75	12.5	18
NBC8-1AA	961.531	0.75 - 1	12.5	18
NBC8-1.25AA	978.500	1 - 1.25	12.5	18
NBC8-1.5AA	961.532	1.25 - 1.5	12.5	18
NBC8-1.75AA	801.744	1.5 - 1.75	12.5	18
NBC8-2AA	961.533	1.75 - 2	12.5	18
NBC8-2.25AA	978.505	2 - 2.25	12.5	18
NBC8-2.5AA	961.534	2.25 - 2.5	12.5	18
NBC8-2.75AA	978.506	2.5 - 2.75	12.5	18
NBC8-3AA	961.535	2.75 - 3	12.5	18
NBC8-3.175AA	978.499	2.675 - 3.175	12.5	18
NBC8-3.5AA	961.536	3 - 3.5	12.5	18
NBC8-4AA	961.537	3.5 - 4	12.5	18
NBC8-4.5AA	961.538	4 - 4.5	12.5	18
NBC8-5AA	961.539	4.5 - 5	12.5	18
NBC8-5.25AA	801.750	4.75 - 5.25	12.5	18
NBC8-5.5AA	961.540	5 - 5.5	12.5	18
NBC8-5.75AA	801.751	5.25 - 5.75	12.5	18
NBC8-6AA	961.541	5.5 - 6	12.5	18
NBC8-6.5AA	961.542	6 - 6.5	12.5	18
NBC8-7AA	961.543	6.5 - 7	12.5	18
NBC8-7.5AA	961.544	7 - 7.5	12.5	18
NBC8-8AA	961.545	7.5 - 8	12.5	18

A.8

MEGA10N / NBS10

Model	Order No.	Ød	ØA	B
NBC10-1.75AA	961.599	1.5 - 1.75	16.5	27
NBC10-2AA	961.551	1.75 - 2	16.5	27
NBC10-2.25AA	978.508	2 - 2.25	16.5	27
NBC10-2.5AA	961.552	2.25 - 2.5	16.5	27
NBC10-2.75AA	978.509	2.5 - 2.75	16.5	27
NBC10-3AA	961.553	2.75 - 3	16.5	27
NBC10-3.175AA	961.120	2.675 - 3.175	16.5	27
NBC10-3.25AA	801.651	2.75 - 3.25	16.5	27
NBC10-3.5AA	961.554	3 - 3.5	16.5	27
NBC10-3.75AA	801.652	3.25 - 3.75	16.5	27
NBC10-4AA	961.555	3.5 - 4	16.5	27
NBC10-4.25AA	801.655	3.75 - 4.25	16.5	27
NBC10-4.5AA	961.556	4 - 4.5	16.5	27
NBC10-4.75AA	801.656	4.25 - 4.75	16.5	27

Model	Order No.	Ød	ØA	B
NBC10-5AA	961.557	4.5 - 5	16.5	27
NBC10-5.25AA	801.659	4.75 - 5.25	16.5	27
NBC10-5.5AA	961.558	5 - 5.5	16.5	27
NBC10-5.75AA	801.660	5.25 - 5.75	16.5	27
NBC10-6AA	961.559	5.5 - 6	16.5	27
NBC10-6.5AA	961.560	6 - 6.5	16.5	27
NBC10-7AA	961.561	6.5 - 7	16.5	27
NBC10-7.5AA	961.562	7 - 7.5	16.5	27
NBC10-8AA	961.563	7.5 - 8	16.5	27
NBC10-8.5AA	961.564	8 - 8.5	16.5	27
NBC10-9AA	961.565	8.5 - 9	16.5	27
NBC10-9.5AA	961.566	9 - 9.5	16.5	27
NBC10-10AA	961.567	9.5 - 10	16.5	27

▣ Models are included in new baby collet set.

MEGA13N / NBS13

Model	Order No.	Ød	ØA	B
NBC13-3AA	961.573	□ 2.5 - 3	20.5	31
NBC13-3.175AA	961.127	2.675 - 3.175	20.5	31
NBC13-3.25AA	801.671	2.75 - 3.25	20.5	31
NBC13-3.5AA	961.574	□ 3 - 3.5	20.5	31
NBC13-3.75AA	801.672	3.25 - 3.75	20.5	31
NBC13-4AA	961.575	□ 3.5 - 4	20.5	31
NBC13-4.25AA	801.675	3.75 - 4.25	20.5	31
NBC13-4.5AA	961.576	□ 4 - 4.5	20.5	31
NBC13-4.75AA	801.676	4.25 - 4.75	20.5	31
NBC13-5AA	961.577	□ 4.5 - 5	20.5	31
NBC13-5.25AA	801.679	4.75 - 5.25	20.5	31
NBC13-5.5AA	961.578	□ 5 - 5.5	20.5	31
NBC13-5.75AA	801.680	5.25 - 5.75	20.5	31
NBC13-6AA	961.579	□ 5.5 - 6	20.5	31
NBC13-6.5AA	961.580	□ 6 - 6.5	20.5	31
NBC13-7AA	961.581	□ 6.5 - 7	20.5	31
NBC13-7.5AA	961.582	□ 7 - 7.5	20.5	31
NBC13-8AA	961.583	□ 7.5 - 8	20.5	31
NBC13-8.5AA	961.584	□ 8 - 8.5	20.5	31
NBC13-9AA	961.585	□ 8.5 - 9	20.5	31
NBC13-9.5AA	961.586	□ 9 - 9.5	20.5	31
NBC13-10AA	961.587	□ 9.5 - 10	20.5	31
NBC13-10.5AA	961.588	□ 10 - 10.5	20.5	31
NBC13-11AA	961.589	□ 10.5 - 11	20.5	31
NBC13-11.5AA	961.590	□ 11 - 11.5	20.5	31
NBC13-12AA	961.591	□ 11.5 - 12	20.5	31
NBC13-12.5AA	961.592	□ 12 - 12.5	20.5	31
NBC13-13AA	961.593	□ 12.5 - 13	20.5	31

MEGA16N / NBS16

Model	Order No.	Ød	ØA	B
NBC16-3AA	961.601	□ 2.5 - 3	25.5	35
NBC16-3.25AA	801.694	2.75 - 3.25	25.5	35
NBC16-3.5AA	961.602	□ 3 - 3.5	25.5	35
NBC16-3.75AA	801.695	3.25 - 3.75	25.5	35
NBC16-4AA	961.603	□ 3.5 - 4	25.5	35
NBC16-4.25AA	801.697	3.75 - 4.25	25.5	35
NBC16-4.5AA	961.604	□ 4 - 4.5	25.5	35
NBC16-4.75AA	801.698	4.25 - 4.75	25.5	35
NBC16-5AA	961.605	□ 4.5 - 5	25.5	35
NBC16-5.25AA	801.700	4.75 - 5.25	25.5	35
NBC16-5.5AA	961.606	□ 5 - 5.5	25.5	35
NBC16-5.75AA	801.701	5.25 - 5.75	25.5	35
NBC16-6AA	961.607	□ 5.5 - 6	25.5	35
NBC16-6.5AA	961.608	□ 6 - 6.5	25.5	35
NBC16-7AA	961.609	□ 6.5 - 7	25.5	35
NBC16-7.5AA	961.610	□ 7 - 7.5	25.5	35
NBC16-8AA	961.611	□ 7.5 - 8	25.5	35
NBC16-8.5AA	961.612	□ 8 - 8.5	25.5	35
NBC16-9AA	961.613	□ 8.5 - 9	25.5	35
NBC16-9.5AA	961.614	□ 9 - 9.5	25.5	35
NBC16-10AA	961.615	□ 9.5 - 10	25.5	35
NBC16-10.5AA	961.616	□ 10 - 10.5	25.5	35
NBC16-11AA	961.617	□ 10.5 - 11	25.5	35
NBC16-11.5AA	961.618	□ 11 - 11.5	25.5	35
NBC16-12AA	961.619	□ 11.5 - 12	25.5	35
NBC16-12.5AA	961.620	□ 12 - 12.5	25.5	35
NBC16-13AA	961.621	□ 12.5 - 13	25.5	35
NBC16-13.5AA	961.622	□ 13 - 13.5	25.5	35
NBC16-14AA	961.623	□ 13.5 - 14	25.5	35
NBC16-14.5AA	961.624	□ 14 - 14.5	25.5	35
NBC16-15AA	961.625	□ 14.5 - 15	25.5	35
NBC16-15.5AA	961.626	□ 15 - 15.5	25.5	35
NBC16-16AA	961.627	□ 15.5 - 16	25.5	35

□ Models are included in new baby collet set.

New Baby Collets

For MEGA New Baby Chuck and New Baby Chuck

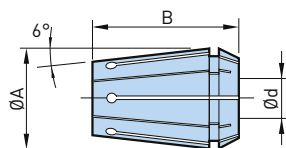

	Within 1µm	Within 3µm	4d	Ød	Collet class	Max. runout	
					AA	At nose	4xD
	Within 1µm	Within 3µm			AA	Within 1µm	Within 3µm

MEGA20N / NBS20

Model	Order No.	Ød	ØA	B
NBC20-3AA	961.641	2.5 - 3	28.5	38
NBC20-3.25AA	801.718	2.75 - 3.25	28.5	38
NBC20-3.5AA	961.642	3 - 3.5	28.5	38
NBC20-3.75AA	801.719	3.25 - 3.75	28.5	38
NBC20-4AA	961.643	3.5 - 4	28.5	38
NBC20-4.25AA	801.722	3.75 - 4.25	28.5	38
NBC20-4.5AA	961.644	4 - 4.5	28.5	38
NBC20-4.75AA	801.723	4.25 - 4.75	28.5	38
NBC20-5AA	961.645	4.5 - 5	28.5	38
NBC20-5.25AA	801.726	4.75 - 5.25	28.5	38
NBC20-5.5AA	961.646	5 - 5.5	28.5	38
NBC20-5.75AA	801.727	5.25 - 5.75	28.5	38
NBC20-6AA	961.647	5.5 - 6	28.5	38
NBC20-6.5AA	961.648	6 - 6.5	28.5	38
NBC20-7AA	961.649	6.5 - 7	28.5	38
NBC20-7.5AA	961.650	7 - 7.5	28.5	38
NBC20-8AA	961.651	7.5 - 8	28.5	38
NBC20-8.5AA	961.652	8 - 8.5	28.5	38
NBC20-9AA	961.653	8.5 - 9	28.5	38
NBC20-9.5AA	961.654	9 - 9.5	28.5	38
NBC20-10AA	961.655	9.5 - 10	28.5	38
NBC20-10.5AA	961.656	10 - 10.5	28.5	38
NBC20-11AA	961.657	10.5 - 11	28.5	38
NBC20-11.5AA	961.658	11 - 11.5	28.5	38
NBC20-12AA	961.659	11.5 - 12	28.5	38
NBC20-12.5AA	961.660	12 - 12.5	28.5	38
NBC20-13AA	961.661	12.5 - 13	28.5	38
NBC20-13.5AA	961.662	13 - 13.5	28.5	38
NBC20-14AA	961.663	13.5 - 14	28.5	38
NBC20-14.5AA	961.664	14 - 14.5	28.5	38
NBC20-15AA	961.665	14.5 - 15	28.5	38
NBC20-15.5AA	961.666	15 - 15.5	28.5	38
NBC20-16AA	961.667	15.5 - 16	28.5	38
NBC20-16.5AA	961.668	16 - 16.5	28.5	38
NBC20-17AA	961.669	16.5 - 17	28.5	38
NBC20-17.5AA	961.670	17 - 17.5	28.5	38
NBC20-18AA	961.671	17.5 - 18	28.5	38
NBC20-18.5AA	961.672	18 - 18.5	28.5	38
NBC20-19AA	961.673	18.5 - 19	28.5	38
NBC20-19.5AA	961.674	19 - 19.5	28.5	38
NBC20-20AA	961.675	19.5 - 20	28.5	38

MEGA25N

Model	Order No.	Ød	ØA	B
NBC25-16AA	806.390	15.5 - 16	35.5	52
NBC25-16.5AA	806.391	16 - 16.5	35.5	52
NBC25-17AA	806.392	16.5 - 17	35.5	52
NBC25-17.5AA	806.393	17 - 17.5	35.5	52
NBC25-18AA	806.394	17.5 - 18	35.5	52
NBC25-18.5AA	806.395	18 - 18.5	35.5	52
NBC25-19AA	806.396	18.5 - 19	35.5	52
NBC25-19.5AA	806.397	19 - 19.5	35.5	52
NBC25-20AA	806.398	19.5 - 20	35.5	52
NBC25-20.5AA	806.399	20 - 20.5	35.5	52
NBC25-21AA	806.400	20.5 - 21	35.5	52
NBC25-21.5AA	806.401	21 - 21.5	35.5	52
NBC25-22AA	806.402	21.5 - 22	35.5	52
NBC25-22.5AA	806.403	22 - 22.5	35.5	52
NBC25-23AA	806.404	22.5 - 23	35.5	52
NBC25-23.5AA	806.405	23 - 23.5	35.5	52
NBC25-24AA	806.406	23.5 - 24	35.5	52
NBC25-24.5AA	806.407	24 - 24.5	35.5	52
NBC25-25AA	806.408	24.5 - 25	35.5	52
NBC25-25.4AA	806.409	24.9 - 25.4	35.5	52

A.8

▣ Models are included in new baby collet set.

New Baby Collets for Endmills

For MEGA New Baby Chuck and New Baby Chuck

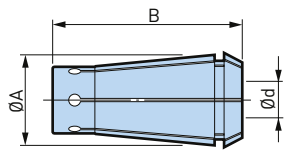

	Max. runout	
	At nose	4xD
AA	Within 1 µm	Within 3 µm

MEGA6N / NBS6

Model	Order No.	Ød	ØA	B
NBC6-3EAA	961.148	3	9.2	17
NBC6-4EAA	961.149	4	9.2	17
NBC6-5EAA	961.150	5	9.2	17
NBC6-6EAA	961.151	6	9.2	17

MEGA8N / NBS8

Model	Order No.	Ød	ØA	B
NBC8-3EAA	961.152	3	12	20
NBC8-4EAA	961.153	4	12	20
NBC8-5EAA	961.154	5	12	20
NBC8-6EAA	961.155	6	12	20
NBC8-8EAA	961.156	8	12	20

MEGA10N / NBS10

Model	Order No.	Ød	ØA	B
NBC10-3EAA	801.654	3	16	32
NBC10-4EAA	801.658	4	16	32
NBC10-5EAA	801.662	5	16	32
NBC10-6EAA	961.160	6	16	32
NBC10-8EAA	961.161	8	16	32
NBC10-10EAA	961.146	10	16	32

MEGA13N / NBS13

Model	Order No.	Ød	ØA	B
NBC13-3EAA	801.674	3	20	38
NBC13-4EAA	801.678	4	20	38
NBC13-5EAA	801.682	5	20	38
NBC13-6EAA	961.165	6	20	38
NBC13-8EAA	961.166	8	20	38
NBC13-10EAA	961.147	10	20	38
NBC13-12EAA	961.167	12	20	38

MEGA16N / NBS16

Model	Order No.	Ød	ØA	B
NBC16-3EAA	961.168	3	25	42
NBC16-4EAA	961.169	4	25	42
NBC16-5EAA	961.170	5	25	42
NBC16-6EAA	961.171	6	25	42
NBC16-8EAA	961.172	8	25	42
NBC16-10EAA	961.173	10	25	42
NBC16-12EAA	961.174	12	25	42
NBC16-14EAA	961.175	14	25	42
NBC16-16EAA	961.176	16	25	42

MEGA20N / NBS20

Model	Order No.	Ød	ØA	B
NBC20-3EAA	801.721	3	28	45
NBC20-4EAA	801.725	4	28	45
NBC20-5EAA	801.729	5	28	45
NBC20-6EAA	961.180	6	28	45
NBC20-8EAA	801.733	8	28	45
NBC20-10EAA	961.182	10	28	45
NBC20-12EAA	961.183	12	28	45
NBC20-14EAA	961.184	14	28	45
NBC20-16EAA	961.185	16	28	45
NBC20-20EAA	961.186	20	28	45

1. Use only a cutting tool shank with exactly the same diameter as the collet bore diameter.
2. Tolerance of the cutting tool shank must be within h7.

A.8

FONBC Coolant Collets

For MEGA New Baby Chuck and New Baby Chuck
Optimum collet for center-through coolant applications with coolant-through cutting tools.

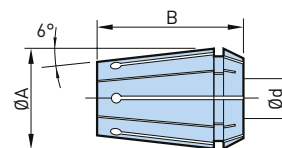
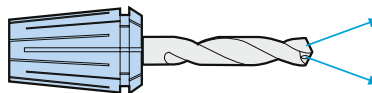

MEGA6N / NBS6

Model	Order No.	Ød	ØA	B
FONBC6-3AA	969.601	3.00 *	9.5	14
FONBC6-3.25AA	969.602	3.15 - 3.25	9.5	14
FONBC6-3.5AA	969.603	3.4 - 3.5	9.5	14
FONBC6-3.75AA	969.604	3.65 - 3.75	9.5	14
FONBC6-4AA	969.605	3.9 - 4	9.5	14
FONBC6-4.25AA	969.606	4.15 - 4.25	9.5	14
FONBC6-4.5AA	969.607	4.4 - 4.5	9.5	14
FONBC6-4.75AA	969.608	4.65 - 4.75	9.5	14
FONBC6-5AA	969.609	4.9 - 5	9.5	14
FONBC6-5.25AA	969.610	5.15 - 5.25	9.5	14
FONBC6-5.5AA	969.611	5.4 - 5.5	9.5	14
FONBC6-5.75AA	969.612	5.65 - 5.75	9.5	14
FONBC6-6AA	969.613	5.9 - 6	9.5	14

MEGA8N / NBS8

Model	Order No.	Ød	ØA	B
FONBC8-3AA	969.615	2.9 - 3	12.5	18
FONBC8-3.5AA	969.616	3.4 - 3.5	12.5	18
FONBC8-4AA	969.617	3.9 - 4	12.5	18
FONBC8-4.5AA	969.618	4.4 - 4.5	12.5	18
FONBC8-5AA	969.619	4.9 - 5	12.5	18
FONBC8-5.5AA	969.620	5.4 - 5.5	12.5	18
FONBC8-6AA	969.621	5.9 - 6	12.5	18
FONBC8-6.5AA	969.622	6.4 - 6.5	12.5	18
FONBC8-7AA	969.623	6.9 - 7	12.5	18
FONBC8-7.5AA	969.624	7.4 - 7.5	12.5	18
FONBC8-8AA	969.625	7.9 - 8	12.5	18

1. * No collapsibility

MEGA10N / NBS10

Model	Order No.	Ød	ØA	B
FONBC10-3AA	969.627	2.9 - 3	16.5	27
FONBC10-3.5AA	969.628	3.4 - 3.5	16.5	27
FONBC10-4AA	969.629	3.9 - 4	16.5	27
FONBC10-4.5AA	969.630	4.4 - 4.5	16.5	27
FONBC10-5AA	969.631	4.9 - 5	16.5	27
FONBC10-5.5AA	969.632	5.4 - 5.5	16.5	27
FONBC10-6AA	969.633	5.9 - 6	16.5	27
FONBC10-6.5AA	969.634	6.4 - 6.5	16.5	27
FONBC10-7AA	969.635	6.9 - 7	16.5	27
FONBC10-7.5AA	969.636	7.4 - 7.5	16.5	27
FONBC10-8AA	969.637	7.9 - 8	16.5	27
FONBC10-8.5AA	969.638	8.4 - 8.5	16.5	27
FONBC10-9AA	969.639	8.9 - 9	16.5	27
FONBC10-9.5AA	969.640	9.4 - 9.5	16.5	27
FONBC10-10AA	969.641	9.9 - 10	16.5	27

MEGA13N / NBS13

Model	Order No.	Ød	ØA	B
FONBC13-3AA	969.643	3.00 *	20.5	31
FONBC13-3.5AA	969.644	3.4 - 3.5	20.5	31
FONBC13-4AA	969.645	3.9 - 4	20.5	31
FONBC13-4.5AA	969.646	4.4 - 4.5	20.5	31
FONBC13-5AA	969.647	4.9 - 5	20.5	31
FONBC13-5.5AA	969.648	5.4 - 5.5	20.5	31
FONBC13-6AA	969.649	5.9 - 6	20.5	31
FONBC13-6.5AA	969.650	6.4 - 6.5	20.5	31
FONBC13-7AA	969.651	6.9 - 7	20.5	31
FONBC13-7.5AA	969.652	7.4 - 7.5	20.5	31
FONBC13-8AA	969.653	7.9 - 8	20.5	31
FONBC13-8.5AA	969.654	8.4 - 8.5	20.5	31
FONBC13-9AA	969.655	8.9 - 9	20.5	31
FONBC13-9.5AA	969.656	9.4 - 9.5	20.5	31
FONBC13-10AA	969.657	9.9 - 10	20.5	31
FONBC13-10.5AA	969.658	10.4 - 10.5	20.5	31
FONBC13-11AA	969.659	10.9 - 11	20.5	31
FONBC13-11.5AA	969.660	11.4 - 11.5	20.5	31
FONBC13-12AA	969.661	11.9 - 12	20.5	31
FONBC13-12.5AA	969.662	12.4 - 12.5	20.5	31
FONBC13-13AA	969.663	12.9 - 13	20.5	31

1. * No collapsibility

A.8

MEGA16N / NBS16

Model	Order No.	Ød	ØA	B
FONBC16-5AA	969.669	4.9 - 5	25.5	35
FONBC16-5.5AA	969.670	5.4 - 5.5	25.5	35
FONBC16-6AA	969.671	5.9 - 6	25.5	35
FONBC16-6.5AA	969.672	6.4 - 6.5	25.5	35
FONBC16-7AA	969.673	6.9 - 7	25.5	35
FONBC16-7.5AA	969.674	7.4 - 7.5	25.5	35
FONBC16-8AA	969.675	7.9 - 8	25.5	35
FONBC16-8.5AA	969.676	8.4 - 8.5	25.5	35
FONBC16-9AA	969.677	8.9 - 9	25.5	35
FONBC16-9.5AA	969.678	9.4 - 9.5	25.5	35
FONBC16-10AA	969.679	9.9 - 10	25.5	35
FONBC16-10.5AA	969.680	10.4 - 10.5	25.5	35
FONBC16-11AA	969.681	10.9 - 11	25.5	35
FONBC16-11.5AA	969.682	11.4 - 11.5	25.5	35
FONBC16-12AA	969.683	11.9 - 12	25.5	35
FONBC16-12.5AA	969.684	12.4 - 12.5	25.5	35
FONBC16-13AA	969.685	12.9 - 13	25.5	35
FONBC16-13.5AA	969.686	13.4 - 13.5	25.5	35
FONBC16-14AA	969.687	13.9 - 14	25.5	35
FONBC16-14.5AA	969.688	14.4 - 14.5	25.5	35
FONBC16-15AA	969.689	14.9 - 15	25.5	35
FONBC16-15.5AA	969.690	15.4 - 15.5	25.5	35
FONBC16-16AA	969.691	15.9 - 16	25.5	35

MEGA20N / NBS20

Model	Order No.	Ød	ØA	B
FONBC20-5AA	969.697	4.9 - 5	28.5	38
FONBC20-5.5AA	969.698	5.4 - 5.5	28.5	38
FONBC20-6AA	969.699	5.9 - 6	28.5	38
FONBC20-6.5AA	969.700	6.4 - 6.5	28.5	38
FONBC20-7AA	969.701	6.9 - 7	28.5	38
FONBC20-7.5AA	969.702	7.4 - 7.5	28.5	38
FONBC20-8AA	969.703	7.9 - 8	28.5	38
FONBC20-8.5AA	969.704	8.4 - 8.5	28.5	38
FONBC20-9AA	969.705	8.9 - 9	28.5	38
FONBC20-9.5AA	969.706	9.4 - 9.5	28.5	38
FONBC20-10AA	969.707	9.9 - 10	28.5	38
FONBC20-10.5AA	969.708	10.4 - 10.5	28.5	38
FONBC20-11AA	969.709	10.9 - 11	28.5	38
FONBC20-11.5AA	969.710	11.4 - 11.5	28.5	38
FONBC20-12AA	969.711	11.9 - 12	28.5	38
FONBC20-12.5AA	969.712	12.4 - 12.5	28.5	38
FONBC20-13AA	969.713	12.9 - 13	28.5	38
FONBC20-13.5AA	969.714	13.4 - 13.5	28.5	38
FONBC20-14AA	969.715	13.9 - 14	28.5	38
FONBC20-14.5AA	969.716	14.4 - 14.5	28.5	38
FONBC20-15AA	969.717	14.9 - 15	28.5	38
FONBC20-15.5AA	969.718	15.4 - 15.5	28.5	38
FONBC20-16AA	969.719	15.9 - 16	28.5	38
FONBC20-16.5AA	969.720	16.4 - 16.5	28.5	38
FONBC20-17AA	969.721	16.9 - 17	28.5	38
FONBC20-17.5AA	969.722	17.4 - 17.5	28.5	38
FONBC20-18AA	969.723	17.9 - 18	28.5	38
FONBC20-18.5AA	969.724	18.4 - 18.5	28.5	38
FONBC20-19AA	969.725	18.9 - 19	28.5	38
FONBC20-19.5AA	969.726	19.4 - 19.5	28.5	38
FONBC20-20AA	969.727	19.9 - 20	28.5	38

For New Baby Chuck use the standard NBN nut.

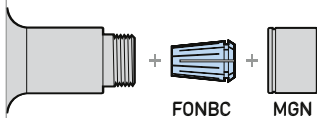

For MEGA New Baby Chuck use the standard MGN nut.

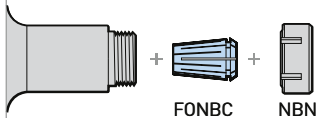

Note

Collapsibility is different from standard NBC collet.

MEGA25N

Model	Order No.	Ød	ØA	B
FONBC25-16AA	806.412	15.9 - 16	35.5	52
FONBC25-17AA	806.413	16.9 - 17	35.5	52
FONBC25-18AA	806.414	17.9 - 18	35.5	52
FONBC25-19AA	806.415	18.9 - 19	35.5	52
FONBC25-20AA	806.416	19.9 - 20	35.5	52
FONBC25-21AA	806.417	20.9 - 21	35.5	52
FONBC25-22AA	806.418	21.9 - 22	35.5	52
FONBC25-23AA	806.419	22.9 - 23	35.5	52
FONBC25-24AA	806.420	23.9 - 24	35.5	52
FONBC25-25AA	806.421	24.9 - 25	35.5	52
FONBC25-25.4AA	806.739	25.3 - 25.4	35.5	52

New Baby Collet Sets

For MEGA New Baby Chuck and New Baby Chuck.
Contains all the major collet models to cover entire clamping range.



Model	Order No.	Ød	Number of Collet	Size	Collet Model
SNBC6AA-22	802.187	0.5 - 6	22	200 x 170 x 50	MEGA6N / NBS6
SNBC8AA-20	802.188	0.5 - 8	20	200 x 170 x 50	MEGA8N / NBS8
SNBC10AA-20	802.183	1.5 - 10	20	200 x 170 x 50	MEG106N / NBS10
SNBC13AA-21	802.184	2.5 - 13	21	245 x 210 x 60	MEGA13N / NBS13
SNBC16AA-27	802.185	2.5 - 16	27	275 x 230 x 65	MEGA16N / NBS16
SNBC20AA-35	961.676	2.5 - 20	35	310 x 260 x 75	MEGA20N / NBS20
SNBC25AA-19	806.656	15.5 - 25	19	310 x 260 x 75	MEGA25N

1. Collets included in a set are shown in page 327 - 329.

Cases for New Baby Collets

Exclusive case to protect and maintain the high precision collets.



Model	Order No.	Number of Holes	Size	Collet Model
NBB6	961.524	60	200 x 170 x 50	NBC6 / FONBC6
NBB8	961.547	50	200 x 170 x 50	NBC8 / FONBC8
NBB10	961.569	40	200 x 170 x 50	NBC10 / FONBC10
NBB13	961.595	35	245 x 210 x 60	NBC13 / FONBC13
NBB16	961.629	35	275 x 230 x 65	NBC16 / FONBC16
NBB20	961.677	45	310 x 260 x 75	NBC20 / FONBC20
NBB25	806.657	28	310 x 260 x 75	NBC25 / FONBC25

1. All cases can not be used with new baby collet for endmill (NBC-E).

Collet Ejectors

Easily and quickly remove New Baby Collet from MEGA nuts and New Baby Nut.



Model	Order No.	Nut Model	Collet Model
NBC6-CE	969.492	MGN6 / NBN6	NBC6 / FONBC6
NBC6E-CE	969.496	MGN6 / NBN6	NBC6E
NBC8-CE	969.493	MGN8 / NBN8	NBC8 / FONBC8
NBC8E-CE	969.497	MGN8 / NBN8	NBC8E
NBC10-CE	969.494	MGN10 / NBN10	NBC10 / FONBC10
NBC10E-CE	969.498	MGN10 / NBN10	NBC10E
NBC13-CE	969.495	MGN13 / NBN13	NBC13 / FONBC13
NBC13E-CE	969.499	MGN13 / NBN13	NBC13E



Collet Removers

For MEGA New Baby Chuck, New Baby Chuck and MEGA ER Chuck.



Model	Order No.
NBJ	969.491

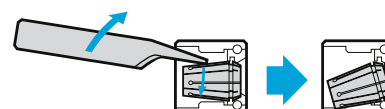

MEGA Nuts

For MEGA New Baby Chuck

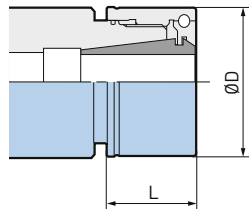
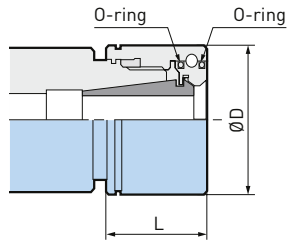

Standard Type

Model	Order No.	ØD	L	Body
MGN6	969.483	20	20.5	MEGA6N
MGN8	969.484	25	23	MEGA8N
MGN10	969.485	30	24	MEGA10N
MGN13	969.486	35	27	MEGA13N
MGN16	969.487	42	27	MEGA16N
MGN20	969.488	46	27	MEGA20N
MGN25	806.388	60	31	MEGA25N

Flat Type

Model	Order No.	ØD	L	Body
MGN 6F	805.668	20	18	MEGA6N
MGN 8F	805.669	25	20	MEGA8N
MGN 10F	805.670	30	21	MEGA10N
MGN 13F	805.671	35	24	MEGA13N
MGN 16F	805.672	42	24.5	MEGA16N
MGN 20F	805.673	46	24.5	MEGA20N

A.8

New Baby Nuts

For New Baby Chuck

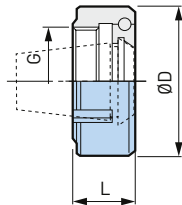

Model	Order No.	ØD	L	G	Body
NBN6	961.526	20	9.5	M12 P1	NBS6
NBN8	961.549	25	11	M16 P1	NBS8
NBN10	961.571	30	12.5	M21 P1	NBS10
NBN13	961.597	35	16	M26 P1	NBS13
NBN16	961.631	42	16	M32 P1	NBS16
NBN20	961.679	46	16	M36 P1	NBS20

O-Ring Set

For MEGA New Baby Chuck
Set includes 2 pieces.

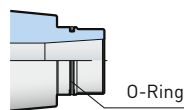

Model	Order No.
MG6NOR-2P	978.917
MG8NOR-2P	801.398
MG10NOR-2P	978.319
MG13NOR-2P	978.915

Model	Order No.
MG16NOR-2P	801.395
MG20NOR-2P	978.916
MG25NOR-2P	806.840

Adjusting Screws NBA

For MEGA New Baby Chuck, MEGA E Chuck, New Baby Chuck and MEGA ER Grip

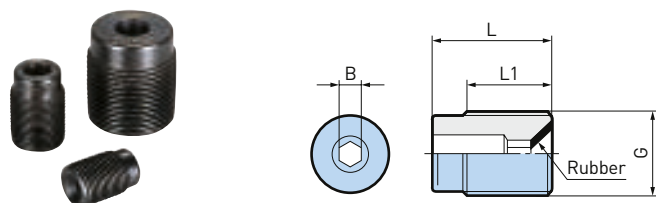

Model	Order No.	G	L	L1	SW	Body
NBA6B	961.527	M7	12	10	2	MEGA6N / MEGA6E / NBS6 / MEGA ER11
NBA8B	961.550	M9	13	10	2.5	MEGA8N / MEGA8E / NBS8
NBA10B	961.572	M11	16	12	3	MEGA10N / MEGA10E / NBS10 / MEGA ER16
NBA13B	961.598	M14	20	15	4	MEGA13N / MEGA13E / NBS13 / MEGA ER20
NBA16B	961.632	M18	20	15	4	MEGA16N / NBS16 / MEGA ER25
NBA20B	961.680	M21	20	15	4	MEGA20N / NBS20 / MEGA ER32
NBA25B	806.389	M27	20	15	4	MEGA25N

Tap Driving Back Stops

For New Baby Chuck
To suit synchronized tapping.

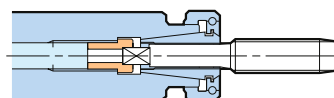
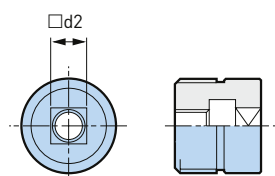

The square of the tap is positively located by fitting the tap driving back stop.

Model	Order No.	Tap Size l	d2	standard	Body
NBA10-M8	961.681	M8	5.0	JIS	NBS10
NBA10-M10	804.844	M10	5.5	JIS	NBS10

Model	Order No.	Tap Size l	d2	standard	Body
NBA13-M8DD	804.847	M8	6.2	DIN 371	NBS13
NBA13-M8	961.683	M8	5.0	JIS	NBS13
NBA13-M10	961.684	M10	5.5	JIS	NBS13
NBA13-M12D	961.685	M12	7.0	DIN 376	NBS13
NBA13-M12	804.845	M12	6.5	JIS	NBS13
NBA13-M14M10DD	804.846	M10 / M14	8.0	JIS / DIN 371	NBS13

Model	Order No.	Tap Size l	d2	standard	Body
NBA16-M10	804.848	M12	5.5	JIS	NBS16
NBA16-M12D	804.850	M12	7.0	DIN 376	NBS16
NBA16-M12	804.849	M12	6.5	JIS	NBS16
NBA16-M16	804.853	M16	10.0	JIS	NBS16
NBA16-M14M10DD	804.852	M10 / M14	8.0	JIS / DIN 371	NBS16
NBA16-M14DM16D	804.851	M14 / M16	9.0	DIN 376	NBS16

Model	Order No.	Tap Size l	d2	standard	Body
NBA20-M12D	804.855	M12	7.0	DIN 376	NBS20
NBA20-M12	804.854	M12	6.5	JIS	NBS20
NBA20-M14	804.856	M14	8.0	JIS	NBS20
NBA20-M16	804.858	M16	10.0	JIS	NBS20
NBA20-M14DM16D	804.857	M14 / M16	9.0	DIN 376	NBS20
NBA20-M20M20D	804.860	M20	12.0	JIS / DIN 376	NBS20

1. Synchronized tapping function is required on the machine.

MEGA Perfect Seals

For MEGA New Baby Chuck.

Unique design increases sealing performance with higher coolant pressure to create a "perfect seal". Remove the PS Ring, to supply coolant to the cutting tool periphery.

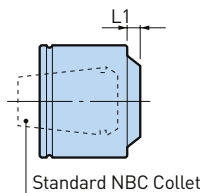

2way coolant

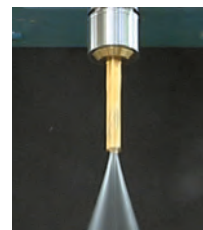

Through tools with PS ring



Jet through without PS ring

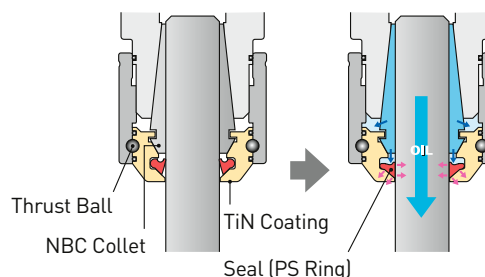

A.8

Model	Order No.	Cutting shank ø	L1	Collet Model
MPS6-03035	961.401	3 - 3.5	2.3	NBC6 -3 -3.75
MPS6-0304	969.861	3 - 4	2.3	NBC6 -3 -4.25
MPS6-04045	961.402	4 - 4.5	2.3	NBC6 -4 -4.75
MPS6-0405	969.862	4 - 5	2.3	NBC6 -4 -5.25
MPS6-05055	961.403	5 - 5.5	2.3	NBC6 -5 -5.75
MPS6-0506	969.863	5 - 6	2.3	NBC6 -5 -6
MPS8-03035	961.404	3 - 3.5	3.9	NBC8 -3 -4
MPS8-0304	969.864	3 - 4	3.9	NBC8 -3 -4.5
MPS8-04045	961.405	4 - 4.5	3.9	NBC8 -4 -5
MPS8-0405	969.865	4 - 5	3.9	NBC8 -4 -5.5
MPS8-05055	961.406	5 - 5.5	3.9	NBC8 -5 -6
MPS8-0506	969.866	5 - 6	3.9	NBC8 -5 -6.5
MPS8-06065	961.407	6 - 6.5	3.4	NBC8 -6 -7
MPS8-0607	969.867	6 - 7	3.4	NBC8 -6 -7.5
MPS8-07075	961.408	7 - 7.5	3.4	NBC8 -7 -8
MPS8-0708	969.868	7 - 8	3.4	NBC8 -7 -8
MPS10-03035	801.524	3 - 3.5	3.9	NBC10 -3 -4
MPS10-0304	969.869	3 - 4	3.9	NBC10 -3 -4.5
MPS10-04045	801.525	4 - 4.5	3.9	NBC10 -4 -5
MPS10-0405	969.870	4 - 5	3.9	NBC10 -4 -5.5
MPS10-05055	801.526	5 - 5.5	3.9	NBC10 -5 -6
MPS10-0506	969.871	5 - 6	3.9	NBC10 -5 -6.5
MPS10-06065	979.986	6 - 6.5	4.3	NBC10 -6 -7
MPS10-0607	969.872	6 - 7	4.3	NBC10 -6 -7.5
MPS10-07075	801.527	7 - 7.5	4.3	NBC10 -7 -8
MPS10-0708	969.873	7 - 8	4.3	NBC10 -7 -8.5
MPS10-08085	979.987	8 - 8.5	3.5	NBC10 -8 -9
MPS10-0809	969.874	8 - 9	3.5	NBC10 -8 -9.5
MPS10-09095	801.528	9 - 9.5	3.5	NBC10 -9 -10
MPS10-0910	969.875	9 - 10	3.5	NBC10 -9 -10

Model	Order No.	Cutting shank ø	L1	Collet Model
MPS13-03035	801.529	3 - 3.5	4.3	NBC13 -3 -4
MPS13-0304	969.876	3 - 4	4.3	NBC13 -3 -4.5
MPS13-04045	801.530	4 - 4.5	4.3	NBC13 -4 -5
MPS13-0405	969.877	4 - 5	4.3	NBC13 -4 -5.5
MPS13-05055	801.531	5 - 5.5	4.3	NBC13 -5 -6
MPS13-0506	969.878	5 - 6	4.3	NBC13 -5 -6.5
MPS13-06065	961.417	6 - 6.5	4.6	NBC13 -6 -7
MPS13-0607	969.879	6 - 7	4.6	NBC13 -6 -7.5
MPS13-07075	801.532	7 - 7.5	4.6	NBC13 -7 -8
MPS13-0708	969.880	7 - 8	4.6	NBC13 -7 -8.5
MPS13-08085	961.418	8 - 8.5	4.9	NBC13 -8 -9
MPS13-0809	969.881	8 - 9	4.9	NBC13 -8 -9.5
MPS13-09095	801.533	9 - 9.5	4.9	NBC13 -9 -10
MPS13-0910	969.882	9 - 10	4.9	NBC13 -9 -10.5
MPS13-10105	978.518	10 - 10.5	4.2	NBC13 -10 -11
MPS13-1011	969.883	10 - 11	4.2	NBC13 -10 -11.5
MPS13-11115	801.534	11 - 11.5	4.2	NBC13 -11 -12
MPS13-1112	969.884	11 - 12	4.2	NBC13 -11 -12.5
MPS13-12125	961.420	12 - 12.5	4.2	NBC13 -12 -13
MPS13-1213	969.885	12 - 13	4.2	NBC13 -12 -13

Model	Order No.	Cutting shank ø	L1	Collet Model
MPS16-03035	801.535	3 - 3.5	4	NBC16 -3 -4
MPS16-0304	969.886	3 - 4	4	NBC16 -3 -4.5
MPS16-04045	801.536	4 - 4.5	4	NBC16 -4 -5
MPS16-0405	969.887	4 - 5	4	NBC16 -4 -5.5
MPS16-05055	801.537	5 - 5.5	4	NBC16 -5 -6
MPS16-0506	969.888	5 - 6	4	NBC16 -5 -6.5
MPS16-06065	801.538	6 - 6.5	4.3	NBC16 -6 -7
MPS16-0607	969.889	6 - 7	4.3	NBC16 -6 -7.5
MPS16-07075	801.539	7 - 7.5	4.3	NBC16 -7 -8
MPS16-0708	969.890	7 - 8	4.3	NBC16 -7 -8.5
MPS16-08085	801.540	8 - 8.5	4.6	NBC16 -8 -9
MPS16-0809	969.891	8 - 9	4.6	NBC16 -8 -9.5
MPS16-09095	801.541	9 - 9.5	4.6	NBC16 -9 -10
MPS16-0910	969.892	9 - 10	4.6	NBC16 -9 -10.5
MPS16-10105	801.542	10 - 10.5	5.1	NBC16 -10 -11
MPS16-1011	969.893	10 - 11	5.1	NBC16 -10 -11.5
MPS16-11115	801.543	11 - 11.5	5.1	NBC16 -11 -12
MPS16-1112	969.894	11 - 12	5.1	NBC16 -11 -12.5
MPS16-12125	801.544	12 - 12.5	4.1	NBC16 -12 -13
MPS16-1213	969.895	12 - 13	4.1	NBC16 -12 -13.5
MPS16-1314	969.896	13 - 14	4.1	NBC16 -13 -14.5
MPS16-1415	969.897	14 - 15	4.1	NBC16 -14 -15.5
MPS16-1516	969.898	15 - 16	4.1	NBC16 -15 -16

Model	Order No.	Cutting shank ø	L1	Collet Model
MPS20-03035	978.504	3 - 3.5	4	NBC20 -3 -4
MPS20-0304	969.899	3 - 4	4	NBC20 -3 -4.5
MPS20-04045	801.545	4 - 4.5	4	NBC20 -4 -5
MPS20-0405	969.900	4 - 5	4	NBC20 -4 -5.5
MPS20-05055	801.546	5 - 5.5	4	NBC20 -5 -6
MPS20-0506	969.901	5 - 6	4	NBC20 -5 -6.5
MPS20-06065	801.547	6 - 6.5	4.3	NBC20 -6 -7
MPS20-0607	969.902	6 - 7	4.3	NBC20 -6 -7.5
MPS20-07075	801.548	7 - 7.5	4.3	NBC20 -7 -8
MPS20-0708	969.903	7 - 8	4.3	NBC20 -7 -8.5
MPS20-08085	801.549	8 - 8.5	4.6	NBC20 -8 -9
MPS20-0809	969.904	8 - 9	4.6	NBC20 -8 -9.5
MPS20-09095	801.550	9 - 9.5	4.6	NBC20 -9 -10
MPS20-0910	969.905	9 - 10	4.6	NBC20 -9 -10.5
MPS20-10105	801.551	10 - 10.5	5.1	NBC20 -10 -11
MPS20-1011	969.906	10 - 11	5.1	NBC20 -10 -11.5
MPS20-11115	801.552	11 - 11.5	5.1	NBC20 -11 -12
MPS20-1112	969.907	11 - 12	5.1	NBC20 -11 -12.5
MPS20-12125	978.512	12 - 12.5	5.1	NBC20 -12 -13
MPS20-1213	969.908	12 - 13	5.1	NBC20 -12 -13.5
MPS20-1314	969.909	13 - 14	5.2	NBC20 -13 -14.5
MPS20-1415	969.910	14 - 15	5.2	NBC20 -14 -15.5
MPS20-1516	969.911	15 - 16	5.2	NBC20 -15 -16.5
MPS20-1617	969.912	16 - 17	4.6	NBC20 -16 -17.5
MPS20-1718	969.913	17 - 18	4.6	NBC20 -17 -18.5
MPS20-1819	969.914	18 - 19	4.6	NBC20 -18 -19.5
MPS20-1920	969.915	19 - 20	4.6	NBC20 -19 -20

A.8

- 1 pce. of ps ring is included.
- To supply coolant to the periphery of the cutting tool, adjusting screw should not be mounted.

PS Rings

Replaceable seal is installed in the MEGA perfect seal.
One replacement seal is included in delivery.



Model	Order No.	Suitable for model
PS-0304	969.981	MPS / BPS -03035, 0304 / EPS -03, 04 / MERPS -030035, 035040
PS-0405	969.982	MPS / BPS -04045, 0405 / EPS -05 / MERPS -040045, 045050
PS-0506	969.983	MPS / BPS -05055, 0506 / EPS -06 / MERPS -050055, 055060
PS-0607	969.984	MPS / BPS -06065, 0607 / EPS -07 / MERPS -060065, 065070
PS-0708	969.985	MPS / BPS -07075, 0708 / EPS -08 / MERPS -070075, 075080
PS-0809	969.986	MPS / BPS -08085, 0809 / EPS -09 / MERPS -080085, 085090
PS-0910	969.987	MPS / BPS -09095, 0910 / EPS -10 / MERPS -090095, 095100
PS-1011	969.988	MPS / BPS -10105, 1011 / EPS -11 / MERPS -10105, 105110
PS-1112	969.989	MPS / BPS -11115, 1112 / EPS -12 / MERPS -110115, 115120
PS-1213	969.990	MPS / BPS -12125, 1213 / MERPS -120125, 125130
PS-1314	969.991	MPS / BPS -1314 / MERPS -130140
PS-1415	969.992	MPS / BPS -1415 / MERPS -140150
PS-1516	969.993	MPS / BPS -1516 / MERPS -150160
PS-1617	969.994	MPS / BPS -1617 / MERPS -160170
PS-1718	969.995	MPS / BPS -1718 / MERPS -170180
PS-1819	969.996	MPS / BPS -1819 / MERPS -180190
PS-1920	969.997	MPS / BPS -1920 / MERPS -190200

- 1 package contains 5 pcs. (1 size).

Baby Perfect Seals

For New Baby Chuck.

Unique design increases sealing performance with higher coolant pressure to create a "perfect seal". Remove the PS Ring, to supply coolant to the cutting tool periphery.

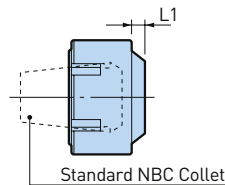

2way coolant

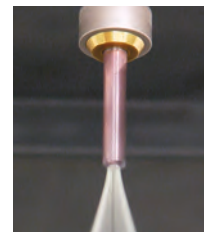

Through tools with PS ring



Jet through without PS ring

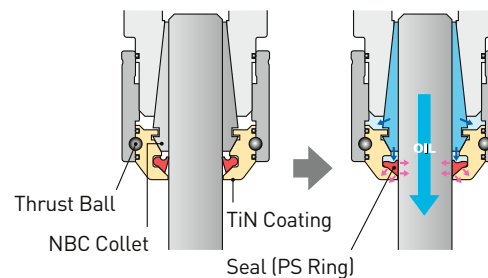

A.8

Model	Order No.	Cutting shank ø	L1	Collet Model
BPS6-03035	961.409	3 - 3.5	2.3	NBC6 -3 -3.75
BPS6-0304	969.921	3 - 4	2.3	NBC6 -3 -4.25
BPS6-04045	961.410	4 - 4.5	2.3	NBC6 -4 -4.75
BPS6-0405	969.922	4 - 5	2.3	NBC6 -4 -5.25
BPS6-05055	961.411	5 - 5.5	2.3	NBC6 -5 -5.75
BPS6-0506	969.923	5 - 6	2.3	NBC6 -5 -6
BPS8-03035	961.412	3 - 3.5	3.9	NBC8 -3 -4
BPS8-0304	969.924	3 - 4	3.9	NBC8 -3 -4.5
BPS8-04045	961.413	4 - 4.5	3.9	NBC8 -4 -5
BPS8-0405	969.925	4 - 5	3.9	NBC8 -4 -5.5
BPS8-05055	961.414	5 - 5.5	3.9	NBC8 -5 -6
BPS8-0506	969.926	5 - 6	3.9	NBC8 -5 -6.5
BPS8-06065	961.415	6 - 6.5	3.4	NBC8 -6 -7
BPS8-0607	969.927	6 - 7	3.4	NBC8 -6 -7.5
BPS8-07075	961.416	7 - 7.5	3.4	NBC8 -7 -8
BPS8-0708	969.928	7 - 8	3.4	NBC8 -7 -8
BPS10-03035	800.403	3 - 3.5	3.9	NBC10 -3 -4
BPS10-0304	969.929	3 - 4	3.9	NBC10 -3 -4.5
BPS10-04045	800.404	4 - 4.5	3.9	NBC10 -4 -5
BPS10-0405	969.930	4 - 5	3.9	NBC10 -4 -5.5
BPS10-05055	800.405	5 - 5.5	3.9	NBC10 -5 -6
BPS10-0506	969.931	5 - 6	3.9	NBC10 -5 -6.5
BPS10-06065	800.406	6 - 6.5	4.3	NBC10 -6 -7
BPS10-0607	969.932	6 - 7	4.3	NBC10 -6 -7.5
BPS10-07075	800.407	7 - 7.5	4.3	NBC10 -7 -8
BPS10-0708	969.933	7 - 8	4.3	NBC10 -7 -8.5
BPS10-08085	800.408	8 - 8.5	3.5	NBC10 -8 -9
BPS10-0809	969.934	8 - 9	3.5	NBC10 -8 -9.5
BPS10-09095	800.409	9 - 9.5	3.5	NBC10 -9 -10
BPS10-0910	969.935	9 - 10	3.5	NBC10 -9 -10

Model	Order No.	Cutting shank ø	L1	Collet Model
BPS13-03035	800.410	3 - 3.5	4.3	NBC13 -3 -4
BPS13-0304	969.936	3 - 4	4.3	NBC13 -3 -4.5
BPS13-04045	800.411	4 - 4.5	4.3	NBC13 -4 -5
BPS13-0405	969.937	4 - 5	4.3	NBC13 -4 -5.5
BPS13-05055	800.412	5 - 5.5	4.3	NBC13 -5 -6
BPS13-0506	969.938	5 - 6	4.3	NBC13 -5 -6.5
BPS13-06065	800.413	6 - 6.5	4.6	NBC13 -6 -7
BPS13-0607	969.939	6 - 7	4.6	NBC13 -6 -7.5
BPS13-07075	800.414	7 - 7.5	4.6	NBC13 -7 -8
BPS13-0708	969.940	7 - 8	4.6	NBC13 -7 -8.5
BPS13-08085	800.415	8 - 8.5	4.9	NBC13 -8 -9
BPS13-0809	969.941	8 - 9	4.9	NBC13 -8 -9.5
BPS13-09095	800.416	9 - 9.5	4.9	NBC13 -9 -10
BPS13-0910	969.942	9 - 10	4.9	NBC13 -9 -10.5
BPS13-10105	800.417	10 - 10.5	4.2	NBC13 -10 -11
BPS13-1011	969.943	10 - 11	4.2	NBC13 -10 -11.5
BPS13-11115	800.418	11 - 11.5	4.2	NBC13 -11 -12
BPS13-1112	969.944	11 - 12	4.2	NBC13 -11 -12.5
BPS13-12125	800.419	12 - 12.5	4.2	NBC13 -12 -13
BPS13-1213	969.945	12 - 13	4.2	NBC13 -12 -13

Model	Order No.	Cutting shank ϕ	L1	Collet Model
BPS16-03035	800.420	3 - 3.5	4	NBC16 -3 -4
BPS16-0304	969.946	3 - 4	4	NBC16 -3 -4.5
BPS16-04045	800.421	4 - 4.5	4	NBC16 -4 -5
BPS16-0405	969.947	4 - 5	4	NBC16 -4 -5.5
BPS16-05055	800.422	5 - 5.5	4	NBC16 -5 -6
BPS16-0506	969.948	5 - 6	4	NBC16 -5 -6.5
BPS16-06065	800.423	6 - 6.5	4.3	NBC16 -6 -7
BPS16-0607	969.949	6 - 7	4.3	NBC16 -6 -7.5
BPS16-07075	800.424	7 - 7.5	4.3	NBC16 -7 -8
BPS16-0708	969.950	7 - 8	4.3	NBC16 -7 -8.5
BPS16-08085	800.425	8 - 8.5	4.6	NBC16 -8 -9
BPS16-0809	969.951	8 - 9	4.6	NBC16 -8 -9.5
BPS16-09095	800.426	9 - 9.5	4.6	NBC16 -9 -10
BPS16-0910	969.952	9 - 10	4.6	NBC16 -9 -10.5
BPS16-10105	800.427	10 - 10.5	5.1	NBC16 -10 -11
BPS16-1011	969.953	10 - 11	5.1	NBC16 -10 -11.5
BPS16-11115	800.428	11 - 11.5	5.1	NBC16 -11 -12
BPS16-1112	969.954	11 - 12	5.1	NBC16 -11 -12.5
BPS16-12125	800.429	12 - 12.5	4.1	NBC16 -12 -13
BPS16-1213	969.955	12 - 13	4.1	NBC16 -12 -13.5
BPS16-1314	969.956	13 - 14	4.1	NBC16 -13 -14.5
BPS16-1415	969.957	14 - 15	4.1	NBC16 -14 -15.5
BPS16-1516	969.958	15 - 16	4.1	NBC16 -15 -16

Model	Order No.	Cutting shank ϕ	L1	Collet Model
BPS20-03035	800.430	3 - 3.5	4	NBC20 -3 -4
BPS20-0304	969.959	3 - 4	4	NBC20 -3 -4.5
BPS20-04045	800.431	4 - 4.5	4	NBC20 -4 -5
BPS20-0405	969.960	4 - 5	4	NBC20 -4 -5.5
BPS20-05055	800.432	5 - 5.5	4	NBC20 -5 -6
BPS20-0506	969.961	5 - 6	4	NBC20 -5 -6.5
BPS20-06065	800.433	6 - 6.5	4.3	NBC20 -6 -7
BPS20-0607	969.962	6 - 7	4.3	NBC20 -6 -7.5
BPS20-07075	800.434	7 - 7.5	4.3	NBC20 -7 -8
BPS20-0708	969.963	7 - 8	4.3	NBC20 -7 -8.5
BPS20-08085	800.435	8 - 8.5	4.6	NBC20 -8 -9
BPS20-0809	969.964	8 - 9	4.6	NBC20 -8 -9.5
BPS20-09095	800.436	9 - 9.5	4.6	NBC20 -9 -10
BPS20-0910	969.965	9 - 10	4.6	NBC20 -9 -10.5
BPS20-10105	800.437	10 - 10.5	5.1	NBC20 -10 -11
BPS20-1011	969.966	10 - 11	5.1	NBC20 -10 -11.5
BPS20-11115	800.438	11 - 11.5	5.1	NBC20 -11 -12
BPS20-1112	969.967	11 - 12	5.1	NBC20 -11 -12.5
BPS20-12125	800.439	12 - 12.5	5.1	NBC20 -12 -13
BPS20-1213	969.968	12 - 13	5.1	NBC20 -12 -13.5
BPS20-1314	969.969	13 - 14	5.2	NBC20 -13 -14.5
BPS20-1415	969.970	14 - 15	5.2	NBC20 -14 -15.5
BPS20-1516	969.971	15 - 16	5.2	NBC20 -15 -16.5
BPS20-1617	969.972	16 - 17	4.6	NBC20 -16 -17.5
BPS20-1718	969.973	17 - 18	4.6	NBC20 -17 -18.5
BPS20-1819	969.974	18 - 19	4.6	NBC20 -18 -19.5
BPS20-1920	969.975	19 - 20	4.6	NBC20 -19 -20

A.8

1. 1 pce. of ps ring is included.
2. To supply coolant to the periphery of the cutting tool, adjusting screw should not be mounted.

Accessories & Spare Parts



MEGA E Collets

For MEGA E Chuck

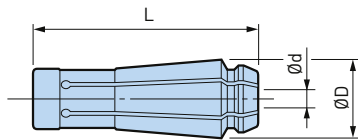

Collet class	Max. runout	
	At nose	4xD
AA	Within 1 µm	Within 3 µm

MEGA6E					
Model	Order No.	Ød	ØD	L	E
MEC6-3AA	968.421	3	11.3	34.9	19
MEC6-4AA	968.423	4	11.3	34.9	22
MEC6-5AA	968.424	5	11.3	34.9	25
MEC6-6AA	968.425	6	11.3	34.9	27

MEGA8E					
Model	Order No.	Ød	ØD	L	E
MEC8-3AA	968.427	3	14.1	39.4	19
MEC8-4AA	968.429	4	14.1	39.4	22
MEC8-5AA	968.430	5	14.1	39.4	25
MEC8-6AA	968.431	6	14.1	39.4	28
MEC8-7AA	801.317	7	14.1	39.4	29
MEC8-8AA	968.433	8	14.1	39.4	31

A.8

MEGA10E					
Model	Order No.	Ød	ØD	L	E
MEC10-3AA	968.434	3	17.1	45.7	19
MEC10-4AA	968.436	4	17.1	45.7	22
MEC10-5AA	968.437	5	17.1	45.7	25
MEC10-6AA	968.438	6	17.1	45.7	28
MEC10-7AA	801.313	7	17.1	45.7	29.5
MEC10-8AA	968.440	8	17.1	45.7	31
MEC10-9AA	801.314	9	17.1	45.7	33
MEC10-10AA	968.442	10	17.1	45.7	37

MEGA13E					
Model	Order No.	Ød	ØD	L	E
MEC13-3AA	968.443	3	20.6	47.9	19
MEC13-4AA	968.445	4	20.6	47.9	22
MEC13-5AA	968.446	5	20.6	47.9	25
MEC13-6AA	968.447	6	20.6	47.9	28
MEC13-7AA	968.448	7	20.6	47.9	29.5
MEC13-8AA	968.449	8	20.6	47.9	31
MEC13-9AA	801.316	9	20.6	47.9	33
MEC13-10AA	968.451	10	20.6	47.9	35
MEC13-11AA	801.315	11	20.6	47.9	37
MEC13-12AA	968.453	12	20.6	47.9	39

1. "E" is the min. clamping length.

MEGA E Nuts

For MEGA E Chuck

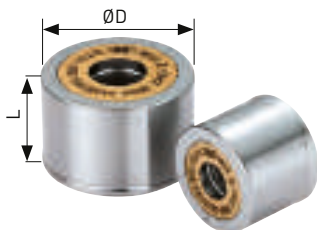

Model	Order No.	ØD	L	Body
MEN6	968.461	25	20.5	MEGA6E
MEN8	968.462	30	22	MEGA8E
MEN10	968.463	35	22.5	MEGA10E
MEN13	968.464	42	24.5	MEGA13E

O-Ring Set

For MEGA E Chuck
Set includes 2 pieces.

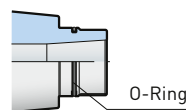

Model	Order No.
MG6EOR-2P	801.396
MG8EOR-2P	801.397
MG10EOR-2P	801.393
MG13EOR-2P	801.394

MEGA E Perfect Seals

For MEGA E Chuck

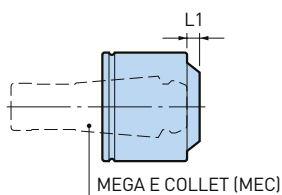

2way coolant



Through tools with PS ring



Jet through without PS ring

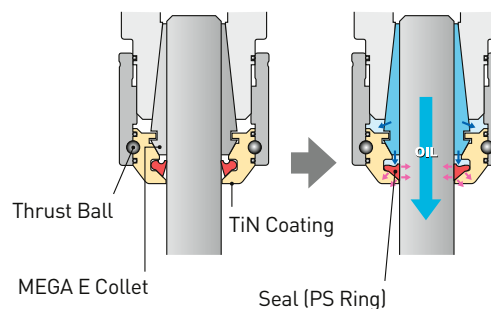

A.8

Model	Order No.	Cutting shank ø	L1	Collet Model
EPS6-03	968.468	3	5.6	MEC6 -3
EPS6-04	968.469	4	5.2	MEC6 -4
EPS6-05	968.470	5	5.2	MEC6 -5
EPS6-06	968.471	6	5.2	MEC6 -6
EPS8-03	968.472	3	6.4	MEC8 -3
EPS8-04	968.473	4	6	MEC8 -4
EPS8-05	968.474	5	6	MEC8 -5
EPS8-06	968.475	6	6	MEC8 -6
EPS8-07	968.476	7	5.6	MEC8 -7
EPS8-08	968.477	8	5.6	MEC8 -8
EPS10-03	968.478	3	6.4	MEC10 -3
EPS10-04	968.479	4	6	MEC10 -4
EPS10-05	968.480	5	6	MEC10 -5
EPS10-06	968.481	6	6	MEC10 -6
EPS10-07	968.482	7	6.3	MEC10 -7
EPS10-08	968.483	8	6.3	MEC10 -8
EPS10-09	968.484	9	5.7	MEC10 -9
EPS10-10	968.485	10	5.7	MEC10 -10

Model	Order No.	Cutting shank ø	L1	Collet Model
EPS13-03	968.486	3	6.4	MEC13 -3
EPS13-04	968.487	4	6	MEC13 -4
EPS13-05	968.488	5	6	MEC13 -5
EPS13-06	968.489	6	6	MEC13 -6
EPS13-07	968.490	7	6.3	MEC13 -7
EPS13-08	968.491	8	6.5	MEC13 -8
EPS13-09	968.492	9	6.5	MEC13 -9
EPS13-10	968.493	10	6.5	MEC13 -10
EPS13-11	968.494	11	6.2	MEC13 -11
EPS13-12	968.495	12	6.2	MEC13 -12

1. 1 pce. of ps ring is included.
2. To supply coolant to the periphery of the cutting tool, adjusting screw should not be mounted.

Accessories & Spare Parts



MEGA ER Collets

For MEGA ER Grip.
All ERC collets are inspected twice to guarantee high runout accuracy.

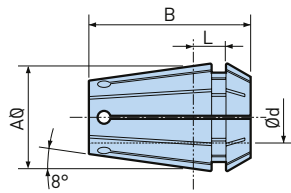

Collet class	Max. runout	
	At nose	4xD
AA	Within 1 µm	Within 3 µm

MEGA ER 11

Model	Order No.	Ød	ØA	L	B
ERC11-3AA	802.836	2.75 - 3	11	3.8	18
ERC11-3.25AA	802.837	3 - 3.25	11	3.8	18
ERC11-3.5AA	802.838	3.25 - 3.5	11	3.8	18
ERC11-3.75AA	802.839	3.5 - 3.75	11	3.8	18
ERC11-4AA	802.840	3.75 - 4	11	3.8	18
ERC11-4.25AA	802.841	4 - 4.25	11	3.8	18
ERC11-4.5AA	802.842	4.25 - 4.5	11	3.8	18
ERC11-4.75AA	802.843	4.5 - 4.75	11	3.8	18
ERC11-5AA	802.844	4.75 - 5	11	3.8	18
ERC11-5.25AA	802.845	5 - 5.25	11	3.8	18
ERC11-5.5AA	802.846	5.25 - 5.5	11	3.8	18
ERC11-5.75AA	802.847	5.5 - 5.75	11	3.8	18
ERC11-6AA	802.848	5.5 - 6	11	3.8	18

MEGA ER 16

Model	Order No.	Ød	ØA	L	B
ERC16-2AA	967.501	1.9 - 2	16	6.26	27.5
ERC16-2.1AA	967.502	2 - 2.1	16	6.26	27.5
ERC16-2.2AA	967.503	2.1 - 2.2	16	6.26	27.5
ERC16-2.3AA	967.504	2.2 - 2.3	16	6.26	27.5
ERC16-2.4AA	967.505	2.3 - 2.4	16	6.26	27.5
ERC16-2.5AA	967.506	2.4 - 2.5	16	6.26	27.5
ERC16-2.6AA	967.507	2.5 - 2.6	16	6.26	27.5
ERC16-2.7AA	967.508	2.6 - 2.7	16	6.26	27.5
ERC16-2.8AA	967.509	2.7 - 2.8	16	6.26	27.5
ERC16-2.9AA	967.510	2.8 - 2.9	16	6.26	27.5
ERC16-3AA	967.511	2.75 - 3	16	6.26	27.5
ERC16-3.25AA	967.512	3 - 3.25	16	6.26	27.5
ERC16-3.5AA	967.513	3.25 - 3.5	16	6.26	27.5
ERC16-3.75AA	967.514	3.5 - 3.75	16	6.26	27.5
ERC16-4AA	967.515	3.75 - 4	16	6.26	27.5
ERC16-4.25AA	967.516	4 - 4.25	16	6.26	27.5
ERC16-4.5AA	967.517	4.25 - 4.5	16	6.26	27.5
ERC16-4.75AA	967.518	4.5 - 4.75	16	6.26	27.5
ERC16-5AA	967.519	4.75 - 5	16	6.26	27.5
ERC16-5.25AA	967.520	5 - 5.25	16	6.26	27.5
ERC16-5.5AA	967.521	5.25 - 5.5	16	6.26	27.5
ERC16-5.75AA	967.522	5.5 - 5.75	16	6.26	27.5
ERC16-6AA	967.523	5.5 - 6	16	6.26	27.5
ERC16-6.5AA	967.524	6 - 6.5	16	6.26	27.5
ERC16-7AA	967.525	6.5 - 7	16	6.26	27.5
ERC16-7.5AA	967.526	7 - 7.5	16	6.26	27.5
ERC16-8AA	967.527	7.5 - 8	16	6.26	27.5
ERC16-8.5AA	967.528	8 - 8.5	16	6.26	27.5
ERC16-9AA	967.529	8.5 - 9	16	6.26	27.5
ERC16-9.5AA	967.530	9 - 9.5	16	6.26	27.5
ERC16-10AA	967.531	9.5 - 10	16	6.26	27.5

MEGA ER 20

Model	Order No.	Ød	ØA	L	B
ERC20-3AA	967.532	2.75 - 3	20	6.36	31.5
ERC20-3.25AA	967.533	3 - 3.25	20	6.36	31.5
ERC20-3.5AA	967.534	3.25 - 3.5	20	6.36	31.5
ERC20-3.75AA	967.535	3.5 - 3.75	20	6.36	31.5
ERC20-4AA	967.536	3.75 - 4	20	6.36	31.5
ERC20-4.25AA	967.537	4 - 4.25	20	6.36	31.5
ERC20-4.5AA	967.538	4.25 - 4.5	20	6.36	31.5
ERC20-4.75AA	967.539	4.5 - 4.75	20	6.36	31.5
ERC20-5AA	967.540	4.75 - 5	20	6.36	31.5
ERC20-5.25AA	967.541	5 - 5.25	20	6.36	31.5
ERC20-5.5AA	967.542	5.25 - 5.5	20	6.36	31.5
ERC20-5.75AA	967.543	5.5 - 5.75	20	6.36	31.5
ERC20-6AA	967.544	5.5 - 6	20	6.36	31.5
ERC20-6.5AA	967.545	6 - 6.5	20	6.36	31.5
ERC20-7AA	967.546	6.5 - 7	20	6.36	31.5
ERC20-7.5AA	967.547	7 - 7.5	20	6.36	31.5
ERC20-8AA	967.548	7.5 - 8	20	6.36	31.5
ERC20-8.5AA	967.549	8 - 8.5	20	6.36	31.5
ERC20-9AA	967.550	8.5 - 9	20	6.36	31.5
ERC20-9.5AA	967.551	9 - 9.5	20	6.36	31.5
ERC20-10AA	967.552	9.5 - 10	20	6.36	31.5
ERC20-10.5AA	967.553	10 - 10.5	20	6.36	31.5
ERC20-11AA	967.554	10.5 - 11	20	6.36	31.5
ERC20-11.5AA	967.555	11 - 11.5	20	6.36	31.5
ERC20-12AA	967.556	11.5 - 12	20	6.36	31.5
ERC20-12.5AA	967.557	12 - 12.5	20	6.36	31.5
ERC20-13AA	967.558	12.5 - 13	20	6.36	31.5

MEGA ER 25

Model	Order No.	Ød	ØA	L	B
ERC25-3AA	967.559	2.75 - 3	25	6.66	34
ERC25-3.25AA	967.560	3 - 3.25	25	6.66	34
ERC25-3.5AA	967.561	3.25 - 3.5	25	6.66	34
ERC25-3.75AA	967.562	3.5 - 3.75	25	6.66	34
ERC25-4AA	967.563	3.75 - 4	25	6.66	34
ERC25-4.25AA	967.564	4 - 4.25	25	6.66	34
ERC25-4.5AA	967.565	4.25 - 4.5	25	6.66	34
ERC25-4.75AA	967.566	4.5 - 4.75	25	6.66	34
ERC25-5AA	967.567	4.75 - 5	25	6.66	34
ERC25-5.25AA	967.568	5 - 5.25	25	6.66	34
ERC25-5.5AA	967.569	5.25 - 5.5	25	6.66	34
ERC25-5.75AA	967.570	5.5 - 5.75	25	6.66	34
ERC25-6AA	967.571	5.5 - 6	25	6.66	34
ERC25-6.5AA	967.572	6 - 6.5	25	6.66	34
ERC25-7AA	967.573	6.5 - 7	25	6.66	34
ERC25-7.5AA	967.574	7 - 7.5	25	6.66	34
ERC25-8AA	967.575	7.5 - 8	25	6.66	34
ERC25-8.5AA	967.576	8 - 8.5	25	6.66	34
ERC25-9AA	967.577	8.5 - 9	25	6.66	34
ERC25-9.5AA	967.578	9 - 9.5	25	6.66	34
ERC25-10AA	967.579	9.5 - 10	25	6.66	34
ERC25-10.5AA	967.580	10 - 10.5	25	6.66	34
ERC25-11AA	967.581	10.5 - 11	25	6.66	34
ERC25-11.5AA	967.582	11 - 11.5	25	6.66	34
ERC25-12AA	967.583	11.5 - 12	25	6.66	34
ERC25-12.5AA	967.584	12 - 12.5	25	6.66	34
ERC25-13AA	967.585	12.5 - 13	25	6.66	34
ERC25-13.5AA	967.586	13 - 13.5	25	6.66	34
ERC25-14AA	967.587	13.5 - 14	25	6.66	34
ERC25-14.5AA	967.588	14 - 14.5	25	6.66	34
ERC25-15AA	967.589	14.5 - 15	25	6.66	34
ERC25-15.5AA	967.590	15 - 15.5	25	6.66	34
ERC25-16AA	967.591	15.5 - 16	25	6.66	34

MEGA ER 32

Model	Order No.	Ød	ØA	L	B
ERC32-3AA	967.592	2.75 - 3	32	7.16	40
ERC32-3.25AA	967.593	3 - 3.25	32	7.16	40
ERC32-3.5AA	967.594	3.25 - 3.5	32	7.16	40
ERC32-3.75AA	967.595	3.5 - 3.75	32	7.16	40
ERC32-4AA	967.596	3.75 - 4	32	7.16	40
ERC32-4.25AA	967.597	4 - 4.25	32	7.16	40
ERC32-4.5AA	967.598	4.25 - 4.5	32	7.16	40
ERC32-4.75AA	967.599	4.5 - 4.75	32	7.16	40
ERC32-5AA	967.600	4.75 - 5	32	7.16	40
ERC32-5.25AA	967.601	5 - 5.25	32	7.16	40
ERC32-5.5AA	967.602	5.25 - 5.5	32	7.16	40
ERC32-5.75AA	967.603	5.5 - 5.75	32	7.16	40
ERC32-6AA	967.604	5.5 - 6	32	7.16	40
ERC32-6.5AA	967.605	6 - 6.5	32	7.16	40
ERC32-7AA	967.606	6.5 - 7	32	7.16	40
ERC32-7.5AA	967.607	7 - 7.5	32	7.16	40
ERC32-8AA	967.608	7.5 - 8	32	7.16	40
ERC32-8.5AA	967.609	8 - 8.5	32	7.16	40
ERC32-9AA	967.610	8.5 - 9	32	7.16	40
ERC32-9.5AA	967.611	9 - 9.5	32	7.16	40
ERC32-10AA	967.612	9.5 - 10	32	7.16	40
ERC32-10.5AA	967.613	10 - 10.5	32	7.16	40
ERC32-11AA	967.614	10.5 - 11	32	7.16	40
ERC32-11.5AA	967.615	11 - 11.5	32	7.16	40
ERC32-12AA	967.616	11.5 - 12	32	7.16	40
ERC32-12.5AA	967.617	12 - 12.5	32	7.16	40
ERC32-13AA	967.618	12.5 - 13	32	7.16	40
ERC32-13.5AA	967.619	13 - 13.5	32	7.16	40
ERC32-14AA	967.620	13.5 - 14	32	7.16	40
ERC32-14.5AA	967.621	14 - 14.5	32	7.16	40
ERC32-15AA	967.622	14.5 - 15	32	7.16	40
ERC32-15.5AA	967.623	15 - 15.5	32	7.16	40
ERC32-16AA	967.624	15.5 - 16	32	7.16	40
ERC32-16.5AA	967.625	16 - 16.5	32	7.16	40
ERC32-17AA	801.013	16.5 - 17	32	7.16	40
ERC32-17.5AA	967.627	17 - 17.5	32	7.16	40
ERC32-18AA	967.628	17.5 - 18	32	7.16	40
ERC32-18.5AA	967.629	18 - 18.5	32	7.16	40
ERC32-19AA	967.630	18.5 - 19	32	7.16	40
ERC32-19.5AA	967.631	19 - 19.5	32	7.16	40
ERC32-20AA	967.632	19.5 - 20	32	7.16	40

A.8

Collet Removers

For MEGA New Baby Chuck, New Baby Chuck and MEGA ER Chuck.



Model	Order No.
NBJ	969.491

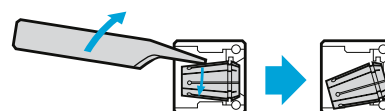

MEGA ER Nut

For MEGA ER Grip.
High precision nut with ball bearing ensure outstanding runout repeatability.

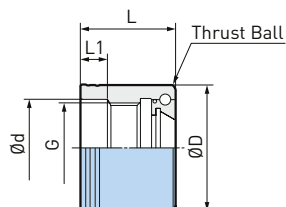

Model	Order No.	Ød	ØD	L	L1	G	Body	Wrench
MERN16	967.801	23	30	25	7.5	M22 P1.5	MEGA ER 16	MGR30L
MERN20	967.802	27	35	26.5	7.5	M25 P1.5	MEGA ER 20	MGR35L
MERN25	967.803	33.5	42	27.5	7.5	M32 P1.5	MEGA ER 25	MGR42L
MERN32	967.804	41	50	30.2	7.7	M40 P1.5	MEGA ER 32	MGR50L

1. MEGA ER nut can not be used with some of conventional ER chuck. Please check dimensions carefully in that case.
2. To maximize the cutting performance, using with MEGA ER grip is recommended.

MEGA ER Solid Nut

A.8

For MEGA ER Grip.
Free-notch design nut for high speed machining.

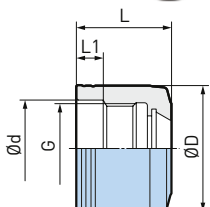

Model	Order No.	Ød	ØD	L	L1	G	Body	Wrench
MER16SN	805.663	23	30	25	7.5	M22 P1.5	MEGA ER 16	MGR30L
MER20SN	805.664	27	35	26.5	7.5	M25 P1.5	MEGA ER 20	MGR35L
MER25SN	805.665	33.5	42	27.5	7.5	M32 P1.5	MEGA ER 25	MGR42L
MER32SN	805.666	41	50	30.2	7.7	M40 P1.5	MEGA ER 32	MGR50L

1. MEGA ER nut can not be used with some of conventional ER chuck. Please check dimensions carefully in that case.
2. To maximize the cutting performance, using with MEGA ER grip is recommended.

ER Nuts

For MEGA ER Grip.
Conventional ER Nut.

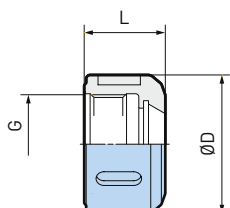

Model	Order No.	ØD	L	G	Body	Wrench
ERN11	803.581	19	12.3	M14 0.75	MEGA ER 11	NBK6
ERN16	803.582	30	19	M22 P1.5	MEGA ER 16	NBK10
ERN20	803.583	35	20.5	M25 P1.5	MEGA ER 20	NBK13
ERN25	803.584	42	21.5	M32 P1.5	MEGA ER 25	NBK16
ERN32	803.585	50	24	M40 P1.5	MEGA ER 32	FK45-50L

MEGA ER Perfect Seal

For MEGA ER Grip

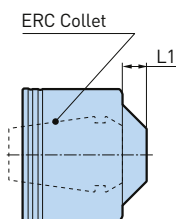

2way coolant

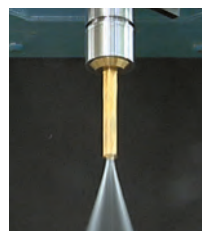

Through tools
with PS ring



Jet through without
PS ring

Model	Order No.	Cutting shank ø	L1	Collet Model	Body
MERPS16-030035	967.850	3 - 3.5	6.4	ERC16 -3 -3.75	MEGA ER 16
MERPS16-035040	967.851	3.5 - 4	6.4	ERC16 -3.5-4.75	MEGA ER 16
MERPS16-040045	967.852	4 - 4.5	6.4	ERC16 -4 -4.75	MEGA ER 16
MERPS16-045050	967.853	4.5 - 5	6.4	ERC16 -4.5 -5.25	MEGA ER 16
MERPS16-050055	967.854	5 - 5.5	6.4	ERC16 -5 -6	MEGA ER 16
MERPS16-055060	967.855	5.5 - 6	6.4	ERC16 -5.5-6.5	MEGA ER 16
MERPS16-060065	967.856	6 - 6.5	6.8	ERC16 -6 -7	MEGA ER 16
MERPS16-065070	967.857	6.5 - 7	6.8	ERC16 -6.5 -7.5	MEGA ER 16
MERPS16-070075	967.858	7 - 7.5	6.8	ERC16 -7 -8	MEGA ER 16
MERPS16-075080	967.859	7.5 - 8	6.8	ERC16 -7.5 -8.5	MEGA ER 16
MERPS16-080085	967.861	8 - 8.5	6.1	ERC16 -8 -9	MEGA ER 16
MERPS16-085090	967.862	8.5 - 9	6.1	ERC16 -8.5 -9.5	MEGA ER 16
MERPS16-090095	967.863	9 - 9.5	6.1	ERC16 -9 -10	MEGA ER 16
MERPS16-095100	967.864	9.5 - 10	6.1	ERC16 -9.5 -10	MEGA ER 16
MERPS20-030035	967.865	3 - 3.5	6.4	ERC20 -3 -3.75	MEGA ER 20
MERPS20-035040	967.866	3.5 - 4	6.4	ERC20 -3.5-4.75	MEGA ER 20
MERPS20-040045	967.867	4 - 4.5	6.4	ERC20 -4 -4.75	MEGA ER 20
MERPS20-045050	967.868	4.5 - 5	6.4	ERC20 -4.5 -5.25	MEGA ER 20
MERPS20-050055	967.869	5 - 5.5	6.4	ERC20 -5 -6	MEGA ER 20
MERPS20-055060	967.870	5.5 - 6	6.4	ERC20 -5.5-6.5	MEGA ER 20
MERPS20-060065	967.871	6 - 6.5	6.8	ERC20 -6 -7	MEGA ER 20
MERPS20-065070	967.872	6.5 - 7	6.8	ERC20 -6.5 -7.5	MEGA ER 20
MERPS20-070075	967.873	7 - 7.5	6.8	ERC20 -7 -8	MEGA ER 20
MERPS20-075080	967.874	7.5 - 8	6.8	ERC20 -7.5 -8.5	MEGA ER 20
MERPS20-080085	967.875	8 - 8.5	6.9	ERC20 -8 -9	MEGA ER 20
MERPS20-085090	967.876	8.5 - 9	6.9	ERC20 -8.5 -9.5	MEGA ER 20
MERPS20-090095	967.877	9 - 9.5	6.9	ERC20 -9 -10	MEGA ER 20
MERPS20-095100	967.878	9.5 - 10	6.9	ERC20 -9.5 -10.5	MEGA ER 20
MERPS20-100105	967.879	10 - 10.5	6.6	ERC20 -10 -11	MEGA ER 20
MERPS20-105110	967.880	10.5 - 11	6.6	ERC20 -10.5 -11.5	MEGA ER 20
MERPS20-110115	967.881	11 - 11.5	6.6	ERC20 -11 -12	MEGA ER 20
MERPS20-115120	967.882	11.5 - 12	6.6	ERC20 -11.5 -12.5	MEGA ER 20
MERPS20-120125	967.883	12 - 12.5	6.6	ERC20 -12. -13	MEGA ER 20
MERPS20-125130	967.884	12.5 - 13	6.6	ERC20 -12.5 -13	MEGA ER 20

A.8

continues on the next page



Model	Order No.	Cutting shank ø	L1	Collet Model	Body
MERPS25-030035	967.885	3 - 3.5	6.3	ERC25 -3 -3.75	MEGA ER 25
MERPS25-035040	967.886	3.5 - 4	6.3	ERC25 -3.5-4.75	MEGA ER 25
MERPS25-040045	967.887	4 - 4.5	6.3	ERC25 -4.5 -5.25	MEGA ER 25
MERPS25-045050	967.888	4.5 - 5	6.3	ERC25 -5 -6	MEGA ER 25
MERPS25-050055	967.889	5 - 5.5	6.3	ERC25 -5.5-6.5	MEGA ER 25
MERPS25-055060	967.890	5.5 - 6	6.3	ERC25 -6 -7	MEGA ER 25
MERPS25-060065	967.891	6 - 6.5	6.7	ERC25 -6.5 -7.5	MEGA ER 25
MERPS25-065070	967.892	6.5 - 7	6.7	ERC25 -7 -8	MEGA ER 25
MERPS25-070075	967.893	7 - 7.5	6.7	ERC25 -7.5 -8.5	MEGA ER 25
MERPS25-075080	967.894	7.5 - 8	6.7	ERC25 -8 -9	MEGA ER 25
MERPS25-080085	967.895	8 - 8.5	6.8	ERC32 -19 -20	MEGA ER 25
MERPS25-085090	967.896	8.5 - 9	6.8	ERC25 -9 -10	MEGA ER 25
MERPS25-090095	967.897	9 - 9.5	6.8	ERC25 -9.5 -10.5	MEGA ER 25
MERPS25-095100	967.898	9.5 - 10	6.8	ERC25 -10 -11	MEGA ER 25
MERPS25-100105	967.899	10 - 10.5	7.3	ERC25 -10.5 -11.5	MEGA ER 25
MERPS25-105110	967.900	10.5 - 11	7.3	ERC25 -11 -12	MEGA ER 25
MERPS25-110115	967.901	11 - 11.5	7.3	ERC25 -11.5 -12.5	MEGA ER 25
MERPS25-115120	967.902	11.5 - 12	7.3	ERC25 -12 -13	MEGA ER 25
MERPS25-120125	967.903	12 - 12.5	7.3	ERC25 -12 -13	MEGA ER 25
MERPS25-125130	967.904	12.5 - 13	7.3	ERC25 -12.5 -13	MEGA ER 25
MERPS25-130140	967.905	13 - 14	6.6	ERC25 -13 -14.5	MEGA ER 25
MERPS25-140150	967.906	14 - 15	6.6	ERC25 -14 -15.5	MEGA ER 25
MERPS25-150160	801.318	15 - 16	6.6	ERC25 -15 -16	MEGA ER 25
MERPS32-030035	967.908	3 - 3.5	6.2	ERC32 -3 -3.75	MEGA ER 32
MERPS32-035040	967.909	3.5 - 4	6.2	ERC32 -3.5-4.25	MEGA ER 32
MERPS32-040045	967.910	4 - 4.5	6.2	ERC32 -4 -4.75	MEGA ER 32
MERPS32-045050	967.911	4.5 - 5	6.2	ERC32 -4.5 -5.25	MEGA ER 32
MERPS32-050055	967.912	5 - 5.5	6.2	ERC32 -5 -6	MEGA ER 32
MERPS32-055060	967.913	5.5 - 6	6.2	ERC32 -5.5 -6.5	MEGA ER 32
MERPS32-060065	967.914	6 - 6.5	6.6	ERC32 -6 -7	MEGA ER 32
MERPS32-065070	967.915	6.5 - 7	6.6	ERC32 -6.5 -7.5	MEGA ER 32
MERPS32-070075	967.916	7 - 7.5	6.6	ERC32 -7 -8	MEGA ER 32
MERPS32-075080	967.917	7.5 - 8	6.6	ERC32 -7.5 -8.5	MEGA ER 32
MERPS32-080085	967.918	8 - 8.5	6.7	ERC32 -8 -9	MEGA ER 32
MERPS32-085090	967.919	8.5 - 9	6.7	ERC32 -8.5 9.5	MEGA ER 32
MERPS32-090095	967.920	9 - 9.5	6.7	ERC32 -9 -10	MEGA ER 32
MERPS32-095100	967.921	9.5 - 10	6.7	ERC32 -9.5 -10.5	MEGA ER 32
MERPS32-100105	967.922	10 - 10.5	7.2	ERC32 -10 -11	MEGA ER 32
MERPS32-105110	967.923	10.5 - 11	7.2	ERC32 -10.5 -11.5	MEGA ER 32
MERPS32-110115	967.924	11 - 11.5	7.2	ERC32 -11 -12	MEGA ER 32
MERPS32-115120	967.925	11.5 - 12	7.2	ERC32 -11.5 -12.5	MEGA ER 32
MERPS32-120125	967.926	12 - 12.5	7.2	ERC32 -12 -13	MEGA ER 32
MERPS32-125130	967.927	12.5 - 13	7.2	ERC32 -12.5 -13.5	MEGA ER 32
MERPS32-130140	967.928	13 - 14	7.3	ERC32 -13 -14.5	MEGA ER 32
MERPS32-140150	967.929	14 - 15	7.3	ERC32 -14 -15.5	MEGA ER 32
MERPS32-150160	967.930	15 - 16	7.3	ERC32 -15 -16.5	MEGA ER 32
MERPS32-160170	967.931	16 - 17	7.8	ERC32 -16 -17.5	MEGA ER 32
MERPS32-170180	967.932	17 - 18	7.8	ERC32 -17 -18.5	MEGA ER 32
MERPS32-180190	967.933	18 - 19	7.8	ERC32 -18 -19.5	MEGA ER 32
MERPS32-190200	967.934	19 - 20	7.8	ERC32 -3 -3.75	MEGA ER 32

1. 1 pce. of ps ring is included.

Accessories & Spare Parts



Straight Collets

For MEGA Double Power Chuck, New Hi-Power Milling Chuck and Hydraulic Chuck

Straight Collet Selection Guide

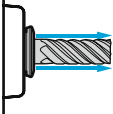
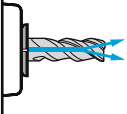
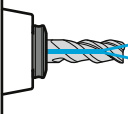
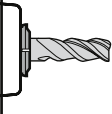
	PJC Collet	OCA Collet	PSC Collet	C Collet
				
	Periferical Coolant Supply	Through Tool Coolant Supply	Through Tool Coolant Supply	W/O Center Coolant
MEGA-D MEGA Double Power Chuck	○	○	○	○
MEGA-DS MEGA Double Power Chuck	○		○	○
HMC New Hi-Power Milling Chuck	○	○	○	○
HDC Hydraulic Chuck	○		○	

PJC Collets

For MEGA-D/DS, HMC and HDC.
For coolant to cutting tool periphery.

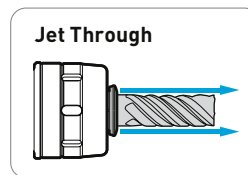
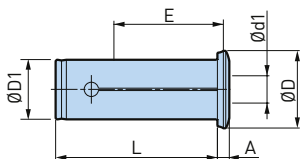

Model	Order No.	Ød1	ØD	ØD1	L	A	E
PJC12-6	805.882	6	20.4	12	40	5.4	35
PJC12-8	805.883	8	20.4	12	40	5.4	37
PJC12-10	805.884	10	20.4	12	40	5.6	39
PJC16-6	962.468	6	23	16	54	6	39
PJC16-8	962.469	8	23	16	54	6.3	40
PJC16-10	962.470	10	23	16	54	6.3	45
PJC16-12	962.471	12	23	16	54	6.3	48
PJC20-3	962.472	3	27	20	61	5.2	31
PJC20-4	962.473	4	27	20	61	5.2	31
PJC20-5	962.474	5	27	20	61	5.2	31
PJC20-6	962.475	6	27	20	61	5.2	39
PJC20-7	962.476	7	27	20	61	5.7	40
PJC20-8	962.477	8	27	20	61	5.7	40
PJC20-9	962.478	9	27	20	61	5.7	40
PJC20-10	962.479	10	27	20	61	5.7	45
PJC20-11	962.480	11	27	20	61	6.4	45
PJC20-12	962.481	12	27	20	61	6.4	50
PJC20-13	804.834	13	27	20	61	6.8	50
PJC20-14	962.488	14	27	20	61	7.3	50
PJC20-15	804.835	15	27	20	61	7.3	50
PJC20-16	962.483	16	27	20	61	7.3	50

Model	Order No.	Ød1	ØD	ØD1	L	A	E
PJC25-6	962.484	6	32.5	25	68	5	39
PJC25-8	962.485	8	32.5	25	68	5	40
PJC25-10	962.486	10	32.5	25	68	5	45
PJC25-12	962.487	12	32.5	25	68	5	50
PJC25-16	962.489	16	32.5	25	68	5.4	53
PJC25-18	801.685	18	32.5	25	68	5.8	55
PJC25-20	962.491	20	32.5	25	68	6.5	56
PJC32-6	962.492	6	39	32	74	5	39
PJC32-8	962.493	8	39	32	74	5	40
PJC32-10	962.494	10	39	32	74	5	45
PJC32-12	962.495	12	39	32	74	5	50
PJC32-14	962.496	14	39	32	74	5	50
PJC32-16	962.497	16	39	32	74	5	53
PJC32-20	962.499	20	39	32	74	5	56
PJC32-25	962.500	25	39	32	74	5.4	61
PJC42-16	801.982	16	50.5	42	83	5	53
PJC42-20	801.983	20	50.5	42	83	5	56
PJC42-25	801.984	25	50.5	42	83	5	61
PJC42-32	801.985	32	50.5	42	83	5	66

1. "E" is the min. clamping length.
2. Replacement O-ring for PJC and PSC collet are available (PJC_OR). Please contact BIG KAISER agent.
3. PJC 12 can not be used for Hydraulic Chuck (HDC12).

PSC Collets

For MEGA-D/DS, HMC and HDC.
For coolant-through tools.

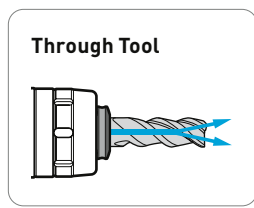
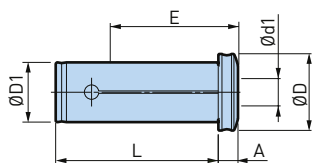

Model	Order No.	Ød1	ØD	ØD1	L	A	E
PSC20-3	962.437	3	27	20	61	7.7	31
PSC20-4	962.438	4	27	20	61	7.5	31
PSC20-5	962.439	5	27	20	61	7.5	31
PSC20-6	962.440	6	27	20	61	7.5	39
PSC20-7	962.441	7	27	20	61	8.2	40
PSC20-8	962.442	8	27	20	61	8.2	40
PSC20-9	962.443	9	27	20	61	8.2	40
PSC20-10	962.444	10	27	20	61	8.2	45
PSC20-11	962.445	11	27	20	61	8.7	45
PSC20-12	962.446	12	27	20	61	8.7	50
PSC20-13	804.827	13	27	20	61	8.7	50
PSC20-14	962.447	14	28	20	61	8.7	50
PSC20-15	804.828	15	28	20	61	8.7	50
PSC20-16	962.448	16	28	20	61	8.7	50

Model	Order No.	Ød1	ØD	ØD1	L	A	E
PSC32-6	962.457	6	38	32	74	7.5	39
PSC32-7	804.829	7	38	32	74	8.2	40
PSC32-8	962.458	8	38	32	74	8.2	40
PSC32-9	804.830	9	38	32	74	8.2	40
PSC32-10	962.459	10	38	32	74	8.2	45
PSC32-11	804.831	11	38	32	74	8.7	45
PSC32-12	962.460	12	38	32	74	8.7	50
PSC32-13	804.832	13	38	32	74	8.7	50
PSC32-14	962.461	14	38	32	74	8.7	50
PSC32-15	804.833	15	38	32	74	8.7	51
PSC32-16	962.462	16	38	32	74	8.7	53
PSC32-18	962.463	18	38	32	74	9.2	56
PSC32-19	802.063	19	38	32	74	9.2	56
PSC32-20	962.464	20	38	32	74	9.2	56
PSC32-21	802.064	21	38	32	74	9.2	56
PSC32-22	802.065	22	38	32	74	9.5	59
PSC32-23	802.066	23	38	32	74	9.5	59
PSC32-24	802.067	24	38	32	74	9.5	60
PSC32-25	962.465	25	38	32	74	9.5	61

1. "E" is the min. clamping length.
2. Replacement O-ring for PJC and PSC collet are available (PJC_OR). Please contact BIG KAISER agent.

OCA Collets

For MEGA-D and HMC

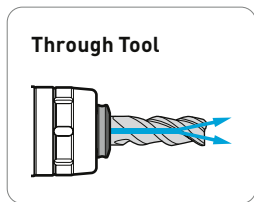
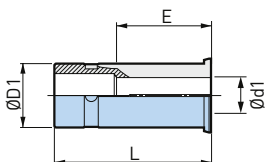

Model	Order No.	Ød1	ØD1	L	E
OCA16-6	805.156	6	16	58	36
OCA16-8	805.157	8	16	58	37
OCA16-10	805.158	10	16	58	38
OCA16-12	805.159	12	16	58	42
OCA20-6	962.401	6	20	62	36
OCA20-8	962.402	8	20	62	37
OCA20-10	962.403	10	20	62	38
OCA20-12	962.404	12	20	61	42
OCA20-14	978.501	14	20	61	42
OCA20-16	962.405	16	20	61	52
OCA25-6	801.747	6	25	72.5	36
OCA25-8	801.748	8	25	72.5	37
OCA25-10	805.413	10	25	72.5	38
OCA25-12	801.752	12	25	72.5	44
OCA25-14	805.244	14	25	71.5	44
OCA25-16	962.406	16	25	71.5	52
OCA25-18	805.245	18	25	71.5	52
OCA25-20	962.407	20	25	71.5	52

Model	Order No.	Ød1	ØD1	L	E
OCA32-6	962.408	6	32	79.5	36
OCA32-8	962.409	8	32	79.5	37
OCA32-10	962.410	10	32	79.5	38
OCA32-12	962.411	12	32	79.5	44
OCA32-13	962.412	13	32	79.5	46
OCA32-14	962.413	14	32	79.5	48
OCA32-15	962.414	15	32	79.5	50
OCA32-16	962.415	16	32	79.5	52
OCA32-17	962.416	17	32	78.5	52
OCA32-18	962.417	18	32	78.5	52
OCA32-19	962.418	19	32	78.5	52
OCA32-20	962.419	20	32	78.5	52
OCA32-21	962.420	21	32	78.5	52
OCA32-22	962.421	22	32	78.5	52
OCA32-23	962.422	23	32	78.5	52
OCA32-24	962.423	24	32	78.5	52
OCA32-25	962.424	25	32	78.5	52
OCA32-27	806.442	27	32	78.5	52
OCA32-28	805.356	28	32	78.5	52
OCA32-29	806.443	29	32	78.5	52

Model	Order No.	Ød1	ØD1	L	E
OCA42-6	801.774	6	42	79.5	36
OCA42-8	801.775	8	42	79.5	37
OCA42-10	801.764	10	42	79.5	38
OCA42-12	801.765	12	42	79.5	44
OCA42-16	801.767	16	42	79.5	52
OCA42-19	801.768	19	42	79.5	52
OCA42-20	801.769	20	42	79.5	52
OCA42-24	801.770	24	42	78.5	55
OCA42-25	801.771	25	42	78.5	55
OCA42-31	801.772	31	42	78.5	58
OCA42-32	801.773	32	42	78.5	58

1. "E" is the min. clamping length.

C Collets

For MEGA-D/DS and HMC.
Tool projection adjustable straight collet.

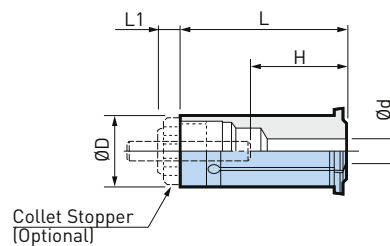

Model	Order No.	Ød	ØD	L	L1	H	E	Adjusting screw
C16-6	806.465	6	16	52	6	30 - 47	30	AC16CS
C16-8	806.466	8	16	52	6	32 - 47	32	AC16CS
C16-10	806.467	10	16	52	6	37 - 47	37	AC16CS
C16-12	806.468	12	16	52	6	37 - 47	37	AC16CS
C20-6	962.260	6	20	60	8	30 - 48	30	AC20CS
C20-8	962.262	8	20	60	8	32 - 48	32	AC20CS
C20-10	962.263	10	20	60	8	37 - 48	37	AC20CS
C20-12	962.264	12	20	60	8	37 - 48	37	AC20CS
C20-14	962.265	14	20	60	8	40 - 48	40	AC20CS
AC20-16	962.205	16	20	60	8	46 - 48	46	AC20CS
C20-16 *	962.266	16	20	60	10	46 - -	46	AC20CS
C20-18 *	800.664	18	20	60	10	50 - -	50	AC20CS
C25-6	962.271	6	25	68.5	8	30 - 58	30	AC25CS
C25-8	962.272	8	25	68.5	8	32 - 58	32	AC25CS
C25-10	962.273	10	25	68.5	8	37 - 58	37	AC25CS
C25-12	962.274	12	25	68.5	8	37 - 58	37	AC25CS
C25-14	806.478	14	25	68.5	8	45 - 58	45	AC25CS
C25-16	962.276	16	25	68.5	8	46 - 58	46	AC25CS
C25-18	806.477	18	25	68.5	8	48 - 58	48	AC25CS
C25-20	962.278	20	25	68.5	8	52 - 58	52	AC25CS

1. "E" is the min. clamping length.
2. * Collet Stopper cannot be used.
3. AC20-16 includes Collet Stopper.

Model	Order No.	Ød	ØD	L	L1	H	E	Adjusting screw
C32-6	962.281	6	32	74	10	30 - 62	30	AC32CS
C32-8	962.282	8	32	74	10	32 - 62	32	AC32CS
C32-10	962.283	10	32	74	10	37 - 62	37	AC32CS
C32-12	962.284	12	32	74	10	37 - 62	37	AC32CS
C32-14	962.285	14	32	74	10	40 - 62	40	AC32CS
C32-16	962.286	16	32	74	10	46 - 62	46	AC32CS
C32-17	807.578	17	32	74	10	50 - 62	52	AC32CS
C32-18	962.287	18	32	74	10	50 - 62	50	AC32CS
C32-19	962.248	19	32	74	10	50 - 62	50	AC32CS
C32-20	962.288	20	32	74	10	52 - 62	52	AC32CS
C32-22	962.249	22	32	74	10	52 - 62	52	AC32CS
C32-23	807.579	23	32	74	10	52 - 62	52	AC32CS
C32-24	962.250	24	32	74	10	55 - 62	55	AC32CS
C32-25	962.289	25	32	74	10	55 - 62	55	AC32CS
C32-30 *	806.476	30	32	74	10	55 - 62	65	AC32CS
C42-6	800.674	6	42	89	10	30 - 77	30	AC42CS
C42-8	800.675	8	42	89	10	34 - 77	34	AC42CS
C42-10	800.665	10	42	89	10	40 - 77	40	AC42CS
C42-12	800.666	12	42	89	10	40 - 77	40	AC42CS
C42-16	800.668	16	42	89	10	46 - 77	46	AC42CS
C42-20	800.670	20	42	89	10	52 - 77	52	AC42CS
C42-25	800.671	25	42	89	10	57 - 77	57	AC42CS
C42-31	800.672	31	42	89	10	62 - 77	62	AC42CS
C42-32	800.673	32	42	89	10	62 - 77	62	AC42CS
C42-40 *	806.198	40	42	89	10	62 - 77	79	AC42CS

A.8

Collet Stoppers for C Collet



Model	Order No.	Body	L1
AC16CS	806.197	C16	6
AC20CS	972.321	C20	8
AC25CS	804.772	C25	8
AC32CS	972.322	C32	10
AC42CS	804.773	C42	10

Adjusting Screws HMA

For MEGA Double Power Chuck and New Hi-Power Milling Chuck

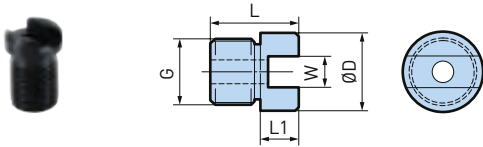

Model	Order No.	ØD	L	L1	G	W	Body	
							MEGA Double Power Chuck	New Hi-Power Milling Chuck
HMA-M16S	962.312	19	27	6	M16P1.5	10	MEGA20D/DS MEGA25D/DS MEGA32D/DS (BBT30/40, BDV40)	HMC20S/HMC20 HMC25S/HMC25 HMC32S
HMA-M24	962.313	30	36	9.5	M24P1.5	10	MEGA32D/DS (BBT50, BDV50) MEGA42D/DS (BBT50, BDV50) MEGA50D/DS (BBT50)	HMC32 HMC42S HMC42

- For MEGA16D/DS and HMC16S a commercially available hex socket head screw with M8 can be used.

A.8

Key Grip MEGA Perfect Grip

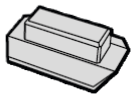

Model	Order No.	MEGA Perfect Grip
PKG16-2P	805.492	MEGA16DPG
PKG20-2P	805.493	MEGA20DPG
PKG25-2P	805.494	MEGA25DPG
PKG32-2P	805.495	MEGA32DPG

Spring MEGA Perfect Grip



Model	Order No.	MEGA Perfect Grip
PSP1519	805.496	MEGA16DPG
PSP1823	805.497	MEGA20DPG
PSP2420	805.498	MEGA25DPG
PSP3128	805.499	MEGA32DPG

- Key grip is available in a package of 2 pcs.
- It is recommended to replace the Key Grip regularly.

MEGA Wrenches

For MEGA Micro Chuck, MEGA New Baby Chuck, MEGA E Chuck, MEGA ER Grip, MEGA Double Power Chuck and MEGA Perfect Grip



Model	Order No.	Ød	MEGA Micro Chuck	MEGA New Baby Chuck	MEGA E Chuck	MEGA ER Grip	MEGA Synchro Tapping Holder
MGR10	969.449	10	MEGA3S				
MGR12	969.450	12	MEGA4S				MGT3
MGR14	969.452	14	MEGA6S				
MGR16	969.446	16					MGT6
MGR18	801.705	18	MEGA8S				
MGR20L	969.447	20					MGT12
MGR20	969.454	20		MEGA6N			
MGR25	969.456	25		MEGA8N	MEGA6E		
MGR30L	969.448	30				MEGA ER16	MGT20
MGR30	969.458	30		MEGA10N	MEGA8E		
MGR35	969.460	35		MEGA13N	MEGA10E		
MGR35L	969.460L	35				MEGA ER20	
MGR42	969.462	42		MEGA16N	MEGA13E		
MGR42L	969.462L	42				MEGA ER25	
MGR46	969.465	46		MEGA20N			
MGR50L	969.464L	50				MEGA ER32	
MGR60L	969.468L	60		MEGA25N			

A.8

Model	Order No.	Ød	MEGA Double Power Chuck	New Hi-Power Milling Chuck	MEGA Perfect Grip
MGR42L	969.462L	42	MEGA16D/DS (BBT40/BDV40, HSK-A63/F63)		
MGR43L	100237.001.0	43		HMC16S	
MGR46L	969.465L	46	MEGA16D/DS (BBT30/50/BDV50, HSK-A40/A50/A100/A125)		MEGA16DPG
MGR50L	969.464L	50	MEGA20D/DS (BBT30/40, BDV40 HSK-A50/A63/F63)	HMC20S	
MGR55L	969.467L	55		HMC25S (BBT30)	
MGR59L	807.771	59		HMC25S	
MGR60L	969.468L	60	MEGA20D/DS (BBT50, BDV50, HSK-A100/A125)	HMC20	MEGA20DPG
MGR62L	969.469L	62	MEGA25D/DS (BBT40, BDV40, HSK-A63/F63)	HMC25 HMC32S (BBT30)	
MGR68L	807.255	68		HMC32S	
MGR70L	969.470L	70	MEGA25D/DS (BBT50 / BDV50, HSK-A100/A125)		MEGA25DPG
MGR80L	969.471L	80	MEGA32D/DS (BBT50 / BDV50, HSK-A100/A125)	HMC32	MEGA32DPG
MGR85L	100237.002.0	85		HMC42S	
MGR99L	969.472L	99	MEGA42D/DS	HMC42	
MGR105L	969.473L	105	MEGA42D/DS		

1. FK wrench can also be used for New Hi-Power Milling Chuck.

MEGA Torque Wrench

For MEGA Micro Chuck, MEGA New Baby Chuck and MEGA E Chuck.
With torque limiter.



Model	Order No.	Ød	MEGA Micro Chuck	MEGA New Baby Chuck	MEGA E Chuck
MGR10TL	805.460	10	MEGA3S	-	-
MGR12TL	969.451	12	MEGA4S	-	-
MGR12TLS	804.117	12	MEGA4S	-	-
MGR14TL	969.453	14	MEGA6S	-	-
MGR14TLS	978.379	14	MEGA6S	-	-
MGR18TL	805.553	18	MEGA8S	-	-
MGR20TL	969.455	20	-	MEGA6N	-
MGR20TLS	804.119	20	-	MEGA6N	-
MGR25TL	969.457	25	-	MEGA8N	MEGA6E
MGR25TLS	804.121	25	-	MEGA8N	-
MGR30TL	969.459	30	-	MEGA10N	MEGA8E
MGR30TLS	807.585	30	-	MEGA10N	-
MGR35TL	969.461	35	-	MEGA13N	MEGA10E
MGR42TL	969.463	42	-	MEGA16N	MEGA13E
MGR46TL	969.466	46	-	MEGA20N	-

1. TLS models are recommended to tighten 3 mm or smaller inner diameter collets.

A.8

New Baby Wrenches

For New Baby Chuck and MEGA ER Grip



Model	Order No.	Nut Model
NBK6	961.525	NBN6/BPS6/ERN11
NBK6TL	979.980	NBN6/BPS6
NBK6TLS	805.970	NBN6/BPS6
NBK8	961.548	NBN8/BPS8
NBK8TL	801.758	NBN8/BPS8
NBK8TLS	805.971	NBN8/BPS8
NBK10	961.570	NBN10/BPS10/ERN16
NBK10TL	801.756	NBN10/BPS10
NBK10TLS	807.586	NBN10/BPS10
NBK13	961.596	NBN13/BPS13/ERN20
NBK13TL	801.757	NBN13/BPS13
NBK16	961.630	NBN16/BPS16/ERN25
NBK16TL	805.969	NBN16/BPS16
NBK20	961.678	NBN20/BPS20
NBK20TL	805.909	NBN20/BPS20

1. TL and TLS models are Torque Wrench.
2. TLS models are recommended to tighten 3mm or smaller inner diameter collets.

FK Wrenches

For New Hi-Power Milling Chuck and MEGA ER Grip

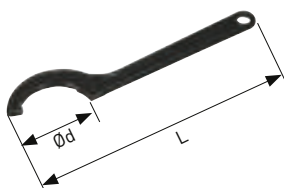

Model	Order No.	Ød	L	Body
FK31-33	806.462	31 - 33	153	HMC12J
FK45-50L	801.037	43 - 50	242	HMC16S / HMC20S / ERN32
FK52-55	962.294	52 - 55	220	HMC25S (BBT30)
FK58-62	962.291	58 - 62	240	HMC20 / HMC25 (BBT50 / BDV50)
FK58-62L	801.038	58 - 62	293	HMC25S (BBT40/50 / BDV40/50) / HMC32S (BBT30)
FK68-75L	801.039	68 - 75	319	HMC32S (BBT40/50 / BDV40/50)
FK80-90	962.292	80 - 90	280	HMC32 (BBT50 / BDV50)
FK80-90L	804.771	80 - 90	390	HMC42S
FK92-100	962.293	92 - 100	280	HMC42

Digital MEGA Torque Wrench

Digital torque wrench with interchangeable head specialized for MEGA chuck to manage the tightening torque of collet chucks.

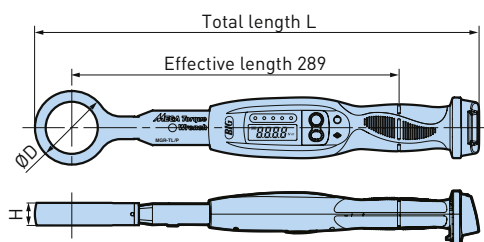

Body

Model	Order No.
MGR-TL/P.	807.594

1. Weight does not include adapter and battery.

Adapter

Model	Order No.	Applicable Collet Chuck	L	ØD	H
MGR20A-N	804.118	MEGA6N	-	377	36
MGR25A-N	804.120	MEGA8N	MEGA6E	381	44
MGR30A-N	804.122	MEGA10N	MEGA8E	384	50
MGR35A-N	804.123	MEGA13N	MEGA10E	386.5	55
MGR42A-N	804.124	MEGA16N	MEGA13E	390	62
MGR46A-N	804.125	MEGA20N	-	392	66

1. Can only be used for above applicable models (e.g. MEGAER Chuck).

Set

Model	Order No.	Content
SMGR-TL/P.	807.595	1 Body 6 Adapters (each 1 of MGR20-46A-N)

Dedicated storage case

The body (MGR-TL/P.) and the set (SMGR-TL/P.) are delivered in an exclusive case for convenient carrying. Body and 6 adapters can be stored.



Recommended torque

The recommended torque for each collet chuck is set on the main unit for easy operation.



Select the tool name before clamping. (e.g. MEGA6N)

LED torque indicator

When tightening torque is applied, the torque value is displayed on the display panel and the LED indicators light up in real time.



The indicator informs every 20% of the target torque. (e.g. 60% of target torque)

Vibrations and buzzers

Vibration of the handle and buzzer will notify when tightened to the target torque.

Model	MGR-TL/P
Torque setting range	5-50Nm
Minimum read	0.01Nm
Display	7 LCD segments -> 4 digits, numerical display High precision LED indicator five-level display
Basic functions	Battery level display (three levels) Peak hold function Auto Power OFF (1 hour) Tightening completion alarm -> sound emission and vibrations
Power supply *	2 x LR6 batteries [recommended alkaline batteries/NiMH rechargeable batteries]
Continuous use time	Approx. 70 hours (NiMH rechargeable batteries/tightening condition: 100 times/h)
Operating temperature (recommended range)	0°C - 40°C (15°C - 30°C) Condensation has to be avoided

1. * Batteries are not included.

Adjusting Screws HDA

For Hydraulic Chuck

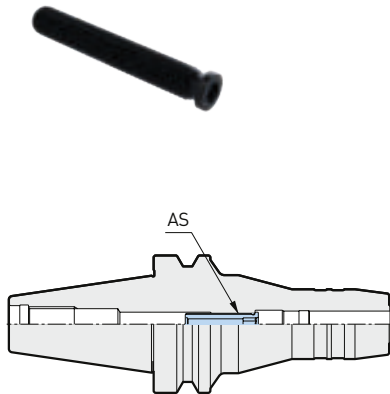

One side socket type

Model	Order No.
HDA6-05013	803.741
HDA6-05020	803.742
HDA6-05032	803.743
HDA8-06013	803.744
HDA8-06020	803.745
HDA8-06032	803.746
HDA10-08015	803.747
HDA10-08032	803.748
HDA12-10010	803.749
HDA12-10025	803.750
HDA12-10032	803.751
HDA16-12015	803.752
HDA16-12030	802.337
HDA16-12037	803.754
HDA20-16015	803.755
HDA25-16033	803.756
HDA25-16039	803.757

Both side socket type

Model	Order No.
HDA6-05013W	802.392
HDA6-05020W	802.393
HDA6-05032W	802.394
HDA8-06013W	803.758
HDA8-06020W	803.759
HDA8-06032W	803.760
HDA10-08015W	803.761
HDA10-08032W	803.762
HDA12-10025W	803.763
HDA12-10032W	802.383
HDA16-12015W	802.384
HDA16-12030W	802.385
HDA16-12037W	802.386
HDA20-16015W	802.387
HDA25-16033W	802.388
HDA25-16039W	802.389
HDA6-20010 *	802.390
HDA20-12047 *	802.391

A.8

1. Both side hexagon socket type can be adjusted from interface and tool clamping side.
2. * Adjusting Screw and Guide Screw are contained as a set
3. Adjusting screw HDA4-05015W is available with 807.254.

Grip Bars Type TSB

For confirming the gripping force for Hydraulic Chuck.



Model	Order No.	ØD
TSB3	807.102	3
TSB4	807.103	4
TSB5	807.104	5
TSB6	804.873	6
TSB7	804.874	7
TSB8	804.875	8
TSB9	804.876	9
TSB10	804.861	10
TSB11	804.862	11
TSB12	804.863	12
TSB13	804.864	13
TSB14	804.865	14
TSB15	804.866	15
TSB16	804.867	16
TSB18	804.868	18
TSB19	807.105	19
TSB20	804.869	20
TSB22	807.106	22
TSB24	807.107	24
TSB25	804.870	25
TSB28	807.108	28
TSB31	807.109	31
TSB32	804.871	32
TSB42	804.872	42

Clamp Bolts

For Face Mill Arbor FMH and Smart Damper FMH type

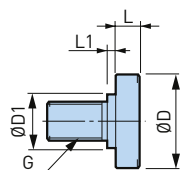

Fig. 1

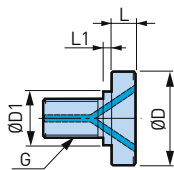
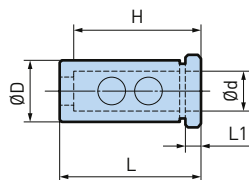

Fig. 2

Model	Order No.	Fig.	ØD	ØD1	L	L1	G
MBA-M12	802.757	1	33	23	10	2	M12
MBA-M12H	802.758	1	33		10	-	M12
TMBA-M12 *	802.767	2	33	23	10	2	M12
MBA-M16	802.759	1	40	23	10	6	M16
MBA-M16H	802.760	1	40		10	-	M16
TMBA-M16 *	802.768	2	40	23	10	6	M16
MBA-M20	802.761	1	50	27	14	6	M20
MBA-M20H	802.762	1	50		14	-	M20
TMBA-M20 *	802.769	2	50	27	14	6	M20

Sleeves for Side Lock Holder

For TSL & OSL



Model	Order No.	Ød	ØD	L	L1	H
OSL25-16	962.596	16	25	62	5.5	48
OSL25-20	962.597	20	25	62	5.5	50
OSL32-16	962.586	16	32	66	5.5	48
OSL32-20	962.598	20	32	66	5.5	50
OSL32-25	962.599	25	32	66	5.5	56
OSL40-16	804.678	16	40	76	5.5	48
OSL40-20	804.679	20	40	76	5.5	50
OSL40-25	962.581	25	40	76	5.5	56
OSL40-32	962.582	32	40	76	5.5	60

A.8

Sleeve for BSL Boring Bar Holders

For BSL

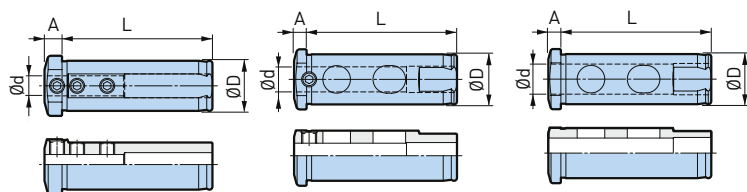

Fig. 1

Fig. 2

Fig. 3

Model	Order No.	Fig.	Ød	ØD	L	A
BSLA20-6	805.728	1	6	20	60	5
BSLA20-8	805.733	1	8	20	60	7
BSLA20-10	805.734	2	10	20	60	5
BSLA20-12	805.735	3	12	20	60	5
BSLA20-16	805.736	3	16	20	60	5
BSLA32-10	805.737	1	10	32	75	9
BSLA32-12	805.738	1	12	32	75	9
BSLA32-16	805.739	2	16	32	75	6
BSLA32-20	805.740	3	20	32	75	6

Hook wrench for Super Keyless Chuck (FS)



Model	Order No.
FS6.5LC	805.532
FS13LC	805.446

Tap Holders for MEGA Synchro Tapping Holder DIN

Tap Holders MGT6

Available in short, long and extra long length (150 mm, 200 mm) to meet all production requirements.

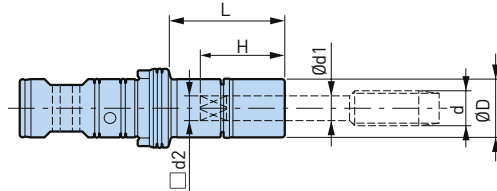

MGT6 (Tap size DIN: M3 - M8; ISO: M3 - M5)

Model	Order No.	Tap Size d DIN 371	Tap Size d DIN 376	Tap Size d ISO 529	Ød1	d2	ØD	L	H
MGT6-031025-30	963.611	-	-	M3	3.15	2.5	16	30	20
MGT6-031025-70	963.612	-	-	M3	3.15	2.5	16	70	20
MGT6-031025-100	963.613	-	-	M3	3.15	2.5	16	100	20
MGT6-031025-150	963.614	-	-	M3	3.15	2.5	16	150	20
MGT6-035027-30	963.615	M3	M5	-	3.5	2.7	16	30	21
MGT6-035027-70	963.616	M3	M5	-	3.5	2.7	16	70	21
MGT6-035027-100	963.617	M3	M5	-	3.5	2.7	16	100	21
MGT6-035027-150	963.618	M3	M5	-	3.5	2.7	16	150	21
MGT6-040032-30	963.619	-	-	M4	4	3.15	16	30	21
MGT6-040032-70	963.620	-	-	M4	4	3.15	16	70	21
MGT6-040032-100	963.621	-	-	M4	4	3.15	16	100	21
MGT6-040032-150	963.622	-	-	M4	4	3.15	16	150	21
MGT6-045034-30	963.623	M4	M6	-	4.5	3.4	16	30	21
MGT6-045034-70	963.624	M4	M6	-	4.5	3.4	16	70	21
MGT6-045034-100	963.625	M4	M6	-	4.5	3.4	16	100	21
MGT6-045034-150	963.626	M4	M6	-	4.5	3.4	16	150	21
MGT6-050040-30	963.627	-	-	M5	5	4.0	16	30	25
MGT6-050040-70	963.628	-	-	M5	5	4.0	16	70	25
MGT6-050040-100	963.629	-	-	M5	5	4.0	16	100	25
MGT6-050040-150	963.630	-	-	M5	5	4.0	16	150	25
MGT6-050040-200	963.631	-	-	M5	5	4.0	16	200	25
MGT6-060049-30	963.632	M5, M6	M8	-	6	4.9	16	30	26
MGT6-060049-70	963.633	M5, M6	M8	-	6	4.9	16	70	26
MGT6-060049-100	963.634	M5, M6	M8	-	6	4.9	16	100	26
MGT6-060049-150	963.635	M5, M6	M8	-	6	4.9	16	150	26
MGT6-060049-200	963.636	M5, M6	M8	-	6	4.9	16	200	26

1. Nut is included.
2. MEGA wrench is to be ordered separately.

Accessories & Spare Parts

<p>MGT Nuts</p>  <p>► 364</p>	<p>MEGA Wrenches</p>  <p>► 351</p>
--	---

Tap Holders for MEGA Synchro Tapping Holder JIS

Tap Holders MGT6

Available in short, long and extra long length (150 mm, 200 mm) to meet all production requirements.

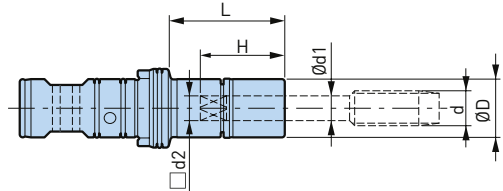

MGT6 (Tap size JIS: M2 - M6)

Model	Order No.	Tap Size d Metric	Tap Size d Unify	Ød1	d2	ØD	L	H	H
MGT6-M2-30	963.400	M2	Nr. 3;Nr. 4	3	2.5	16	30	19	19
MGT6-M2-70	801.481	M2	Nr. 3;Nr. 4	3	2.5	16	70	19	19
MGT6-M2-100	801.479	M2	Nr. 3;Nr. 4	3	2.5	16	100	19	19
MGT6-M2-150	801.480	M2	Nr. 3;Nr. 4	3	2.5	16	150	19	19
MGT6-M3-30	801.484	M3	Nr. 5;Nr. 6	4	3.2	16	30	21	21
MGT6-M3-70	801.485	M3	Nr. 5;Nr. 6	4	3.2	16	70	21	21
MGT6-M3-100	801.482	M3	Nr. 5;Nr. 6	4	3.2	16	100	21	21
MGT6-M3-150	801.483	M3	Nr. 5;Nr. 6	4	3.2	16	150	21	21
MGT6-M4-30	801.489	M4	Nr. 8	5	4.0	16	30	25	25
MGT6-M4-70	801.490	M4	Nr. 8	5	4.0	16	70	25	25
MGT6-M4-100	801.486	M4	Nr. 8	5	4.0	16	100	25	25
MGT6-M4-150	801.487	M4	Nr. 8	5	4.0	16	150	25	25
MGT6-M4-200	801.488	M4	Nr. 8	5	4.0	16	200	25	25
MGT6-M5-30	801.494	M5	Nr. 10;Nr. 12	5.5	4.5	16	30	25	25
MGT6-M5-70	801.495	M5	Nr. 10;Nr. 12	5.5	4.5	16	70	25	25
MGT6-M5-100	801.491	M5	Nr. 10;Nr. 12	5.5	4.5	16	100	25	25
MGT6-M5-150	801.492	M5	Nr. 10;Nr. 12	5.5	4.5	16	150	25	25
MGT6-M5-200	801.493	M5	Nr. 10;Nr. 12	5.5	4.5	16	200	25	25
MGT6-M6U1/4-30	801.499	M6	U1/4	6	4.5	16	30	25	25
MGT6-M6U1/4-70	801.500	M6	U1/4	6	4.5	16	70	25	25
MGT6-M6U1/4-100	801.496	M6	U1/4	6	4.5	16	100	25	25
MGT6-M6U1/4-150	801.497	M6	U1/4	6	4.5	16	150	25	25
MGT6-M6U1/4-200	801.498	M6	U1/4	6	4.5	16	200	25	25

A.8

1. Nut is included.
2. MEGA wrench is to be ordered separately.

Accessories & Spare Parts

<p>MGT Nuts</p> <p>▶ 364</p>	<p>MEGA Wrenches</p> <p>▶ 351</p>
-------------------------------------	--

Tap Holders for MEGA Synchro Tapping Holder DIN

Tap Holders MGT12

Available in short, long and extra long length (150 mm, 200 mm) to meet all production requirements.

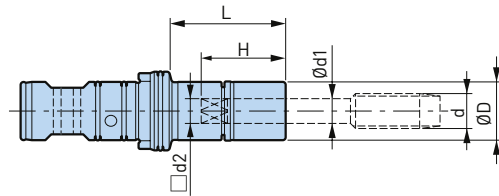

MGT12 (Tap size DIN: M5 - M12; ISO: M6 - M12)

Model	Order No.	Tap Size d DIN 371	Tap Size d DIN 376	Tap Size d ISO 529	Ød1	d2	ØD	L	H
MGT12-060049-30	963.637	M5, M6	M8	-	6	4.9	20	30	28
MGT12-060049-70	963.638	M5, M6	M8	-	6	4.9	20	70	28
MGT12-060049-100	963.639	M5, M6	M8	-	6	4.9	20	100	28
MGT12-060049-150	963.640	M5, M6	M8	-	6	4.9	20	150	28
MGT12-060049-200	963.641	M5, M6	M8	-	6	4.9	20	200	28
MGT12-063050-30	963.642	-	-	M6	6.3	5.0	20	30	28
MGT12-063050-70	963.643	-	-	M6	6.3	5.0	20	70	28
MGT12-063050-100	963.644	-	-	M6	6.3	5.0	20	100	28
MGT12-063050-150	963.645	-	-	M6	6.3	5.0	20	150	28
MGT12-063050-200	963.646	-	-	M6	6.3	5.0	20	200	28
MGT12-070055-30	963.647	-	M10	-	7	5.5	20	30	28
MGT12-070055-70	963.648	-	M10	-	7	5.5	20	70	28
MGT12-070055-100	963.649	-	M10	-	7	5.5	20	100	28
MGT12-070055-150	963.650	-	M10	-	7	5.5	20	150	28
MGT12-070055-200	963.651	-	M10	-	7	5.5	20	200	28
MGT12-080063-30	963.652	M8	-	M8	8	6.3	20	30	29
MGT12-080063-70	963.653	M8	-	M8	8	6.3	20	70	29
MGT12-080063-100	963.654	M8	-	M8	8	6.3	20	100	29
MGT12-080063-150	963.655	M8	-	M8	8	6.3	20	150	29
MGT12-080063-200	963.656	M8	-	M8	8	6.3	20	200	29
MGT12-090071-30	963.657	-	M12	M12	9	7.1	20	30	30
MGT12-090071-70	963.658	-	M12	M12	9	7.1	20	70	30
MGT12-090071-100	963.659	-	M12	M12	9	7.1	20	100	30
MGT12-090071-150	963.660	-	M12	M12	9	7.1	20	150	30
MGT12-090071-200	963.661	-	M12	M12	9	7.1	20	200	30
MGT12-100080-35	807.211	M10	-	M10	10	8.0	30	35	33
MGT12-100080-85	807.212	M10	-	M10	10	8.0	30	85	33
MGT12-100080-115	807.213	M10	-	M10	10	8.0	30	115	33
MGT12-100080-150	807.214	M10	-	M10	10	8.0	30	150	33

1. Nut is included.
2. MEGA wrench is to be ordered separately.

Accessories & Spare Parts

<p>MGT Nuts</p> <p>► 364</p>	<p>MEGA Wrenches</p> <p>► 351</p>
------------------------------	-----------------------------------

Tap Holders for MEGA Synchro Tapping Holder JIS

Tap Holders MGT12

Available in short, long and extra long length (150 mm, 200 mm) to meet all production requirements.

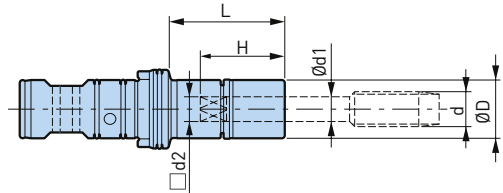



MGT12 (Tap size JIS: M6 - M12)

Model	Order No.	Tap Size d Metric	Tap Size d Pipe	Tap Size d Unify	Ød1	d2	ØD	L	H
MGT12-M6U1/4-30	978.286	M6	-	U1/4	6	4.5	20	30	27
MGT12-M6U1/4-70	801.415	M6	-	U1/4	6	4.5	20	70	27
MGT12-M6U1/4-100	801.412	M6	-	U1/4	6	4.5	20	100	27
MGT12-M6U1/4-150	801.413	M6	-	U1/4	6	4.5	20	150	27
MGT12-M6U1/4-200	801.414	M6	-	U1/4	6	4.5	20	200	27
MGT12-U5/16-30	801.424	-	-	U5/16	6.1	5.0	20	30	28
MGT12-U5/16-70	801.425	-	-	U5/16	6.1	5.0	20	70	28
MGT12-U5/16-100	801.421	-	-	U5/16	6.1	5.0	20	100	28
MGT12-U5/16-150	801.422	-	-	U5/16	6.1	5.0	20	150	28
MGT12-U5/16-200	801.423	-	-	U5/16	6.1	5.0	20	200	28
MGT12-M8-30	978.287	M8	-	-	6.2	5.0	20	30	28
MGT12-M8-70	801.419	M8	-	-	6.2	5.0	20	70	28
MGT12-M8-100	801.416	M8	-	-	6.2	5.0	20	100	28
MGT12-M8-150	801.417	M8	-	-	6.2	5.0	20	150	28
MGT12-M8-200	801.418	M8	-	-	6.2	5.0	20	200	28
MGT12-M10U3/8-30	978.288	M10	-	U3/8	7	5.5	20	30	28
MGT12-M10U3/8-70	801.408	M10	-	U3/8	7	5.5	20	70	28
MGT12-M10U3/8-100	801.405	M10	-	U3/8	7	5.5	20	100	28
MGT12-M10U3/8-150	801.406	M10	-	U3/8	7	5.5	20	150	28
MGT12-M10U3/8-200	801.407	M10	-	U3/8	7	5.5	20	200	28
MGT12-U7/16P1/8-30	801.429	-	P1/8	U7/16	8	6.0	20	30	29
MGT12-U7/16P1/8-70	801.430	-	P1/8	U7/16	8	6.0	20	70	29
MGT12-U7/16P1/8-100	801.426	-	P1/8	U7/16	8	6.0	20	100	29
MGT12-U7/16P1/8-150	801.427	-	P1/8	U7/16	8	6.0	20	150	29
MGT12-U7/16P1/8-200	801.428	-	P1/8	U7/16	8	6.0	20	200	29
MGT12-M12-30	978.289	M12	-	-	8.5	6.5	20	30	29
MGT12-M12-70	801.411	M12	-	-	8.5	6.5	20	70	29
MGT12-M12-100	801.409	M12	-	-	8.5	6.5	20	100	29
MGT12-M12-150	963.399	M12	-	-	8.5	6.5	20	150	29
MGT12-M12-200	801.410	M12	-	-	8.5	6.5	20	200	29

1. Nut is included.
2. MEGA wrench is to be ordered separately.

Accessories & Spare Parts

<p>MGT Nuts</p>  <p>▶ 364</p>	<p>MEGA Wrenches</p>  <p>▶ 351</p>
---	--

A.8

Tap Holders for MEGA Synchro Tapping Holder DIN

Tap Holders MGT20

Available in short, long and extra long length (150 mm, 200 mm) to meet all production requirements.

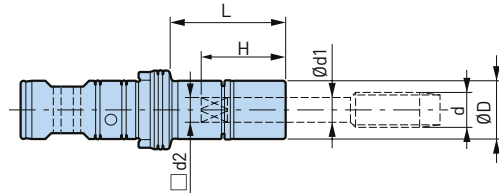

MGT20 (Tap size DIN: M10 - M20; ISO: M10 - M20)

Model	Order No.	Tap Size d DIN 371	Tap Size d DIN 376	Tap Size d ISO 529	Ød1	d2	ØD	L	H
MGT20-090071-35	963.662	-	M12	M12	9	7.1	30	35	30
MGT20-090071-85	963.663	-	M12	M12	9	7.1	30	85	30
MGT20-090071-115	963.664	-	M12	M12	9	7.1	30	115	30
MGT20-090071-150	963.665	-	M12	M12	9	7.1	30	150	30
MGT20-100080-35	963.666	M10	-	M10	10	8.0	30	35	33
MGT20-100080-85	963.667	M10	-	M10	10	8.0	30	85	33
MGT20-100080-115	963.668	M10	-	M10	10	8.0	30	115	33
MGT20-100080-150	963.669	M10	-	M10	10	8.0	30	150	33
MGT20-110090-35	963.670	-	M14	-	11	9.0	30	35	34
MGT20-110090-85	963.671	-	M14	-	11	9.0	30	85	34
MGT20-110090-115	963.672	-	M14	-	11	9.0	30	115	34
MGT20-110090-150	963.673	-	M14	-	11	9.0	30	150	34
MGT20-112090-35	963.674	-	-	M14	11.2	9.0	30	35	34
MGT20-112090-85	963.675	-	-	M14	11.2	9.0	30	85	34
MGT20-112090-115	963.676	-	-	M14	11.2	9.0	30	115	34
MGT20-112090-150	963.677	-	-	M14	11.2	9.0	30	150	34
MGT20-120090-35	963.678	-	M16	-	12	9.0	30	35	34
MGT20-120090-85	963.679	-	M16	-	12	9.0	30	85	34
MGT20-120090-115	963.680	-	M16	-	12	9.0	30	115	34
MGT20-120090-150	963.681	-	M16	-	12	9.0	30	150	34
MGT20-125100-35	963.682	-	-	M16	12.5	10.0	30	35	35
MGT20-125100-85	963.683	-	-	M16	12.5	10.0	30	85	35
MGT20-125100-115	963.684	-	-	M16	12.5	10.0	30	115	35
MGT20-125100-150	963.685	-	-	M16	12.5	10.0	30	150	35
MGT20-140110-35	963.686	-	M18	-	14	11.0	30	35	36
MGT20-140110-85	963.687	-	M18	-	14	11.0	30	85	36
MGT20-140110-115	963.688	-	M18	-	14	11.0	30	115	36
MGT20-140110-150	963.689	-	M18	-	14	11.0	30	150	36
MGT20-140112-35	963.690	-	-	M18, M20	14	11.2	30	35	36
MGT20-140112-85	963.691	-	-	M18, M20	14	11.2	30	85	36
MGT20-140112-115	963.692	-	-	M18, M20	14	11.2	30	115	36
MGT20-140112-150	963.693	-	-	M18, M20	14	11.2	30	150	36
MGT20-160120-35	805.173	-	M20	-	16	12.0	30	35	37
MGT20-160120-150	805.172	-	M20	-	16	12.0	30	150	37

1. Nut is included.
2. MEGA wrench is to be ordered separately.

Tap Holders for MEGA Synchro Tapping Holder JIS

Tap Holders MGT20

Available in short, long and extra long length (150 mm, 200 mm) to meet all production requirements.

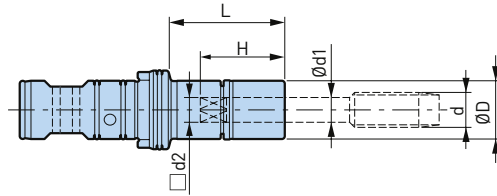

MGT20 (Tap size JIS: M12 - M20)

Model	Order No.	Tap Size d Metric	Tap Size d Pipe	Tap Size d Unify	Ød1	d2	ØD	L	H
MGT20-M12-35	801.433	M12	-	-	8.5	6.5	30	35	29
MGT20-M12-85	801.434	M12	-	-	8.5	6.5	30	85	29
MGT20-M12-115	801.431	M12	-	-	8.5	6.5	30	115	29
MGT20-M12-150	801.432	M12	-	-	8.5	6.5	30	150	29
MGT20-U1/2-35	801.460	-	-	U1/2	9	7.0	30	35	30
MGT20-U1/2-85	801.461	-	-	U1/2	9	7.0	30	85	30
MGT20-U1/2-115	804.130	-	-	U1/2	9	7.0	30	115	30
MGT20-U1/2-150	804.128	-	-	U1/2	9	7.0	30	150	30
MGT20-M14U9/16-35	801.437	M14	-	U9/16	10.5	8.0	30	35	33
MGT20-M14U9/16-85	801.438	M14	-	U9/16	10.5	8.0	30	85	33
MGT20-M14U9/16-115	801.435	M14	-	U9/16	10.5	8.0	30	115	33
MGT20-M14U9/16-150	801.436	M14	-	U9/16	10.5	8.0	30	150	33
MGT20-P1/4-35	801.454	-	P1/4	-	11	9.0	30	35	31
MGT20-P1/4-85	801.455	-	P1/4	-	11	9.0	30	85	31
MGT20-P1/4-115	801.452	-	P1/4	-	11	9.0	30	115	31
MGT20-P1/4-150	801.453	-	P1/4	-	11	9.0	30	150	31
MGT20-U5/8-35	801.462	-	-	U5/8	12	9.0	30	35	34
MGT20-U5/8-85	801.463	-	-	U5/8	12	9.0	30	85	34
MGT20-U5/8-115	804.131	-	-	U5/8	12	9.0	30	115	34
MGT20-U5/8-150	804.129	-	-	U5/8	12	9.0	30	150	34
MGT20-M16-35	801.441	M16	-	-	12.5	10.0	30	35	35
MGT20-M16-85	801.442	M16	-	-	12.5	10.0	30	85	35
MGT20-M16-115	801.439	M16	-	-	12.5	10.0	30	115	35
MGT20-M16-150	801.440	M16	-	-	12.5	10.0	30	150	35
MGT20-M18U3/4-35	801.445	M18	-	U3/4	14	11.0	30	35	36
MGT20-M18U3/4-85	801.446	M18	-	U3/4	14	11.0	30	85	36
MGT20-M18U3/4-115	801.443	M18	-	U3/4	14	11.0	30	115	36
MGT20-M18U3/4-150	801.444	M18	-	U3/4	14	11.0	30	150	36
MGT20-P3/8-35	801.458	-	P3/8	-	14	11.0	30	35	33
MGT20-P3/8-85	801.459	-	P3/8	-	14	11.0	30	85	33
MGT20-P3/8-115	801.456	-	P3/8	-	14	11.0	30	115	33
MGT20-P3/8-150	801.457	-	P3/8	-	14	11.0	30	150	33
MGT20-M20-35	801.449	M20	-	-	15	12.0	30	35	37
MGT20-M20-85	801.450	M20	-	-	15	12.0	30	85	37
MGT20-M20-115	801.447	M20	-	-	15	12.0	30	115	37
MGT20-M20-150	801.448	M20	-	-	15	12.0	30	150	37

1. Nut is included.
2. MEGA wrench is to be ordered separately.

Tap Holders for MEGA Synchro Tapping Holder DIN

Tap Holders MGT36

A specially developed system to compensate for synchronisation errors and greatly reduce load during tapping.

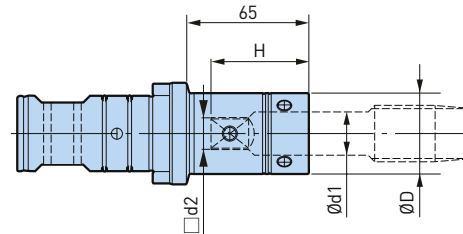

MGT36 (Tap size DIN: M22 - M36)

Model	Order No.	Tap Size d DIN 376	Tap Size d DIN 353	Ød1	d2	ØD	H
MGT36-180145-65	805.240	M22, 24	P5/8	18	14.5	38	45
MGT36-200160-65	805.241	M27	P3/4	20	16.0	40	51
MGT36-220180-65	805.238	M30	P7/8	22	18.0	42	53
MGT36-250200-65	805.242	M33	P1	25	20.0	49	58
MGT36-280220-65	805.239	M36	-	28	22.0	52	62

A.8

1. Wrench is not required.

Accessories & Spare Parts

<p>Adjusting Screw for MGT36</p> <p>▶ 365</p>	<p>Side Lock Bolt Set for MGT36</p> <p>▶ 365</p>	<p>MGT Set Screw</p> <p>▶ 364</p>	<p>Synchro Adjuster</p> <p>▶ 364</p>	<p>O-Ring Set</p> <p>▶ 364</p>
---	--	-----------------------------------	--------------------------------------	--------------------------------

Tap Holders for MEGA Synchro Tapping Holder JIS

Tap Holders MGT36

A specially developed system to compensate for synchronisation errors and greatly reduce load during tapping.

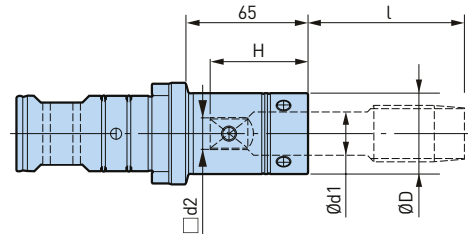

MGT36 (Tap size JIS: M20 - M36; P1/4, P3/4, P1)

Model	Order No.	Tap Size	Tap Length l	Ød1	d2	ØD	H
MGT36-M20-65	801.465	M20	65 - 68	15	12.0	32	40
MGT36-M22-65	801.466	M22	65 - 68	17	13.0	34	44
MGT36-P1/2-65	801.471	P1/2	38 - 41	18	14.0	35	42
MGT36-M24-65	978.330	M24	65 - 68	19	15.0	39	46
MGT36-M27-65	801.467	M27	80 - 83	20	15.0	40	50
MGT36-M30-65	801.468	M30	83 - 86	23	17.0	43	52
MGT36-P3/4-65	801.473	P3/4	38 - 41	23	17.0	43	47
MGT36-M33-65	801.469	M33	88 - 91	25	19.0	49	57
MGT36-P1-65	801.472	P1	49 - 52	26	21.0	50	46
MGT36-M36-65	978.331	M36	94 - 97	28	21.0	52	61

1. Wrench is not required.

A.8

Accessories & Spare Parts

<p>Adjusting Screw for MGT36</p> <p>▶ 365</p>	<p>Side Lock Bolt Set for MGT36</p> <p>▶ 365</p>	<p>MGT Set Screw</p> <p>▶ 364</p>	<p>Synchro Adjuster</p> <p>▶ 364</p>	<p>O-Ring Set</p> <p>▶ 364</p>
---	--	-----------------------------------	--------------------------------------	--------------------------------

Accessories for MEGA Synchro Tapping Holder

MGT Set Screw

For MGT6, MGT12, MGT20, MGT36

Hi- tensile material. Secures the tap holder into body.

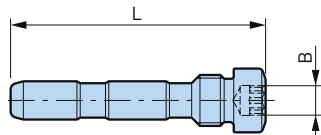

Model	Order No.	B	L	Body
MGT6SS	963.711	4	35	MGT6
MGT12SS	963.432	4	40	MGT12
MGT20SS	963.713	5	53	MGT20
MGT36SS	801.478	8	92	MGT36

Synchro Adjuster

For MGT6, MGT12, MGT20, MGT36

Replaceable bushing in tap holder.

A.8

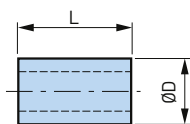

Fig. 1

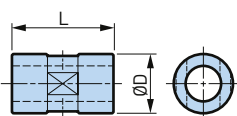

Fig. 2

Model	Order No.	Fig.	ØD	L	Tap Holder
MGT6SA-5P	963.721	1	9	11	MGT 6-d-
MGT12SA-5P	963.722	1	10	15	MGT 12-d-
MGT20SA-5P	963.723	1	14	24	MGT 20-d-
MGT36SA-5P	801.474	1	20	32	MGT 36-d-
MGT6SAH *	807.197	2	9	11	MGT 6-d-
MGT12SAH *	807.198	2	10	15	MGT 12-d-
MGT20SAH *	807.199	2	14	24	MGT 20-d-

1. Set content 5 pieces.
2. Soft type is included in our standard MEGA Synchro tapping holders.
3. * Hard Type, single piece
4. Hard Type is recommendet for eccentric thread relief tap.

O-Ring Set

For MGT6, MGT12, MGT20

Set includes 1 small, 2 large size.

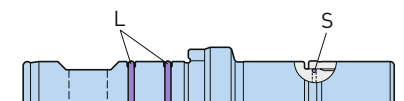

Model	Order No.	Nut. Dia	Tap Holder
MGT6OR	801.501	Ø 16	MGT 6-d-
MGT12OR	801.420	Ø 20	MGT 12-d-
MGT20OR	801.451	Ø 30	MGT 20-d-
MGT36OR	801.470	-	MGT 36-d-

MGT Nuts

For MGT6, MGT12, MGT20

Exclusive nut for MEGA synchro tapping holder.

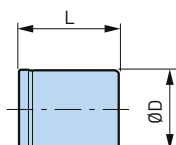

Model	Order No.	ØD	L	Tap Holder
MGN6T	963.700	16	19	MGT 6-d-
MGN12T	963.702	20	21	MGT 12-d-
MGN20T	963.703	30	24	MGT 20-d-

MEGA Wrench

For MGT3, MGT6, MGT12, MGT20

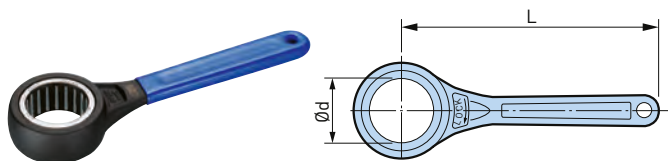

Model	Order No.	Ød	L	Tap Holder
MGR12	969.450	12	90	MGT 3
MGR16	969.446	16	90	MGT 6-d-
MGR20L	969.447	20	160	MGT12-06,-07,-08,-09
MGR30L	969.448	30	220	MGT12-10 / MGT20-d

Micro Collet

For MGT3

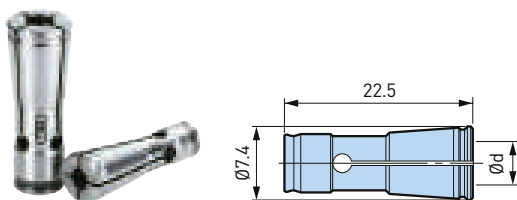

Model	Order No.	Tapping Range			Tap Shank
		DIN 371	ISO 529	JIS	Ød
NBC4S-2.5AA	961.468	M1 - M1.8	M2	-	2.5
-2.8AA	968.353	M2 - M2.6	M2.2, M2.5	-	2.8
-3.0AA	961.470	-	-	M1 - M2.6	3.0
-3.1AA	968.355	-	M3	-	3.15
-3.5AA	961.472	M3	-	-	3.5
-4.0AA	961.474	-	-	M3	4.0

1. Other sizes available. Please refer to micro collet.

A.8

Adjusting Screw for MGT36

Adjustment of tap projection length (Adjustable amount: 3 mm). Coolant supply can be switched by reversing the adjust screw.

Tap without hole

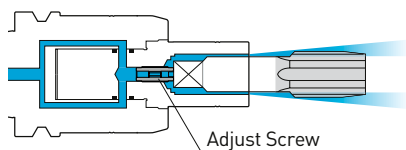

Tap with hole

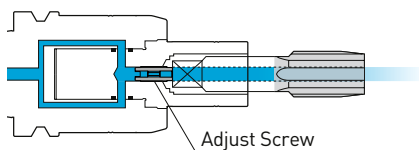

Model	Order No.	Body
MGT36AJ	801.464	MGT36

Side Lock Bolt Set for MGT36

Spare locking screw to clamp a tap.



Set Model	Order No.	Tap Holder Model		Bolt size
		DIN	JIS	
MGT36SL6	801.476	-	MGT36 -M20 -65	M6 x 8L (x4)
		-	-M22 -65	+
		-	-P1/2 -65	M6 x 10L (x2)
MGT36SL8	801.477	MGT36 -180145-65	-M24 -65	M8 x 10L (x4)
		-200160-65	-M27 -65	+
		-220180-65	-M30 -65	M8 x 12L (x2)
		-	-P3/4 -65	
MGT36SL10	801.475	MGT36 -250200-65	MGT36 -M33 -65	M10 x 12L (x4)
		-280220-65	-M36 -65	+
		-	-P1 -65	M10 x 14L (x2)

Air Filter Regulator for RBX

Model XF1

1. Mist separator (filtration: 0,3 µm).
2. Micro mist separator (filtration: 0,01 µm).
3. Precision regulator.
4. Three ports valves for extracting pressurization (non-grease type).

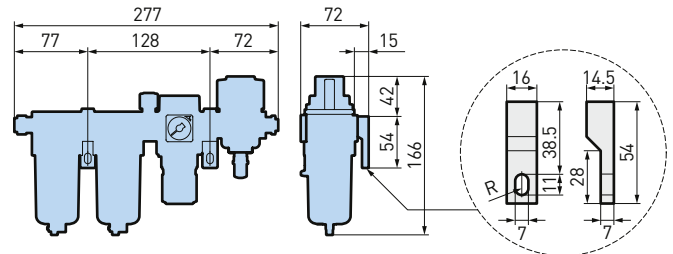
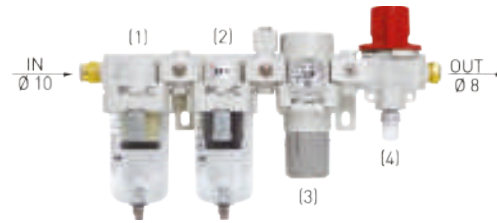

Model	Order No.
XF1	962.661

A.8 Collet for Angle Head Small Bore Type

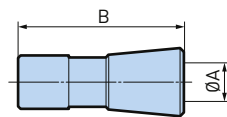

Model	Order No.	ØA	B
CA4-3	804.666	3	16.5
CA4-3.5	804.667	3.5	16.5
CA4-4	804.668	4	16.5
CA6-3	804.669	3	22
CA6-4	804.670	4	22
CA6-5	804.671	5	22
CA6-6	804.672	6	22

Mold Chuck Clamping Screw

For SSL



Model	Order No.	Clamping Screw	Contents of Set	Body
H06FSA	978.912	M6 P0.75	4.5mm x 1P, 5mm x 1P	SSL6
H06FSB	802.330	M6 P0.75	4.5mm x 1P, 6mm x 1P	SSL8, 10
H08FSA	979.976	M8 P0.75	6mm x 2P, 8mm x 1P	SSL12
H08FSB	804.783	M8 P0.75	6mm x 1P, 8mm x 1P, 10mm x 1P	SSL16, 20
H0304FS-2P	978.914	M3 P0.5	4mm x 2P	SSL3
H0404FS-2P	801.045	M4 P0.5	4mm x 2P	SSL4

Tooling Mate

For BBT (BT) and BDV (DV)

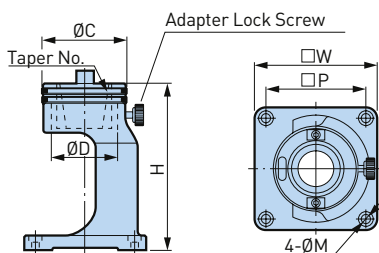

Replaceable Adapter

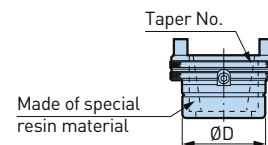

Model	Order No.	Taper	ØD	ØC	ØM	H	W	P	Adapter
TMS40-20	805.489	ISO20	60	76	7	150	110	90	TMA40-20
TMS40-30	961.270	BT30 / DV30	60	76	7	150	110	90	TMA40-30
TMS40-40	961.271	BT40 / DV40	60	76	7	150	110	90	TMA40-40
TMS50-40	961.272	BT40 / DV40	88	105	9	190	160	130	TMA50-40
TMS50-50	961.273	BT50 / DV50	88	105	9	190	160	130	TMA50-50

1. 1 pce. of adapter is included.
2. Adapter can be ordered individually.

Tooling Mate

For HSK and BIG CAPTO

Innovative "Two-way clutch needle roller clamping system" assures secure clamping.

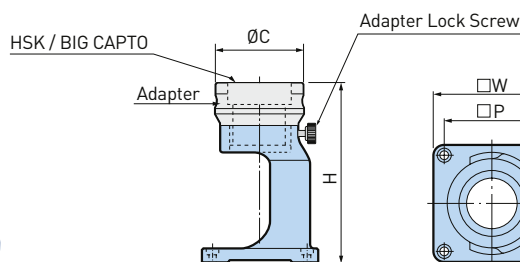

Fig. 1

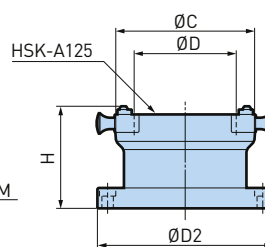
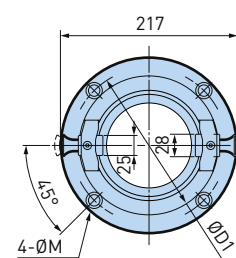

Fig. 2



Model	Order No.	Fig.	HSK No.	BIG CAPTO	ØD	ØD1	ØD2	ØC	ØM	H	W	P	Adapter
TMS40-32R	961.339	1	32	C3	-	-	-	76	7	165	110	90	TMA40-32R
TMS40-40R	961.342	1	40	C4	-	-	-	76	7	165	110	90	TMA40-40R
TMS40-50R	961.346	1	50	C5	-	-	-	76	7	165	110	90	TMA40-50R
TMS40-63R	961.338	1	63	C6	-	-	-	87	7	172	110	90	TMA40-63R
TMS50-80R	802.308	1	80	C8	-	-	-	114	9	215	160	130	TMA50-80R
TMS50-100R	802.307	1	100	-	-	-	-	124	9	219	160	130	TMA50-100R
TMS-HSK-A125	806.795	2	125	-	125	190	215	170	13	125	-	-	-

1. 1 pce. of adapter is included.
2. Adapter can be ordered individually.

Accessories & Spare Parts

Tooling Mate / Torque Fit Adapter



► 369

Kombi Grip

For HSK and BIG CAPTO

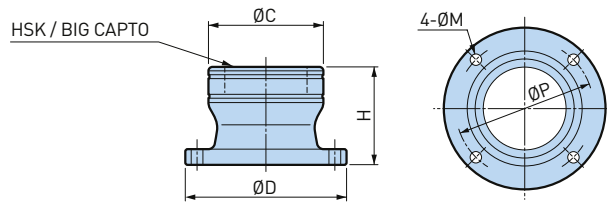

Model	Order No.	HSK No.	BIG CAPTO	ØD	ØP	ØC	ØM	H
KG25R	961.291	25	-	79	62	48	7	65
KG32R	961.292	32	C3	85	69	55	7	65
KG40R	961.293	40	C4	93	77	63	7	70
KG50R	961.294	50	C5	105	89	75	7	70
KG63R	961.295	63	C6	123.5	105,5	88	9	75
KG80R	961.296	80	C8	142	124	107	9	90
KG100R	961.297	100	-	162	124	127	9	100

A.8

1. Mounting screws are not included.

Assembling unit ST Lock

Fixes cylindrical shank tools, ideal for tightening nuts.

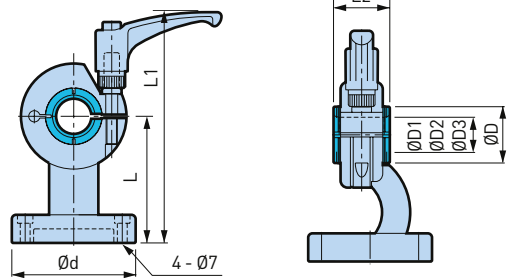

Model	Order No.	Ød	ØD	ØD1	ØD2	ØD3	L	L1	L2
STL40	978.037	88	40	20	25	32	90	164	40

1. 20 / 25 / 32mm sleeves are included to clamp cylindrical shank diameters, HSK-E20, HSK-E25 and HSK-E32.

Torque Fit

Tooling fixture with integrated tightening torque measurement.

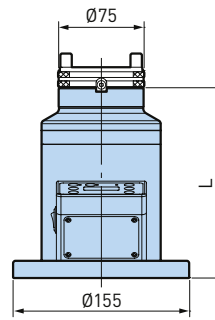

Fig. 1

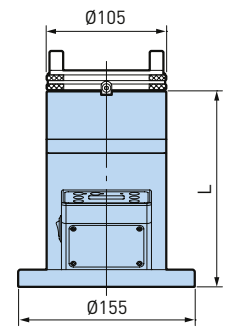
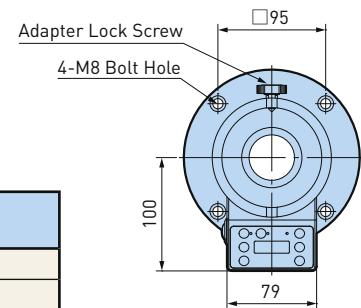

Fig. 2

- Torque values of all BIG collet chucks are presetted.
- Notification by buzzer near the correct torque.
- USER-Mode allows setting of desired torque value.

Model	Order No.	Fig.	L	Adapter	Nm range	Input Voltage
TF-40	806.737	1	167	TMA40	4 - 80 Nm	100 - 240V
TF-50	806.738	2	172	TMA50	4 - 80 Nm	100 - 240V

1. Adapter is to be ordered separately.



A.8

Tooling Mate / Torque Fit Adapter

For BT/DV

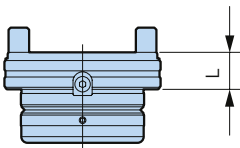

Model	Order No.	Taper	L
TMA40-20	805.894	ISO20	18
TMA40-30	802.944	BT30 / DV30	18
TMA40-40	802.945	BT40 / DV40	18
TMA50-40	802.942	BT40 / DV40	18
TMA50-50	802.943	BT50 / DV50	18

Tooling Mate / Torque Fit Adapter

For HSK/BIG CAPTO

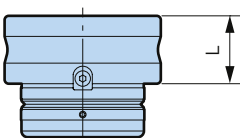

Model	Order No.	HSK No.	BIG CAPTO	L
TMA40-32R	802.948	32	C3	33
TMA40-40R	802.949	40	C4	33
TMA40-50R	802.950	50	C5	33
TMA40-63R	972.331	63	C6	40
TMA50-80R	802.946	80	C8	43
TMA50-100R	802.947	100	-	47

Wiper Cleaners

Perfect for Hydraulic Chuck and Shrink Fit Holder
Easy cleaning by simply inserting and removing.

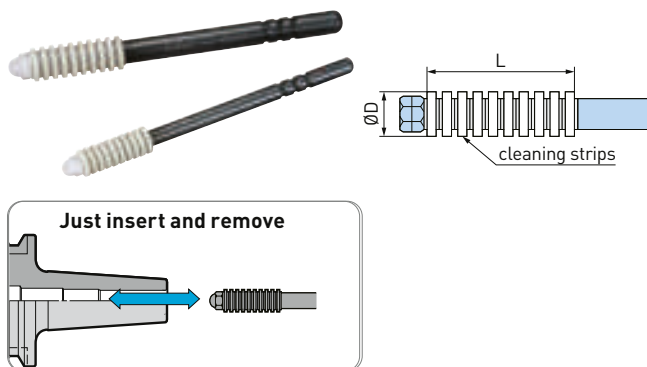

Model	Order No.	ØD	L
AWC3	978.898	3	7
AWC4	978.899	4	7
AWC5	978.900	5	20
AWC6	978.901	6	20
AWC7	802.781	7	20
AWC8	978.902	8	20
AWC9	802.782	9	26
AWC10	978.903	10	26
AWC11	802.783	11	31
AWC12	978.904	12	31

1. ØD is the inner bore of correspondent tool holders.

TK Cleaners

Perfect for Hydraulic Chuck and Milling Chuck Holder
Absolute cleaning of clamping bore by unique "slide" feature.

A.8

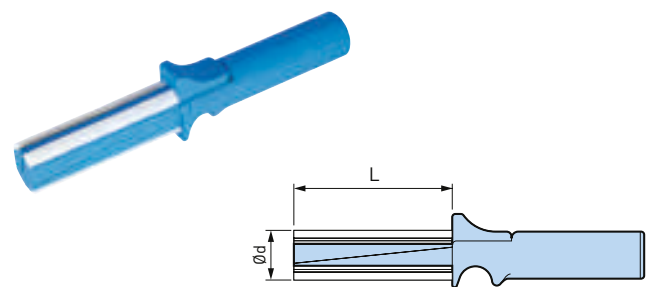

Model	Order No.	Ød	L	Leather Strips Qty.
TKC14	802.805	14	60	2
TKC16	802.807	16	70	2
TKC18	802.808	18	70	2
TKC20	802.809	20	70	2
TKC25	802.810	25	80	3
TKC32	802.811	32	100	4
TKC40	802.812	40	105	4
TKC42	978.905	42	105	4

Taper Cleaners



For MEGA Micro Chuck

Model	Order No.	Suitable for model
SC-NBC3S	961.278	MEGA3S
SC-NBC4S	961.279	MEGA4S
SC-NBC6S	961.280	MEGA6S
SC-NBC8S	805.827	MEGA8S

For MEGA E Chuck

Model	Order No.	Suitable for model
SC-MEC6	961.287	MEGA6E
SC-MEC8	961.288	MEGA8E
SC-MEC10	961.289	MEGA10E
SC-MEC13	961.290	MEGA13E

For MEGA New Baby Chuck and New Baby Chuck

Model	Order No.	Suitable for model
SC-NBC6	961.281	MEGA6N / NBS6
SC-NBC8	961.282	MEGA8N / NBS8
SC-NBC10	961.283	MEGA10N / NBS10
SC-NBC13	961.284	MEGA13N / NBS13
SC-NBC16	961.285	MEGA16N / NBS16
SC-NBC20	961.286	MEGA20N / NBS20

For ER Collet Chuck

Model	Order No.	Suitable for model
SC-MER11	967.810	MEGA ER 11
SC-MER16	967.811	MEGA ER 16
SC-MER20	967.812	MEGA ER 20
SC-MER25	967.813	MEGA ER 25
SC-MER32	967.814	MEGA ER 32

Tooling Cleaners

For tool shank taper and flange
 Particles and oil on both taper and flange of 7/24 taper holder are easily removed.

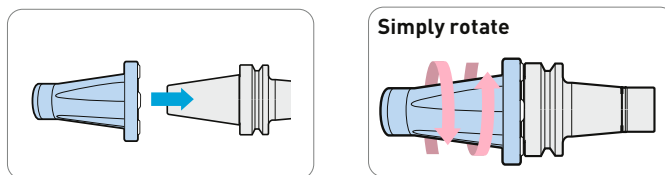

Model	Order No.	Taper
SCE-30	961.276	ISO 30
SCE-40	961.277	ISO 40

Spindle Cleaners

For machine spindle
 Easy cleaning of oil or particles from the machine spindle.



A.8



For ISO taper spindle

Model	Order No.	Taper
SC20	804.945	ISO 20
SC30	802.791	ISO 30
SC40	802.793	ISO 40
SC45	802.794	ISO 45
SC50	802.796	ISO 50



For Morse taper spindle

Model	Order No.	Taper
SC1	802.788	MT1
SC2	802.789	MT2
SC3	802.790	MT3
SC4	802.792	MT4
SC5	802.795	MT5
SC6	802.797	MT6



For HSK-A spindle

Model	Order No.	Taper
SC-HSK32	802.799	HSK-A32
SC-HSK40	979.997	HSK-A40
SC-HSK50	802.800	HSK-A50
SC-HSK63	802.802	HSK-A63
SC-HSK80	802.803	HSK-A80
SC-HSK100	802.798	HSK-A100

For HSK-E spindle

Model	Order No.	Taper
SC-HSK25E	979.995	HSK-E25
SC-HSK32E	979.996	HSK-E32
SC-HSK40E	979.998	HSK-E40
SC-HSK50E	802.801	HSK-E50

Spindle Cleaners

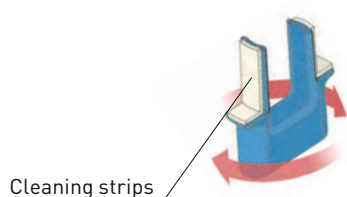

Cleaning strips

For BIG CAPTO

Model	Order No.	BIG CAPTO
SC-C3	973.194	C3
SC-C4	973.195	C4
SC-C5	973.196	C5
SC-C6	973.197	C6
SC-C8	973.198	C8

Flange Face Cleaner (BBT)

Cleans the spindle flange face.

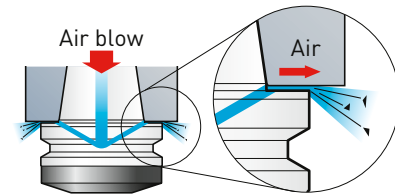
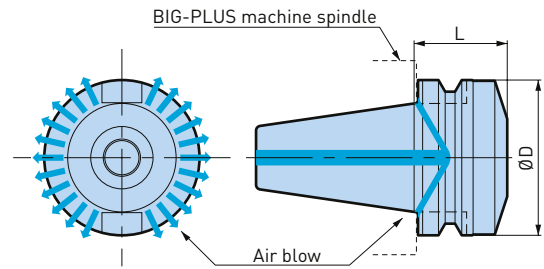

A.8

Model	Order No.	ØD	L
SBT30-ASC-30T	802.777	46	30
SBT40-ASC-40T	802.778	63	40
SBT50-ASC-60T	978.150	100	60

Flange Face Cleaner (BDV)

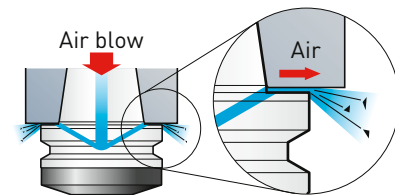
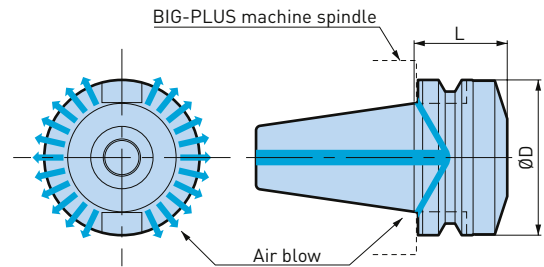

Model	Order No.	ØD	L
SDV40-ASC-40T	805.647	45	40
SDV50-ASC-60T	801.670	70	60

T-Slot Clean

Improve efficiency of table cleaning. No T-slots packed with swarf anymore!

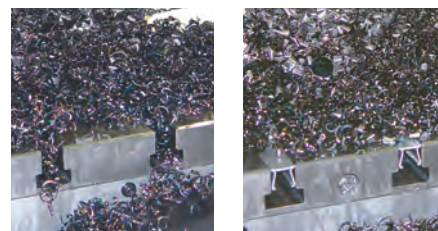

Before

After

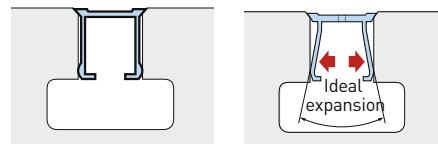

Other manufacturer

BIG KAISER

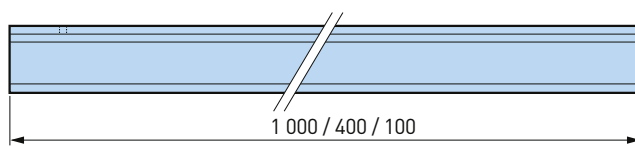
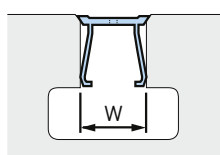

Due to the uniquely angled shape of the table T-shot contact part, slipout is prevented and chips are completely shut out.

A.8

Model	Order No.	W	Contents of Set
TS14-S	961.252	14	400 mm x 4 pieces, 100 mm x 4 pieces, Removal pin x 1 piece
TS18-S	961.253	18	400 mm x 4 pieces, 100 mm x 4 pieces, Removal pin x 1 piece
TS22-S	961.254	22	400 mm x 4 pieces, 100 mm x 4 pieces, Removal pin x 1 piece
TS14-400L-100P	961.255	14	400 mm x 100 pieces, Removal pin x 10 pieces
TS18-400L-100P	961.256	18	400 mm x 100 pieces, Removal pin x 10 pieces
TS22-400L-100P	961.257	22	400 mm x 100 pieces, Removal pin x 10 pieces
TS18-1000L-10P	802.785	18	1000 mm x 10 pieces, Removal pin x 1 piece
TS22-1000L-10P	802.787	22	1000 mm x 10 pieces, Removal pin x 1 piece

Chip Fan

Remove chips and coolant from tools without interrupting production.

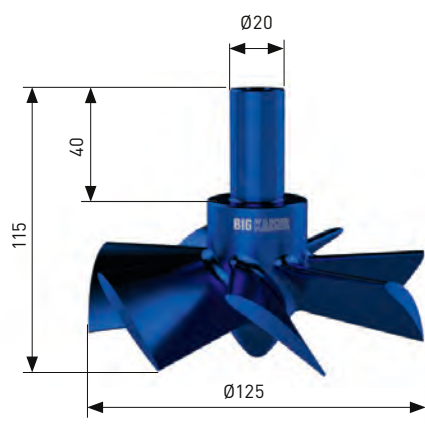

Model	Order No.	Number of Wings
ST20-CF125	335.625	7

Pullstud Bolts

Before ordering:

Ensure to check the dimensions of the required pullstud bolt by referring to the specification sheet of the machine tool. In the case of machines with coolant-through-spindle capability especially, provide a copy of the pullstud bolt drawing.

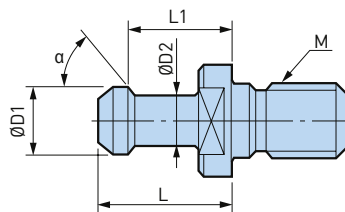

Fig. 1

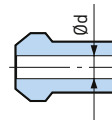

Fig. 2

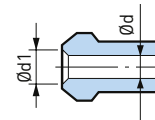

Fig. 3

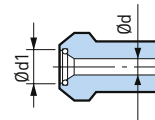

Fig. 4

Model	Order No.	Taper	Fig.	Ød	Ød1	ØD1	ØD2	L	L1	α	standard	Techn. data / special features
30P-1MGH	978.951	ISO 30	2	4	-	11	8	23	18	45	Original	FANUC
30PMG	978.956	ISO 30	1	-	-	12	8	23.4	18.4	75	JIS	JIS BT30
30PMGH	978.972	ISO 30	2	4	-	12	8	23.4	18.4	75	JIS	JIS 30 with bore
30PMGH2	800.450	ISO 30	4	2.5	5.5	12	8	23.4	18.4	75	JIS	YASDA
P30T-1MG	978.978	ISO 30	1	-	-	11	7	23	18	45	MAS-l	MAS-1 BT30
P30T-1MGH	978.953	ISO 30	2	2.5	-	11	7	23	18	45	MAS-l	MAS-1 BT30 with bore
P30T-2MG	978.979	ISO 30	1	-	-	11	7	23	18	60	MAS-ll	MAS-2 BT30
P30T-2MGH	801.785	ISO 30	2	2.5	-	11	7	23	18	60	MAS-ll	MAS-2 BT30 with bore
P30T-2MGH3	801.787	ISO 30	2	2.5	-	11	7.5	23	18	60	Original	BROTHER
PMO30MG	802.001	ISO 30	4	2.5	6.5	11	7	23	18	45	Original	DMG MORI

Model	Order No.	Taper	Fig.	Ød	Ød1	ØD1	ØD2	L	L1	α	standard	Techn. data / special features
40PMG	800.463	ISO 40	1	-	-	19	14	29	23	75	JIS	JIS BT40
40PMGH	978.954	ISO 40	2	7	-	19	14	29	23	75	JIS	JIS BT40 with hole
40PMGH2	800.464	ISO 40	2	7	-	19	14	29	23	75	JIS	MAKINO (Face side G) *
40PMGH4A	978.955	ISO 40	2	7	-	19	14	29	23	75	JIS	YASDA Ø3 Side bore
40PMGH7	978.958	ISO 40	3	4	5	19	14	29	23	75	JIS	OKUMA (Face side G) *
40PMGH11	978.977	ISO 40	4	7	10	19	14	29	23	75	JIS	YASDA
40PMGH12	805.885	ISO 40	2	5	-	19	14	29	23	75	JIS	MITSUI
MP40MG	801.507	ISO 40	1	-	-	15	10	25	18	90	Original	MITSUI
P40T-1MG	801.807	ISO 40	1	-	-	15	10	35	28	45	MAS-l	MAS-1 BT40
P40T-1MGH1	801.808	ISO 40	3	3.5	5.5	15	10	35	28	45	MAS-l	MAS-2 BT40
P40T-1MGH4	801.810	ISO 40	4	3	7	15	10	35	28	45	MAS-l	OKUMA
P40T-1MGH7	801.812	ISO 40	2	4	-	15	10	35	28	45	MAS-l	MAKINO (Face side G) *
P40T-1MGH8A	801.813	ISO 40	4	3	7	15	10	35	28	45	MAS-l	JTEKT
P40T-1MGHA	801.814	ISO 40	2	3	-	15	10	35	28	45	MAS-l	MAS-1 BT40 with bore
P40T-2MG	801.831	ISO 40	1	-	-	15	10	35	28	60	MAS-ll	MAS-2 BT40
P40T-2MGH1	801.832	ISO 40	4	3	7	15	10	35	28	60	MAS-ll	OKUMA
P40T-2MGH8	801.833	ISO 40	3	3.5	5.5	15	10	35	28	60	MAS-ll	MAS-2 BT40 with bore
P40T-2MGHA	801.834	ISO 40	2	3	-	15	10	35	28	60	MAS-ll	MAS-2 BT40 with bore
PMO40MG	978.971	ISO 40	4	7	10	19	14	29	23	75	Original	DMG MORI with bore
POM40MG	802.023	ISO 40	1	-	-	15	10	35	28	90	Original	DMG MORI without bore
PVD40MG	978.975	ISO 40	2	7	-	19	14	26	20	75	DIN	DIN 69872 from A
PYN40MG	802.112	ISO 40	2	7	-	18.8	12.45	19.11	14.03	45	Original	MAZAK

MEGA Pullstud Bolt

MG in the model numbers stand for MEGA Pullstud Bolt. Tensile strength is improved by utilizing tool steel. Especially recommended for the BIG-PLUS dual contact applications. [Material: X40CrMOV51]

For
BBT30, BT30



For
BBT40, BT40



For
BBT50, BT50



Please scan QR Code for details

Model	Order No.	Taper	Fig.	Ød	Ød1	ØD1	ØD2	L	L1	α	standard	Techn. data / special features
50PH	978.965	ISO 50	2	10	-	28	21	34	25	75	JIS	JIS 50 with bore
50PH2	800.468	ISO 50	2	10	-	28	21	34	25	75	JIS	MAKINO (Face side G) *
50PMGH	800.472	ISO 50	2	10	-	28	21	34	25	75	JIS	JIS 50 with bore
MP50	801.509	ISO 50	1	-	-	24	18	31	23	90	Original	MITSUBI
MP50H1	801.517	ISO 50	2	8	-	24	18	31	23	90	Original	MITSUBI with bore
P50T-1	961.331	ISO 50	1	-	-	23	17	45	35	45	MAS-l	MAS-1 BT50
P50T-1H	801.860	ISO 50	2	8	-	23	17	45	35	45	MAS-l	MAS-1 BT50 with bore
P50T-1H1	801.861	ISO 50	2	6	-	23	17	45	35	45	MAS-l	MAKINO (Face side G) *
P50T-1H4	801.873	ISO 50	4	6	10.4	23	17	45	35	45	MAS-l	JTEKT
P50T-1H5	961.332	ISO 50	4	5.5	11.2	23	17	45	35	45	MAS-l	YASDA
P50T-1H8	801.876	ISO 50	4	8	11	23	17	45	35	45	MAS-l	DMG MORI (Face G) *
P50T-1H19	801.868	ISO 50	2	4.5	-	23	17	45	35	45	MAS-l	TOSHIBA
P50T-1MG	801.883	ISO 50	1	-	-	23	17	45	35	45	MAS-l	MAS-1 BT50
P50T-1MGH	801.885	ISO 50	2	6	-	23	17	45	35	45	MAS-l	MAS-1 BT50 with bore
P50T-1MGH25	801.889	ISO 50	2	6	7	23	17	45	35	45	MAS-l	OKUMA (Face side G) *
P50T-2	801.898	ISO 50	1	-	-	23	17	45	35	60	MAS-ll	MAS-2 BT50
P50T-2H	801.925	ISO 50	2	8	-	23	17	45	35	60	MAS-ll	MAS-2 BT50 with bore
P50T-2H4	801.938	ISO 50	4	8	11	23	17	45	35	60	MAS-ll	DMG MORI (Face G) *
P50T-2H11	801.927	ISO 50	4	6	9.5	23	17	45	35	60	MAS-ll	OKUMA
P50T-2H14	801.929	ISO 50	3	6	7	23	17	45	35	60	MAS-ll	OKUMA (Face side G) *
P50T-2H15	801.930	ISO 50	4	6	10.4	23	17	45	35	60	MAS-ll	JTEKT
P50T-2H16	801.931	ISO 50	4	5.5	11.2	23	17	45	35	60	MAS-ll	YASDA
P50T-2MG	801.942	ISO 50	1	-	-	23	17	45	35	60	MAS-ll	MAS-2 BT50
P50T-2MGH14	801.944	ISO 50	3	6	7	23	17	45	35	60	MAS-ll	OKUMA (Face side G) *
P50T-2MGH25	801.948	ISO 50	2	6	-	23	17	45	35	60	MAS-ll	MAS-2 BT50
POM50	978.967	ISO 50	1	-	-	23	17	45	35	90	Original	DMG MORI
POM50H	961.336	ISO 50	4	8	-	23	17	45	35	90	Original	DMG MORI with bore
POM50H1	961.333	ISO 50	2	8	12.4	23	17	45	35	90	Original	DMG MORI with bore
POM50H8	802.046	ISO 50	2	6	-	23	17	45	35	90	Original	OKK (Face side O) **
PVD50	978.966	ISO 50	2	11.5	-	28	21	34	25	75	DIN	DIN 69872 from A
PYN50-5	802.120	ISO 50	2	10	-	28.83	20.83	25.2	17.58	45	Original	MAZAK (Face side G) *

1. Machine tool builders have used many various shapes and sizes of pull stud bolts.
2. The use of the incorrect bolts may result in injury or property damage for your machining center.
3. Other sizes are also available. Contact BIG KAISER agent for pullstud bolts.
4. * End face was ground for sealing.
5. **End face has O-ring for sealing.

Pullstud Wrenches

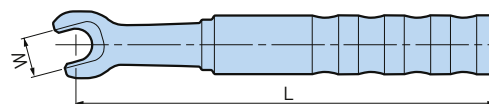

Model	Order No.	L	W	Taper Size	Suitable for model
PLW30	805.544	140	13	BBT30 / BT30	30P-, P30T-1, P30T-2, POM30
PLW-40P	805.886	200	19	BBT40 / BT40	40P-
PLW-P40T	805.887	200	19	BBT40 / BT40	P40T-1, P40T-2, POM40-
PLW-PMO40	805.888	200	19	BBT40 / BT40	PMO40-
PLW-PYN40	805.889	200	19	BBT40 / BT40	PYN40-
PLW-P50T	807.473	350	30	BBT50 / BT50	P50T-1, P50T-2, POM50-
PLW-PYN50	807.474	350	30	BBT50 / BT50	PYN50-

Set Up Information



Preparing the Stop Block

The Angle Head utilizes a Locating Pin that engages with the Stop Block, which is mounted to the machine spindle to prevent radial movement of the Angle Head during operation. Therefore, it is necessary to use a Stop Block with the proper dimensions to match the Locating Pin of the Angle Head.

1. Standard Setup of the Locating Pin

“S” Dimension

The distance from the centerline of the Angle Head spindle to the centerline of the Locating Pin.

Fixed Length “A” and “H”

The axial distance from the gauge line to the top of the Locating Pin, when the Locating Pin is properly engaged in the Stop Block.

Fixed Length “A” for Angle Head (Fig.1)

This is not adjustable by the customer. If the standard dimensional values shown below are not suitable for your machine, please contact us.

Fixed Length “H” for Air Turbine spindle and High Spindle (Fig.2)

We will deliver a set at the standard 6 mm. Otherwise, This dimension is adjustable by the customer. Four (4) Locating Pin models are available, please contact us.

A.8

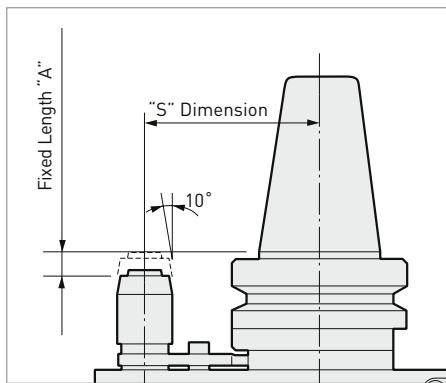

Fig. 1

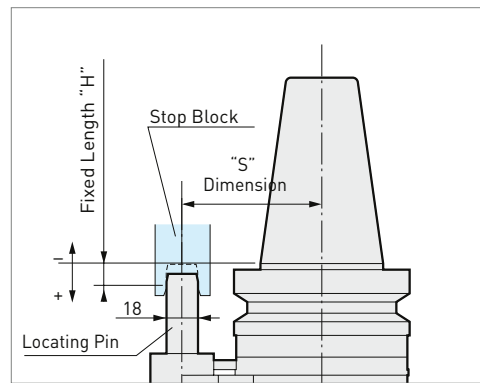

Fig. 2

Standard Dimension	Angle Head Fig. 1		Air Turbine and High Spindle Fig. 2	
	“S”	“A”	“S”	“H”
BDV40 / BBT40 / HSK-A63	65	8	65	6
BDV50 / BBT50 / HSK-A100	80	8	80	6
	110	6		

2. Stop Block Dimensions

Please order a Stop Block from the machine tool builder. Refer to the following diagrams for the proper Stop Block groove dimensions.



Stop Block

For “S” = 110 Angle Head

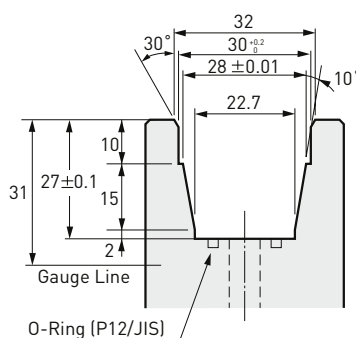

Others

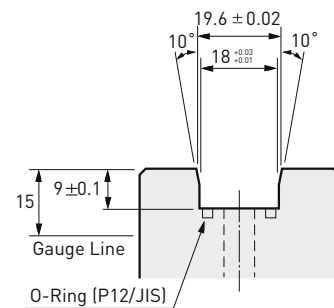

Semi-Finished Stop Blocks

A semi-finished Stop Block has the proper groove form for use with the Angle Head, as well as additional material to allow the user to machine the block to the correct height. If a pre-made Stop Block is unobtainable from the machine tool builder, a semi-finished Stop Block can be used. Please consult with the machine tool builder for selection, machining, and mounting of a semi-finished Stop Block.

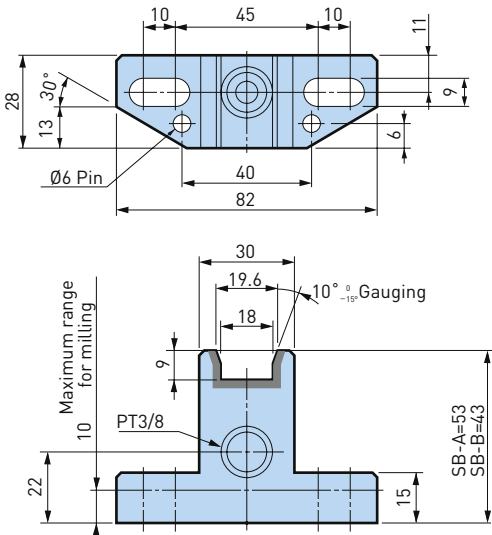

Fig. 1

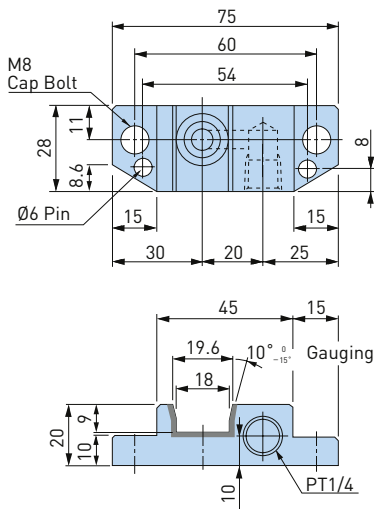

Fig. 2

Model	Order No.	Fig.
SB-A	962.571	1
SB-B	962.572	1
SB-F	962.574	2
SB-G/E	802.329	3

1. "S" is corresponding to previous page.
2. SB-F is not adjustable in height.

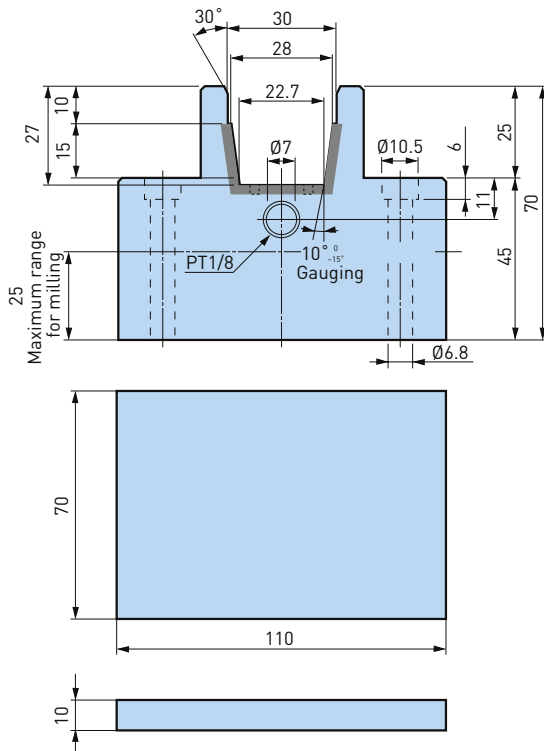

Fig. 3

Rough Boring Heads

Overview	380
Application Examples for SW	381
MW Rough Boring Heads	382
SW Rough Boring Heads	383
SW-AL Rough Boring Heads	384
SW Smart Damper Rough Boring Heads	385
SW Rough Boring Heads BIG CAPTO	386
Insert Holders for SW	387
Face Grooving Holders for SW	392
Guidelines & Troubleshooting	393



MW Rough Boring Head

Small and powerful rough boring head: The MW comes with cylindrical shank and permits extremely fast roughing of small holes.

Ø 16 - 21 mm



SW Rough Boring Head

Super-versatile rough boring head for highest cutting performance: Thanks to its clever design, the SW can be used for stepped and balances roughing by simply switching the insert holders. Various accessories are available for chamfering, back boring and face grooving.

Ø 20 - 203 mm, CKB1-CKB7 and CKN6-CKN7

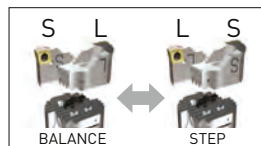

B.1



SW-AL Rough Boring Head

The fastest solution for deep roughing: SW-AL, built of high quality aluminum, fits perfectly on CKN components. Long tool combinations are therefore up to 50% lighter than similar tools built of steel which enhances the productivity drastically.

Ø 68 - 203 mm, CKN6-CKN7

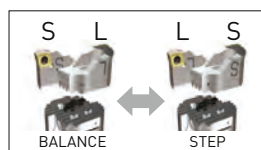

SW Smart Damper Rough Boring Head

The solution for vibration-free rough boring. Its built-in patented Smart Damper technology is located close to the cutting edge and lifts the performance of rough boring on a new level.

Ø 41 - 100 mm, CKB4-CKB6



The Rough Boring Head TWN series will be removed from the BIG KAISER product range as of December 31, 2022.



The current articles will continue to be available until the end of the year.

Application Examples for SW

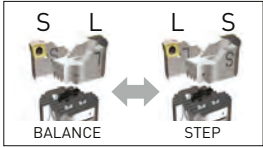

Rough Boring Balance

Insert Holders: Type CC/SP/SC
 Ø 20 - 203 mm
 High feed rates

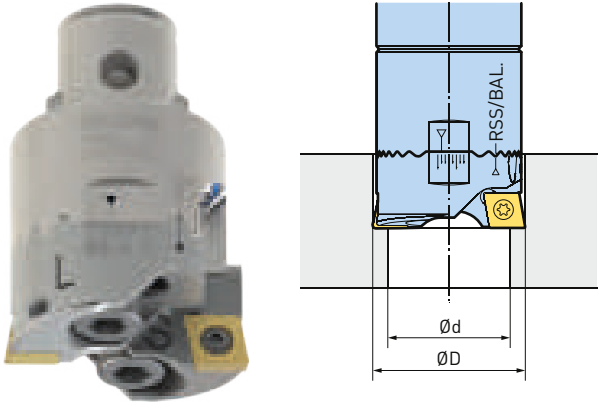

Application Examples for SW

Rough Boring Step

Insert Holders: Type CC
 Ø 20 - 203 mm
 Double stock removal, half the feed rate

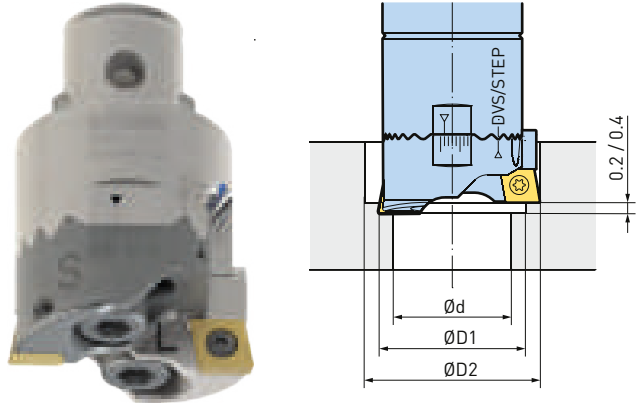

Application Examples for SW

B.1

Chamfering

Ø 30 - 210 mm
 Adjustable chamfer angle 15° - 75°

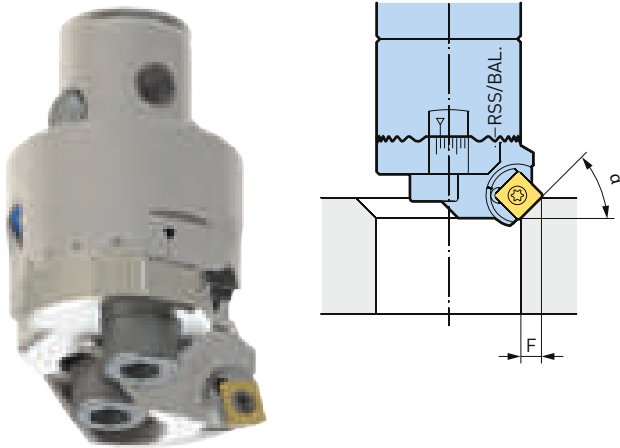

Back Boring

Ø 44 - 211 mm
 Lead angle 90°

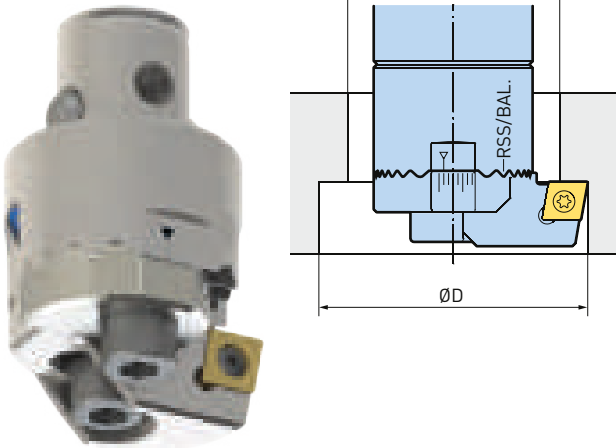

MW Rough Boring Heads, Ø 16 - 21

The MW rough boring heads permit extremely fast roughing of small holes (Ø 16-21 mm).

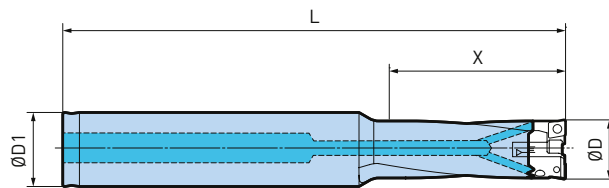

Rough Boring
Blind holes



Rough Boring
Through holes

Model	Order No.	ØD	ØD1	L	X
ST20-MW1619-45	807.540	16 - 19	20	136	45
ST20-MW1619-60	472.051	16 - 19	20	150	60
ST20-MW1821-50	807.541	18 - 21	20	141	50
ST20-MW1821-65	472.061	18 - 21	20	155	65

1. Insert holder is to be ordered separately.

MW Rough Boring Heads, Ø 16 - 21 Carbide

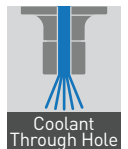

B.1

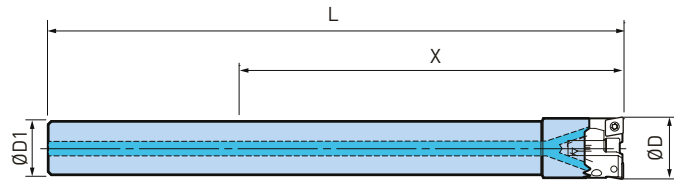

Model	Order No.	ØD	ØD1	L	X
ST14W-MW16-110	807.552	16 - 19	14	151	110
ST16W-MW18-115	807.553	18 - 21	16	172	115

1. Insert holder is to be ordered separately.
2. Exclusive use for through holes. Do not use with blind holes.

Insert Holders MW



Accessories & Spare Parts

Insert Holders MW	Inserts MW
<p>► 382</p>	<p>► 475</p>

Model	Order No.	ØD	X	Insert
MW1619E	472.052	68 - 90	64	MW 04
MW1821E	472.062	88 - 110	72	MW 04

1. Consisting of two insert holders, clamping screws and wrench.
2. Inserts are to be ordered separately.

SW Rough Boring Heads, Ø 20 - 203

The short and compact design of the components combined with a positive and friction locked connection between the tool body and insert holders provide maximum rigidity and highest cutting performance.

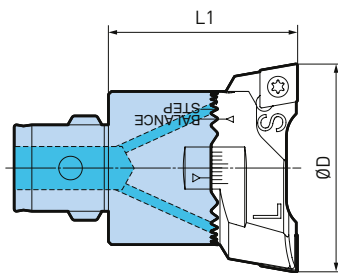
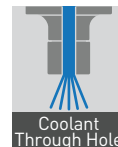

RSS: Balance Cut

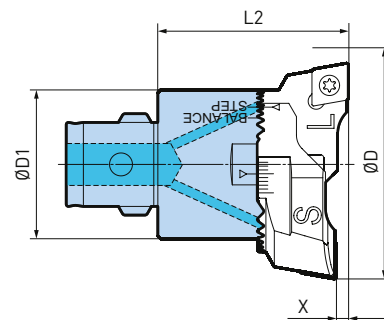

DVS: Step Cut

Model	Order No.	CK	ØD	ØD1	L1	L2	X
SW20-31CKB1	319.101	CKB1	20 - 31	19	32.5	32.6	0.2
SW25-40CKB2	319.201	CKB2	25 - 40	24	35.5	35.6	0.2
SW32-51CKB3	319.301	CKB3	32 - 51	31	40	40.1	0.2
SW41-66CKB4	319.401	CKB4	41 - 66	39	47	47.2	0.4
SW53-86CKB5	319.501	CKB5	53 - 86	50	57	57.2	0.4
SW68-110CKB6	319.601	CKB6	68 - 110	63.5	71	71.2	0.4
SW68-110CKN6	319.601N	CKN6	68 - 110	63.5	71	71.2	0.4
SW98-153CKN6	319.602N	CKN6	98 - 153	90	71	71.2	0.4
SW98-153CKB6	319.602	CKB6	98 - 153	90	71	71.2	0.4
SW148-203CKB6	319.603	CKB6	148 - 203	140	71	71.2	0.4
SW148-203CKN6	319.603N	CKN6	148 - 203	140	71	71.2	0.4
SW148-203CKB7	319.703	CKB7	148 - 203	140	117	117.2	0.4
SW148-203CKN7	319.703N	CKN7	148 - 203	140	117	117.2	0.4
SW98-153CKB7-87	319.701	CKB7	98 - 153	90	87	87.2	0.4
SW98-153CKN7-87	319.701N	CKN7	98 - 153	90	87	87.2	0.4
SW98-153CKB7-117	319.702	CKB7	98 - 153	90	117	117.2	0.4
SW98-153CKN7-117	319.702N	CKN7	98 - 153	90	117	117.2	0.4

1. X = difference length of insert holders for DVS step rough boring
2. For information on CKN and CKB connections, kindly see next page

B.1

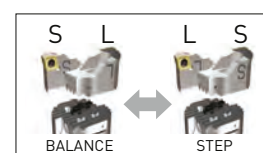

Accessories & Spare Parts

Insert Holders Type CC	Insert Holders Type SC/SP	Insert Holders Type WC	Insert Holders Chamfering for SW	Insert Holders Back Boring for SW
▶ 387	▶ 388	▶ 389	▶ 390	▶ 391

SW-AL Rough Boring Heads, Ø 68 - 203

Tool body made of high strength aluminium with CKN connection.

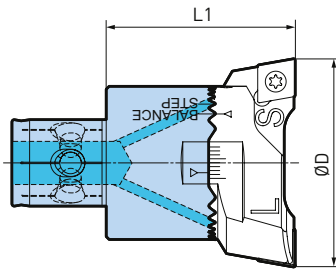

RSS: Balance Cut

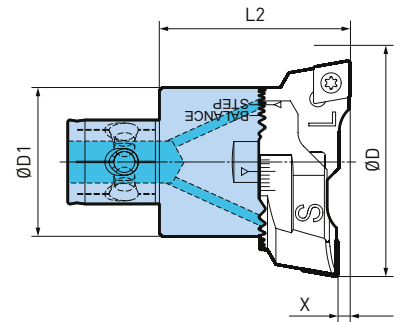

DVS: Step Cut

Model	Order No.	CK	ØD	ØD1	L1	L2	X
SW68-110CKN6AL	319.604N	CKN6	68 - 110	63.5	71	71.2	0.4
SW98-153CKN6AL	319.605N	CKN6	98 - 153	90	71	71.2	0.4
SW148-203CKN6AL	319.607N	CKN6	148 - 203	140	71	71.2	0.4
SW148-203CKN7-AL	319.707N	CKN7	148 - 203	140	117	117.2	0.4
SW98-153CKN7-87AL	319.705N	CKN7	98 - 153	90	87	87.2	0.4
SW98-153CKN7-117AL	319.706N	CKN7	98 - 153	90	117	117.2	0.4

1. X = difference length of insert holders for DVS step rough boring

Exclusively made to fit on CKN components

B.1

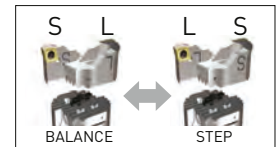

Difference CKB and CKN Connection

CKB: The most common CK connection with single clamping CK screw. Ideal for simple, efficient operations.

CKN: The most powerful CK connection with triple clamping CK screw. Ideal for long tool combinations and challenging operations. High interchange accuracy, less than 0.002 mm radial change error, is guaranteed.

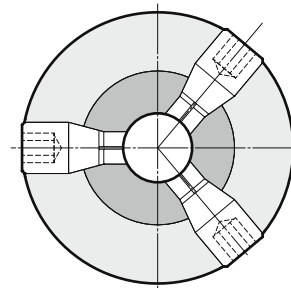
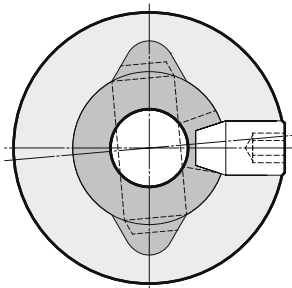

Accessories & Spare Parts

Insert Holders Type CC	Insert Holders Type SC/SP	Insert Holders Type WC	Insert Holders Chamfering for SW	Insert Holders Back Boring for SW
▶ 387	▶ 388	▶ 389	▶ 390	▶ 391

SW Smart Damper Rough Boring Heads, Ø 41 - 100

The boring head with dynamic damping unit reduces chatter.

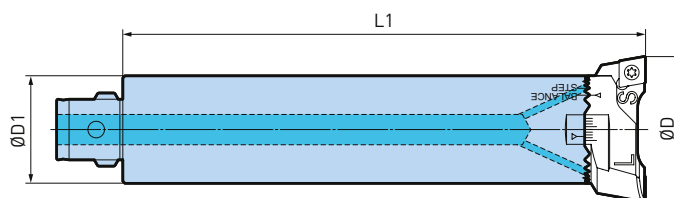
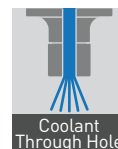

Model	Order No.	CK	ØD	ØD1	L1
CKB4-SW41DP-190	806.921	CKB4	41 - 66	39	190
CKB5-SW53DP-220	806.922	CKB5	53 - 86	50	220
CKB6-SW68DP-245	806.923	CKB6	68 - 110	64	245
CKB6-SW98DP-260	100042.001.0	CKB6	98 - 153	64	260
CKB6-SW148DP-260	100042.002.0	CKB6	148 - 203	64	260
CKB7-SW98DP-260	100042.003.0	CKB7	98 - 153	90	260
CKB7-SW148DP-260	100042.004.0	CKB7	148 - 203	90	260

B.1

Application Example

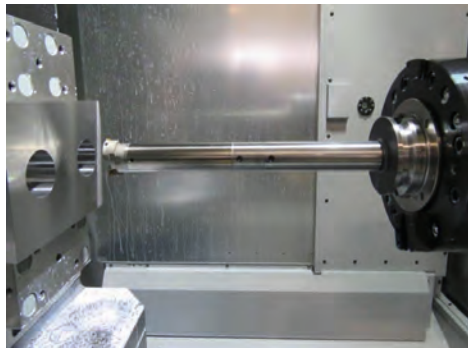

Horizontal Machine	
Smart Damper	SW41-66CKB4-200DP
Holder	BBT50-CKB4-178
Cutting Speed	200 m/min
D.O.C	Ø 4 mm
Feed	0.35 mm/rev
Coolant	Emulsion
Material	C55

Accessories & Spare Parts

<p>Insert Holders Type CC</p> <p>► 387</p>	<p>Insert Holders Type SC/SP</p> <p>► 388</p>
--	---

SW BIG CAPTO Rough Boring Heads, Ø 25 - 203

BIG CAPTO monobloc execution provide highest rigidity.

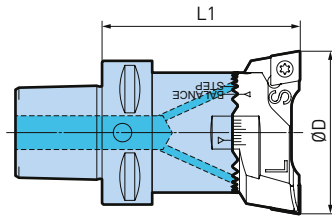

RSS: Balance Cut

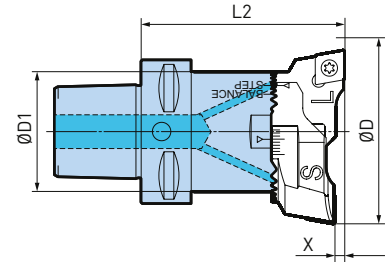

DVS: Step Cut

Model	Order No.	BIG CAPTO	ØD	ØD1	L1	L2	X
SW25-40C3	472.201	C3	25 - 40	24	80	80.1	0.2
SW32-51C3	472.301	C3	32 - 51	31	55	55.1	0.2
SW41-66C4	472.401	C4	41 - 66	39	67	67.2	0.4
SW53-86C5	472.501	C5	53 - 86	50	77	77.2	0.4
SW68-110C6	472.601	C6	68 - 110	63.5	92	92.2	0.4
SW98-153C6 *	472.602	C6	98 - 153	90	92.4	92.6	0.4
SW98-153C8	472.701	C8	98 - 153	90	117	117.2	0.4
SW148-203C8	472.703	C8	148 - 203	140	117	117.2	0.4

B.1

1. X = difference length of insert holders for DVS step rough boring
2. * Only on request, not available from stock.

Accessories & Spare Parts

Insert Holders Type CC	Insert Holders Type SC/SP	Insert Holders Type WC	Insert Holders Chamfering for SW	Insert Holders Back Boring for SW
				
▶ 387	▶ 388	▶ 389	▶ 390	▶ 391

Insert Holders Type CC

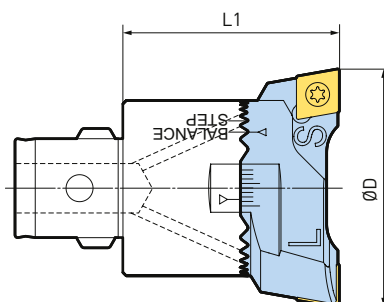

Standard insert holders for CC- type inserts with 90° lead angle.
 Suitable for balanced cut and Stepped Cut for through and blind holes.



Model	Order No.	Head	ØD	L1	Insert Holder S	Insert Holder L	Insert
IH1SW20C	639.413	SW20	20 - 26	32.5	639.411	639.412	CC 06
IH2SW20C	639.417	SW20	25 - 31	32.5	639.415	639.416	CC 06
IH1SW25C	639.423	SW25	25 - 33	35.5	639.421	639.422	CC 06
IH2SW25C	639.427	SW25	32 - 40	35.5	639.425	639.426	CC 06
IH1SW32C	639.433	SW32	32 - 42	40	639.431	639.432	CC 09
IH2SW32C	639.437	SW32	41 - 51	40	639.435	639.436	CC 09
IH1SW41C	639.443	SW41	41 - 54	47	639.441	639.442	CC 09
IH2SW41C	639.447	SW41	53 - 66	47	639.445	639.446	CC 09
IH1SW53C	639.453	SW53	53 - 70	57	639.451	639.452	CC 12
IH2SW53C	639.457	SW53	69 - 86	57	639.455	639.456	CC 12
IH1SW68C	639.463	SW68	68 - 90	71	639.461	639.462	CC 12
IH1SW68C16	639.563	SW68	68 - 90	71	639.561	639.562	CC 16
IH2SW68C	639.467	SW68	88 - 110	71	639.465	639.466	CC 12
IH2SW68C16	639.567	SW68	88 - 110	71	639.565	639.566	CC 16
IH1SW98C	639.473	SW98	98 - 126	71 / 87 / 117 *	639.471	639.472	CC 12
IH1SW98C16	639.573	SW98	98 - 126	71 / 87 / 117 *	639.571	639.572	CC 16
IH2SW98C	639.477	SW98	125 - 153	71 / 87 / 117 *	639.475	639.476	CC 12
IH2SW98C16	639.577	SW98	125 - 153	71 / 87 / 117 *	639.575	639.576	CC 16
IH1SW148C	639.483	SW148	148 - 176	71 / 117 *	639.481	639.482	CC 12
IH1SW148C16	639.583	SW148	148 - 176	71 / 117 *	639.581	639.582	CC 16
IH2SW148C	639.487	SW148	175 - 203	71 / 117 *	639.485	639.486	CC 12
IH2SW148C16	639.587	SW148	175 - 203	71 / 117 *	639.585	639.586	CC 16

1. Consisting of two insert holders with different lengths, type S (short) and L (long).
2. The insert holders are also available by the piece as spare parts.
3. * L1 depends on the length of the boring head.

Accessories & Spare Parts

Insert Holders Short CC	Insert Holders Long CC	Inserts CC
		
▶ 501	▶ 501	▶ 475

Insert Holders Type SC/SP

Inserts inclined 6° Balance cut for trough hole. Only for rotationally-symmetrical application (Balance cut).

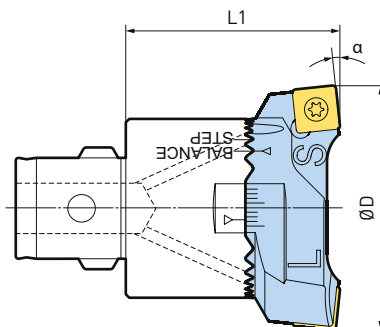

Model	Order No.	Head	ØD	L1	α	Insert Holder S	Insert Holder L	Insert
IH1SW20S	639.113	SW20	20 - 26	32.5	6°	639.111	639.112	SP 06
IH1SW25S	639.123	SW25	25 - 33	35.5	6°	639.121	639.122	SP 06
IH1SW32S	639.133	SW32	32 - 42	40	6°	639.131	639.132	SC 09
IH2SW32S	639.137	SW32	41 - 51	40	6°	639.135	639.136	SC 09
IH1SW41S	639.143	SW41	41 - 54	47	6°	639.141	639.142	SC 09
IH2W41S	639.147	SW41	53 - 66	47	6°	639.145	639.146	SC 09
IH1SW53S	639.153	SW53	53 - 70	57	6°	639.151	639.152	SC 12
IH2SW53S	639.157	SW53	69 - 86	57	6°	639.155	639.156	SC 12
IH1SW68S	639.163	SW68	68 - 90	71	6°	639.161	639.162	SC 12
IH2SW68S	639.167	SW68	88 - 110	71	6°	639.165	639.166	SC 12
IH1SW98S	639.173	SW98	98 - 126	71 / 87 / 117 *	6°	639.171	639.172	SC 12
IH2SW98S	639.177	SW98	125 - 153	71 / 87 / 117 *	6°	639.175	639.176	SC 12
IH1SW148S	639.183	SW148	148 - 176	71 / 117 *	6°	639.181	639.182	SC 12
IH2SW148S	639.187	SW148	175 - 203	71 / 117 *	6°	639.185	639.186	SC 12

B.1

1. Consisting of two insert holders with different lengths, type S (short) and L (long).
2. The insert holders are also available by the piece as spare parts.
3. * L1 depends on the length of the boring head.

Accessories & Spare Parts

Insert Holders Short SC-SP	Insert Holders Long SC-SP	Inserts SC	Inserts SP
			
▶ 501	▶ 501	▶ 480	▶ 479

Insert Holders Type WC

Full profile roughing permits boring with balance cut for large stroke with allowances (30 mm and more in Ø) in a single operation with relatively low drive power.

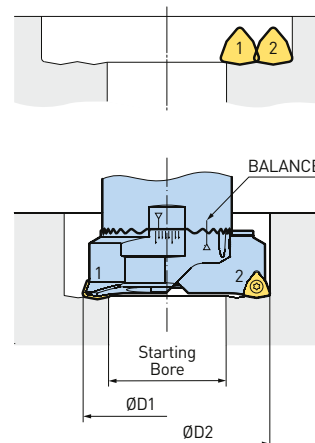
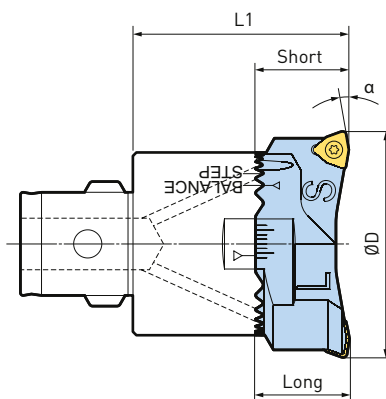

Model	Order No.	Head	ØD	L1	α	Insert Holder S	Insert Holder L	Insert
IH1SW41W	639.243	SW41	49 - 62	47	10°	639.241	639.242	WC 04
IH1SW53W	639.253	SW53	59 - 76	57	10°	639.251	639.252	WC 05
IH2SW53W	639.257	SW53	69 - 86	57	10°	639.255	639.252	WC 05
IH1SW68W	639.263	SW68	73 - 95	71	10°	639.261	639.262	WC 06
IH2SW68W	639.267	SW68	90 - 112	71	10°	639.265	639.266	WC 06
IH1SW98W	639.273	SW98	106 - 134	71 / 87 / 117 *	10°	639.271	639.272	WC 06
IH2SW98W	639.277	SW98	131 - 159	71 / 87 / 117 *	10°	639.275	639.276	WC 06
IH1SW148W	639.283	SW148	156 - 184	71 / 117 *	10°	639.281	639.282	WC 06
IH2SW148W	639.287	SW148	191 - 209	71 / 117 *	10°	639.285	639.286	WC 06

1. Consisting of two insert holders with different lengths, type S (short) and L (long).
2. The insert holders are also available by the piece as spare parts.
3. * L1 depends on the length of the boring head.

B.1

For Boring Head	Insert Holder Order No.	Starting Bore Ø	ØD1	ØD2
SW41	639.243	35 - 37.9	49	51 - 62
		38 - 41	52	54 - 62
SW53	639.253	41 - 44.9	59	61 - 76
		45 - 50	63	65 - 76
	639.257	51 - 54.9	69	76 - 86
		55 - 60	73	81 - 86
SW68	639.263	50 - 55.9	73	75 - 93
		56 - 61.9	79	81 - 93
		62 - 67	85	87 - 93
	639.267	67 - 72.9	90	92 - 110
		73 - 78.9	96	98 - 110
		79 - 85	102	104 - 110

For Boring Head	Insert Holder Order No.	Starting Bore Ø	ØD1	ØD2
SW98	639.273	84 - 89.9	107	109 - 129
		90 - 95.9	113	115 - 133
		96 - 102.9	119	121 - 133
		103 - 109	126	128 - 133
	639.277	108 - 114.9	131	133 - 154
		115 - 121.9	138	140 - 159
SW148	639.283	122 - 128.9	145	147 - 159
		129 - 135	152	154 - 159
		134 - 139.9	157	159 - 179
	639.287	140 - 145.9	163	165 - 183
		146 - 152.9	169	171 - 183
		153 - 159	176	178 - 183
		158 - 164.9	181	183 - 204
		165 - 171.9	188	190 - 209
		172 - 178.9	195	197 - 209
		179 - 185	202	204 - 209

Accessories & Spare Parts

Insert Holders Short WC	Insert Holders Long WC	Inserts WC
		
► 501	► 501	► 470

Adjustment Instructions

- Mount the insert holders on mark «RSS/BALANCE»
- Set cutting edge 2 to the final bore diameter (ØD2)
- Set cutting edge 1 corresponding to the starting bore diameter, according to the table (column ØD1).

Insert Holders Chamfering for SW

These insert holders with step-less adjustable chamfer angle from 15° to 75° are made for front chamfering and, with limitations also for back chamfering, on the rough heads for roughing SW 41 to SW 148.

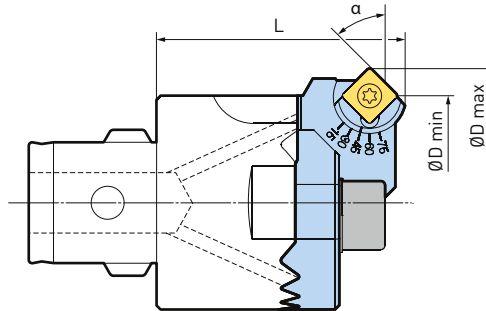

For Boring Head	Model	Order No.	Insert	Diameter Range ØD					L
				15° min - max	30° min - max	45° min - max	60° min - max	75° min - max	
SW41	IH1SW41CF	639.104	SC 09	33 - 60	36 - 62	39 - 63	43 - 63	45 - 62	51
SW53	IH1SW53CF	639.105		45 - 76	48 - 78	51 - 79	55 - 79	57 - 78	58
SW68	IH1SW68CF	639.106		61 - 97	64 - 99	67 - 100	71 - 100	73 - 99	68
SW98	IH1SW98CF	639.107	SC 12	77 - 126	81 - 128	86 - 129	90 - 128	94 - 127	73
	IH2SW98CF	639.108		104 - 153	108 - 155	113 - 156	117 - 155	121 - 154	
SW148	IH1SW148CF	639.109		131 - 180	135 - 182	140 - 183	144 - 182	148 - 181	73
	IH2SW148CF	639.110		158 - 207	162 - 209	167 - 210	171 - 209	175 - 208	
SW98	IH1SW98CF	639.107	SC 12	77 - 126	81 - 128	86 - 129	90 - 128	94 - 127	89 / 119
	IH2SW98CF	639.108		104 - 153	108 - 155	113 - 156	117 - 155	121 - 154	
SW148	IH1SW148CF	639.109		131 - 180	135 - 182	140 - 183	144 - 182	148 - 181	119
	IH2SW148CF	639.110		158 - 207	162 - 209	167 - 210	171 - 209	175 - 208	

B.1

1. Consisting of two insert holders, clamping screws and wrench.
2. The insert holders are also available by the piece as spare parts.
3. Insert holders must be set for balance cut.
4. L in chart indicates max. tool length with 45° chamfer angle.

Max. radial chamfer length for front and back chamfering

Applicable for inserts with nose radius 0.4 mm

For Boring Head		Chamfer Angle									
		15°		30°		45°		60°		75°	
		F1	F2	F1	F2	F1	F2	F1	F2	F1	F2
SW41	SC 09	7.7	0.7	6.9	1.4	5.7	1.8	4.0	1.7	2.1	1.2
SW53											
SW68											
SW98	SC 12	10.6	1.2	9.5	2.2	7.8	2.6	5.5	2.5	2.8	1.8
SW148											

Accessories & Spare Parts

<p>Insert holders for chamfering</p> <p>► 502</p>	<p>Blind Piece SW</p> <p>► 502</p>
---	------------------------------------

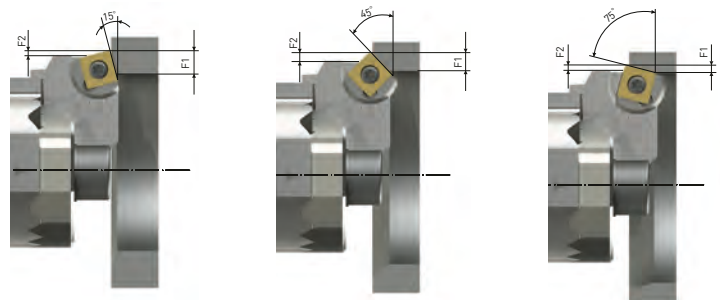

Insert Holders Back Boring for SW

These insert holders are made for back boring with the boring heads SW 32 to SW 148 and cover the diameter range from Ø 44 - 211 mm.

Insert holder with protection plate are available as set or as individual components.

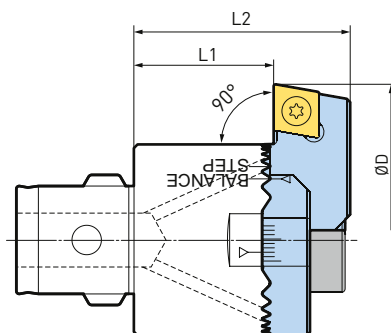

Model	Order No.	Head	ØD	ØD1	L1	L2	B	Insert
IH1SW32CBB	639.403	SW32	44 - 54	31	24	38	ØD-17 / min. 31	CC 09
IH1SW41CBB	639.404	SW41	53 - 66	39	29	44	ØD-21 / min. 39	CC 09
IH1SW53CBB	639.405	SW53	65 - 82	50	34	55	ØD-28 / min. 50	CC 12
IH1SW68CBB	639.406	SW68	81 - 103	63.5	41	66	ØD-27 / min. 63.5	CC 12
IH1SW98CBB	639.407	SW98	102 - 130	90	38 / 47 / 77	69 / 78 / 108	90	CC 12
IH2SW98CBB	639.408	SW98	129 - 157	90	38 / 47 / 77	69 / 78 / 108	90	CC 12
IH1SW148CBB	639.409	SW148	156 - 184	140	38 / 77	69 / 108	140	CC 12
IH2SW148CBB	639.410	SW148	183 - 211	140	38 / 77	69 / 108	140	CC 12

1. Consisting of two insert holders with back boring and protection piece.
2. The insert holders are also available by the piece as spare parts.
3. Insert holders must be set for balance cut.

B.1

Back boring

The back bore diameter «ØD» the diameter of the entry bore «C», the diameter of the interfering edge «B», respectively of the tool body «ØD1» are related to each other. In order to check the feasibility of the back boring operation and to select the best possible tool combination, these values can be calculated as follows:

Minimum entry bore diameter «C»:	$C = \frac{\text{ØD} + B}{2} + 0.5$
Max. diameter of the interfering edge «B»:	$B = 2 (C - 0.5) - \text{ØD}$
Clearance:	0.5 mm

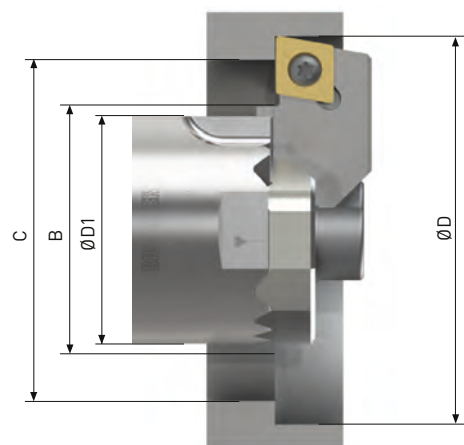

Accessories & Spare Parts

Insert Holders Back Boring for SW	Blind Piece SW	Inserts CC
		
► 502	► 502	► 475

Face Grooving Holders for SW Twin Cutter Set

Upgrade your existing rough boring heads SW: the face grooving holder provide the possibility to manufacture grooves in the diameter range from Ø 53 to 203 mm.

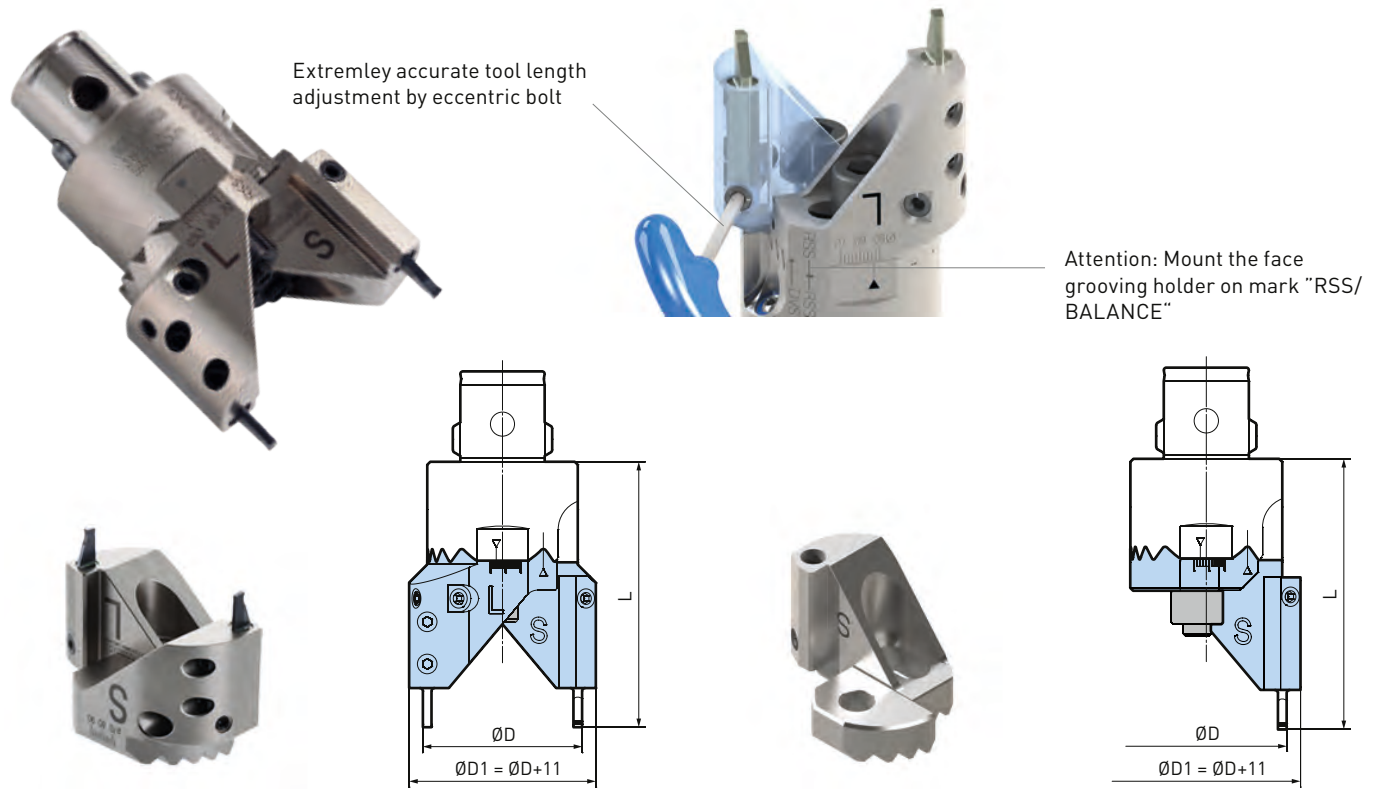

B.1

Twin Head Type

Model	Order No.	Head	ØD	L
IH1SW53FG	639.653	SW53	53 - 70	88
IH1SW68FG	639.663	SW68	68 - 90	95
IH1SW98FG	639.673	SW98	98 - 126	113
IH2SW68FG	639.667	SW68	88 - 110	95
IH2SW98FG	639.677	SW98	125 - 153	113
IH1SW148FG	639.683	SW148	148 - 176	143
IH2SW148FG	639.687	SW148	175 - 203	143

Single Head Type

Model	Order No.	Head	ØD	L
IH1SW53FGS	639.654	SW53	53 - 70	88
IH1SW68FGS	639.664	SW68	68 - 90	95
IH1SW98FGS	639.674	SW98	98 - 126	113
IH2SW68FGS	639.668	SW68	88 - 110	95
IH2SW98FGS	639.678	SW98	125 - 153	113
IH1SW148FGS	639.684	SW148	148 - 176	143
IH2SW148FGS	639.688	SW148	175 - 203	143

1. Inserts are to be ordered separately.
2. Consisting of two insert holders with different lengths, type S (short) and L (long).

Inserts for face grooves

For boring head SW 53 - 148, Series 318

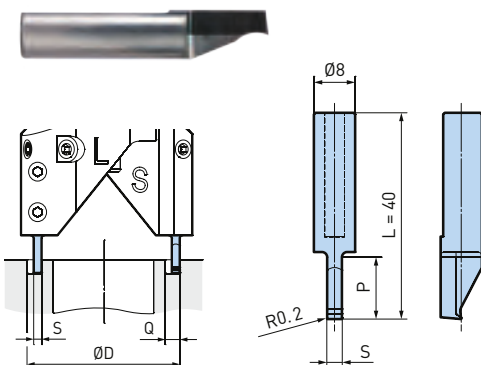

Model	Order No.	P	S	Q	Cutting material / coating
SS2-ST8-40K40	958.601	12	2	3.5	K40
SS2-ST8-40K40C	958.611	12	2	3.5	K40C
SS3-ST8-40K40	958.602	12	3	5.5	K40
SS3-ST8-40K40C	958.612	12	3	5.5	K40C
SS4-ST8-40K40	958.603	12	4	7.5	K40
SS4-ST8-40K40C	958.613	12	4	7.5	K40C
SS5-ST8-40K40	958.604	12	5	9.5	K40
SS5-ST8-40K40C	958.614	12	5	9.5	K40C

1. Insert consisting of one piece.

Guidelines

Insert Selection & Stock Allowance

BIG KAISER indexable inserts outlined in the Insert selection & cutting data tables have been selected to give optimum results. Grades and geometry do not have to be specified at time of order.

Insert radius is based upon 2 major factors:

1. Length/diameter ratio of tool
2. Depth of cut or material allowance
 - Select the largest nose radius available for cutting edge strength & higher feeds
 - Use small nose radius for light depth of cut & extreme L/D ratio

Insert Radius	Minimum D.O.C.	Maximum D.O.C.	L/D Ratio
0.2	0.25	1.5	>6:1
0.4	0.50	3.0	≤5:1
0.8	1.00	5.0	≤4:1
1.2	1.50	8.0	≤4:1

- D.O.C. is stock allowance/side (radius)

Feed

1. Feed: based on effective number of inserts, depending on roughing method

- Balanced cutting: 2 effective inserts
- Stepped cutting: 1 effective insert
- Full profile cutting: 1 effective insert

Insert Radius	Feed (mm/rev)	
	Balanced Cutting	Stepped Cutting
0.2	0.2 - 0.3	0.1 - 0.15
0.4	0.3 - 0.4	0.15 - 0.2
0.8	0.4 - 0.5	0.3 - 0.4

2. Under normal rough boring operations, the effective feed rate is about 50% of nose radius

General Rule:

Boring bar should always be smaller than original hole size.

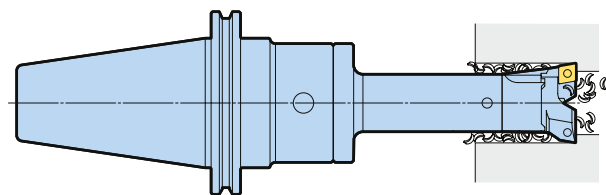

Caution

- It is very important to allow for clearance (F) between boring bar and rough bore diameter.

Troubleshooting

Under certain conditions, it may be necessary to modify or adapt recommended cutting data and/or tooling configurations of the application. Below are general solutions to common problems.

Problem	Possible Cause	Remedy
Poor Chip Control	Feed rate too low	Increase feed rate
	Width of chip excessive (D.O.C.)	Preset tool for stepped cutting method
	Excessive stock allowance	Consult cutting data tables
Chatter & Vibration	Excessive speed	Reduce Vc, check cutting data tables
	Extreme length/diameter ratio	Shorten tool to increase stiffness
		Increase boring bar diameter to larger size
		Change boring bar to carbide or heavy metal
	Insert radius too large	Reduce nose radius of insert
	Unstable workpiece	Improve fixture and clamping support
Lead angle on insert holders	Change to 90 degree insert holders (type CC)	
Inserts Chipping or Breaking	Wrong insert	Change to tougher grade of carbide insert Use larger radius if available
	Severe interruption	Increase speed, decrease feed
	Chips packing and re-cutting	Check for boring bar/bore diameter clearance
		Improve chip control, increase feed
Poor Tool Life	Wrong insert	Change to higher wear resistant grade
	Excessive cutting speed	Reduce speed
	Inserts chipping	Check stock allowance and feed rate
	Coolant pressure too low	Increase through tool coolant pressure
Adjust coolant ports of head if available		
Chips Not Evacuating	Boring bar diameter too large	Reduce to smaller head and extended range holder
	Excessive stock allowance	Re-set tool for stepped cutting
	Inadequate space below bore	Elevate workpiece from table more
	Poor chip control	See above problem
Insufficient Machine Power	Excessive feed rate	Reduce feed; minimum 25% of insert radius
	Stock allowance excessive	Reset tool for stepped cutting method
	Low machine torque	RPM in area of low spindle torque; increase speed
		RPM in area of gear change; adjust RPM
		Change insert to higher rake angle
Reduce depth of cut		
Excessive Exit Burr	Excessive feed rate	Reduce feed rate
	CC type insert holders	Use square insert holders with 6 degree lead
	Cutting forces too high	Reduce depth of cut
Reduce insert radius		

B.1

Fine Boring Heads with Centric Cutting Edge

Overview	396
EWE 2-152 Digital Fine Boring Head	398
EWN 2-152 Fine Boring Head	399
Accessories EWE / EWN 2-152	400
Tool Kits EWE / EWN 2-152	417
EWE 2-32 Digital Fine Boring Head	418
EWN 2-32 / 04-22 Fine Boring Head	419
Accessories EWE / EWN 2-32	420
Accessories EWN 04-22	426
EWN 04-15 Fine Boring Head	430
EWN 04-12 / 04-24 / 12-36 Fine Boring Heads	431
EWN 04-7 Fine Boring Head	433

B.2



EWE 2-152 Digital Fine Boring Head

Wireless communication for easy readout with the BIG KAISER app: The EWE fine boring head revolutionates fine boring process. Less operator mistakes, easier setup and a huge diameter range of \varnothing 2 - 152 mm. Also available as integral solution with HSK-A63. Accessories of EWN are fully compatible.
 \varnothing 2 - 152 mm, CK6/HSK-A63

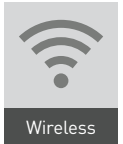

EWN 2-152 Fine Boring Head

Fine boring head with centric boring bars in modular and integral execution for accurate, high performance operations. The head comes with variable length adjustment of the boring bar and large dial disc for parallax-free readout.
 \varnothing 2 - 152 mm, CK6/DV40/HSK-A63/BIG CAPTO C6



EWE 2-32 Digital Fine Boring Head

Smallest digital fine boring head with wireless communication to the BIG KAISER app and centric boring bar. Especially manufactured for the use on small machine tools. Accessories of EWN are fully compatible.
 \varnothing 2 - 32 mm, CK5

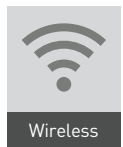

B.2



EWN 2-32 Fine Boring Head

Fine boring head with centric boring bar in integral, modular and screw-on execution for precise machining. Developed for the use on machine tools with spindles 30 taper, HSK-A50 and bigger, as well as on lathe machines with driven tools.
 \varnothing 2 - 32 mm, CK5/DV30/ES32



EWN 04-15 Fine Boring Head

Machining of small bores with high speeds on machine tools with spindles DV20, HSK-E32 and bigger.
 \varnothing 0.4 - 15 mm, CK3/ST16



EWN 04-7 Fine Boring Head

World's smallest fine boring head: Thanks to its body diameter of only \varnothing 18.5 mm, the EWN 04-7 is the perfect solution for micro machining applications.
 \varnothing 0.4 - 7 mm, CK1/ST6/ST10



B.2

BIG KAISER App

The new app simplifies the assembly and operation of rough and fine boring heads and provides extremely accurate cutting data. The various parameters can be saved in the app for later use, an important building block for workshops that want to get into smart manufacturing. The app currently supports 61 BIG KAISER fine and reaming heads with diameters from 0.4 mm - 620 mm.

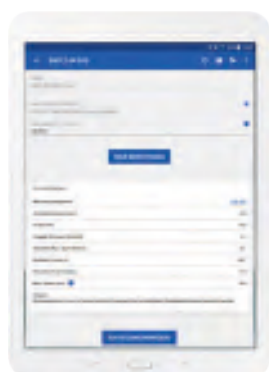

Cutting data



Send your data to...



History (made automatically)

This is how the app is going to support your daily challenges

1. Choose your tool
2. Type in your application values
3. Calculate cutting data
4. Adjust machine and make a measuring bore
5. Infeed tool with the diameter of the measuring bore
6. Make the bore middle tolerance

EWE 2-152 Digital Fine Boring Head, Ø 2 - 152

Digital fine boring head in modular and integral execution for accurate, high performance boring operations. With wireless communication to the BIG KAISER app.



CK6 Type

HSK-A63 Type

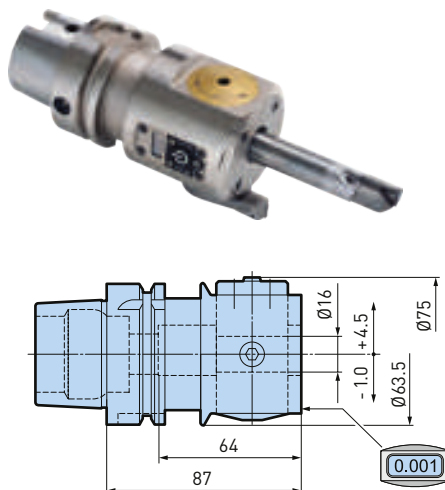
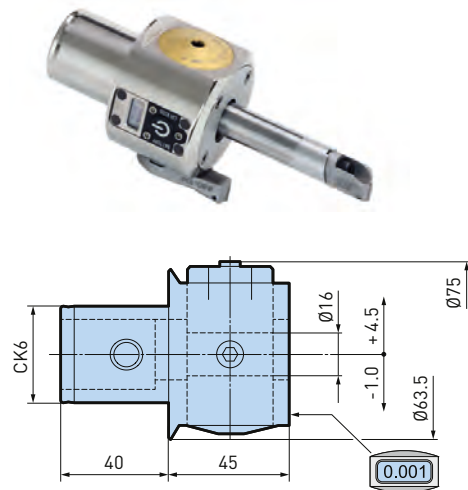

Model	Order No.
EWE2-152CK6	112.110

Model	Order No.
EWE2-152HSK-A63-87	112.126A



Quick Guide

B.2

EWE Reader

If no Smart Phone or BIG KAISER App is available, the digital Reader is the perfect alternative for making settings on the digital fine boring heads.



Model	Order No.	L	W	H
EWE Reader	719.000	90	44	15

1. Charger (micro USB cable) is not included.

EWN 2-152 Fine Boring Head, Ø 2 - 152

Fine boring heads in modular and integral execution for accurate, high performance boring operations on machine tools with spindles DV40, HSK-A63, BIG CAPTO C6 and bigger.

CK6 Type

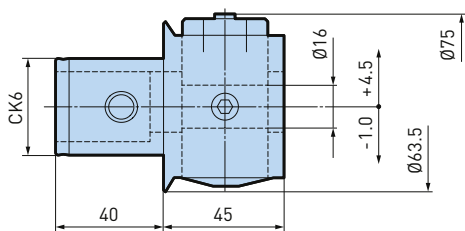

Model	Order No.
EWN2-152CK6	112.108

BIG CAPTO Type

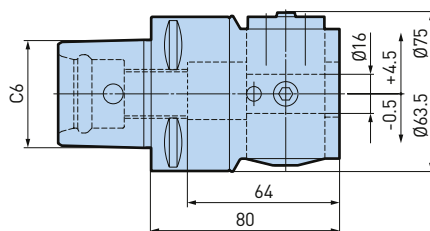

Model	Order No.
EWN2-152C6	470.108

EWB Type *

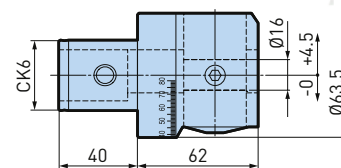

Model	Order No.
EWB2-50CK6	112.107

DV40 Type

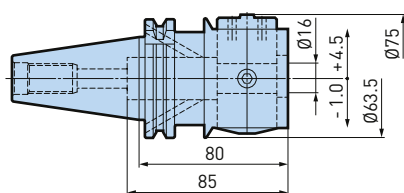

Model	Order No.
EWN2-152DV40	112.121

BR40 Type

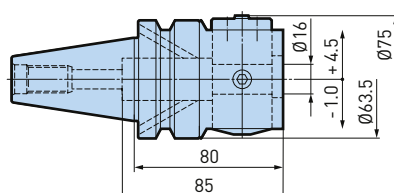

Model	Order No.
EWN2-152BT40	112.122

HSK-A63 Type

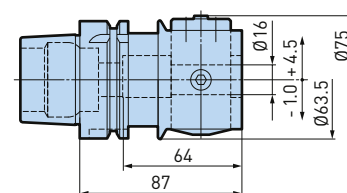

Model	Order No.
EWN2-152HSK-A63	112.123

1. * EWB Type has an integrated balancing mechanism. Ideal for high-speed machining.

Boring Head

Order No.

EWE2-152CK6

112.110

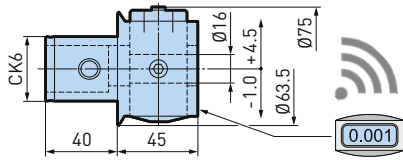

EWN2-152CK6

112.108

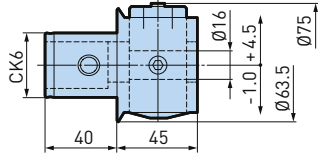

EWN2-152DV40

112.121

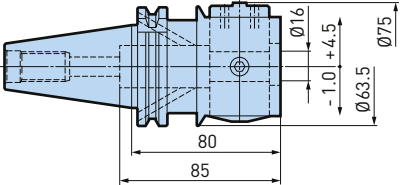

EWN2-152BT40

112.122

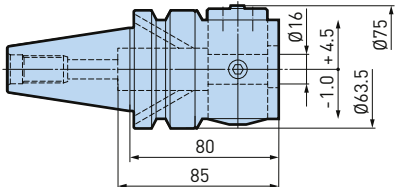

EWB2-50CK6

112.107

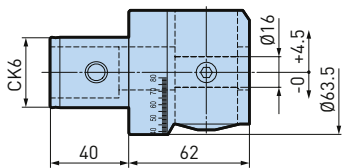

X = Boring depth

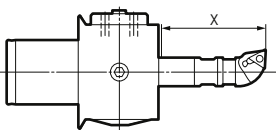



ØD

Boring range for the fine boring head EWN 2-152. Under full use of the adjustment range, the max. boring range will be,

- for EWN, EWE, EWB: Lower range + 9 mm Ø

 Carbide tool holders

 Recommended for EWB 2-50

RB16-4-100
613.424 

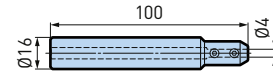

RB16-4
613.404

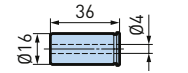

RB16-3.5-100
613.422 

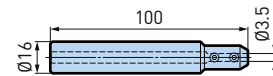

RB16-4.5-100
613.423 

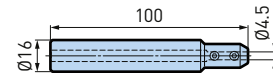

RB16-5-100
613.425 

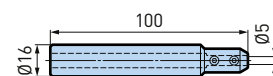

RB16-5
613.405

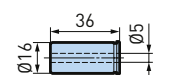

RB16-6-100
613.426 

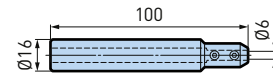

RB16-6
613.406

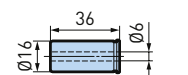

RB16-7-100
613.427 

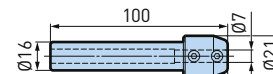

RB16-7
613.407

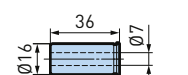

RB16-8-100
613.428 

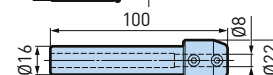

RB16-8
613.408

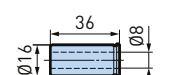

RB16-9-100
613.429 

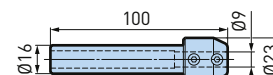

RB16-9
613.409

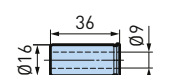

RB16-10-100
613.430 

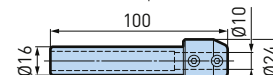

RB16-10
613.410

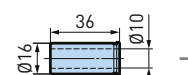

Fixed Tool Holder

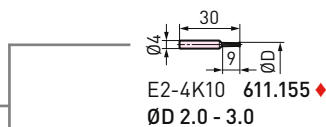

E2-4K10 611.155 ♦
ØD 2.0 - 3.0

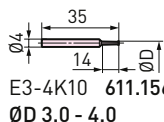

E3-4K10 611.156 ♦
ØD 3.0 - 4.0

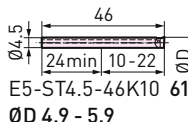

E5-ST4.5-46K10 615.081
ØD 4.9 - 5.9

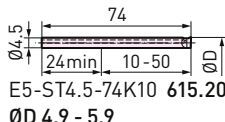

E5-ST4.5-74K10 615.204 ♦
ØD 4.9 - 5.9

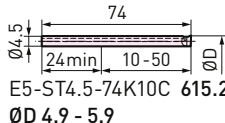

E5-ST4.5-74K10C 615.204A ♦
ØD 4.9 - 5.9

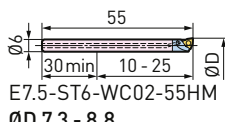

E7.5-ST6-WC02-55HM 615.084
ØD 7.3 - 8.8

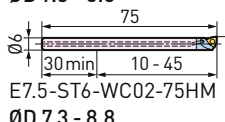

E7.5-ST6-WC02-75HM 615.085
ØD 7.3 - 8.8

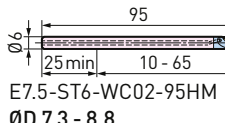

E7.5-ST6-WC02-95HM 615.202 ♦
ØD 7.3 - 8.8

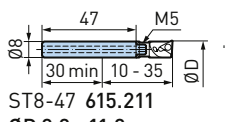

ST8-47 615.211
ØD 8.8 - 11.8

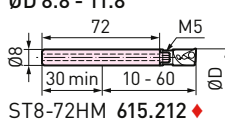

ST8-72HM 615.212 ♦
ØD 8.8 - 11.8

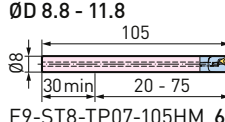

E9-ST8-TP07-105HM 615.213 ♦
ØD 8.8 - 11.8

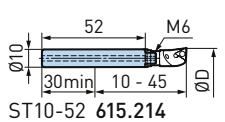

ST10-52 615.214
ØD 11.8 - 13.8

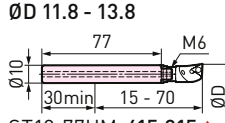

ST10-77HM 615.215 ♦
ØD 11.8 - 13.8

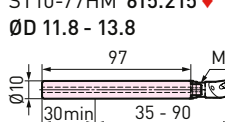

ST10-97HM 615.223 ♦
ØD 11.8 - 13.8

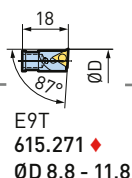

E9T 615.271 ♦
ØD 8.8 - 11.8

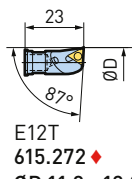

E12T 615.272 ♦
ØD 11.8 - 13.8

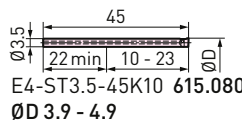

E4-ST3.5-45K10 615.080
ØD 3.9 - 4.9

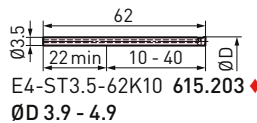

E4-ST3.5-62K10 615.203 ♦
ØD 3.9 - 4.9

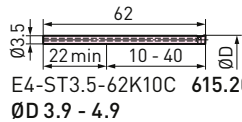

E4-ST3.5-62K10C 615.203A ♦
ØD 3.9 - 4.9

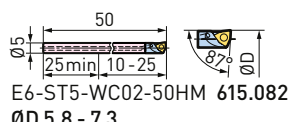

E6-ST5-WC02-50HM 615.082
ØD 5.8 - 7.3

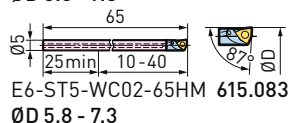

E6-ST5-WC02-65HM 615.083
ØD 5.8 - 7.3

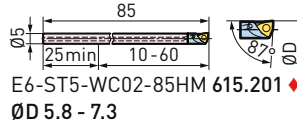

E6-ST5-WC02-85HM 615.201 ♦
ØD 5.8 - 7.3

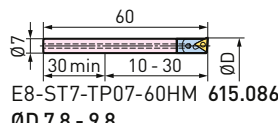

E8-ST7-TP07-60HM 615.086
ØD 7.8 - 9.8

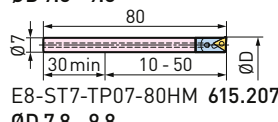

E8-ST7-TP07-80HM 615.207 ♦
ØD 7.8 - 9.8

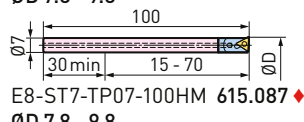

E8-ST7-TP07-100HM 615.087 ♦
ØD 7.8 - 9.8

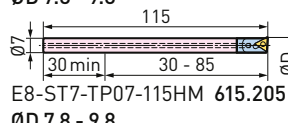

E8-ST7-TP07-115HM 615.205
ØD 7.8 - 9.8

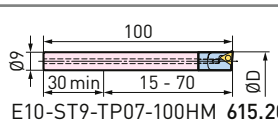

E10-ST9-TP07-100HM 615.208 ♦
ØD 9.8 - 11.8

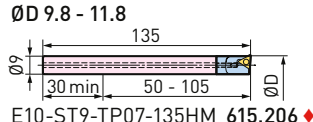

E10-ST9-TP07-135HM 615.206 ♦
ØD 9.8 - 11.8



Boring Head

Order No.

EWE2-152CK6

112.110

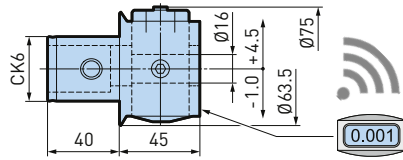

EWN2-152CK6

112.108

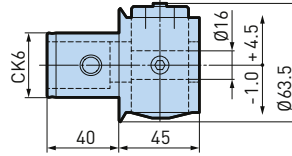

EWN2-152DV40

112.121

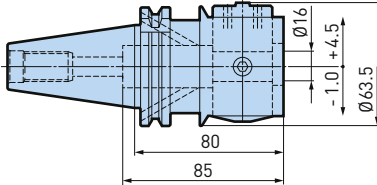

EWN2-152BT40

112.122

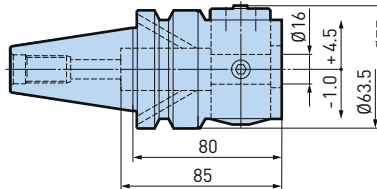

EWB2-50CK6

112.107

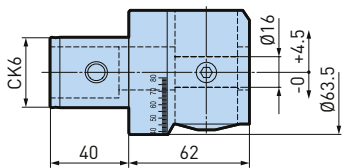

RB16-9
613.409

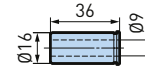

RB16-11
613.411

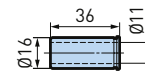

RB16-13
613.413

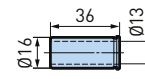

B.2

X = Boring depth

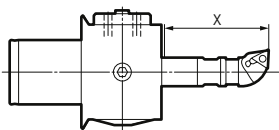

ØD

Boring range for the fine boring head EWN 2-152.
Under full use of the adjustment range, the max. boring range will be,

- for EWN, EWE, EWB: Lower range + 9 mm Ø

 Carbide tool holders

Adjustable Tool Holder

The adjustable tool holder allows the coarse diameter setting on the insert holder. This leads to the possibility to machine bores from $\varnothing 9.8 - 54$ mm with the tool holder in the centre position and as a result, with the best possible balancing of the tool combination.

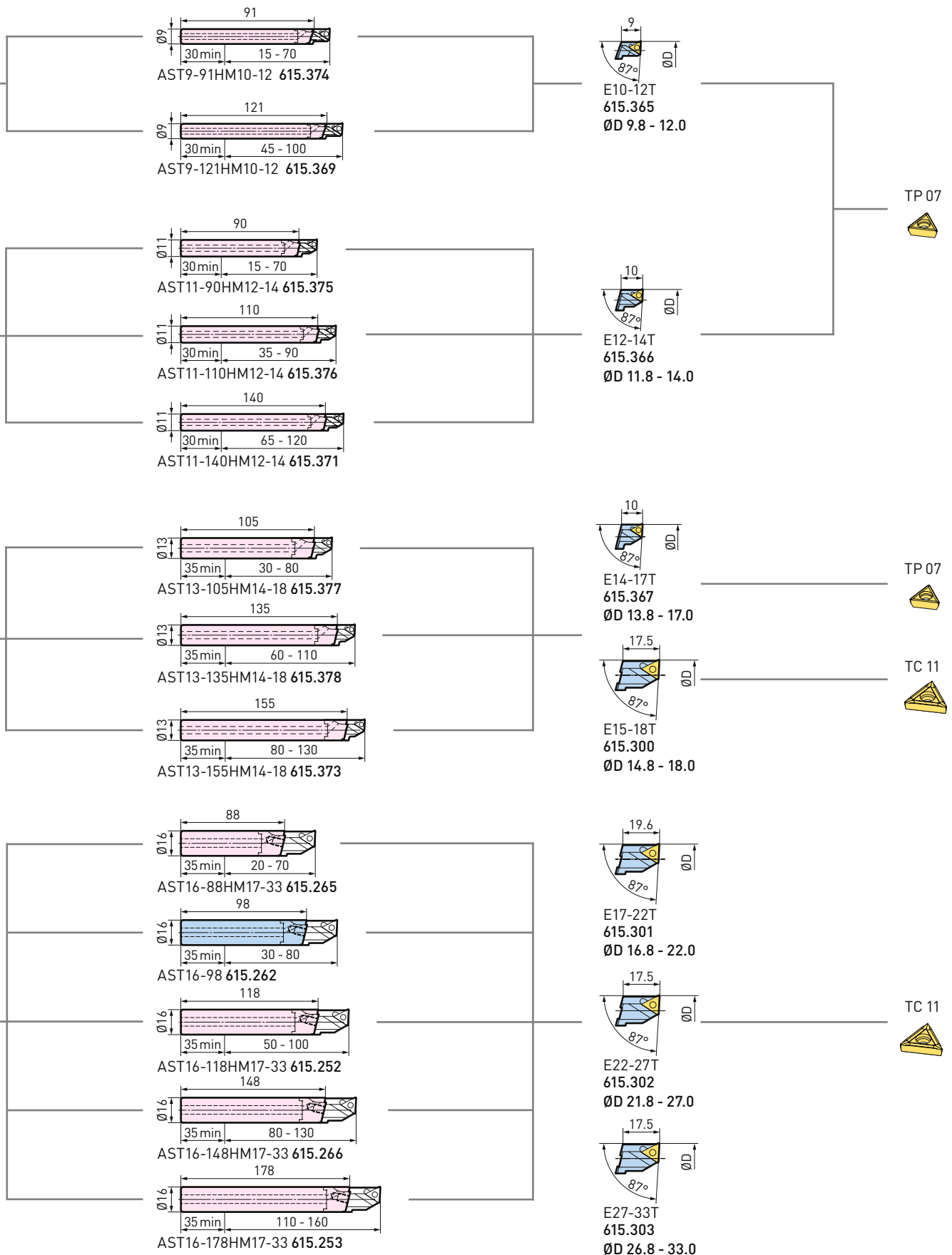

Boring Head

Order No.

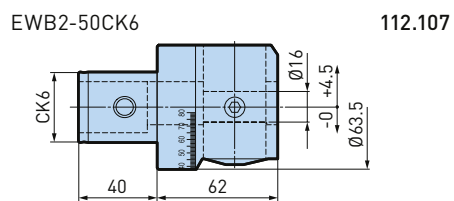
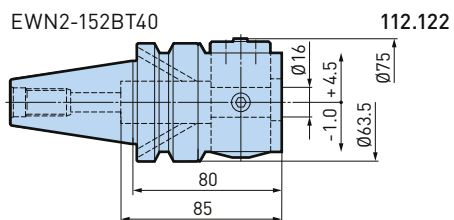
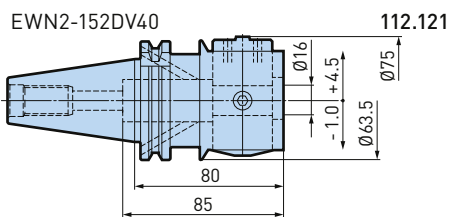
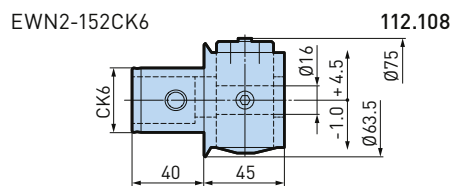
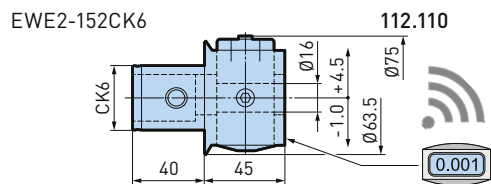

X = Boring depth

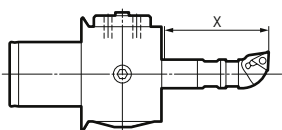

ØD

Boring range for the fine boring head EWN 2-152.
Under full use of the adjustment range, the max. boring range will be,

- for EWN, EWE, EWB: Lower range + 9 mm Ø

 Carbide tool holders

♦ Recommended for EWB 2-50

RB16-11
613.411 ♦

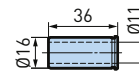

RB16-12
613.412 ♦

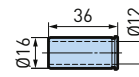

RB16-13
613.413 ♦

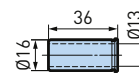

RB16-14
613.414 ♦

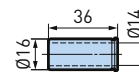

Fixed Tool Holder

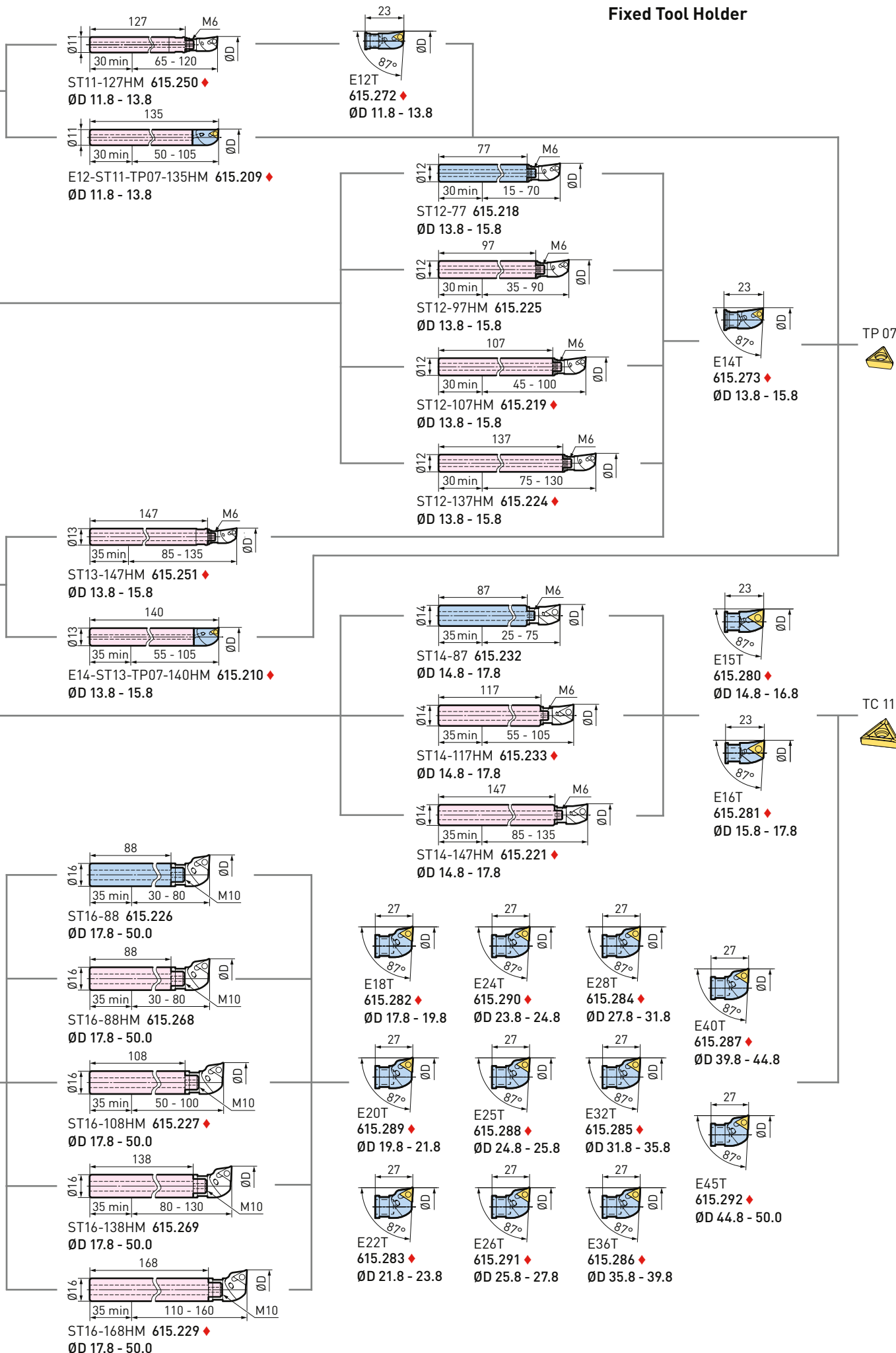

B.2

Boring Head

Order No.

EWE2-152HSK-A63

112.126A

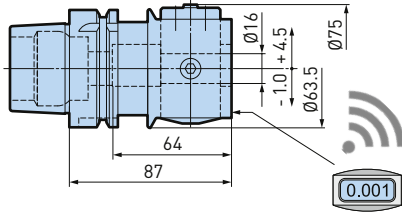

EWN2-152HSK-A63

112.123

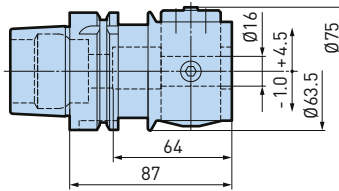

EWN2-152C6

470.108

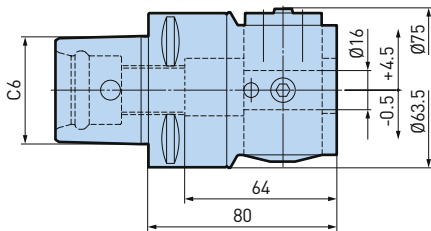

X = Boring depth

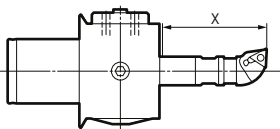

ØD

Boring range for the fine boring head EWN 2-152.
Under full use of the adjustment range, the max. boring range will be,

- for EWN, EWE, EWB: Lower range + 9 mm Ø

 Carbide tool holders

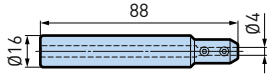
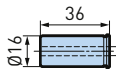
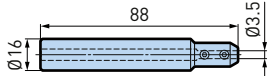
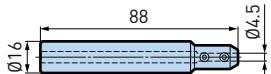
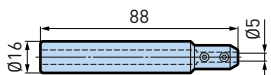
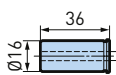
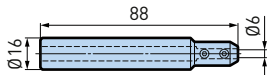
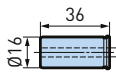
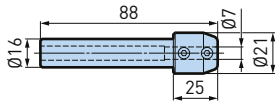
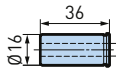
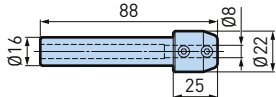
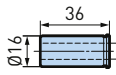
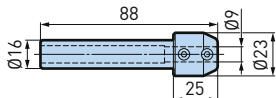
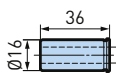
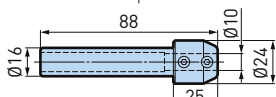
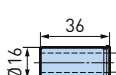
RB16-4-88 613.434	
RB16-4 613.404	
RB16-3.5-88 613.432	
RB16-4.5-88 613.433	
RB16-5-88 613.435	
RB16-5 613.405	
RB16-6-88 613.436	
RB16-6 613.406	
RB16-7-88 613.437	
RB16-7 613.407	
RB16-8-88 613.438	
RB16-8 613.408	
RB16-9-88 613.439	
RB16-9 613.409	
RB16-10-88 613.440	
RB16-10 613.410	

Fixed Tool Holder

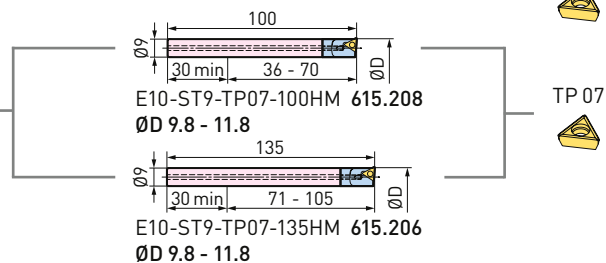
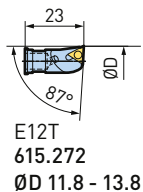
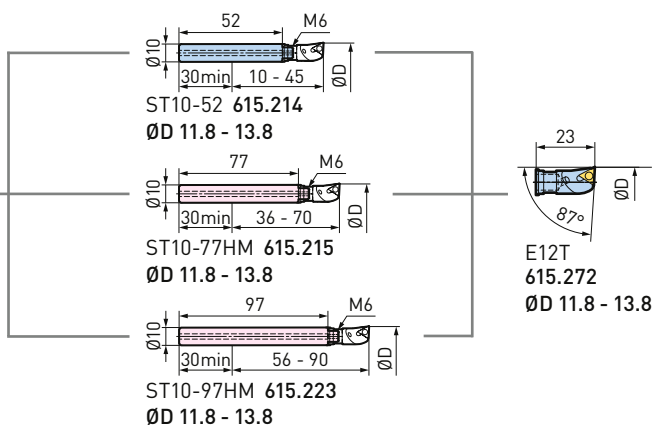
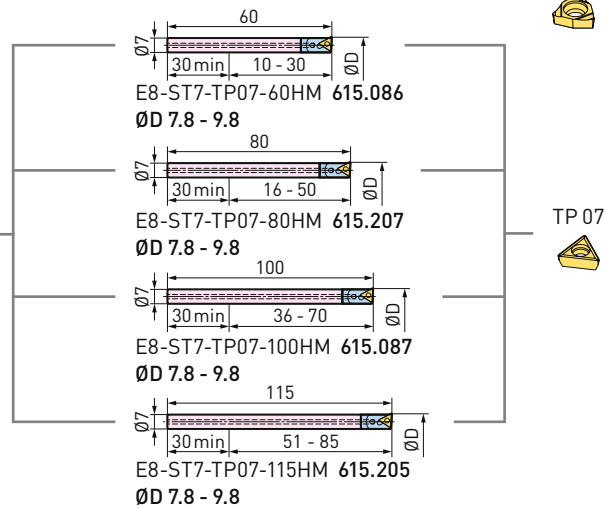
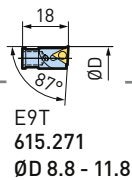
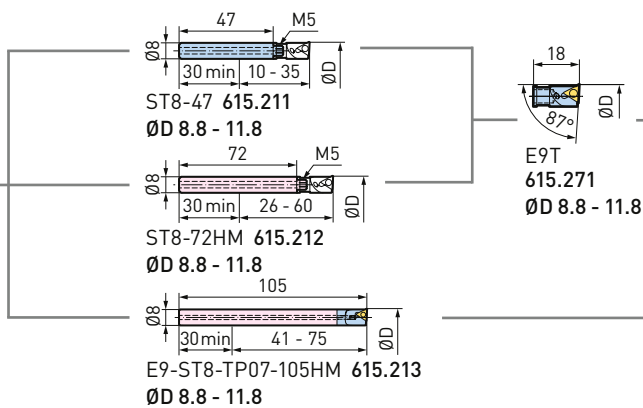
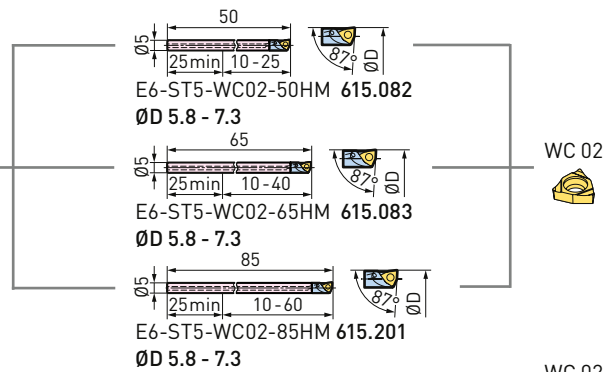
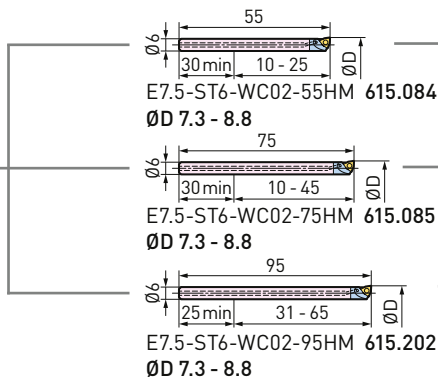
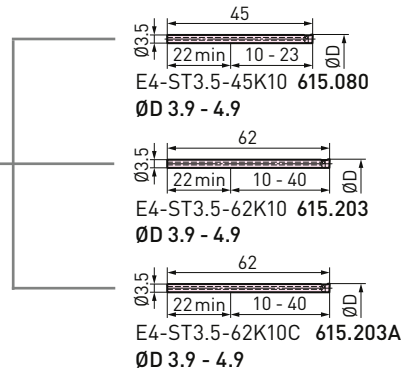
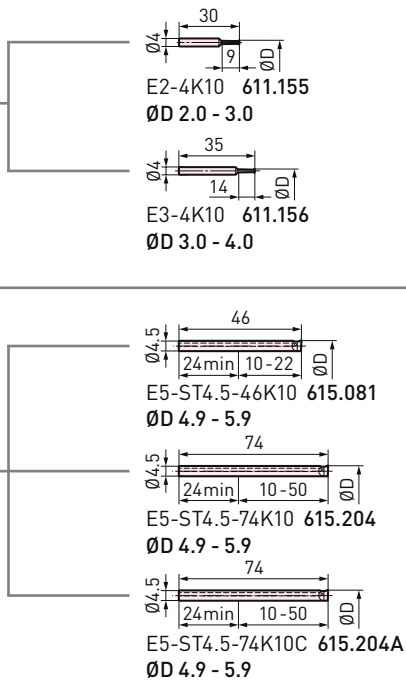

Boring Head

Order No.

EWE2-152HSK-A63

112.126A

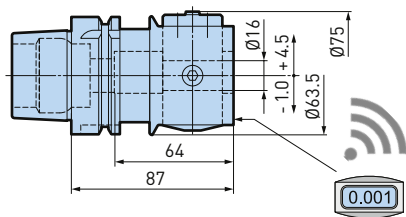

EWN2-152HSK-A63

112.123

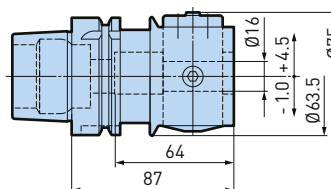

EWN2-152C6

470.108

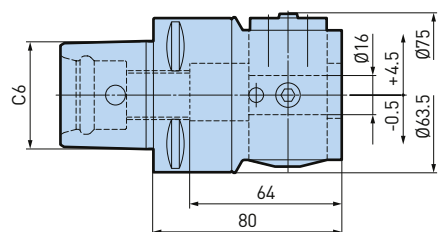

RB16-9
613.409

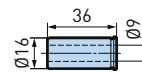

RB16-11
613.411

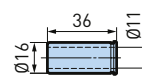

RB16-13
613.413

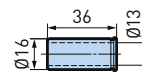

B.2

X = Boring depth

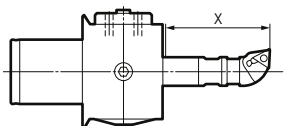

ØD

Boring range for the fine boring head EWN 2-152.
Under full use of the adjustment range, the max. boring range will be,

- for EWN, EWE, EWB: Lower range + 9 mm Ø

 Carbide tool holders

Adjustable Tool Holder

The adjustable tool holder allows the coarse diameter setting on the insert holder. This leads to the possibility to machine bores from $\varnothing 9.8 - 54$ mm with the tool holder in the centre position and as a result, with the best possible balancing of the tool combination.

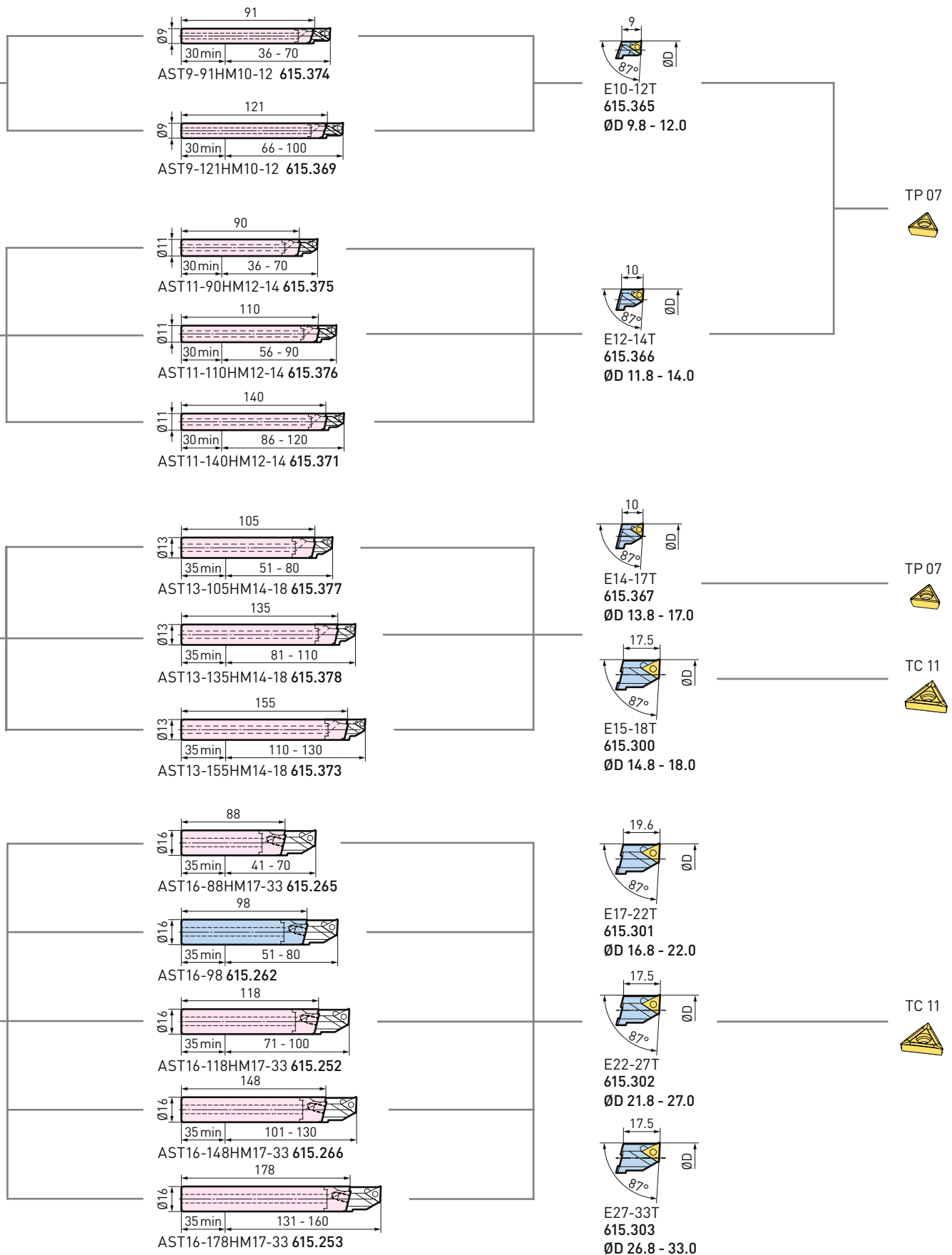

Boring Head

Order No.

EWE2-152HSK-A63

112.126A

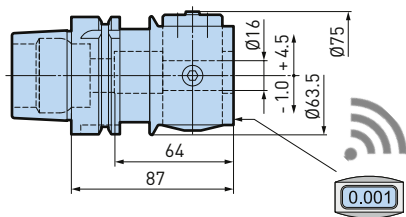

RB16-11
613.411

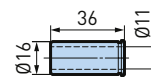

EWN2-152HSK-A63

112.123

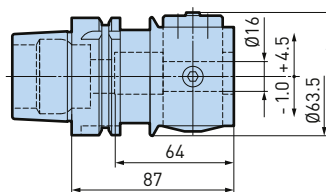

RB16-12
613.412

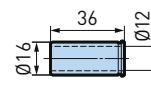

EWN2-152C6

470.108

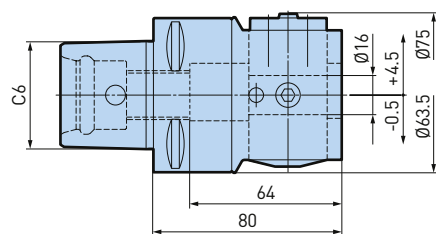

RB16-13
613.413

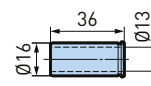

RB16-14
613.414

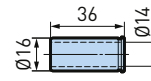

B.2

X = Boring depth

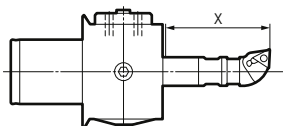

ØD

Boring range for the fine boring head EWN 2-152.
Under full use of the adjustment range, the max. boring range will be,

- for EWN, EWE, EWB: Lower range + 9 mm Ø

 Carbide tool holders

Fixed Tool Holder

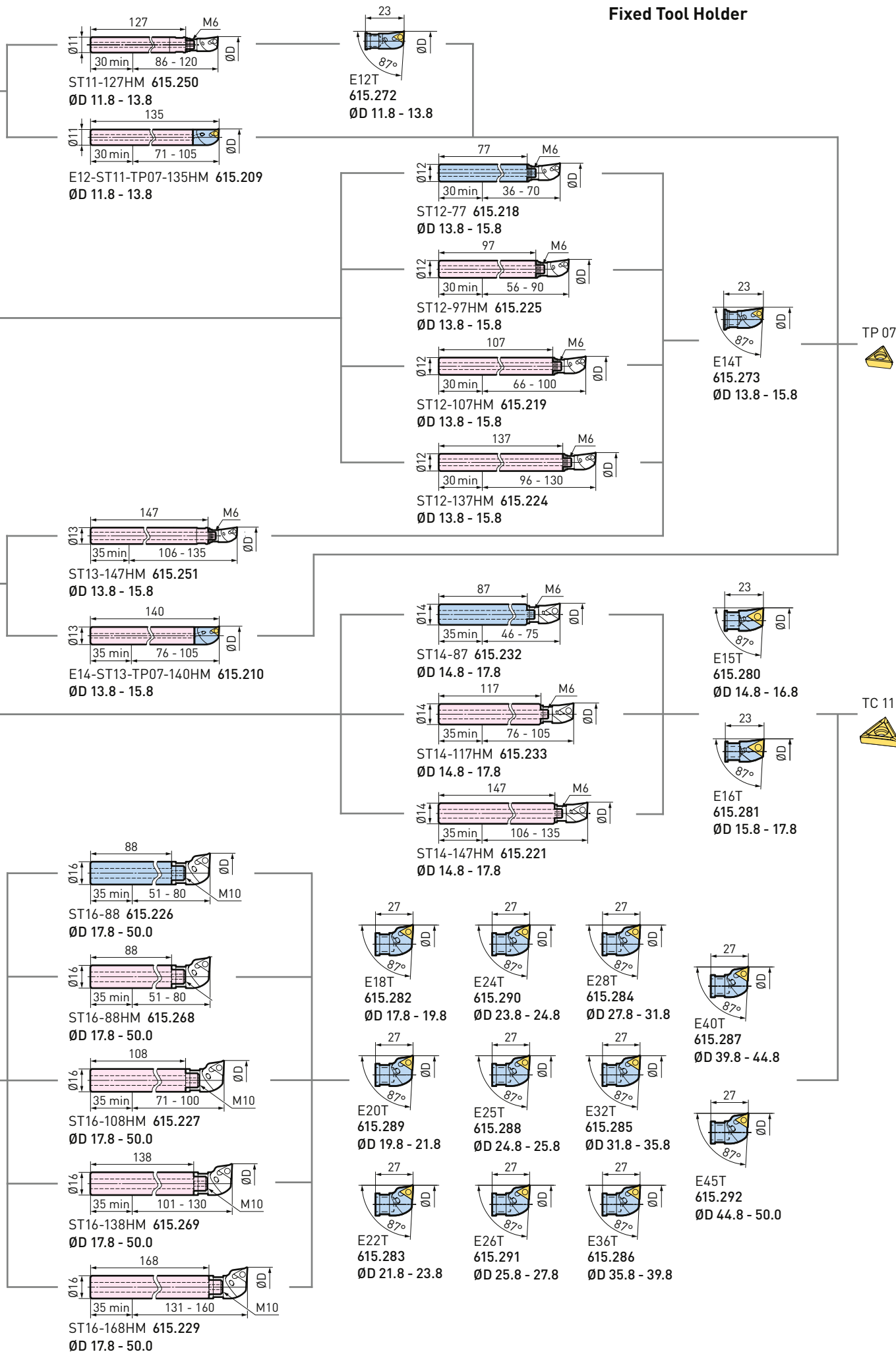

B.2

Adjustable Tool Holders

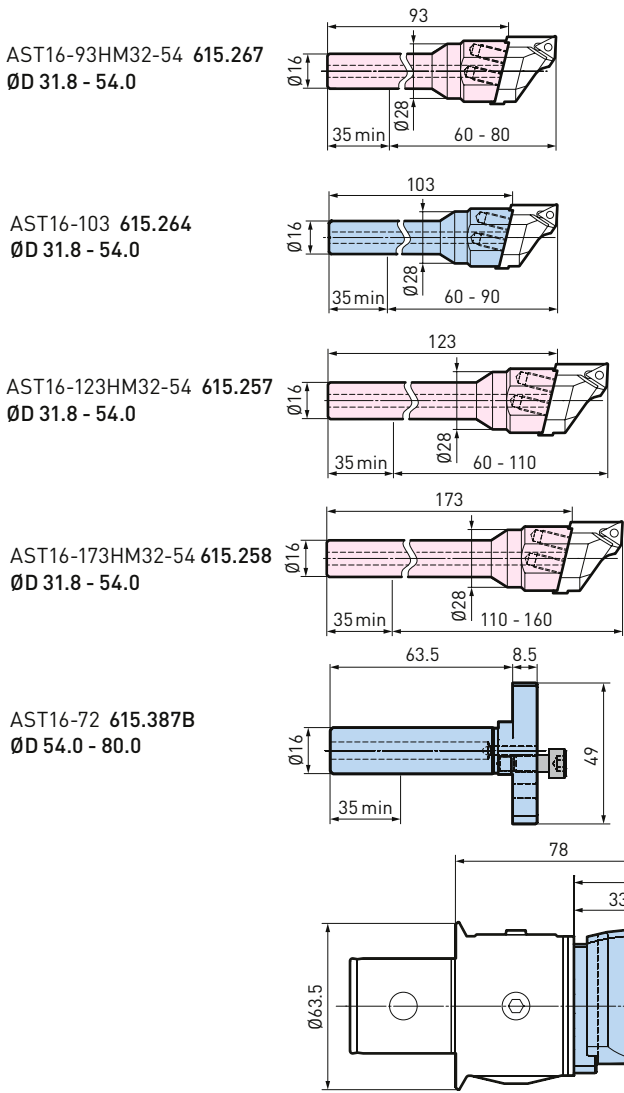

Adjustable insert holder

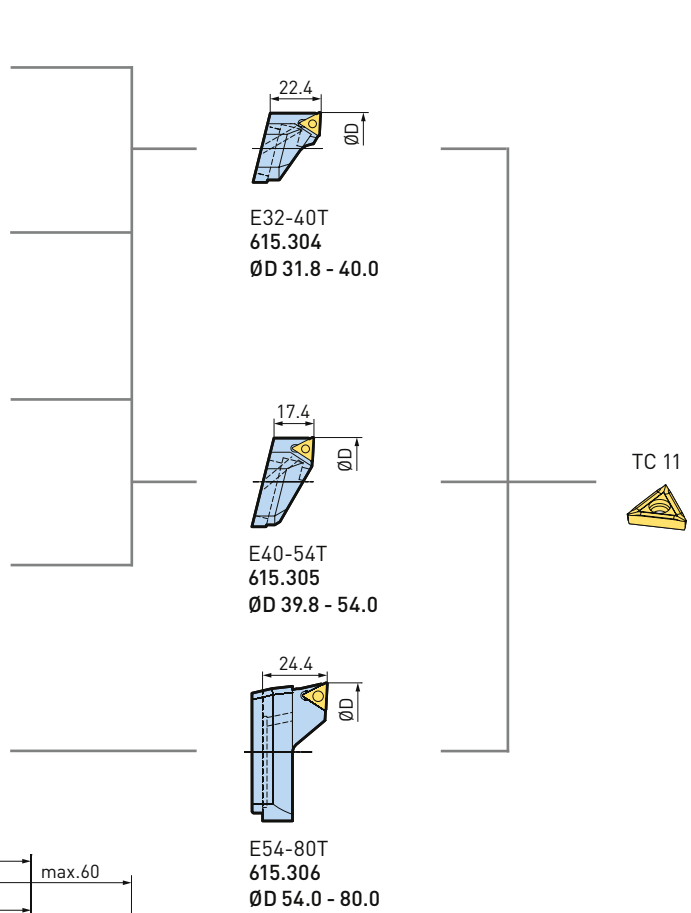

B.2

Screw On Insert Holder CC06

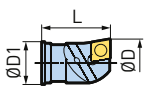

Model	Order No.	ØD	ØD1	L	Insert
E12C	615.420	11.8 - 14.5	10	23	CC 06
E14C	615.421	13.8 - 16.5	12	23	CC 06
E16C	615.422	15.8 - 18.5	14	23	CC 06

Screw On Insert Holder CC09

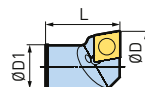

Model	Order No.	ØD	ØD1	L	Insert
E18C	615.423	17.8 - 20.5	16	27	CC 09
E20C	615.424	19.8 - 22.5	16	27	CC 09
E22C	615.425	21.8 - 24.5	16	27	CC 09
E24C	615.426	23.8 - 25.5	16	27	CC 09
E26C	615.427	25.8 - 28.5	16	27	CC 09
E28C	615.428	27.8 - 32.5	16	27	CC 09
E30C	615.429	29.8 - 34.5	16	27	CC 09

Chamfering Rings

Chamfering rings for tool holders made of steel and carbide Ø 12 and Ø 16 mm, for 45° chamfering right after boring, without tool change.

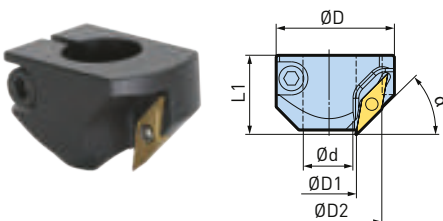

Model	Order No.	Ød	ØD	ØD1	ØD2	L1	α	Insert
CR13-27ST12V	615.394	12	35	12.6	27.7	24	45°	VC 11
CR17-31ST16V	615.395	16	39.5	16.6	31.7	24	45°	VC 11

Back Boring Holders

Insert holder for back boring

ST10-52 615.214
ØD 15.8 - 20.5

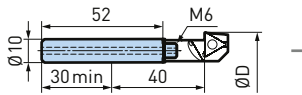

ST10-77HM 615.215
ØD 15.8 - 20.5

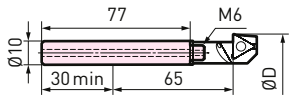

ST10-97HM 615.223
ØD 15.8 - 20.5

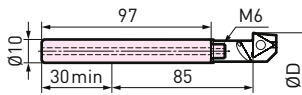

ST12-77 615.218
ØD 19.8 - 25.8

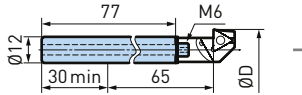

ST12-107HM 615.219
ØD 19.8 - 25.8

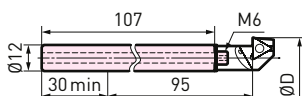

ST12-137HM 615.224
ØD 19.8 - 25.8

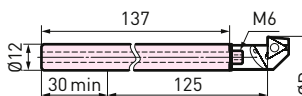

ST14-87 615.232
ØD 25.8 - 28.8

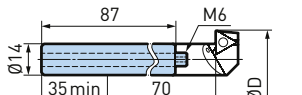

ST14-117HM 615.233
ØD 25.8 - 28.8

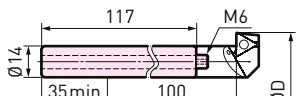

ST14-147HM 615.221
ØD 25.8 - 28.8

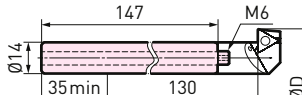

ST16-88 615.226
ØD 28.8 - 44.5

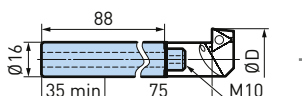

ST16-108HM 615.227
ØD 28.8 - 44.5

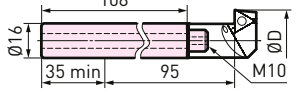

ST16-168HM 615.229
ØD 28.8 - 44.5

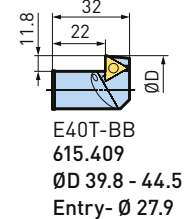
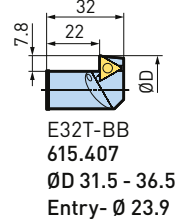
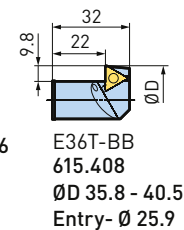
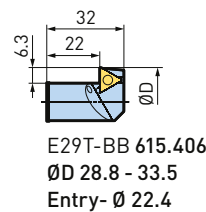
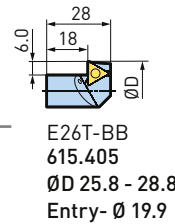
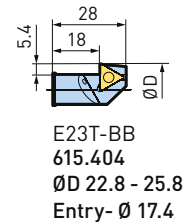
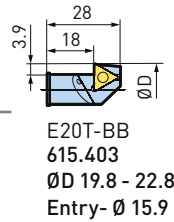
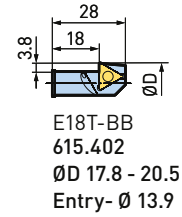
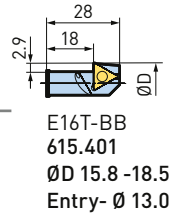
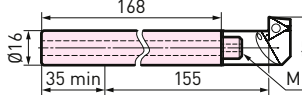

TC 11



B.2

Reduction for Boring Bars

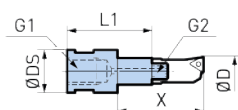

Model	Order No.	ØD	ØDs	L1	X	G1	G2
ST16-10-32	615.230	11.8 - 14.5	16	32	36	M10	M6
ST16-12-32	615.231	13.8 - 18.5	16	32	36	M10	M6

Extensions for Boring Bars

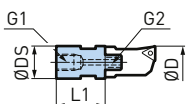

Model	Order No.	ØD	ØDs	L1	G1	G2
ST12-18	615.220	13.8 - 16.5	12	18	M6	M6
ST16-25	615.228	17.8 - 50	16	25	M10	M10

Periferical Insert Holders for EWN/EWE, Ø 80 - 152

EWN2-152CK6

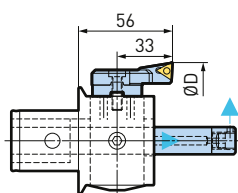

EWN2-152DV40

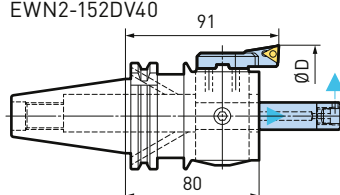

EWN2-152BT40

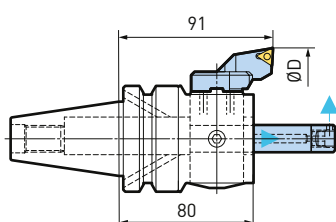

EWN2-152HSK-A63

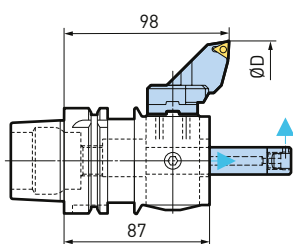

B.2

	Parts	Model	Order No.	Insert	Front Bore ØD	Back Bore ØD
	Insert Holder	EK80-104T	626.908	TC 11	80 - 92	-
	Spacer	DD30-6	626.907		92 - 104	92 - 104
	Insert Holder	EK80-104T	626.908		104 - 116	104 - 116
	Spacer	DD30-6	626.907		116 - 128	116 - 128
	Insert Holder	EK104-128T	626.909		128 - 140	128 - 140
	Spacer	DD30-6	626.907		140 - 152	140 - 152
	Insert Holder	EK128-152T	626.910			
	Tool Holder	ST16-88	615.226			
	Coolant Nozzle	CN2-50	615.392			

1. Tool holder must be used when using periferical insert holder.
2. Coolant Nozzle is always recommended to use with Tool Holder.

Balancing Rings

The balancing rings are mounted on the boring heads. The imbalance has to be measured on a balancing machine. The correction of the imbalance is done by moving the scale rings.

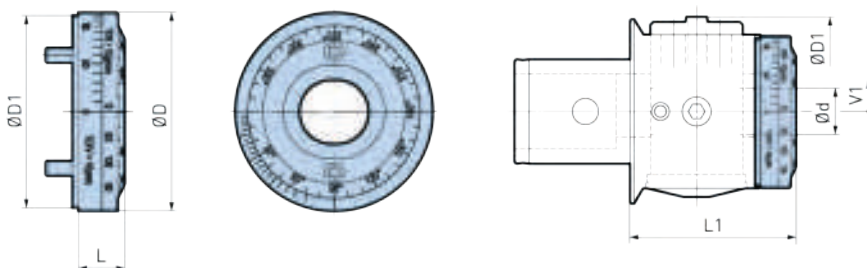

Model	Order No.	Ød	ØD	ØD1	L	L1	V1
BR2-152	112.806	16	53	51	13	58	1

1. The Front plate of EWE and EWN must be removed.

Insert Holder Face Grooving, Ø 14 - 54

Tool holder, insert holder, and grooving insert are made for face grooving with the fine boring head EWN/EWE 2-152.

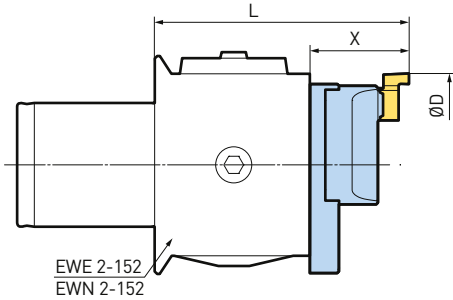

Adjustable Tool Holder Face Grooving, Ø 14 - 54

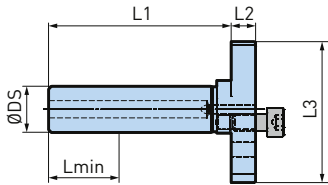

Model	Order No.	ØD	ØDs	L	L1	L2	L3	L min	X
AST16-72	615.387B	14 - 53	16	77 - 104	63.5	8.5	49	35	32

B.2

Insert Holder Face Grooving, Ø 14 - 54

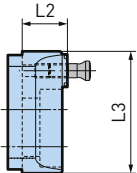

Model	Order No.	L2	L3
FGH14-54	615.388	13	34.5

Inserts for face grooves, Ø 14 - 54

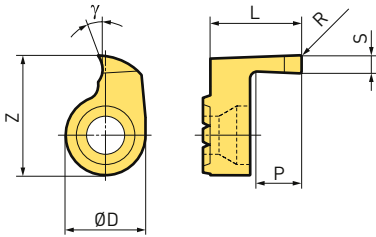

Model	Order No.	ØD	L	P	S	Z	R	Rake Angle γ
RD1420P30C	958.501	9	10.3	5	2	13.5	0.2	20°
RD1425P30C	958.502	9	10.3	5	2.5	13.5	0.2	20°
RD1430P30C	958.503	9	10.3	5	3	13.5	0.2	20°

1. Insert consisting of one piece.

OD Turning Holders for EWN/EWE, Ø 1 - 32

By using an eccentric bar on the fine boring heads EWN/EWE 2-152, it is possible to turn outside diameters up to 32 mm with lengths up to 50 mm. The counterweight is moveable on the eccentric bar. By moving the counterweight, the imbalance can be compensated to a minimum.

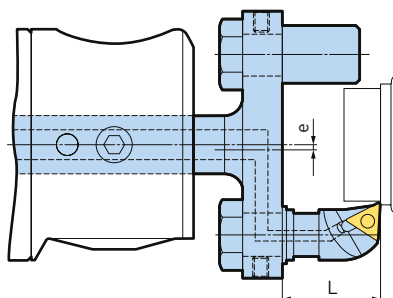

Max. Spindle Speeds		
e [mm]	L = 27 [min ⁻¹]	L = 52 [min ⁻¹]
0	7 000	5 500
0.5	5 000	4 500
2.5	4 000	3 500
4.5	3 000	2 500

Attention: Counter-clockwise rotation of spindle!

Remark:

Adjustment of the scale in clockwise direction and eccentric bar with cutting edge positioned as shown on the drawing, results in a smaller pin diameter.

B.2

OD Turning Holders, Ø 1 - 32

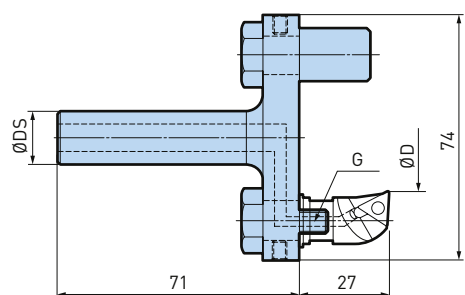

Model	Order No.	ØD	ØDs	G
ST16-OD-32	615.390	1 - 32	16	M10

Extension

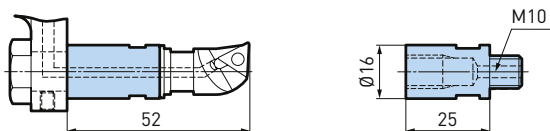

Model	Order No.
ST16-25	615.228

Insert Holders

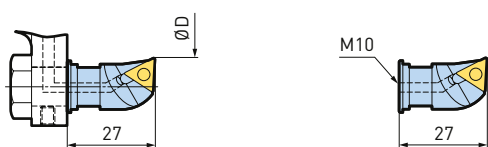

Model	Order No.	ØD	Insert
E18T	615.282	28 - 32	TC 11
E22T	615.283	24 - 28	
E26T	615.291	20 - 24	
E32T	615.285	15 - 20	
E36T	615.286	11 - 15	
E40T	615.287	6 - 11	
E45T	615.292	1 - 6	

Tool Kit EWN/EWE 2-152, Ø 17.8 - 152

The tool kit EWN 2-152 and EWE 2-152, Ø 17.8 - 152 mm, is available in different versions.
The versions differ in the length and the material of the boring bars and in the number of the inserts.

Model	Order No.
EWN2-152-18-152SET-A	112.837A

Model	Order No.	Qty.
EWN2-152CK6	112.108	1
ST16-88	615.226	1
AST16-72	615.387B	1
E18T	615.282	1
E25T	615.288	1
E32T	615.285	1
E40T	615.287	1
E45T	615.292	1
E54-80T	615.306	1

Model	Order No.	Qty.
DD30-6	626.907	1
EK80-104T	626.908	1
EK104-128T	626.909	1
EK128-152T	626.910	1
TCGT-110204FL-FM10C	655.389	2
ETL-M6x20A-DIN6912	690.156	2
ETL-GRS-TORX-PLUS-T7-IP	694.807	1
CN2-50	615.392	1

Model	Order No.
EWN2-152-18-152SET-B	112.837B

Model	Order No.	Qty.
EWN2-152CK6	112.108	1
ST16-108HM	615.227	1
AST16-72	615.387B	1
E18T	615.282	1
E25T	615.288	1
E32T	615.285	1
E40T	615.287	1
E45T	615.292	1
E54-80T	615.306	1

Model	Order No.	Qty.
DD30-6	626.907	1
EK80-104T	626.908	1
EK104-128T	626.909	1
EK128-152T	626.910	1
TCGT-110204FL-FM10C	655.389	10
ETL-M6x20A-DIN6912	690.156	2
ETL-GRS-TORX-PLUS-T7-IP	694.807	1
CN2-50	615.392	1

Model	Order No.
EWN2-152-18-152SET-C	112.837C

Model	Order No.	Qty.
EWN2-152CK6	112.108	1
ST16-108HM	615.227	1
AST16-72	615.387B	1
E18T	615.282	1
E25T	615.288	1
E32T	615.285	1
E40T	615.287	1
E45T	615.292	1
E54-80T	615.306	1

Model	Order No.	Qty.
DD30-6	626.907	1
EK80-104T	626.908	1
EK104-128T	626.909	1
EK128-152T	626.910	1
TCGT-110204FL-FM10C	655.389	2
ETL-M6x20A-DIN6912	690.156	2
ETL-GRS-TORX-PLUS-T7-IP	694.807	1
CN2-50	615.392	1

Model	Order No.
EWE2-152-18-152SET-E	112.837E



Model	Order No.	Qty.
EWE2-152CK6	112.11	1
ST16-108HM	615.227	1
AST16-72	615.387B	1
E18T	615.282	1
E25T	615.288	1
E32T	615.285	1
E40T	615.287	1
E45T	615.292	1
E54-80T	615.306	1

Model	Order No.	Qty.
DD30-6	626.907	1
EK80-104T	626.908	1
EK104-128T	626.909	1
EK128-152T	626.910	1
TCGT-110204FL-FM20C	655.318	2
ETL-M6x20A-DIN6912	690.156	2
ETL-GRS-TORX-PLUS-T7-IP	694.807	1
CN2-50	615.392	1

Tool Kit EWN/EWE 2-152, Ø 16.8 - 33

Model	Order No.
EWN2-152-17-33SET-A	112.097A

Model	Order No.	Qty.
EWN2-152CK6	112.108	1
AST16-118HM17-33	615.252	1
E17-22T	615.301	1
E22-27T	615.302	1

Model	Order No.	Qty.
E27-33T	615.303	1
ETL-ST5-SW6	690.806	1
TCGT-110204FL-FK10C	655.383	10

Model	Order No.
EWE2-152-17-33SET-C	112.097C

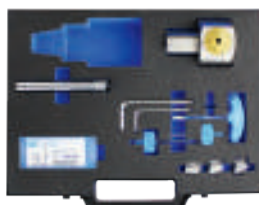

Model	Order No.	Qty.
EWE2-152CK6	112.110	1
AST16-118HM17-33	615.252	1
E17-22T	615.301	1
E22-27T	615.302	1

Model	Order No.	Qty.
E27-33T	615.303	1
ETL-ST5-SW6	690.806	1
TCGT-110204FL-FK10C	655.383	10

1. All tool kit EWN2-152/EWE2-152 are delivered in an exclusive case.
2. EWE2-152 are digital version of EWN2-152.

EWE 2-32 Digital Fine Boring Head, Ø 2 - 32

The EWE 2-32 is the smallest digital fine boring head with centre insert holder. It is especially suitable for use on small machines.

CK5 Type

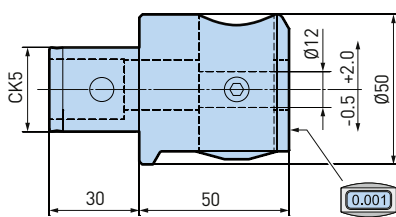

Model	Order No.
EWE2-32CK5	112.310

EWB 2-32 Fine Boring Head, Ø 2 - 32

The EWB2-32CK5 has an integrated balance mechanism. Ideal for high-speed machining.

CK5 Type

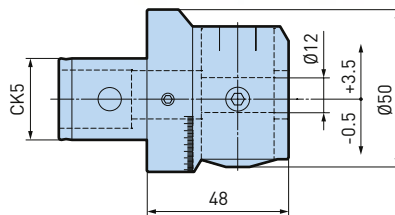

Model	Order No.
EWB2-32CK5	112.306



Wireless

B.2

BIG KAISER App

The new app simplifies the assembly and operation of rough and fine boring heads and provides extremely accurate cutting data. The various parameters can be saved in the app for later use, an important building block for workshops that want to get into smart manufacturing. The app currently supports 61 BIG KAISER fine and reaming heads with diameters from 0.4 mm - 620 mm.

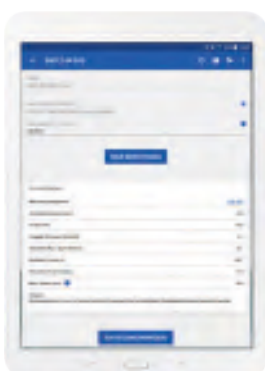

Cutting data



Send your data to...



History (made automatically)

This is how the app is going to support your daily challenges

1. Choose your tool
2. Type in your application values
3. Calculate cutting data
4. Adjust machine and make a measuring bore
5. Infeed tool with the diameter of the measuring bore
6. Make the bore middle tolerance

EWN 2-32 Fine Boring Head, Ø 2 - 32

Fine boring head in integral, modular, and screw-on execution for the precise machining of bores.

CK5 Type

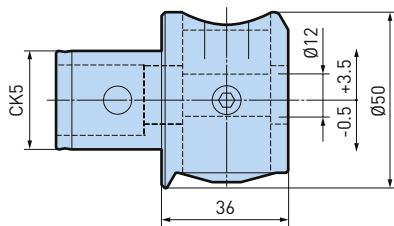

Model	Order No.
EWN2-32CK5	112.301A

DV30 Type

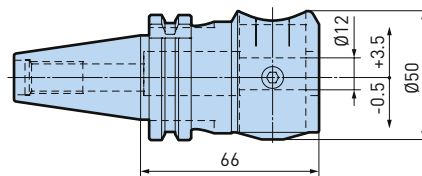

Model	Order No.
EWN2-32DV30	112.303A

ER32 Type

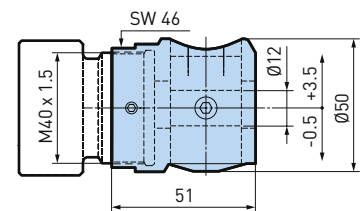

Model	Order No.
EWN2-32ES32	112.304A

B.2

EWN 04-22 Fine Boring Head, Ø 0.4 - 22

CK4 Type

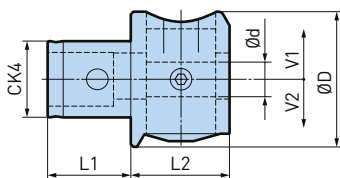

Model	Order No.
EWN04-22CK4	112.206

HSK-E40 Type

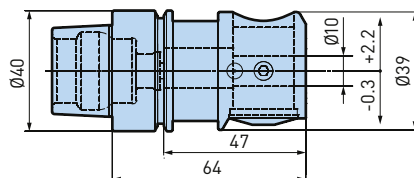

Model	Order No.
EWN04-22HSK-E40-64	112.207

ER25 Type

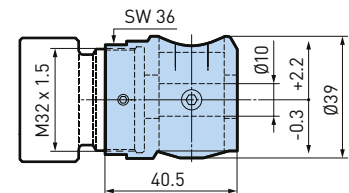

Model	Order No.
EWN04-22ES25	112.205

Boring Head

Order No.

EWE2-32CK5

112.310

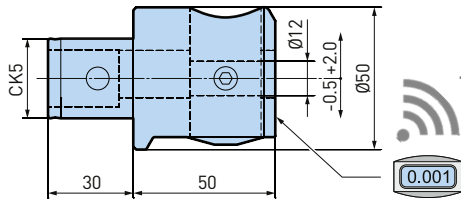

EWN2-32CK5

112.301A

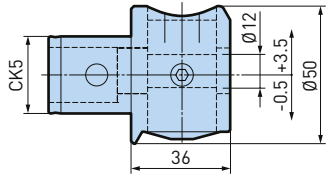

EWB2-32CK5

112.306

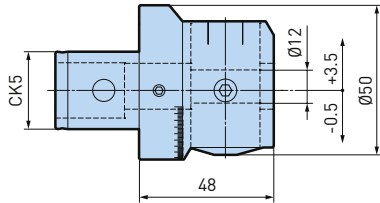

EWN2-32DV30

112.303A

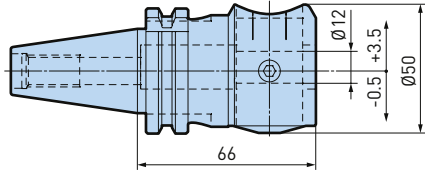

EWN2-32ES32

112.304A

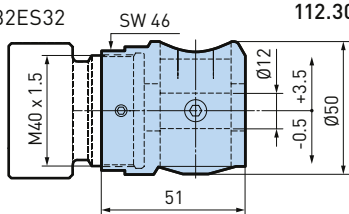

Reduction Sleeve for ER

Model	Order No.	A1
TB-ES32-ES25	112.353	M32 x 1.5
TB-ES32-ES16	112.385	M22 x 1.5

ØD

Boring range for the fine boring head EWN 2-32.
Under full use of the adjustment range, the max boring range will be,

- for EWN/EWB 2-32: Lower range + 7 mm Ø
- for EWE 2-32: Lower range + 4 mm Ø

 Carbide tool holders

♦ Recommended for EWB 2-32

RB12-4-85
613.324

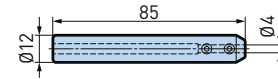

RB12-4
613.304 ♦

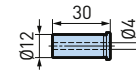

RB12-3.5-85
613.323 ♦

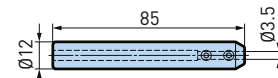

RB12-4.5-85
613.326 ♦

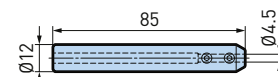

RB12-5-85
613.325 ♦

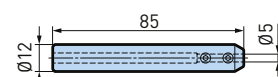

RB12-5
613.305 ♦

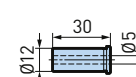

RB12-6-85
613.327 ♦

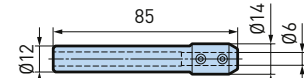

RB12-6
613.306 ♦

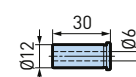

RB12-7
613.307 ♦

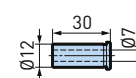

RB12-8
613.308 ♦

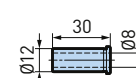

Fixed Tool Holder

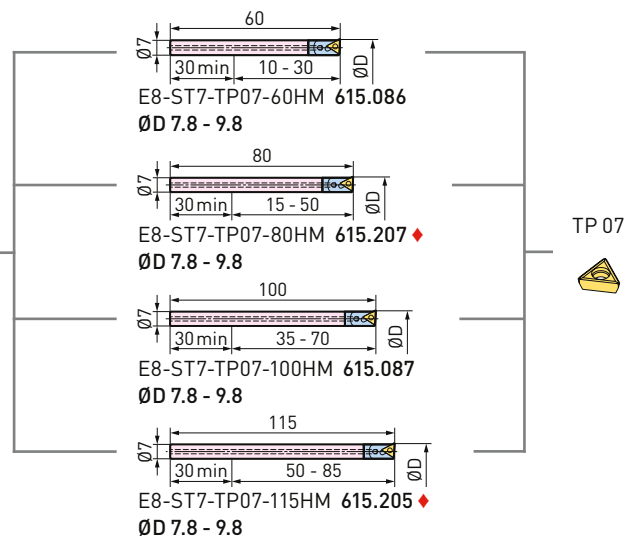
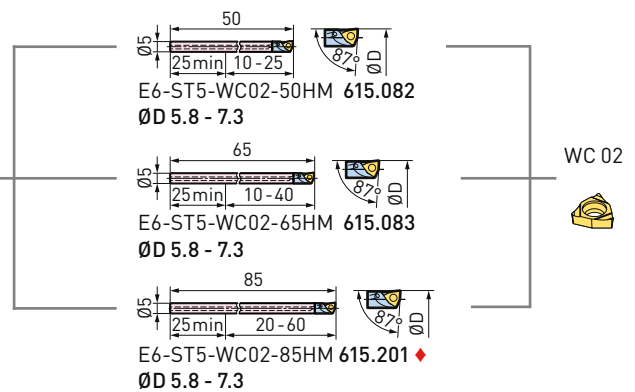
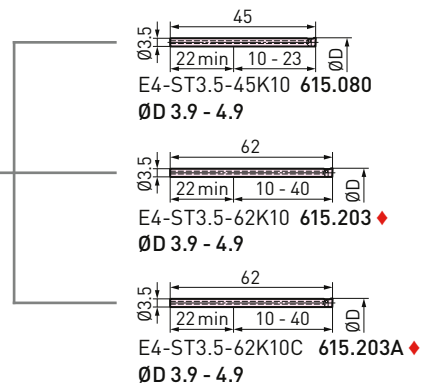
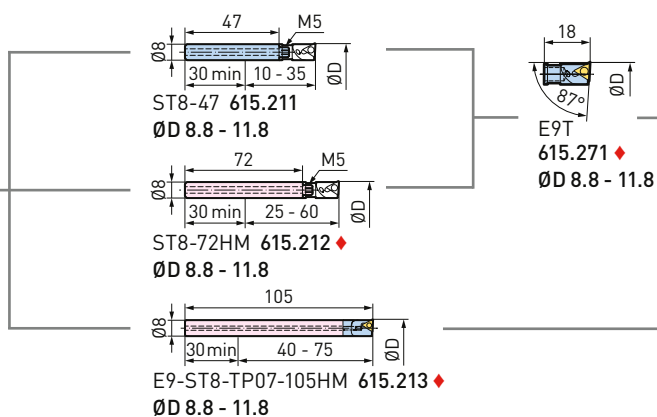
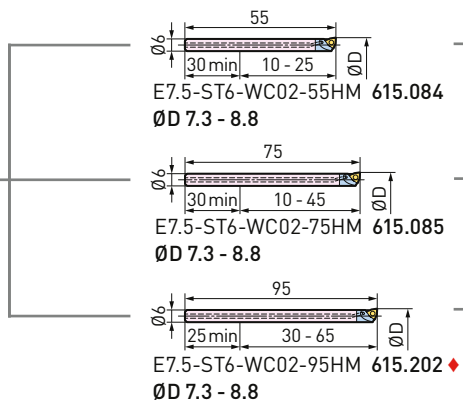
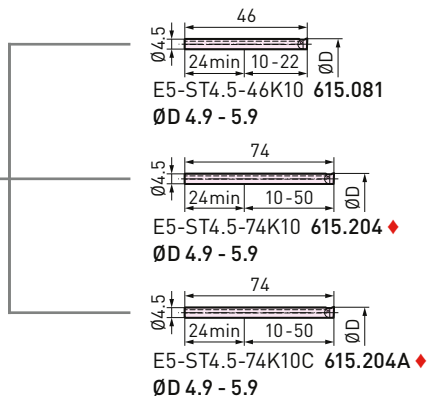
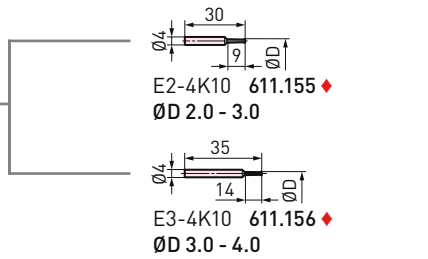

WC 02

WC 02

TP 07

TP 07

B.2

Boring Head

Order No.

EWE2-32CK5

112.310

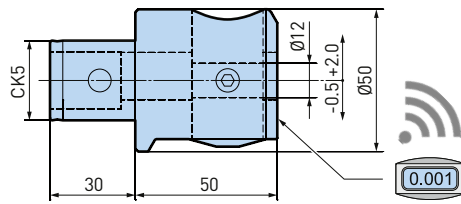

EWN2-32CK5

112.301A

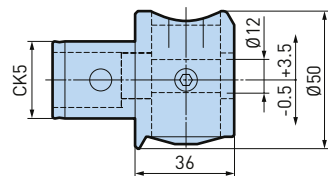

EWB2-32CK5

112.306

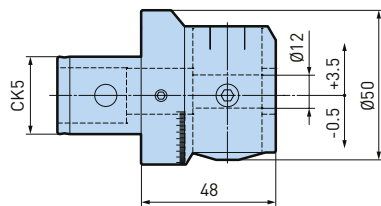

EWN2-32DV30

112.303A

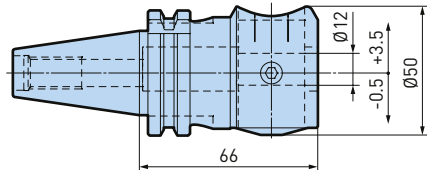

EWN2-32ES32

112.304A

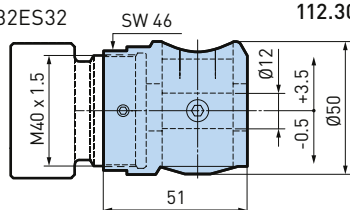

RB12-9
613.309

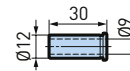

RB12-10
613.310

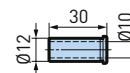

B.2

Reduction Sleeve for ER

Model	Order No.	A1
TB-ES32-ES25	112.353	M32 x 1.5
TB-ES32-ES16	112.385	M22 x 1.5

ØD

Boring range for the fine boring head EWN 2-32.
Under full use of the adjustment range, the max boring range will be,

- for EWN/EWB 2-32: Lower range + 7 mm Ø
- for EWE 2-32: Lower range + 4 mm Ø



Carbide tool holders

Adjustable Tool Holder

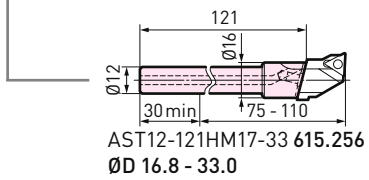
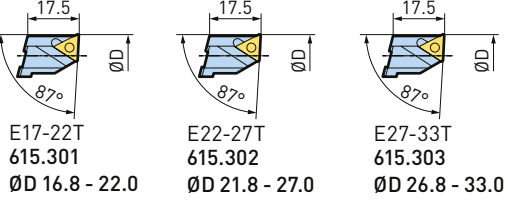
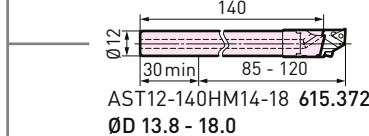
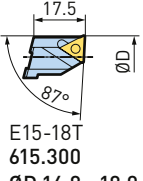
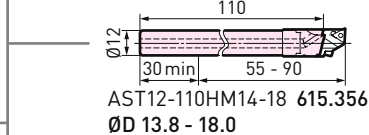
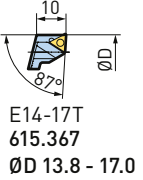
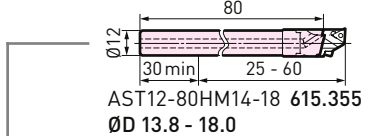
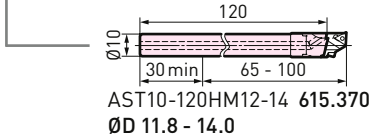
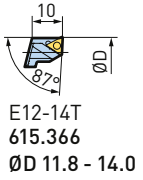
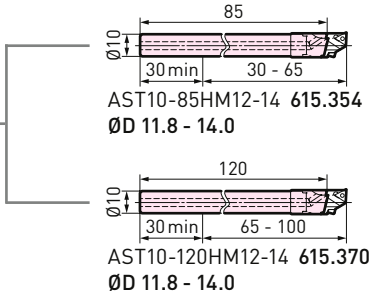
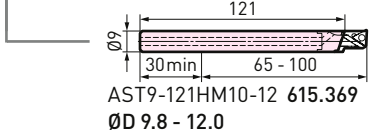
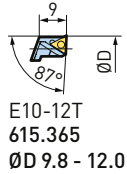
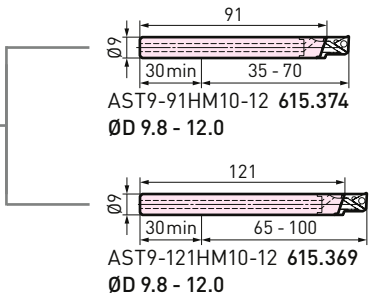

TP 07



B.2

TC 11



Boring Head

Order No.

EWE2-32CK5

112.310

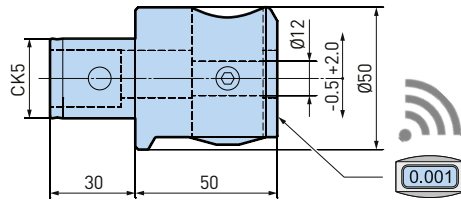

RB12-9
613.309

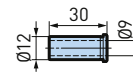

EWN2-32CK5

112.301A

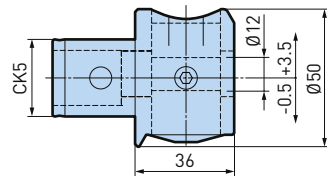

RB12-10
613.310

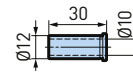

EWB2-32CK5

112.306

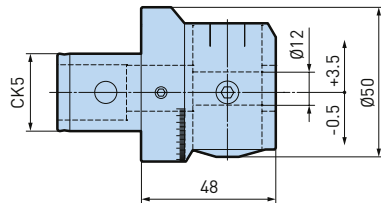

EWN2-32DV30

112.303A

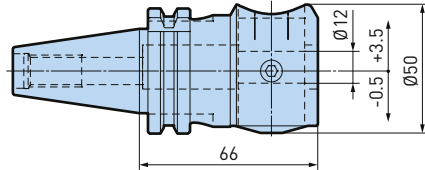

EWN2-32ES32

112.304A

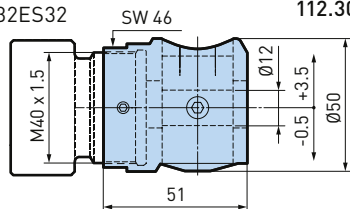

B.2

Reduction Sleeve for ER

Model	Order No.	A1
TB-ES32-ES25	112.353	M32 x 1.5
TB-ES32-ES16	112.385	M22 x 1.5

ØD

Boring range for the fine boring head EWN 2-32.
Under full use of the adjustment range, the max boring range will be,

- for EWN/EWB 2-32: Lower range + 7 mm Ø
- for EWE 2-32: Lower range + 4 mm Ø

 Carbide tool holders

 Recommended for EWB 2-32

Fixed Tool Holder

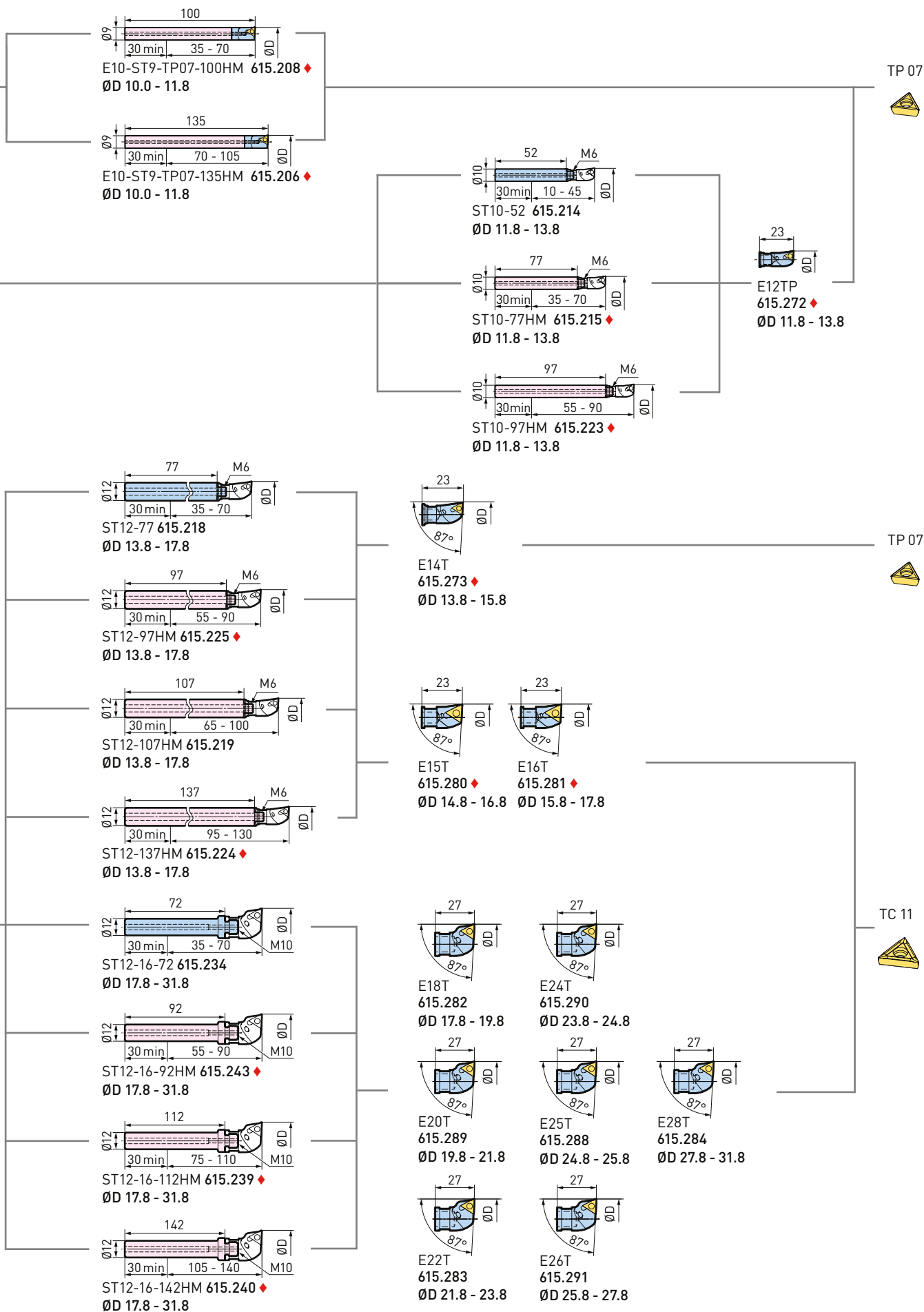

B.2

Boring Head

Order No.

EWN04-22CK4

112.206

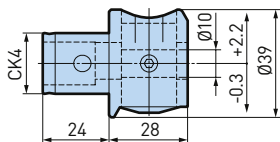

EWN04-22ES25

112.205

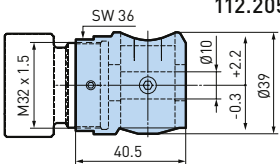

EWN04-22HSK-E40

112.207

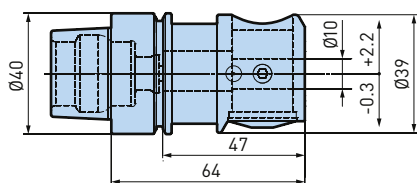

RB10-4
613.204

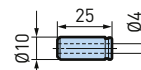

RB10-3.5
613.202

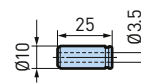

RB10-4.5
613.203

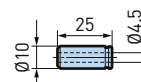

RB10-5
613.205

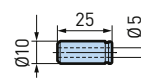

RB10-6
613.206

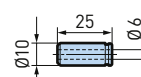

RB10-7
613.207

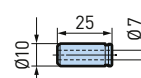

RB10-8
613.208

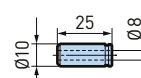

Reduction Sleeve for ER

Model	Order No.	A1
TB-ES25-ES20	112.271	M25 x 1.5
TB-ES25-ES16	112.272	M22 x 1.5

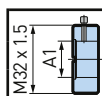

 Carbide tool holders

Fixed Tool Holder

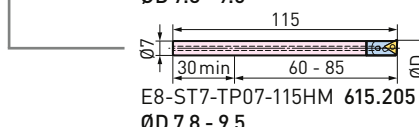
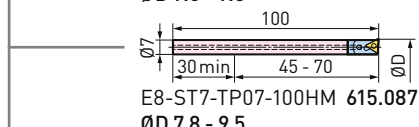
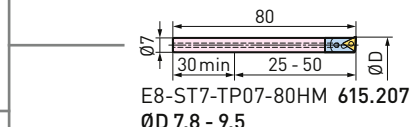
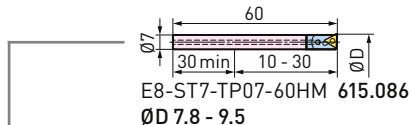
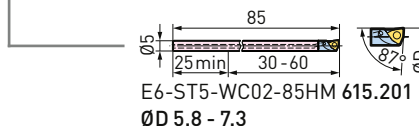
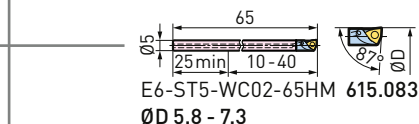
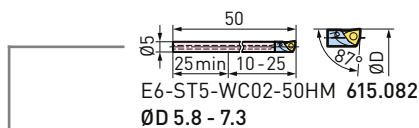
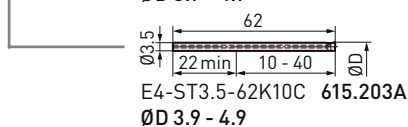
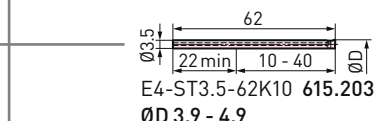
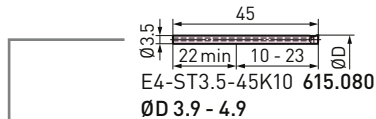
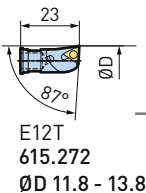
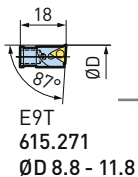
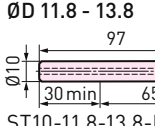
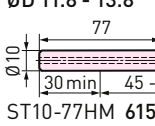
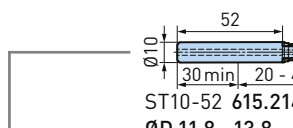
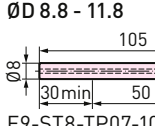
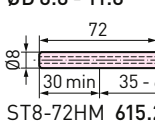
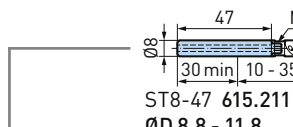
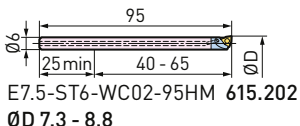
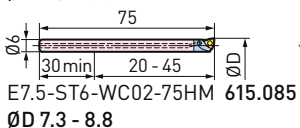
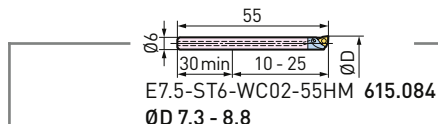
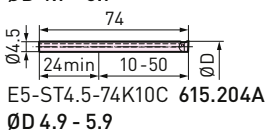
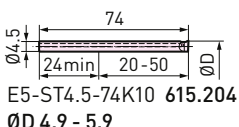
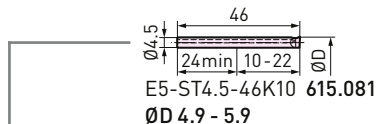
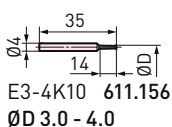
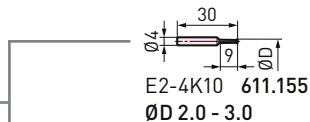

B.2



Boring Head

Order No.

EWN04-22CK4

112.206

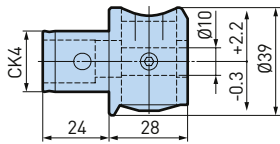

EWN04-22ES25

112.205

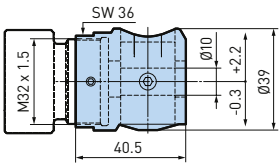

EWN04-22HSK-E40

112.207

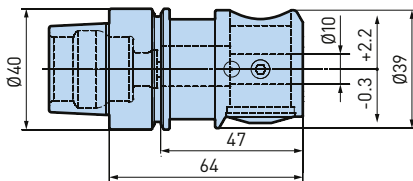

B.2

Reduction Sleeve for ER

	Model	Order No.	A1
	TB-ES25-ES20	112.271	M25 x 1.5
	TB-ES25-ES16	112.272	M22 x 1.5

Fixed Tool Holder

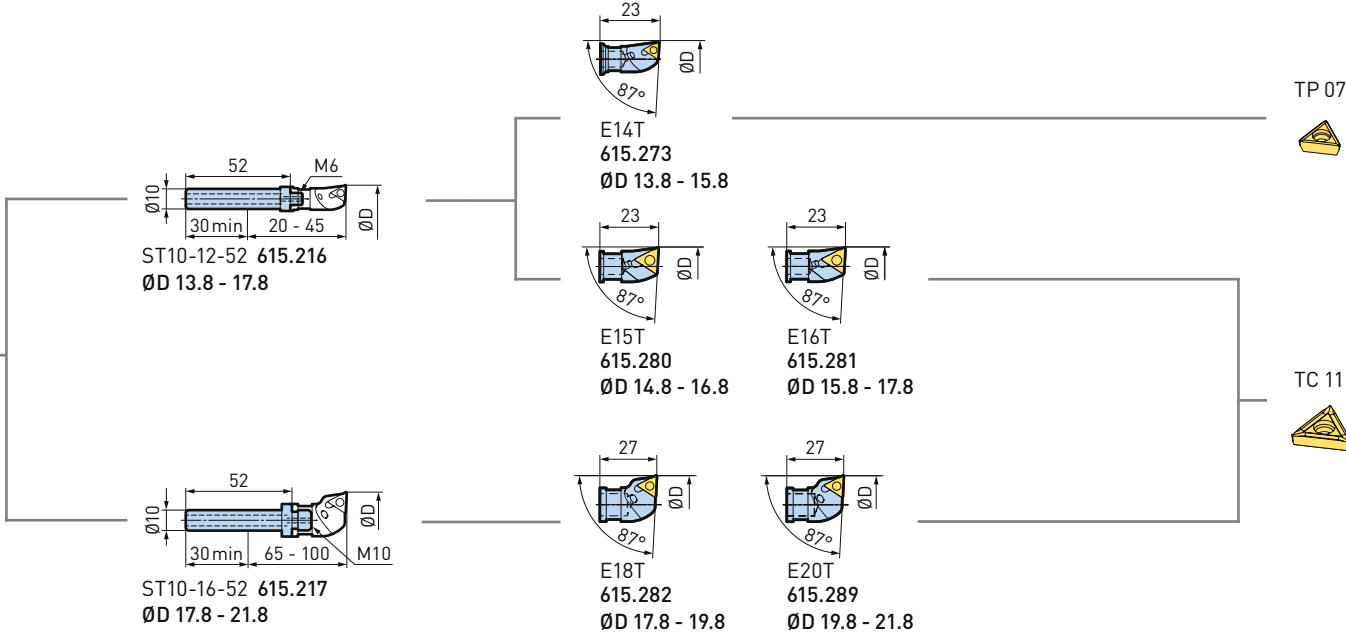

EWN 04-15 Fine Boring Head, Ø 0.4 - 15

Fine boring heads for the machining of smallest bores with highest spindle speeds on small machine tools. The boring heads are available with both modular CK3 connection and cylindrical shanks Ø 16 mm.

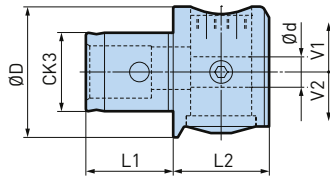

Fig. 1

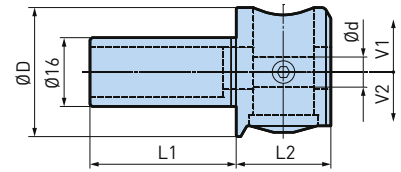
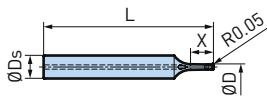

Fig. 2

Model	Order No.	Fig.	Ød	ØD	L1	L2	V1	V2
EWN04-15CK3	112.505	1	7	30	20	22	2	-0.2
EWN04-15ST16	112.506	2	7	30	34	22	2	-0.2

Boring Cutters

Fixed insert type



Model	Order No.	ØD	ØDs	L	X	Cutting material / coating
E0.4-ST7-52K10C	615.522	0.4 - 1	7	52	1.5	K10C
E0.9-ST7-52K10C	615.524	0.9 - 1.5	7	52	3	K10C
E1.4-ST7-52K10C	615.525	1.4 - 2	7	52	5	K10C
E2-ST7-52K10C	615.501	1.9 - 3	7	52	6	K10C
E3-ST7-52K10C	615.502	2.9 - 4	7	52	10	K10C
E4-ST7-52K10C	615.503	3.9 - 5	7	52	13	K10C
E5-ST7-52K10C	615.504	4.9 - 6	7	52	16	K10C

Indexable insert type

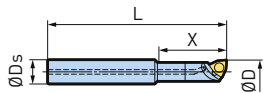

Model	Order No.	ØD	ØDs	L	X	Insert
E6-ST7-WC02-52HM	615.505	5.8 - 7	7	52	20	WC 02
E7-ST7-WC02-52HM	615.506	6.8 - 8	7	52	20	WC 02

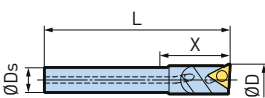

Model	Order No.	ØD	ØDs	L	X	Insert
E8-ST7-TP07-52HM	615.507	7.8 - 9	7	52	30	TP 07
E9-ST7-TP07-52HM	615.508	8.8 - 10	7	52	30	TP 07
E10-ST7-TP07-52HM	615.509	9.8 - 11	7	52	30	TP 07
E12-ST7-TP07-52HM	615.511	11.8 - 15.5	7	52	30	TP 07

OD Turning Cutters

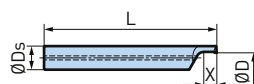

Fig. 1

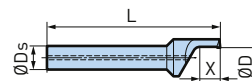
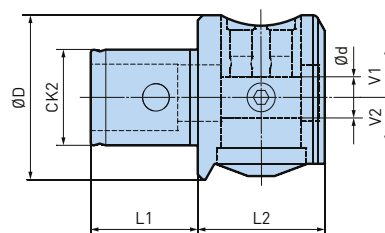

Fig. 2

Model	Order No.	Fig.	ØD	ØDs	L	X	Cutting material / coating
OD-0-3-ST7-52K10C	615.530	1	0.2 - 3	7	52	4	K10C
OD-2-6-ST7-52K10C	615.531	2	2 - 6	7	52	6	K10C

EWN 04-12 Fine Boring Head, Ø 0.4 - 12

Fine boring heads for the machining of smallest bores with highest spindle speeds on machine tools with spindles ISO 20, HSK-E25 and bigger. The boring heads are available with the modular CK2 connection.



Model	Order No.	Ød	ØD	L1	L2	V1	V2
EWN04-12CK2	112.507	6	24	16	19	1.6	-0.2

Boring Cutters

Fixed insert type

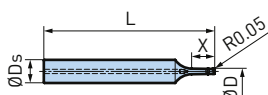

Model	Order No.	ØD	ØDs	L	X	Cutting material / coating
E0.4-ST6-52K10C	615.580	0.4 - 1	6	52	1.5	K10C
E0.9-ST6-52K10C	615.581	0.9 - 1.5	6	52	3	K10C
E1.4-ST6-52K10C	615.582	1.4 - 2	6	52	5	K10C
E2-ST6-52K10C	615.583	1.9 - 3	6	52	6	K10C
E3-ST6-52K10C	615.584	2.9 - 4	6	52	10	K10C

Indexable insert type

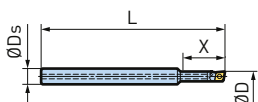

Model	Order No.	ØD	ØDs	L	X	Insert
ST06W-EB4-16	807.019	3.9 - 5	6	70	16	EC03
ST06W-EB5-20	807.020	4.9 - 6	6	75	20	EC03

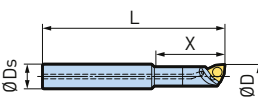

Model	Order No.	ØD	ØDs	L	X	Insert
E6-ST6-WC02-52HM	615.585	5.8 - 7	6	52	20	WC02
E7-ST6-WC02-52HM	615.586	6.8 - 8	6	52	20	WC02

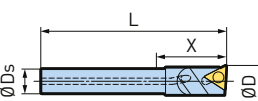

Model	Order No.	ØD	ØDs	L	X	Insert
E8-ST6-TP07-52HM	615.587	7.8 - 9	6	52	30	TP07
E9-ST6-TP07-52HM	615.588	8.8 - 10	6	52	30	TP07
E10-ST6-TP07-52HM	615.589	9.8 - 12	6	52	30	TP07

Inserts ECGM

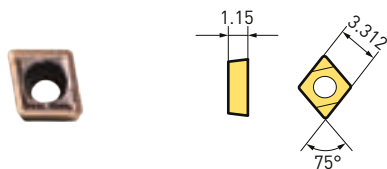

Model	Order No.	Radius [mm]	Cutting material / coating	Aluminium	Construction Steels	Stainless Steels
ECGM03X102ELA(T1500A)	807.017	0.2	Cermet		++	++
ECGM03X102ELA(H1)	807.018	0.2	K10	++		

1. Inserts are available in a packet of 10 pcs.

Clamping Screw

Model	Order No.	Insert
S1.6S-T3-S	807.040	ECGM03X102ELA(T1500A) / ECGM03X102ELA(H1)

1. Clamping Screws are available in a packet of 10 pcs.

EWN 04-24/12-36 Fine Boring Head, $\varnothing 0.4 - 36$

Special fine boring heads with wide diameter range for the micro industry.
Dedicated cutters for OD turning and face grooving available.

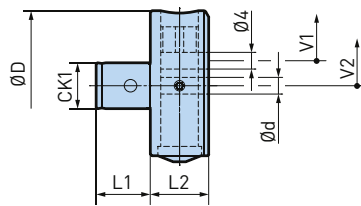

Fig. 1

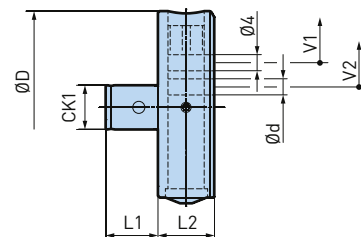

Fig. 2

Model	Order No.	Fig.	$\varnothing d$	$\varnothing D$	L1	L2	V1	V2
EWN04-24CK1	188.133	1	4	36	13	14	6	6
EWN12-36CK1	188.134	2	4	48	13	14	6	6

OD Turning



Fine Boring



Face Grooving



EWN 04-7 Fine Boring Head, Ø 0.4 - 7

The world's smallest fine boring head: Thanks to its body diameter of only Ø 18.5 mm, the EWN 04-7 is the perfect solution for micro machining applications.

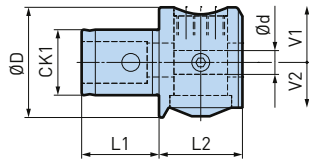

Fig. 1

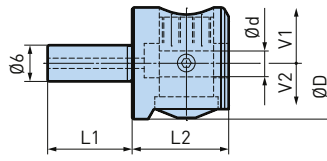

Fig. 2

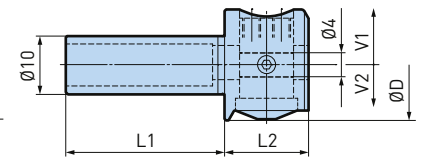

Fig. 3

Model	Order No.	Fig.	Ød	ØD	L1	L2	V1	V2
EWN04-7CK1	112.503	1	4	18.5	13	14	1.05	-0.1
EWN04-7CKB1-N	100182.001.0	1	4	18.5	27	14	1.05	-0.1
EWN04-7ST6	112.508	2	4	18.5	14	16	1.05	-0.1
EWN04-7ST10	112.504	3	4	18.5	25	14	1.05	-0.1

Boring Cutters

Fixed insert type

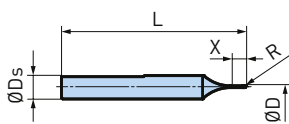

Fig. 1

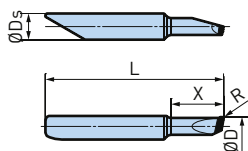

Fig. 2

Model	Order No.	Fig.	ØD	ØDs	L	X	R	Cutting material / coating
E0.4-ST4-25K10C	615.561	1	0.4 - 0.6	4	25	1.1	0.1	K10C
E0.4-ST4-25K10	615.551	1	0.4 - 0.6	4	25	1.1	0.1	K10
E0.4-ST4-30K10C	615.541	1	0.4 - 0.9	4	30	1.5	0.05	K10C
E0.6-ST4-25K10C	615.562	1	0.6 - 0.8	4	25	1.5	0.1	K10C
E0.6-ST4-25K10	615.552	1	0.6 - 0.8	4	25	1.5	0.1	K10
E0.8-ST4-25K10C	615.563	1	0.8 - 1.2	4	25	2	0.1	K10C
E0.8-ST4-25K10	615.553	1	0.8 - 1.2	4	25	2	0.1	K10
E0.9-ST4-30K10C	615.542	1	0.9 - 1.4	4	30	3	0.05	K10C
E1.2-ST4-25K10C	615.564	1	1.2 - 1.5	4	25	2.5	0.1	K10C
E1.2-ST4-25K10	615.554	1	1.2 - 1.5	4	25	2.5	0.1	K10
E1.4-ST4-30K10C	615.543	1	1.4 - 2	4	30	5	0.05	K10C
E1.5-ST4-25K10C	615.565	1	1.5 - 1.9	4	25	3.5	0.2	K10C
E1.5-ST4-25K10	615.555	1	1.5 - 1.9	4	25	3.5	0.2	K10
E1.9-ST4-25K10C	615.566	1	1.9 - 3	4	25	4.5	0.2	K10C
E2-ST4-30K10C	615.544	1	1.9 - 3	4	30	6	0.05	K10C
E3-ST4-30K10C	615.545	1	2.9 - 4	4	30	10	0.05	K10C
E4-ST4-30K10C	615.546	1	3.9 - 5	4	30	13	0.05	K10C
E5-ST4-30K10C	615.547	1	4.9 - 7	4	30	16	0.05	K10C
E1.4-ST4-24CBN20	615.571	2	1.4 - 2	4	25	3.5	0.1	CBN-20
E1.9-ST4-24CBN20	615.572	2	1.9 - 3	4	25	4.5	0.1	CBN-20
E2.9-ST4-27CBN20	615.573	2	2.9 - 4	4	25	8	0.1	CBN-20
E3.9-ST4-30CBN20	615.574	2	3.9 - 5	4	25	11	0.1	CBN-20
E4.9-ST4-30CBN20	615.575	2	4.9 - 6	4	25	16	0.1	CBN-20

B.2

OD Turning Cutter

The boring cutters are made with flat for cutting edge orientation.

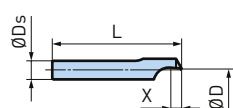

Model	Order No.	ØD	ØDs	L	X	Cutting material / coating
OD-0.2-2.3-ST4-25K10C	615.590	0.2 - 2.3	4	25	2.2	K10C

Fine Boring Heads with Peripheral Cutting Edge

Overview	436
EWE Digital Fine Boring Heads	437
EWN Smart Damper Fine Boring Heads	438
EWN Fine Boring Heads	439
EWN BIG CAPTO Fine Boring Heads	440
Accessories	441
EWB/EWB-AL Balanced Fine Boring Heads	446
EWB-UP Balanceable Fine Boring Heads	447
EW Fine Boring Heads	448
Carbide Bars	449
Guidelines & Troubleshooting	451



EWE Digital Fine Boring Heads

Wireless communication for easy readout with the BIG KAISER app:
The brandnew EWE fine boring heads revolutionate fine boring.
Ø 25 - 203 mm, CKB1-CKB7



EWN Smart Damper fine boring head

The combination of the most advanced technologies to a powerful and highly productive tool: an integral fine boring head with an innovative and patented damping technology.
Ø 20 - 150 mm, CKB1-CKB2/CKB3-CKB7



EWN Fine Boring Heads

The EWN single cutter boring tool program for fine boring covers a range of Ø 20 - 203 mm with only 7 precision boring heads. Due to the optimized balance over the whole adjustment range, cutting speeds up to 1200 m/min are permitted.
Ø 20 - 203 mm, CKB1-CKB7/BIG CAPTO C3-C8



EWB Balanced Fine Boring Heads

Even at max. speeds the balanced EWB fine boring heads guarantee vibration-free boring, resulting in increased productivity and highest precision.
Ø 32 - 105 mm, CK3-CK6

B.3



EWB-AL Balanced Fine Boring Head

The fine boring heads EWB AL are made of high strength aluminium with hard coating. Together with reductions and extensions made in the same way, the weight for long and large diameter tool combinations is reduced by more than 50%.
Ø 100 - 203 mm, CK6-CK7



EWB-UP Balanceable Fine Boring Heads

The ultra-precision EWB-UP series sets higher standards for boring heads concerning adjustment accuracy and balance quality.
Ø 25 - 100 mm, CK2-CK6



EW Fine Boring Heads

These heads are designed to be used in combination with the steel or carbide-boring bars Ø 14 and Ø 16 mm out of the accessory program. In conjunction with the long carbide bar, the tool is well suited for vibration-free finishing operations in bores with unfavorable Ø/L-ratios.
Ø 15 - 22 mm, ES15/ES18

EWE Digital Fine Boring Heads, Ø 25 - 203

Thanks to wireless communication with the BIG KAISER app, manufacturing precise bores has become very easy.

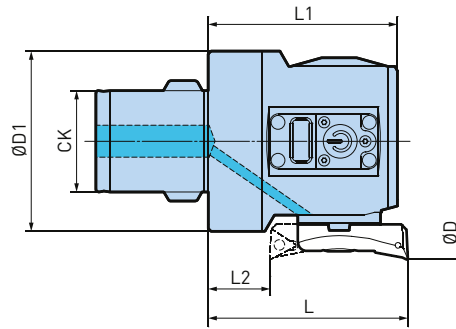
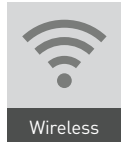

Model	Order No.	CK	ØD	Back Boring ØD	ØD1	L	L1	L2
EWE25-47CKB2	310.820	CKB2	25 - 47	-	23.4	35.5	32.5	-
EWE41-74CKB4	310.840	CKB4	41 - 74	53 - 74	38	47	43	14
EWE53-95CKB5	310.850	CKB5	53 - 95	62 - 95	49	57	53	19
EWE68-150CKB6	310.860	CKB6	68 - 150	80 - 150	64	71	67.2	22
EWE100-203CKB6	310.865	CKB6	100 - 203	112 - 203	64 / 90 *	71	67.2	22
EWE100-203CKB7	310.870	CKB7	100 - 203	112 - 203	90	87	83.2	38

- * Max. body diameter: 90 mm
- Insert holder is to be ordered separately.
- EWE25-47CKB2 does not have a display on the body. An external device containing the BIG KAISER APP, or using the EWE Reader, is required.

Accessories & Spare Parts

Insert Holders Type E	Insert Holder Type C	Accessories	EWE Reader
			
▶ 441	▶ 442	▶ 507-508	▶ 398

B.3

BIG KAISER App

The new app simplifies the assembly and operation of rough and fine boring heads and provides extremely accurate cutting data. The various parameters can be saved in the app for later use, an important building block for workshops that want to get into smart manufacturing. The app currently supports 61 BIG KAISER fine and reaming heads with diameters from 0.4 mm - 620 mm.

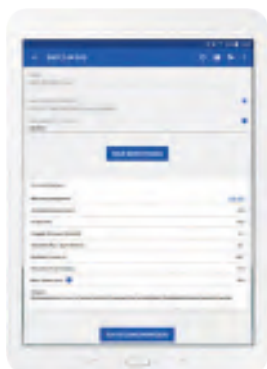

Cutting data



Send your data to...



History (made automatically)

This is how the app is going to support your daily challenges

1. Choose your tool
2. Type in your application values
3. Calculate cutting data
4. Adjust machine and make a measuring bore
5. Infeed tool with the diameter of the measuring bore
6. Make the bore middle tolerance

EWN Smart Damper Fine Boring Head, Ø 20 - 203

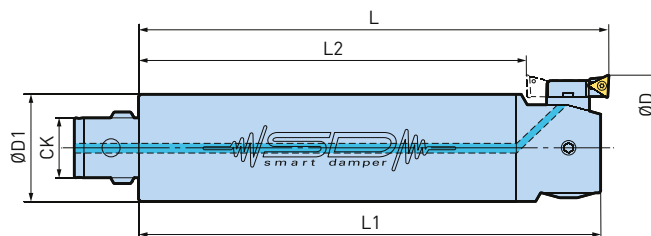

Model	Order No.	CK	ØD	Back Boring ØD	ØD1	L	L1	L2
CK1-EWN20DP-100	807.400	CK1	20 - 36	28 - 36	19	100	97	78
CK2-EWN25DP-125	807.401	CK2	25 - 47	42 - 47	24	125	122	101
CKB3-EWN32DP-160	807.016	CKB3	32 - 60	57 - 60 **	31	160	155	130
CKB4-EWN41DP-185	806.742	CKB4	41 - 74	61 - 74 *	39	185	181	152
CKB5-EWN53DP-210	806.743	CKB5	53 - 95	74 - 95 *	50	210	206	172
CKB6-EWN68DP-240	806.744	CKB6	68 - 150	90 - 150	64	240	236.2	191
CKB6-EWN100DP-240	807.185	CKB6	100 - 203	107 - 203	64	240	236.2	191
CKB7-EWN100DP-240	807.186	CKB7	100 - 203	116 - 203	90	240	236.2	191

1. Insert holder (type 1) included. Other sizes are available.
2. * Use insert holders type 2 or 3 for back boring.
3. ** Use insert holders Type 3 for back boring.

B.3

Accessories & Spare Parts

Insert Holders Type E	Insert Holder Type C	Accessories
		
▶ 441	▶ 442	▶ 507-508

EWN Fine Boring Heads, Ø 20 - 203

The EWN single cutter boring tool program for fine boring covers a range of Ø 20 - 203 mm with only 7 fine boring heads. Due to the optimized balance over the whole adjustment range, cutting speeds up to 1200 m/min are permitted.

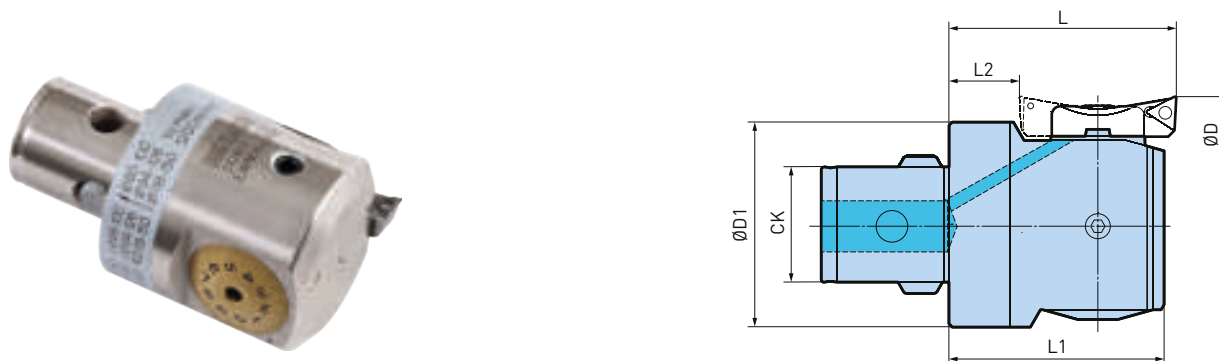

Model	Order No.	CK	ØD	Back Boring ØD	ØD1	L	L1	L2
EWN20-36CKB1	310.101	CKB1	20 - 36	28 - 36	18.5	32.5	29.5	10.5
EWN25-47CKB2	310.201	CKB2	25 - 47	36 - 47	23.4	35.5	32.5	11.5
EWN32-60CKB3	310.301	CKB3	32 - 60	46 - 60	30	40	35	10
EWN41-74CKB4	310.401	CKB4	41 - 74	53 - 74	38	47	43	14
EWN53-95CKB5	310.501	CKB5	53 - 95	62 - 95	49	57	53	19
EWN68-150CKB6	310.601	CKB6	68 - 150	80 - 150	64	71	67.2	22
EWN100-203CKB6	310.602	CKB6	100 - 203	112 - 203	90	71	67.2	22
EWN100-203CKB7-87	310.701	CKB7	100 - 203	112 - 203	90	87	83.2	38
EWN100-203CKB7-117	310.708	CKB7	100 - 203	112 - 203	90	117	113.2	68

1. Insert holder is to be ordered separately.

Accessories & Spare Parts

Insert Holders Type E	Insert Holder Type C	Accessories
		
▶ 441	▶ 442	▶ 507-508

EWN BIG CAPTO Fine Boring Heads, Ø 32 - 203

With only 5 fine boring heads, the diameter range from Ø 32-203 mm is completely covered. The boring heads can be clamped in BIG CAPTO shanks and other polygonal basic holders, or directly in CAPTO machine spindles.

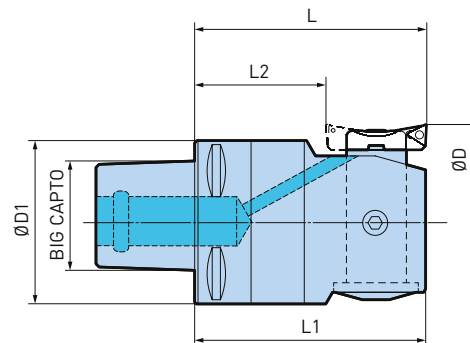

Model	Order No.	BIG CAPTO	ØD	Back Boring ØD	ØD1	L	L1	L2
EWN32-60C3	470.301	C3	33 - 60	46 - 60	32	55	50	25
EWN41-74C4	470.401	C4	41 - 74	53 - 74	40	67	63	34
EWN53-95C5	470.501	C5	53 - 95	62 - 95	50	77	73	39
EWN68-150C6	470.601	C6	68 - 150	80 - 150	64	92	88	43
EWN100-203C6	470.602	C6	100 - 203	112 - 203	90	92	88	43
EWN100-203C8	470.801	C8	100 - 203	112 - 203	90	117	113	68

1. Insert holder is to be ordered separately.

Accessories & Spare Parts

Insert Holders Type E	Insert Holder Type C	Accessories
		
▶ 441	▶ 442	▶ 507-508

Insert Holders Type E

Standard holder with 87° entering angle, suitable for fine boring in through and blind holes. Three different insert holders for the extension of the diameter range and for back boring applications.

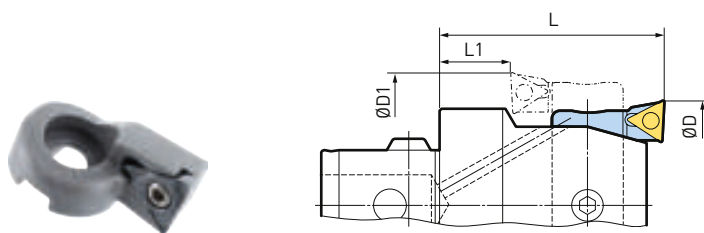

Fig. 1

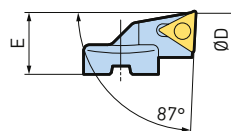

Fig. 2

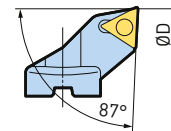



Fig. 3

Model	Order No.	Head	Type	ØD	Back Boring ØD	L	L1	E	Insert
ENH1-1T	626.111	EWN20	1	20 - 26	-	32.5	10.5	4.65	TP 07
ENH1-2T	626.112	EWN20	2	25 - 31	28 - 31	32.5	10.5	7.15	TP 07
ENH1-3T	626.113	EWN20	3	30 - 36	30 - 36	32.5	10.5	9.65	TP 07
ENH2-1T	626.121	EWN25	1	25 - 33	-	35.5	11.5	5.45	TP 07
ENH2-2T	626.122	EWN25	2	32 - 40	36 - 40	35.5	11.5	8.95	TP 07
ENH2-3T	626.123	EWN25	3	39 - 47	39 - 47	35.5	11.5	12.45	TP 07
ENH3-1T	626.131	EWN32	1	32 - 42	-	40	10	7.4	TC 11
ENH3-2T	626.132	EWN32	2	41 - 51	46 - 51	40	10	11.9	TC 11
ENH3-3T	626.133	EWN32	3	50 - 60	50 - 60	40	10	16.4	TC 11
ENH4-1T	626.141	EWE/EWN41	1	41 - 54	-	47	14	8.1	TC 11
ENH4-2T	626.142	EWE/EWN41	2	50 - 63	53 - 63	47	14	12.6	TC 11
ENH4-3T	626.143	EWE/EWN41	3	61 - 74	61 - 74	47	14	18.1	TC 11
ENH5-1T	626.151	EWE/EWN53	1	53 - 70	62 - 70	57	19	10	TC 11
ENH5-2T	626.152	EWE/EWN53	2	65 - 82	69 - 82	57	19	16	TC 11
ENH5-3T	626.153	EWE/EWN53	3	78 - 95	78 - 95	57	19	22.5	TC 11
ENH6-1T	626.161	EWE/EWN68	1	68 - 100	80 - 100	71	22	12.5	TC 11
ENH6-2T	626.162	EWE/EWN68	2	94 - 126	94 - 126	71	22	25.5	TC 11
ENH6-3T	626.163	EWE/EWN68	3	118 - 150	118 - 150	71	22	37.5	TC 11
ENH6-1T	626.161	EWE/EWN100	1	100 - 153	112-153	71/87/117	22/38/68	12.5	TC 11
ENH6-2T	626.162	EWE/EWN100	2	126 - 179	126-179	71/87/117	22/38/68	25.5	TC 11
ENH6-3T	626.163	EWE/EWN100	3	150 - 203	150-203	71/87/117	22/38/68	37.5	TC 11

B.3

Accessories & Spare Parts

Inserts TC	Inserts TP
 <p>► 472</p>	 <p>► 471</p>

Insert Holder Type C

With 90° approach angle, suitable for semi-finish and finish boring and for stepped bores. For each boring head, insert holders with different projections are available for extension of the boring range and back boring.

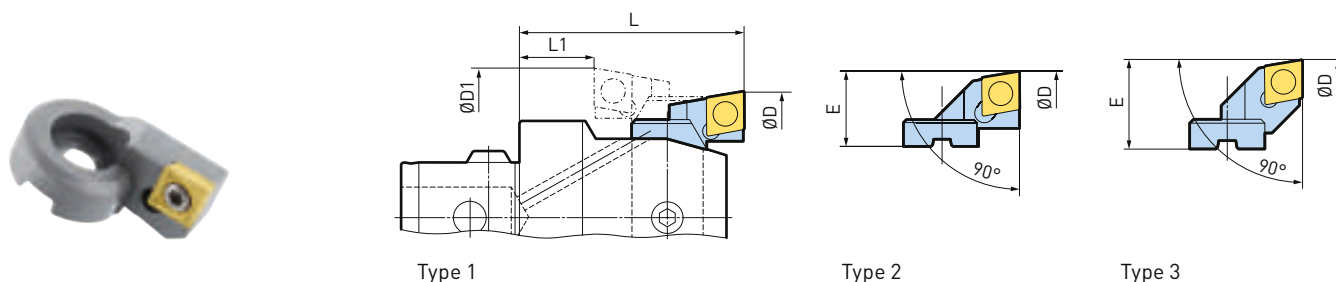

Model	Order No.	Head	Type	ØD	ØD1	L	L1	E	Insert
ENH2-2C	626.322	EWN25	2	33 - 41	37-41	35.5	11.5	9.5	CC 06
ENH2-3C	626.323	EWN25	3	39 - 47	39-47	35.5	11.5	12.5	CC 06
ENH3-1C	626.331	EWN32	1	32 - 42	-	40	10	7.4	CC 06
ENH3-2C	626.332	EWN32	2	41 - 51	47-51	40	10	11.9	CC 06
ENH3-3C	626.333	EWN32	3	50 - 60	50-60	40	10	16.4	CC 06
ENH4-1C	626.341	EWE/EWN41	1	41 - 54	-	47	14	8.1	CC 06
ENH4-2C	626.342	EWE/EWN41	2	50 - 63	54-63	47	14	12.6	CC 06
ENH4-3C	626.343	EWE/EWN41	3	61 - 74	61-74	47	14	18.1	CC 06
ENH5-1C	626.351	EWE/EWN53	1	53 - 70	62-70	57	19	10	CC 06
ENH5-2C	626.352	EWE/EWN53	2	62 - 79	67-79	57	19	14.5	CC 09
ENH5-3C	626.353	EWE/EWN53	3	78 - 95	78-95	57	19	22.5	CC 09
ENH6-1C	626.361	EWE/EWN68	1	68 - 100	80-100	71	22	12.5	CC 09
ENH6-2C	626.362	EWE/EWN68	2	78 - 110	82-110	71	22	17.5	CC 09
ENH6-3C	626.363	EWE/EWN68	3	108 - 140	108-140	71	22	32.5	CC 09
ENH6-1C	626.361	EWE/EWN100	1	100 - 153	112-153	71/87/117	22/38/68	12.5	CC 09
ENH6-2C	626.362	EWE/EWN100	2	110 - 163	110-163	71/87/117	22/38/68	17.5	CC 09
ENH6-3C	626.363	EWE/EWN100	3	140 - 193	140-193	71/87/117	22/38/68	32.5	CC 09

B.3

Blank Insert Holder Type ENH

If required, the blanks can be hardened. [Mat. 1.2343]

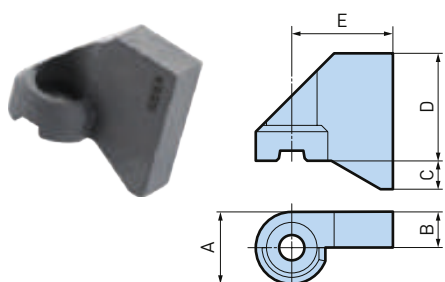

Model	Order No.	Head	A	B	C	D	E
ENH1-B	626.901	EWN20	8.4	4.2	2.61	11	11.8
ENH2-B	626.902	EWN25	10.4	5.2	3.16	10	17.2
ENH3-B	626.903	EWN32	11.4	5.7	4.5	17	16
ENH4-B	626.904	EWN41	15.4	7.7	5	20	20
ENH5-B	626.905	EWN53	19	9.5	-	25	20
ENH6-B	626.906	EWN68;EWN100	29	14.5	-	40	26
ENH6-BLANK L	626.916	EWN68;EWN100	29	14.5	-	40	50

Accessories & Spare Parts

Inserts CC



► 475

Insert Holders 30°/45° TP07



Fig. 1

Fig. 2

Model	Order No.	Fig.	Head	ØD	E	C1	C2	Insert
ENH2-1T30	626.422	1	EWN25	28 - 36	6.95	35.5	29.8	TP 07
ENH2-1T45	626.423	2	EWN25	28 - 36	6.95	35.5	30.8	TP 07

Insert Holders 30°/45°/25° TC11

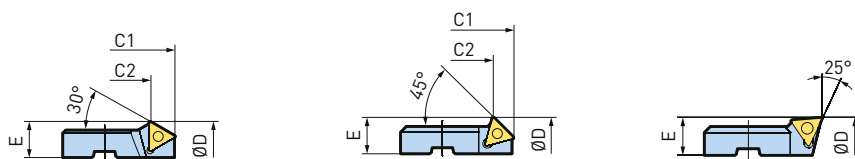

Fig. 1

Fig. 2

Fig. 3

Model	Order No.	Fig.	Head	ØD	E	C1	C2	Insert
ENH3-1T25	689.197	3	EWN32	32 - 42	7.4	-	-	TC 11
ENH3-1T30	626.432	1	EWN32	36 - 46	9.4	42	33.3	TC 11
ENH3-1T45	626.433	2	EWN32	36 - 46	9.4	42	34.8	TC 11
ENH4-1T25	689.198	3	EWN41	41 - 54	8.1	-	-	TC 11
ENH4-1T30	626.442	1	EWN41	45 - 58	10.1	49	40.3	TC 11
ENH4-1T45	626.443	2	EWN41	45 - 58	10.1	49	41.8	TC 11
ENH5-1T25	689.001	3	EWE/EWN53	53 - 70	10	-	-	TC 11
ENH5-1T30	626.452	1	EWE/EWN53	56 - 73	11.5	57	48.4	TC 11
ENH5-1T45	626.453	2	EWE/EWN53	56 - 73	11.5	57	49.8	TC 11
ENH6-1T25	689.007	3	EWE/EWN68	68 - 100	12.5	-	-	TC 11
ENH6-1T30	626.462	1	EWE/EWN68	68 - 100	12.5	87	78.3	TC 11
ENH6-1T45	626.463	2	EWE/EWN68	68 - 100	12.5	87	79.8	TC 11
ENH6-1T25	689.007	3	EWE/EWN100	100 - 153	12.5	-	-	TC 11
ENH6-1T30	626.462	1	EWE/EWN100	100 - 153	12.5	87	78.3	TC 11
ENH6-1T45	626.463	2	EWE/EWN100	100 - 153	12.5	87	79.8	TC 11

B.3

Back Boring Instructions

For back boring, it is required to enter into the bore off centre, with a tool adjusted to the back bore diameter. In this respect, the back bore diameter «ØD» as well as the diameters of the entry bore «C» and the tool body «ØD1», are related to each other. In order to check the feasibility of the back boring operation and to select the best possible tool combination, these values can be calculated as follows:

Example:

Calculation of the minimum entry bore diameter «C».

Given:

- Back bore diameter ØD = 93 mm
- Tool combination EWN53, with Insert holder no. 3, ØD1 = 50 mm

$$C = \frac{\text{ØD} + \text{ØD1}}{2} = \frac{93 + 50}{2} = 71.5 \text{ mm}$$

Caution:

- Counter clockwise spindle rotation is required for back boring operations.
- The cutting edge is at a shorter length than the boring head. Consider total length of tool. Check the space at the back side of the work piece.

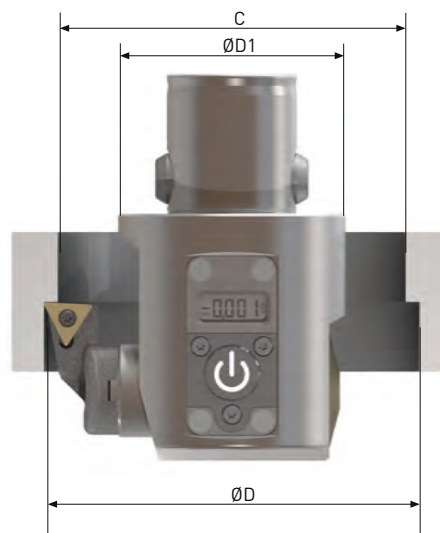

Min. entry bore diameter «C»

$$C = \frac{\text{ØD} + \text{ØD1}}{2}$$

Max. back bore diameter «ØD»

$$\text{ØD} = 2C - \text{ØD1}$$

Max. tool body diameter «ØD1»

$$\text{ØD1} = 2C - \text{ØD}$$

Face Grooving with EWN/EWE, Ø 53 - 3040

The insert holders and inserts are made for face grooving with the fine boring heads EWN and EWE Series 310 and with the large diameter boring tools Series 317 und 318.

Insert Holders



Type 1

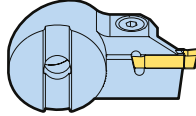

Type 1

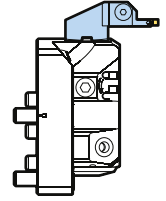
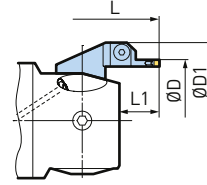

Type 2

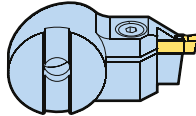

Type 2

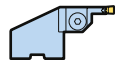
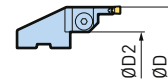

EWN/EWE 310

EWN/EWE 200

For Boring Head	Insert holder									
	Type 1				Type 2				L *	L1
	ØD	ØD1	Model	Order No.	ØD	ØD2	Model	Order No.		
EWN/EWE53 (310.501)/(310.850)	53 - 70	ØD + 22	ENH5-1FG4	626.935	73 - 90	ØD - 30	ENH5-1FG4R	626.945	73	20
EWN/EWE68 (310.601)/(310.860)	68 - 100	ØD + 24	ENH6-1FG4	626.936	88 - 120	ØD - 28	ENH6-2FG4R	626.946	88	21
	94 - 126		ENH6-2FG4	626.937	114 - 146		ENH6-3FG4R	626.947		
EWN/EWE100 (310.602)/(310.865)	100 - 153	ØD + 24	ENH6-1FG4	626.936	120 - 173	ØD - 28	ENH6-2FG4R	626.946	88	21
	126 - 179		ENH6-2FG4	626.937	146 - 199		ENH6-3FG4R	626.947		
EWN/EWE100 (310.701)/(310.870)	100 - 153	ØD + 24	ENH6-1FG4	626.936	120 - 173	ØD - 28	ENH6-2FG4R	626.946	104	21
	126 - 179		ENH6-2FG4	626.937	146 - 199		ENH6-3FG4R	626.947		
EWN100L (310.708)	100 - 153	ØD + 24	ENH6-1FG4	626.936	120 - 173	ØD - 28	ENH6-2FG4R	626.946	134	21
	126 - 179		ENH6-2FG4	626.937	146 - 199		ENH6-3FG4R	626.947		
EWN/EWE200 (318.101)/(318.104)	200 - 3000	ØD + 21	ENH7-1FG4	626.938	220 - 3040	ØD - 28	ENH7-2FG4R	626.948	134	21

1. * Tool length to the CK connection.

B.3

Inserts

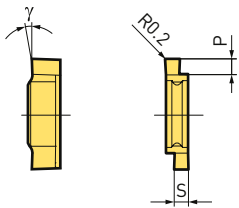

Inserts for Steel and Cast Iron			
S	P	g	Order No.
2.5	2.7	5°	958.425
3.0	3.3	5°	958.430
3.3	3.6	5°	958.433
3.5	3.8	5°	958.435
4.0	4.3	5°	958.440

Inserts for Aluminium			
S	P	g	Order No.
2.5	2.7	15°	958.475
3.0	3.3	15°	958.480
3.3	3.6	15°	958.483
3.5	3.8	15°	958.485
4.0	4.3	15°	958.490

Groove Dimensions

Recommended groove dimensions for given cross section diameters of O-rings, for static sealing.

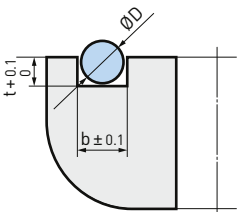

ØD	Groove Width b	Groove Depth t
1.78	2.5	1.3
2.0	2.5	1.6
2.5	3.3	1.9
2.62	3.5	2.05
3.0	4.0	2.4

Work Piece Material	Vc m/min	fn mm/rev
Construction-heat treatable steels	120 - 200	0.01 - 0.03
Stainless steels	60 - 120	0.01 - 0.02
Cast iron	80 - 160	0.02 - 0.04
Aluminium	200 - 400	0.02 - 0.04
Non-ferrous metals		

OD Turning with EWN/EWE/SW, Ø 16 - 120

Our standard fine and rough boring tools (EWN, EWE and SW) can be used for outer diameter turning with the OD turning bridge. Wide range is covered by 5 bridges.

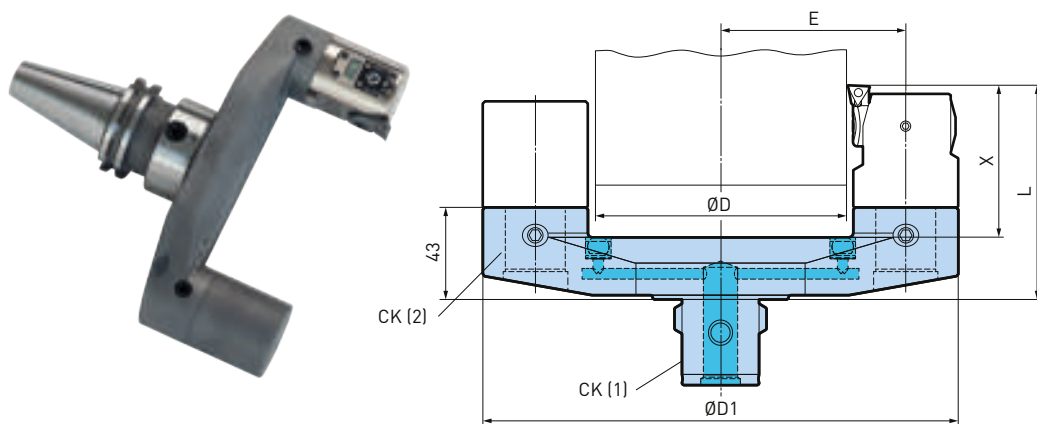

Accessories & Spare Parts



Model	Order No.	ØD	ØD1	E	L	X	CK (1)	CK (2)
OD16-44CKB5-CKB3	335.906	16 - 44	107	38	83 [113] [128]	51 [81] [96]	CKB5	CKB3
OD16-44CKB6-CKB3	335.905	16 - 44	107	38	83 [113] [128]	51 [81] [96]	CKB6	CKB3
OD34-67CKB6-CKB4	335.904	34 - 67	147	54	90 [130] [150]	58 [98] [118]	CKB6	CKB4
OD57-90CKB6-CKB4	335.903	57 - 90	170	65.5	90 [130] [150]	58 [98] [118]	CKB6	CKB4
OD78-120CKB6-CKB5	335.902	78 - 120	222	86.5	100 [160] [190]	68 [128] [158]	CKB6	CKB5

1. The numbers in brackets indicate the tool length (L) and the max. pin length (X) with the use of the corresponding extensions.
2. Attention: Counter-clockwise rotation of spindle! Vc max. 450m/min

B.3

Counter Weight for OD Turning

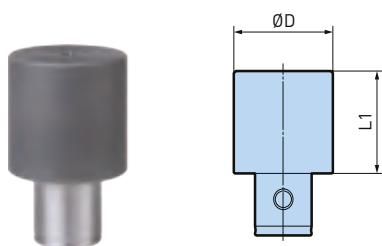

Model	Order No.	CK	ØD	L1
CW-CK3	335.915	CK3	31.3	35
CW-CK4	335.913	CK4	39	36.4
CW-CK5	335.912	CK5	49	49.5

1. For use of SW / EWN / EWE boring head

Selection of the Insert Holder

Fine Boring

Rough Boring

ØD	Tool Holder	For Boring Head	Range ØD Insert Holder Order No.		
16 - 44	335.905	EWN32	16 - 26	25 - 35	34 - 44
16 - 44	335.906	EWN32	16 - 26	25 - 35	34 - 44
		310.301	626.133	626.132	626.131
34 - 67	335.904	EWE/EWN41	34 - 47	45 - 58	54 - 67
57 - 90	335.903	EWE/EWN41	57 - 70	68 - 81	77 - 90
		310.840/310.401	626.143	626.142	626.141
78 - 120	335.902	EWE/EWN53	78 - 95	91 - 108	103 - 120
		310.850/310.501	626.153	626.152	626.151

ØD	Tool Holder	For Boring Head	Range ØD Insert Holder Order No.	
25 - 44	335.905	SW32	25 - 35	34 - 44
25 - 44	335.906	SW32	25 - 35	34 - 44
		319.301	639.437	639.433
42 - 67	335.904	SW41	42 - 55	54 - 67
65 - 90	335.903	SW41	65 - 78	77 - 90
		319.401	639.447	639.443
87 - 120	335.902	SW53	87 - 104	103 - 120
		319.501	639.457	639.453

EWB Balanced Fine Boring Head, Ø 32 - 105

Even at max. speeds balanced tools guarantee vibration-free boring, resulting in increased productivity and highest precision.

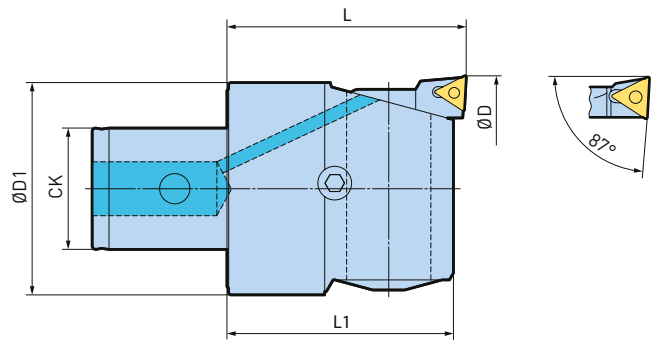

Model	Order No.	CK	ØD	ØD1	L	L1	Insert
EWB32-42CK3	310.305A	CK3	32 - 42	30	40	37	TP 07
EWB41-54CK4	310.405A	CK4	41 - 54	38	47	43	TC 11
EWB53-70CK5	310.505A	CK5	53 - 70	49	57	53	TC 11
EWB68-88CK6	310.605A	CK6	68 - 88	63	71	67.2	TC 11
EWB85-105CK6	310.606A	CK6	85 - 105	63	71	67.2	TC 11

1. EWB boring heads will be delivered with assembled insert holder.
2. Inserts are not included.

EWB-AL Balanced Fine Boring Head, Ø 100 - 203

The fine boring heads EWB-AL are made of high strength aluminium with hard coating. Together with fitting reductions and extensions, the weight for long and large diameter tool combinations is reduced by more than 50%.

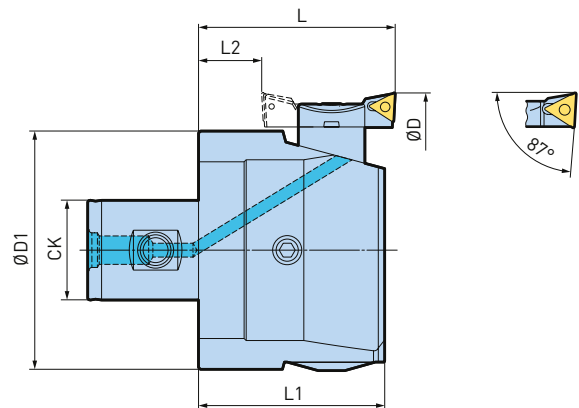

Model	Order No.	CK	ØD	Back Boring ØD	ØD1	L	L1	L2	Insert
EWB100-153CK6AL	310.607A	CK6	100 - 153	112 - 153	90	71	67	25	TC 11
EWB100-153CK7AL	310.705A	CK7	100 - 153	112 - 153	90	87	83	41	TC 11
EWB150-203CK6AL	310.608A	CK6	150 - 203	150 - 203	126	71	67	25	TC 11
EWB150-203CK7AL	310.706A	CK7	150 - 203	150 - 203	126	87	83	41	TC 11

1. EWB-AL boring heads will be delivered with assembled insert holder.
2. Inserts are not included.

Accessories & Spare Parts

Insert Holder for EWB	Inserts TC	Accessories
► 507	► 472	► 507-508

EWB-UP Balanceable Fine Boring Head, Ø 25 - 100

The ultra-precise EWB-UP series sets higher standards for boring heads concerning adjustment accuracy and balance quality. Cutting speed up to $V_c \text{ max.} = 2\,000 \text{ m/min.}$

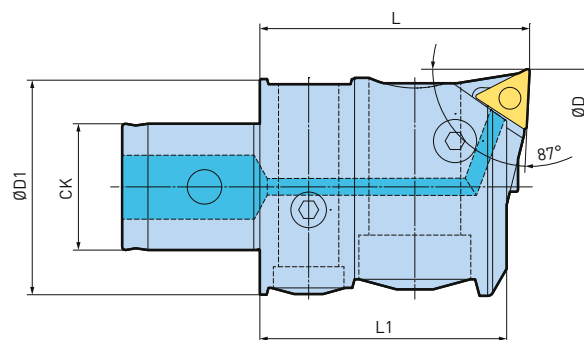

Model	Order No.	CK	ØD	ØD1	L	L1	Max. unbalance (gmm)	Insert
EWB25-33UP-CK2	309.201	CK2	25 - 33	23.4	35.5	32.5	3	TP 07
EWB32-42UP-CK3	309.301	CK3	32 - 42	30	40	37	5	TC 11
EWB41-54UP-CK4	309.401	CK4	41 - 54	38	47	43	5	TC 11
EWB53-70UP-CK5	309.501	CK5	53 - 70	49	57	53	10	TC 11
EWB68-100UP-CK6	309.601	CK6	68 - 100	64	71	67.2	30	TC 11

- EWB-UP boring heads will be delivered with assembled insert holder.
- Inserts are not included.

Accessories & Spare Parts

Inserts TP	Inserts TC	Accessories
		
▶ 471	▶ 472	▶ 507-508

EW Fine Boring Heads, Ø 15 - 22

These heads are designed to be used in combination with the steel or carbide-boring bars Ø 14 and Ø 16 mm from the accessory program. In conjunction with the long carbide bar, the tool is well suited for vibration-free finishing operations in bores with unfavorable Ø/L-ratios.

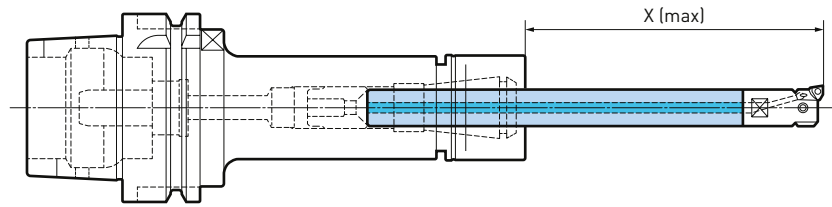

Boring Bars

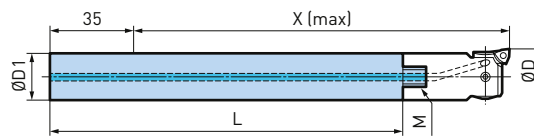

Model	Order No.	Type	ØD	ØD1	M	L	X (max)
ST14-87	615.232	EW15	15 - 18.5	14	M6	87	82
ST14-117HM	615.233	EW15	15 - 18.5	14	M6	117	112
ST14-147HM	615.221	EW15	15 - 18.5	14	M6	147	142
ST16-88	615.226	EW18	18 - 22	16	M10	88	89
ST16-108HM	615.227	EW18	18 - 22	16	M10	108	109
ST16-168HM	615.229	EW18	18 - 22	16	M10	168	169

B.3

EW Fine Boring Heads, Ø 15 - 22

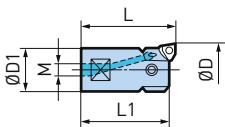

Model	Order No.	ØD	ØD1	L	L1	M
EW15M6	310.020	15 - 18.5	14	30	27.5	M6
EW18M10	310.030	18 - 22	16	36	33	M10

1. Insert holder is to be ordered separately.
2. Inserts are to be ordered separately.

Insert Holders for EW WC02

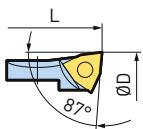

Model	Order No.	Head	ØD	L	Insert
15EKWC02	625.020	EW15 / EW18	15 - 18.5 / 18 - 22	30 / 36	WC 02

1. Inserts are to be ordered separately.

Accessories & Spare Parts

Accessories	Inserts WC
<p>► 507-508</p>	<p>► 470</p>

Carbide Bars ST Ø 20 - 74

Due to maximum rigidity, a carbide bar, optimized in length and with the biggest possible diameter, guarantees the best result when machining deep bores.

For the work range from Ø 20 - 33 [47] mm, the fine graduated carbide bar program contains bars with 6 different diameters and 3 different lengths per diameter. Therefore, for every deep bore machining in this range, the optimal carbide bar is always available. The program is completed with carbide bars Ø 31 and Ø 40 mm in 3 different lengths each, for the boring range from Ø 32 - 54 [74] mm.

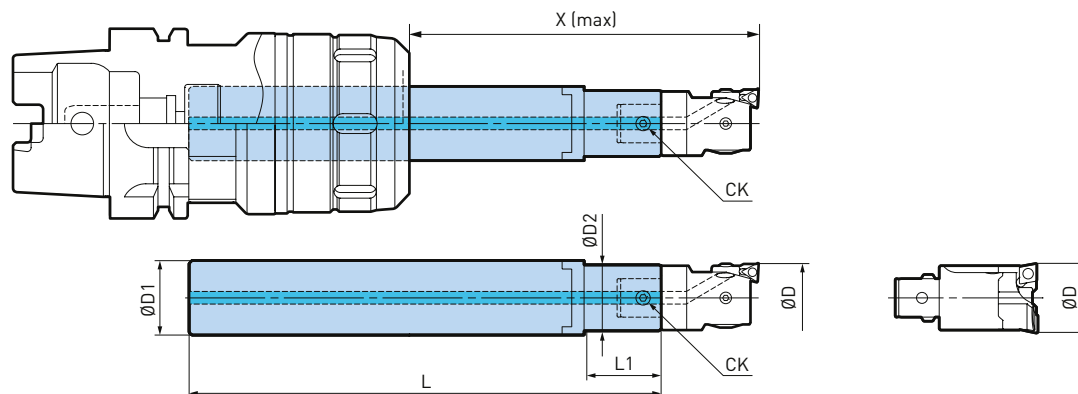

CKB1, CKB2, CKB3, CKB4

Model	Order No.	Head	CK	ØD	ØD1	ØD2	L	L1	HMC X max	MEG-A25N X max	HDC X max
ST19-CKB1-140HM	335.320	SW20,EWN20	CKB1	20 - 36	19	19	140	-	98	120	130
ST19-CKB1-190HM	335.321	SW20,EWN20	CKB1	20 - 36	19	19	190	-	148	170	180
ST19-CKB1-240HM	335.322	SW20,EWN20	CKB1	20 - 36	19	19	240	-	198	220	230
ST21-CKB1-140HM	335.380	SW20,EWN20	CKB1	20 - 36	21	19	140	26	98	120	-
ST21-CKB1-190HM	335.381	SW20,EWN20	CKB1	20 - 36	21	19	190	26	148	170	-
ST21-CKB1-240HM	335.382	SW20,EWN20	CKB1	20 - 36	21	19	240	26	198	220	-
ST23-CKB1-140HM	335.383	SW20,EWN20	CKB1	20 - 36	23	19	140	26	98	120	-
ST23-CKB1-190HM	335.384	SW20,EWN20	CKB1	20 - 36	23	19	190	26	148	170	-
ST23-CKB1-240HM	335.385	SW20,EWN20	CKB1	20 - 36	23	19	240	26	198	220	-
ST24-CKB2-160HM	335.323	SW25,EWN25	CKB2	25 - 47	24	24	160	-	121	140	150
ST24-CKB2-220HM	335.324	SW25,EWN25	CKB2	25 - 47	24	24	220	-	181	200	210
ST24-CKB2-290HM	335.325	SW25,EWN25	CKB2	25 - 47	24	24	290	-	251	270	280
ST27-CKB2-160HM	335.386	SW25,EWN25	CKB2	25 - 47	27	24	160	28	121	-	-
ST27-CKB2-220HM	335.387	SW25,EWN25	CKB2	25 - 47	27	24	220	28	181	-	-
ST27-CKB2-290HM	335.388	SW25,EWN25	CKB2	25 - 47	27	24	290	28	251	-	-
ST29-CKB2-160HM	335.389	SW25,EWN25	CKB2	25 - 47	29	24	160	28	121	-	-
ST29-CKB2-220HM	335.390	SW25,EWN25	CKB2	25 - 47	29	24	220	28	181	-	-
ST29-CKB2-290HM	335.391	SW25,EWN25	CKB2	25 - 47	29	24	290	28	251	-	-
ST31-CKB3-200HM	335.326	SW32,EWN32	CKB3	32 - 60	31	31	200	-	168	-	184
ST31-CKB3-260HM	335.331	SW32,EWN32	CKB3	32 - 60	31	31	260	-	228	-	244
ST31-CKB3-350HM	335.327	SW32,EWN32	CKB3	32 - 60	31	31	350	-	318	-	334
ST40-CKB4-235HM	335.328	SW41,EWN41,EWE41	CKB4	41 - 74	40	40	235	-	207	-	-
ST40-CKB4-335HM	335.329	SW41,EWN41,EWE41	CKB4	41 - 74	40	40	335	-	307	-	-
ST40-CKB4-435HM	335.330	SW41,EWN41,EWE41	CKB4	41 - 74	40	40	435	-	407	-	-

1. X (max and min) for HMC shanks varies depending on the type (HSK, BBT, BDV, BIG CAPTO). Please contact BIG KAISER team for detailed information.

Recommended combination for Carbide Bars ST

To clamp BIG KAISER carbide bars with shank diameter \varnothing 19, 21, 23, 24, 27, 29, 31 and 40 milling chuck are highly recommended, Additional clamping possibilities are MEGA NEW Baby Chucks or Hydraulic Chucks.

Hydraulic Chuck



Hi-Power Milling Chuck



MEGA New Baby Chuck



Clamping options for carbide bars $\geq \varnothing$ 19mm

Schank	Holder	Carbide bar size	Collet
HSK-A50	MEGA25N	\varnothing 19 / \varnothing 21 / \varnothing 23 / \varnothing 24	NBC25
HSK-A63	HMC32S	\varnothing 19 / \varnothing 21 / \varnothing 23 / \varnothing 24 / \varnothing 27 / \varnothing 29	OCA32
HSK-A63	HDC31	\varnothing 31 direct clamping	
HSK-A100	HMC32	\varnothing 19 / \varnothing 24 / \varnothing 31	OCA32
HSK-A100	HMC42	\varnothing 19 / \varnothing 24 / \varnothing 31	OCA42
		\varnothing 31 / \varnothing 40	C42
BBT30	MEGA25N	\varnothing 19 / \varnothing 21 / \varnothing 23 / \varnothing 24	NBC25
BBT30	HMC32S	\varnothing 19 / \varnothing 21 / \varnothing 23 / \varnothing 24 / \varnothing 27 / \varnothing 29	OCA32
BBT40	MEGA25N	\varnothing 19 / \varnothing 21 / \varnothing 23 / \varnothing 24	NBC25
BBT40	HMC32S	\varnothing 19 / \varnothing 21 / \varnothing 23 / \varnothing 24 / \varnothing 27 / \varnothing 29	OCA32
BBT40	HDC31	\varnothing 31 direct clamping	
BBT50	MEGA25N	\varnothing 19 / \varnothing 21 / \varnothing 23 / \varnothing 24	NBC25
BBT50	HMC32S	\varnothing 19 / \varnothing 21 / \varnothing 23 / \varnothing 24 / \varnothing 27 / \varnothing 29	OCA32
BBT50	HDC19	\varnothing 19 direct clamping	
BBT50	HDC24	\varnothing 24 direct clamping	
BBT50	HDC31	\varnothing 31 direct clamping	
BBT50	HMC42	\varnothing 19 / \varnothing 24 / \varnothing 31	OCA42
		\varnothing 31 / \varnothing 40	C42
BVD40	MEGA25N	\varnothing 19 / \varnothing 21 / \varnothing 23 / \varnothing 24	NBC25
BVD40	HMC32S	\varnothing 19 / \varnothing 21 / \varnothing 23 / \varnothing 24 / \varnothing 27 / \varnothing 29	OCA32
BVD40	HDC31	\varnothing 31 direct clamping	
BVD50	MEGA25N	\varnothing 19 / \varnothing 21 / \varnothing 23 / \varnothing 24	NBC25
BVD50	HMC32S	\varnothing 19 / \varnothing 21 / \varnothing 23 / \varnothing 24 / \varnothing 27 / \varnothing 29	OCA32
BVD50	HMC42	\varnothing 19 / \varnothing 24 / \varnothing 31	OCA42
		\varnothing 31 / \varnothing 40	C42
C6	HMC32S	\varnothing 19 / \varnothing 21 / \varnothing 23 / \varnothing 24 / \varnothing 27 / \varnothing 29	OCA32
C8	HMC32S	\varnothing 19 / \varnothing 21 / \varnothing 23 / \varnothing 24 / \varnothing 27 / \varnothing 29	OCA32

Guidelines

Major Influences of Fine Boring

- The amount of stock to be removed (D.O.C.)
- Feed rate
- Cutting speed

For all of these influences, a balance must be obtained for optimal machining. Too much stock or too heavy of a feed rate will generate excessive cutting forces that can result in inconsistent bore size. When stock or feed rates are too light, the possibility of chatter increases due to deflection.

D.O.C



High Possibility for Deflection & Chatter:

When D.O.C. is less than half the insert nose radius, the resulting forces (F) are almost 100% radial.

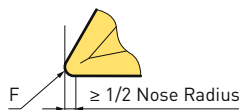

Good Stable Cut:

When D.O.C. is greater than or equal to half the insert nose radius, the resulting forces (F) are almost 100% axial.

Feed Rate

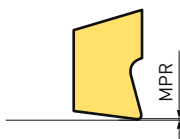

High Possibility for Deflection & Chatter:

When the feed rate is less than the hone on the insert tip, the risk of vibration increases.

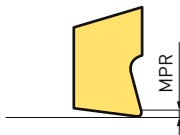

Good Stable Cut:

When the feed rate is larger than the hone on the insert tip, full use of the chip breaker is allowed. This results in lower cutting forces.

B.3

Cutting Speed

Higher Speeds:

- Better surface finish
- Shorter machining times
- Better chip evacuation

As a general rule, the tool's length/diameter ratio and insert radius will determine optimum cutting speed.

*For smaller diameter bores, carbide or heavy metal bars may be required to eliminate vibration & chatter

Lower Speeds:

- Poorer surface finish
- Low chance for chatter
- Longer machining times
- High chance for built-up edge, results in shorter insert life

L/D Ratio	Max. Insert Radius	Speed Reduction
≤ 4:1	0.8	100% of optimum
≤ 5:1	0.4	75% of optimum
≤ 6:1	0.2	60% of optimum
≥ 7:1	0.2	50% of optimum

Troubleshooting

Under certain conditions, it may be necessary to modify or adapt recommended cutting data and/or tooling configurations of the application. Below are general solutions to common problems.

Problem	Possible Cause	Remedy
Poor Tool Life	Wrong insert grade	Change to higher wear resistant grade
	Excessive speed	Reduce Vc
	Poor cooling of insert	Apply through-tool coolant
	Excessive stock allowance	Decrease depth of cut
Chatter & Vibration	Excessive speed	Reduce Vc, check cutting data tables
	Extreme length/diameter ratio	Shorten tool to increase stiffness
		Increase boring bar diameter to larger size
		Change boring bar to carbide or heavy metal
	Wrong insert	Reduce nose radius of insert Use ground geometry inserts
Incorrect stock allowance	Check cutting data tables	
Poor Size Repeatability	Inaccurate tool changes	Worn and/or damaged tool shank; replace Clean spindle and tool shank
	Variation of stock allowance	Semi-finish with rough insert boring head
	Excessive spindle looseness	Use ground geometry inserts
Unacceptable Roundness	Excessive boring tool imbalance	Change to auto-balance or balanceable head
		Balance tool assembly Reduce speed
	Excessive cutting forces	Check stock allowance and feed rate
	Insufficient workpiece clamping	Check for uniform workpiece clamping
Unacceptable Position	Original bore off position	Semi-finish with rough insert boring head
	Excessive stock allowance	Decrease depth of cut
Decrease insert radius		
Reduce cutting forces; change to ground insert		
Poor Surface Finish	Wrong insert radius	Use larger insert radius
	Excessive feed rate	Reduce feed; maximum 25% of insert radius
	Poor chip evacuation	Increase bore to boring bar clearances
		Apply through-tool coolant; adjust nozzles
		Change insert to higher rake angle Check depth of cut
Taper	Premature insert wear	Change to higher wear resistance insert grade
		Increase insert radius
		Change from ground to pressed geometry insert
		Increase coolant flow

Large Diameter Boring Tools

SERIES 318	
Overview	454
Components Ø 200 - 620	455
Rough Boring Component Selection	458
Fine Boring Component Selection	459
Accessories	460
Components Ø 620 - 3000	462
Rough and Fine Boring Component Selection Guide	463
Accessories	464

Large Diameter Boring Tools Series 318

The system is based on aluminum extension slides of different lengths, which support a variety of aluminum and steel components for roughing and finishing tool assemblies. The mounting components are pinned to fit onto specific locations on the slides, and secured with steel bolts. The precise positioning of the components on the slide along with incremental adjustment scales for insert holders permit diameter and length setting without a tool presetter.



Series 318 with Flange Only

Execution with flange only. Especially built to fit on machine tools with 40 taper spindle. For rough and fine boring, OD turning, chamfering and face grooving.
Ø 200 - 340 mm, CKB6/CKN6



Series 318 with Flange and Extension Slide

Edition with flange and extension slides. For rough and fine boring, OD turning, chamfering and face grooving.
Ø 200 - 620 mm, CKB7/CKN7



Series 318 with Bridge and Extension Slides

Edition with shanks, large bridges and extension slides. For rough and fine boring, OD turning and face grooving.
Ø 620 - 3000 mm, DV50/BT50/HSK-A100



The bridge tools of the 317 series will be removed from the BIG KAISER product range as of December 31, 2022.



The currently articles will continue to be available until the end of the year.

Series 318 with Flange Only, Ø 200 - 340



Series 318 with Flange and Extension Slide, Ø 200 - 620

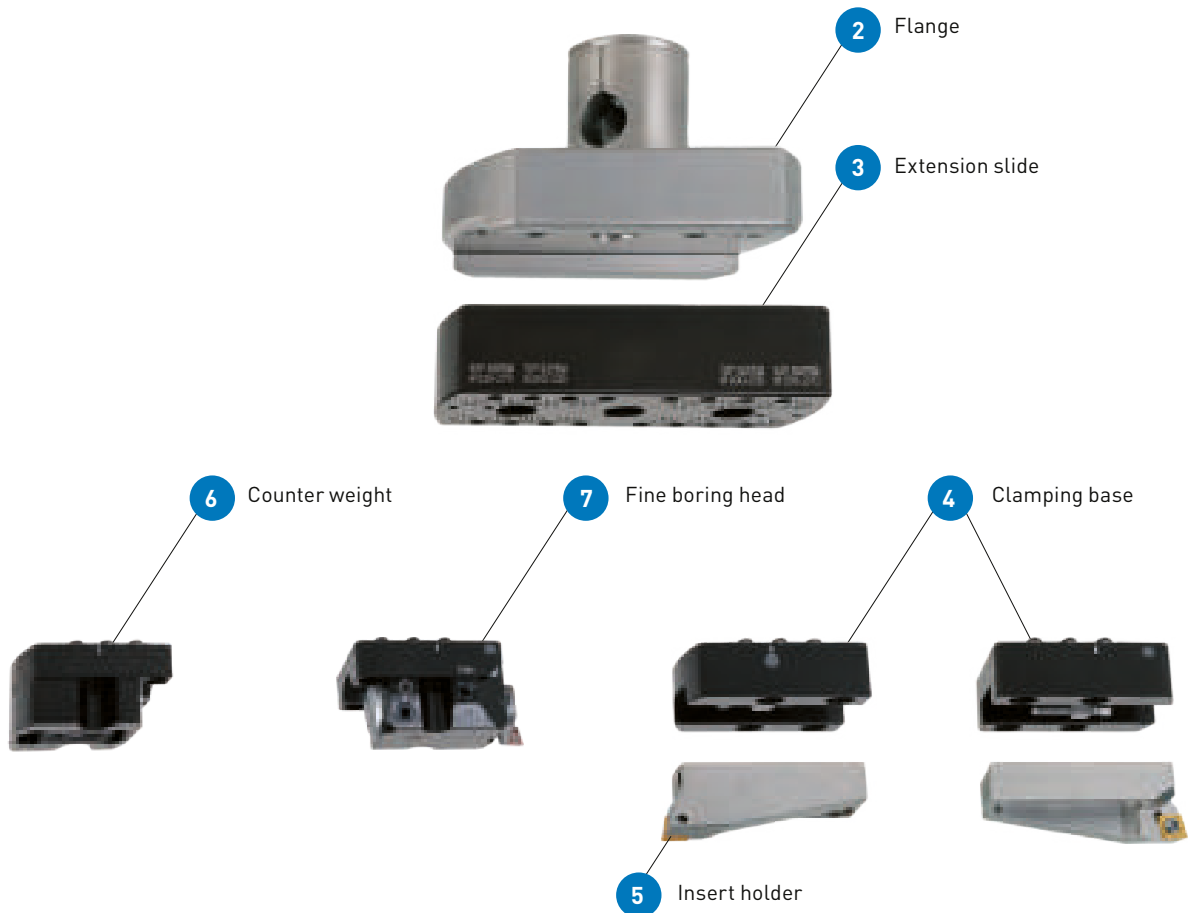

Flanges

CKB / CKN Type

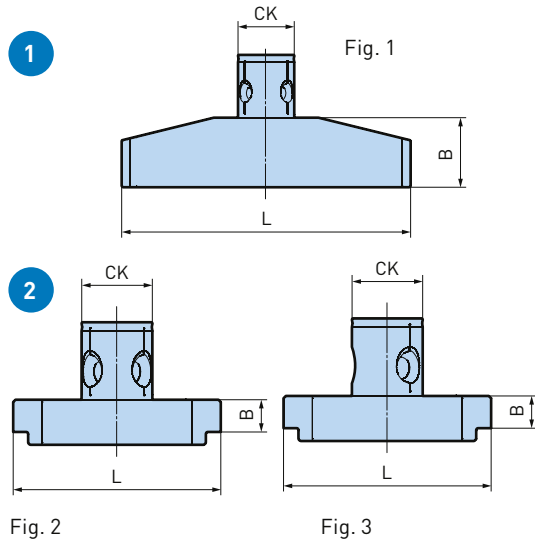

Model	Order No.	Fig.	CK	ØD	L	B
CKB6-FL200-270	318.205	1	CKB6	200 - 270	185	45
CKB6-FL270-340	318.206	1	CKB6	270 - 340	255	45
CKN6-FL200-270	318.205N	1	CKN6	200 - 270	185	45
CKN6-FL270-340	318.206N	1	CKN6	270 - 340	255	45
CKB7-FL135	318.201	2	CKB7	200 - 620	135	22
CKN7-FL135	318.201N	2	CKN7	620	135	22
CKB7-FL135-90	318.202	3	CKB7	200 - 620	135	22
CKN7-FL135-90	318.202N	3	CKN7	200 - 620	135	22

- Fig 2. Standard execution
- Fig 3. Flange with cutter position rotated 90°

BIG CAPTO Type

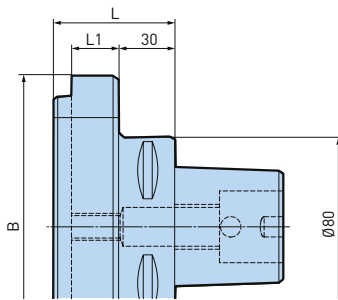

Model	Order No.	Boring Tool Series	ØD	L	B	B1
C8-FL135-317	328.086	317	200 - 620	Ø135	55	22
C8-FL135-318	328.210	318	200 - 620	Ø135	55	55
C8-FL135-317-90	328.162	317	200 - 620	Ø135	55	22
C8-FL135-318-90	328.211	318	200 - 620	Ø135	55	55

- 317 and 318 models are exclusively designed for its series. (No compatibility between 317 and 318)
- Large boring 317 series are discontinued.

Extension Slides

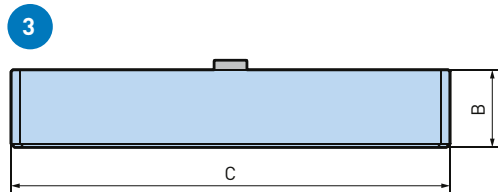

Model	Order No.	ØD	B	C	max. min-1
SLN200-270AL	318.222	200 - 270	45	185	3200
SLN270-340AL	318.223	270 - 340	45	255	2400
SLN340-410AL	318.224	340 - 410	45	325	1900
SLN410-480AL	318.225	410 - 480	45	395	1600
SLN480-550AL	318.226	480 - 550	45	465	1300
SLN550-620AL	318.227	550 - 620	45	535	1200

Clamp Bases

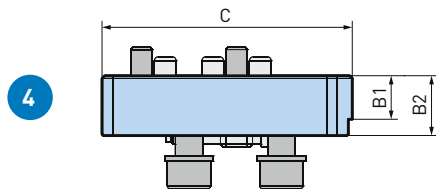

Model	Order No.	B1	B2	C
CB200	318.240	16	22	92

- Clamp bases are sold in pairs.

Insert Holders Standard Set

For ø200 - 620

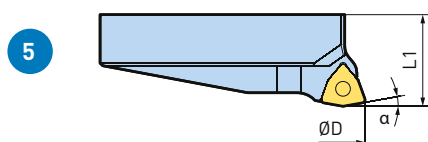

Model	Order No.	ØD	L1	α	Insert
IHTW200C	637.940	200 - 620	34	0°	CC 12
IHTW200S	637.942	200 - 620	34	6°	SC 12
IHTW200W	637.943	200 - 620	34	10°	WC 08
IHTW200C-DVS *	637.951	200 - 620	34.4	0°	CC 12
IHTW200C16	637.941	200 - 620	34	0°	CC 16
IHTW200C16-DVS *	637.953	200 - 620	34.4	0°	CC 16

- Insert holders is composed of 2 pcs. of holders.
* Step cut Insert holder are delivered individually.

EWE Fine Boring Heads, Ø 200 - 3000

6

Model	Order No.	ØD	C
EWN200AL	318.101	200 - 620	86
EWE200AL	318.104	200 - 620	86

Insert Holder Bridge Tool TC11

Model	Order No.	Fig.	ØD	α	C1	C2	E	Insert
ENH7-1T	626.271	1	200 - 3000	87°	-	-	12.5	TC 11
ENH7-2T	626.272	2	200 - 3000	87°	-	-	25	TC 11
ENH7-3T	626.273	3	200 - 3000	87°	-	-	37.5	TC 11
ENH7-1T25	689.189	4	200 - 3000	25°	-	-	12.5	TC 11
ENH7-1T30	626.472	5	200 - 3000	30°	117	108.3	12.5	TC 11
ENH7-1T45	626.473	5	200 - 3000	45°	117	109.8	12.5	TC 11

Insert Holder Bridge Tool CC09

Model	Order No.	Fig.	ØD	α	Insert
ENH7-1C	626.371	1	200 - 3000	90°	CC 09
ENH7-2C	626.372	2	200 - 3000	90°	CC 09

Insert Holder Blank Bridge Tool

Model	Order No.
ENH7-BLANK L	626.917

B.4

Counter Weight Bridge Tool

There are two different counter weights available. Type 1 is made of steel and is used for coarse balancing. Type 2 is made of aluminum and contains a slide with a graduated scale for fine balancing of the tool assembly.

7

Model	Order No.	L	C	Material
CW200AL	318.105	46	86	Aluminium
CW200	318.107	22.5	86	Steel

Fine Boring Component Selection

The table below determines the components such as extension slide (1), boring head (2), insert holder (3) and counter weight (4) for each diameter range and shows in which position the boring head and the counter weight have to be mounted on the extension slide.

Balancing of the tool combination takes place by adjusting the slide on the counter weight according to the scale. The correction value (α) is shown on the table. See example below.

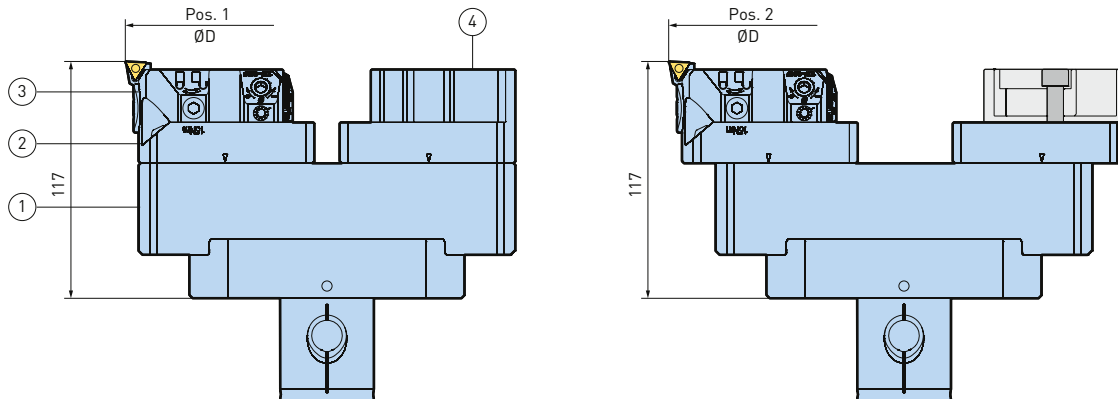

Range ØD	Extension Slide	Fixed Position/Range		Boring Head	Insert Holder	Counter Weight	Correction α		Max. Speed		
		Pos. 1/ØD	Pos. 2/ØD				Pos. 1	Pos. 2			
200 - 270	318.205N	199 - 236		318.101	626.271	318.105 (for fine balancing)	200		3 200		
	318.222		234 - 271					235			
270 - 340	318.206N	269 - 306							270		2 400
	318.223		304 - 341						305		
340 - 410	318.224	339 - 376							340		1 900
			374 - 411						375		
410 - 480	318.225	409 - 446							410		1 600
			444 - 481						445		
480 - 550	318.226	479 - 516							480		1 300
			514 - 551						515		
550 - 620	318.227	549 - 586				550		1 200			
			584 - 621			585					

B.4

Example: Diameter setting according to scale

ØD: 335 H7
 Extension slide: 318.223
 Position: 2

Counter weight: 318.105
 Correction value: 305
 Scale: $D - \alpha = 335 - 305 = 30$

OD Turning Holders, Ø 49 - 476

The tool holder with CKB5 connection can be mounted on any extension slide. For OD turning it is required to connect the fine boring head EWN53-95CKB5 either directly or by means of an extension to the holder. To compensate the imbalance, a second tool holder and a special counter weight have to be mounted on the opposite side of the extension slide.

Attention: Counter-clockwise rotation of spindle!

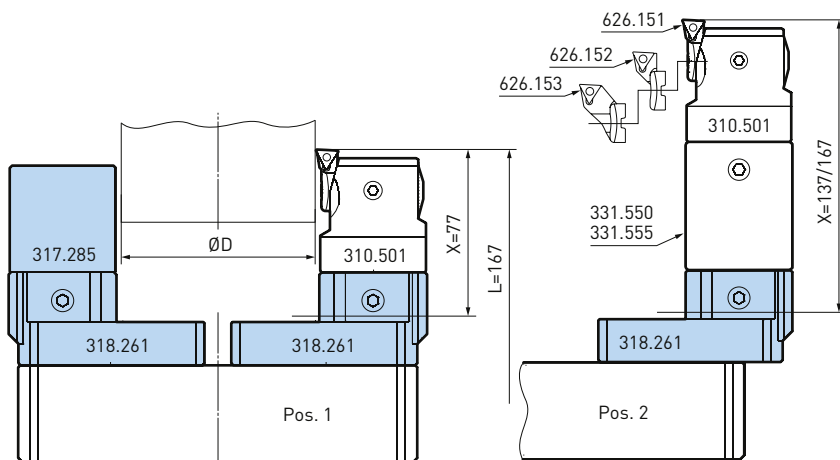

L = Distance to the CK connection.

Tool Holder

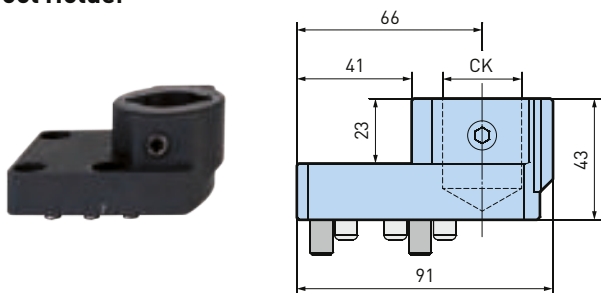

Model	Order No.	CK
CB200CKB5	318.261	CKB5

B.4

Counter Weight for OD Turning

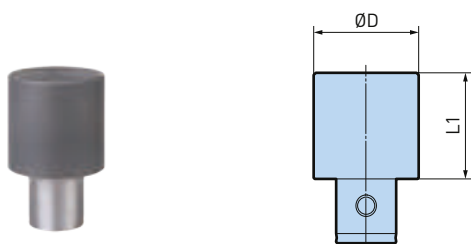

Model	Order No.	CK	ØD	L1
CW-CK5-DM49-50	317.285	CK5	49	49.5

Adjusting Table

Range ØD	Extension Slide	Pos. 1			Pos. 2		
		Range with Insert Holder No.:					
		626.153 ØD	626.152 ØD	626.151 ØD	626.153 ØD	626.152 ØD	626.151 ØD
49 - 126	318.222	49 - 66	62 - 79	74 - 91	84 - 101	97 - 114	109 - 126
119 - 196	318.223	119 - 136	132 - 149	144 - 161	154 - 171	167 - 184	179 - 196
189 - 266	318.224	189 - 206	202 - 219	214 - 231	224 - 241	237 - 254	249 - 266
259 - 336	318.225	259 - 276	272 - 289	284 - 301	294 - 311	307 - 324	319 - 336
329 - 406	318.226	329 - 346	342 - 359	354 - 371	364 - 381	377 - 394	389 - 406
399 - 476	318.227	399 - 416	412 - 429	424 - 441	434 - 451	447 - 464	459 - 476

Insert Holders for Chamfering SC12

The insert holder with step-less adjustable chamfer angle from 15-75° is made for front chamfering and with limitations also for back chamfering.

Model	Order No.
CFTW200S	637.959

ØD	Chamfer Angle α									
	15°		30°		45°		60°		75°	
	min Ø	max Ø	min Ø	max Ø	min Ø	max Ø	min Ø	max Ø	min Ø	max Ø
200 - 270	182	276	186	278	190	279	195	278	199	277
270 - 340	252	346	256	348	260	349	265	348	269	347
340 - 410	322	416	326	418	330	419	335	418	339	417
410 - 480	392	486	396	488	400	489	405	488	409	487
480 - 550	462	556	466	558	470	559	475	558	479	557
550 - 620	532	626	536	628	540	629	545	628	549	627

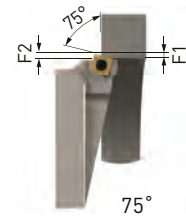
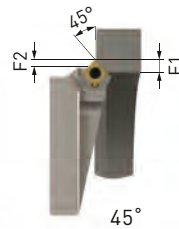
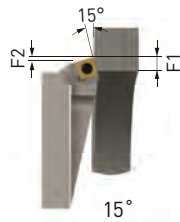

Insert Holder	Max. Radial Chamfer Length for Front and Back Chamfering									
	15°		30°		45°		60°		75°	
	F1	F2	F1	F2	F1	F2	F1	F2	F1	F2
SC12	11.4	3	10.3	4	8.4	4.2	5.9	3.9	3	3

Face Grooving Holders

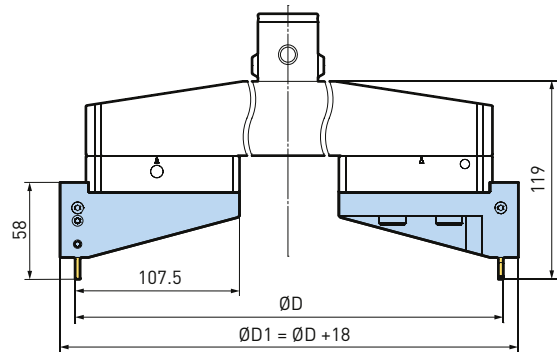

Model	Order No.	ØD
FGHTW200	637.961	198 - 3002

1. Inserts are not included.

Inserts for face grooves

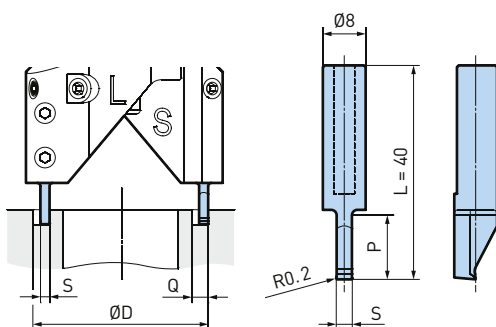

Model	Order No.	P	S	Q	Cutting material / coating
SS2-ST8-40K40	958.601	12	2	3.5	K40
SS2-ST8-40K40C	958.611	12	2	3.5	K40C
SS3-ST8-40K40	958.602	12	3	5.5	K40
SS3-ST8-40K40C	958.612	12	3	5.5	K40C
SS4-ST8-40K40	958.603	12	4	7.5	K40
SS4-ST8-40K40C	958.613	12	4	7.5	K40C
SS5-ST8-40K40	958.604	12	5	9.5	K40
SS5-ST8-40K40C	958.614	12	5	9.5	K40C

Series 318 with Bridge and Extension Slides, Ø 620 - 3000

The boring range from Ø 620 – 3 000 mm is covered with only five aluminium bridges and five pairs of extension slides. All other components such as boring head, clamp bases and insert holders are the same as for the existing light weight boring tool system Ø 200 – 620 mm.

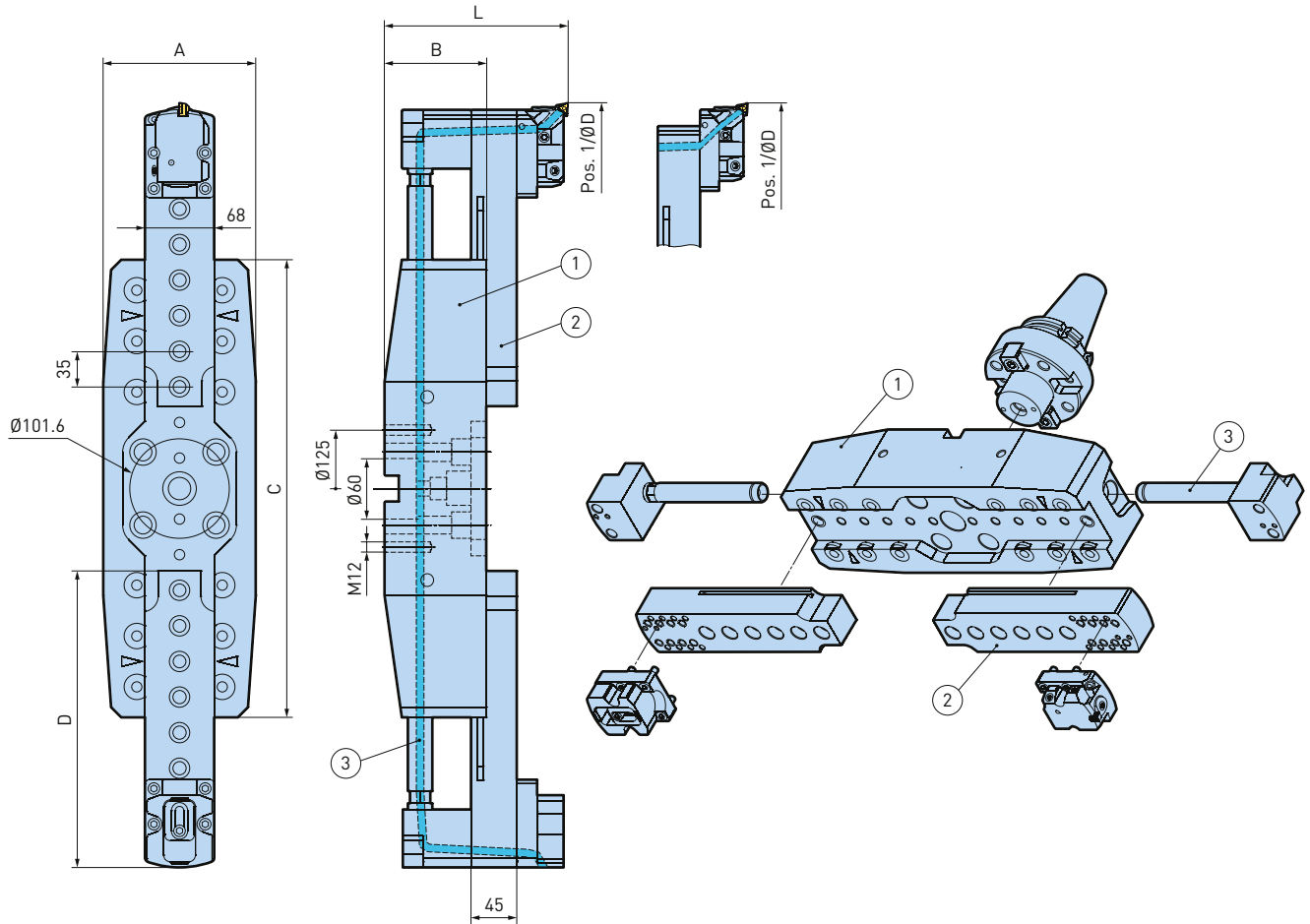

B.4

ØD	L	A	B	C	D
620 - 830	180	150	100	450	292.5
830 - 1110	180	150	100	660	397.5
1110 - 1530	180	150	100	940	537.5
1530 - 2020	200	170	120	1360	642.5
2020 - 2510	210	190	130	1850	642.5
2510 - 3000	210	190	130	1850	1167.5

Rough and Fine Boring Component Selection

The table below refers to the drawings on page 462. It determines the components such as bridge (1), extension slide (2) and coolant supply (3) for each diameter range (ØD) and shows in which position (1 or 2) the roughing or finishing tools have to be mounted.

In addition, this table also serves to determine the scale values for the coarse diameter setting of the cutting edges for finishing, and to adjust the slide on the counter weight for precise balancing of finish tools. The required scale values are calculated by the difference between bore diameter and correction value (α). See example below.

ØD	① Bridge		② * Extension Slide		Position		α		③ * Coolant Supply	
	Model	Order No.	Model	Order No.	Pos. 1/ØD	Pos. 2/ØD	Pos. 1	Pos. 2	Model	Order No.
620 - 690	BR620-830AL	318.421	SL620-830AL	318.431	619 - 656	654 - 691	620	655	CS620-1110	318.441
690 - 760					689 - 726	724 - 761	690	725		
760 - 830					759 - 796	794 - 831	760	795		
830 - 900	BR830-1110	318.422	SL830-1110	318.432	829 - 866	864 - 901	830	865	CS620-1110	318.441
900 - 970					899 - 936	934 - 971	900	935		
900 - 1040					969 - 1006	1004 - 1041	970	1005		
1040 - 1110					1039 - 1076	1074 - 1111	1040	1075		
1110 - 1180	BR1110-1530	318.423	SL1110-1530	318.433	1109 - 1146	1144 - 1181	1110	1145	CS1110-1530	318.442
1180 - 1250					1179 - 1216	1214 - 1251	1180	1215		
1250 - 1320					1249 - 1286	1284 - 1321	1250	1285		
1320 - 1390					1319 - 1356	1354 - 1391	1320	1355		
1390 - 1460					1389 - 1426	1424 - 1461	1390	1425		
1460 - 1530					1459 - 1496	1494 - 1531	1460	1495		
1530 - 1600	BR1530-2020	318.424	SL1530-2510	318.434	1529 - 1566	1564 - 1601	1530	1565	CS1530-2510	318.443
1600 - 1670					1599 - 1636	1634 - 1671	1600	1635		
1670 - 1740					1669 - 1706	1704 - 1741	1670	1705		
1740 - 1810					1739 - 1776	1774 - 1811	1740	1775		
1810 - 1880					1809 - 1846	1844 - 1881	1810	1845		
1880 - 1950					1879 - 1916	1914 - 1951	1880	1915		
1950 - 2020	BR2020-2510	318.425	SL1530-2510	318.434	1949 - 1986	1984 - 2021	1950	1985	CS1530-2510	318.443
2020 - 2090					2019 - 2056	2054 - 2091	2020	2055		
2090 - 2160					2089 - 2126	2124 - 2161	2090	2125		
2160 - 2230					2159 - 2196	2194 - 2231	2160	2195		
2230 - 2300					2229 - 2266	2264 - 2301	2230	2265		
2300 - 2370					2299 - 2336	2334 - 2371	2300	2335		
2370 - 2440	BR2020-2510	318.425	SL2510-3000	318.435	2369 - 2406	2404 - 2441	2370	2405	CS2510-3000	318.444
2440 - 2510					2439 - 2476	2474 - 2511	2440	2475		
2510 - 2580					2509 - 2546	2544 - 2581	2510	2545		
2580 - 2650					2579 - 2616	2614 - 2651	2580	2615		
2650 - 2720					2649 - 2686	2684 - 2721	2650	2685		
2720 - 2790					2719 - 2756	2754 - 2791	2720	2755		
2790 - 2860	BR2020-2510	318.425	SL2510-3000	318.435	2789 - 2826	2824 - 2861	2790	2825	CS2510-3000	318.444
2860 - 2930					2859 - 2896	2894 - 2931	2860	2895		
2930 - 3000					2929 - 2966	2964 - 3001	2930	2965		

1. * Single pieces. 2 pieces are needed for tool combination.

Example: Diameter setting according to scale

ØD: 1170 H7
 Bridge: 318.423
 Extension slide: 318.433
 Position: 2
 Counter weight: 318.105
 Coolant supply: 318.442
 Correction value α: 1145
 Scale: ØD - α = 1170 - 1145 = 25

OD Turning Holders, Ø 469 - 2856

Attention: Counter-clockwise rotation of spindle!

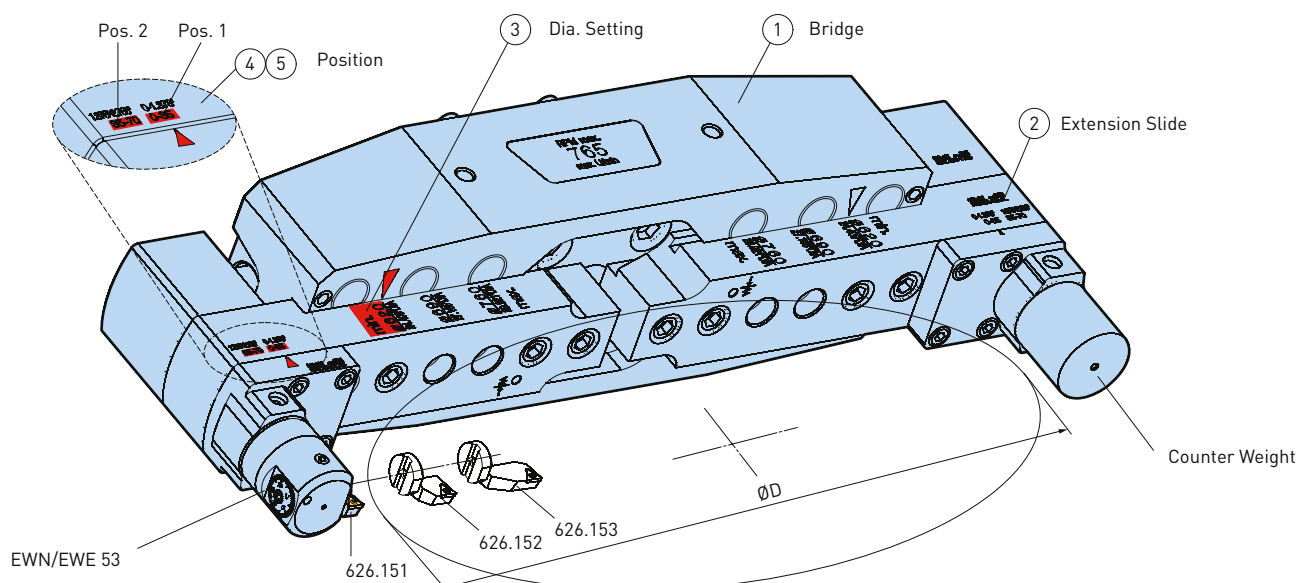

① Bridge	② Extension Slide	ØD	③ Dia. Setting	④ Pos. 1			⑤ Pos. 2		
				Range with Insert Holder Order No.:			Range with Insert Holder Order No.:		
Order No.	Order No.			626.153 ØD	626.152 ØD	626.151 ØD	626.153 ØD	626.152 ØD	626.151 ØD
318.421	318.431	469 - 546	620	469 - 486	482 - 499	494 - 511	504 - 521	517 - 534	529 - 546
		539 - 616	690	539 - 556	552 - 569	564 - 581	574 - 591	587 - 604	599 - 616
		609 - 686	760	609 - 626	622 - 639	634 - 651	644 - 661	657 - 674	669 - 686
318.422	318.432	679 - 756	830	679 - 696	692 - 709	704 - 721	714 - 731	727 - 744	739 - 756
		749 - 826	900	749 - 766	762 - 779	774 - 791	784 - 801	797 - 814	809 - 826
		819 - 896	970	819 - 836	832 - 849	844 - 861	854 - 871	867 - 884	879 - 896
		889 - 966	1040	889 - 906	902 - 919	914 - 931	924 - 941	937 - 954	949 - 966
318.423	318.433	959 - 1036	1110	959 - 976	972 - 989	984 - 1001	994 - 1011	1007 - 1024	1019 - 1036
		1029 - 1106	1180	1029 - 1046	1042 - 1059	1054 - 1071	1064 - 1081	1077 - 1094	1089 - 1106
		1099 - 1176	1250	1099 - 1116	1112 - 1129	1124 - 1141	1134 - 1151	1147 - 1164	1159 - 1176
		1169 - 1246	1320	1169 - 1186	1182 - 1199	1194 - 1211	1204 - 1221	1217 - 1234	1229 - 1246
		1239 - 1316	1390	1239 - 1256	1252 - 1269	1264 - 1281	1274 - 1291	1287 - 1304	1299 - 1316
		1309 - 1386	1460	1309 - 1326	1322 - 1339	1334 - 1351	1344 - 1361	1357 - 1374	1369 - 1386
318.424	318.434	1379 - 1456	1530	1379 - 1396	1392 - 1409	1404 - 1421	1414 - 1431	1427 - 1444	1439 - 1456
		1449 - 1526	1600	1449 - 1466	1462 - 1479	1474 - 1491	1484 - 1501	1497 - 1514	1509 - 1526
		1519 - 1596	1670	1519 - 1536	1532 - 1549	1544 - 1561	1554 - 1571	1567 - 1584	1579 - 1596
		1589 - 1666	1740	1589 - 1606	1602 - 1619	1614 - 1631	1624 - 1641	1637 - 1654	1649 - 1666
		1659 - 1736	1810	1659 - 1676	1672 - 1689	1684 - 1701	1694 - 1711	1707 - 1724	1719 - 1736
		1729 - 1806	1880	1729 - 1746	1742 - 1759	1754 - 1771	1764 - 1781	1777 - 1794	1789 - 1806
318.425	318.435	1799 - 1876	1950	1799 - 1816	1812 - 1829	1824 - 1841	1834 - 1851	1847 - 1864	1859 - 1876
		1869 - 1946	2020	1869 - 1886	1882 - 1899	1894 - 1911	1904 - 1921	1917 - 1934	1929 - 1946
		1939 - 2016	2090	1939 - 1956	1952 - 1969	1964 - 1981	1974 - 1991	1987 - 2004	1999 - 2016
		2009 - 2086	2160	2009 - 2026	2022 - 2039	2034 - 2051	2044 - 2061	2057 - 2074	2069 - 2086
		2079 - 2156	2230	2079 - 2096	2092 - 2109	2104 - 2121	2114 - 2131	2127 - 2144	2139 - 2156
		2149 - 2226	2300	2149 - 2166	2162 - 2179	2174 - 2191	2184 - 2201	2197 - 2214	2209 - 2226
		2219 - 2296	2370	2219 - 2236	2232 - 2249	2244 - 2261	2254 - 2271	2267 - 2284	2279 - 2296
318.425	318.435	2289 - 2366	2440	2289 - 2306	2302 - 2319	2314 - 2331	2324 - 2341	2337 - 2354	2349 - 2366
		2359 - 2436	2510	2359 - 2376	2372 - 2389	2384 - 2401	2394 - 2411	2407 - 2424	2419 - 2436
		2429 - 2506	2580	2429 - 2446	2442 - 2459	2454 - 2471	2464 - 2481	2477 - 2494	2489 - 2506
		2499 - 2576	2650	2499 - 2516	2512 - 2529	2524 - 2541	2534 - 2551	2547 - 2564	2559 - 2576
		2569 - 2646	2720	2569 - 2586	2582 - 2599	2594 - 2611	2604 - 2621	2617 - 2634	2629 - 2646
		2639 - 2716	2790	2639 - 2656	2652 - 2669	2664 - 2681	2674 - 2691	2687 - 2704	2699 - 2716
		2709 - 2786	2860	2709 - 2726	2722 - 2739	2734 - 2751	2744 - 2761	2757 - 2774	2769 - 2786
2779 - 2856	2930	2779 - 2796	2792 - 2809	2804 - 2821	2814 - 2831	2827 - 2844	2836 - 2856		

Shanks and Tool Holders for Bridge Tool Series 318, Ø 620 - 3000

BBT50, MAS 403/BT

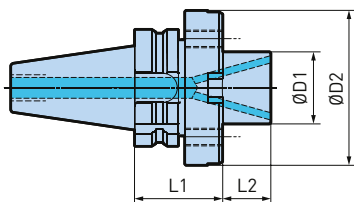

Model	Order No.	Taper Size	ØD1	ØD2	L1	L2
BBT50-F60-85	328.213	BT50	60	129	85	40

BDV50, DIN 69871 AD

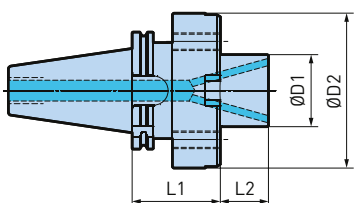

Model	Order No.	Taper Size	ØD1	ØD2	L1	L2
BDV50-F60-75	328.215	DV50	60	129	75	40

HSK-A100, DIN 69893A

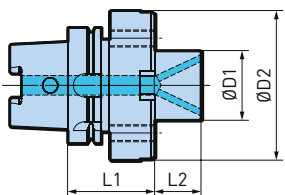

Model	Order No.	Taper Size	ØD1	ØD2	L1	L2
HSK-A100-F60-75	328.214	HSK-A100	60	129	75	40

BIG KAISER CKN

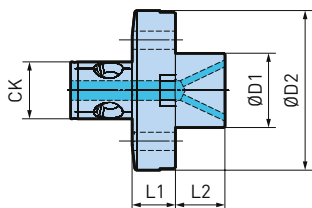

Model	Order No.	Taper Size	ØD1	ØD2	L1	L2
CKN7-F60	328.217N	CKN7	60	129	35	40

Centering Shank ISO 50

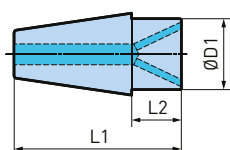

Model	Order No.	Taper Size	ØD1	ØD2	L1	L2
DV50-F60	328.216	ISO50, M24	60	129	140	40

Adapter rings and spacers available on request.

Safety Instructions

The max. speed allowed for series 318 boring tools is in relation to the boring diameter and the extension slide used. All extension slides are marked with max. speed allowed [n max.].

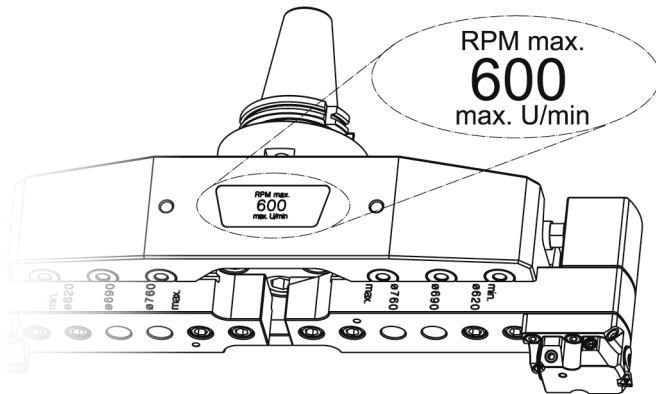

ØD	Max. Speed [min ⁻¹]	Bridge Aluminium
619 - 831	600	318.421
829 - 1111	450	318.422
1109 - 1531	350	318.423
1529 - 2021	250	318.424
2019 - 2511	190	318.425
2509 - 3001	150	318.425

Application Notes

1. Roughing

Ø 620 – 1110 mm

Up to Ø 830 mm the bridge tool can be connected to the machine spindle over a tool shank, but only on a machine with good spindle taper, good spindle bearings and with the nominal retraction force available. For the range between Ø 830 – 1110 mm, roughing is possible with the bridge bolted on to the machine spindle. If vibration occurs use just one cutting edge.

Ø > 1110 mm

Roughing is not recommended

2. Finishing

Ø 620 – 1110 mm

Finishing is possible with the bridge tool connected to the machine spindle over a tool shank, providing that the machine spindle is in good condition.

B.4

Ø > 1110 mm

The bridge tool must be bolted on to the machine spindle, either directly or if required over a special flange.

Connecting the Bridge to the Machine Spindle

The bridge tool can be connected to the machine spindle over a tool shank (Fig. 1) or it can be bolted on to the spindle face (Fig. 2). A combination of both variants is also possible. A bolted connection is recommended for bore sizes Ø 1110 mm and bigger.

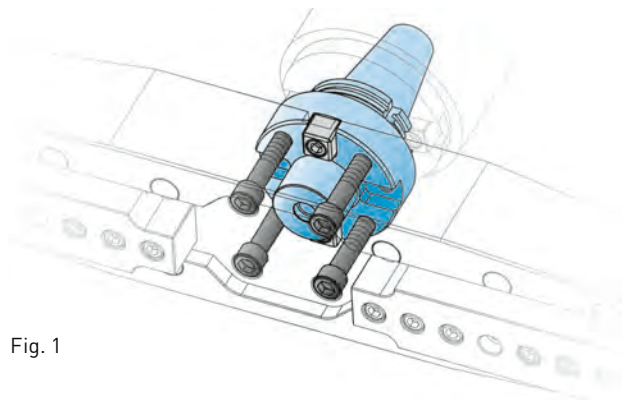

Fig. 1

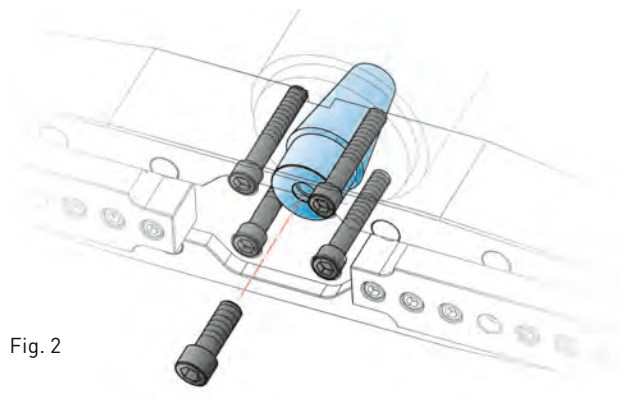

Fig. 2

Indexable Inserts and Cutters

Application Advice	468
WC-Inserts for Fine Boring Heads	470
TP-Inserts for Fine Boring Heads	471
TC-Inserts for Fine Boring Heads	472
MW/CC-Inserts for Fine and Rough Boring Heads	475
SP-Inserts for Rough Boring Heads	479
SC-Inserts for Rough Boring Heads	480
WP 337-Inserts for Indexable Insert Drills	482
WC-Inserts for Rough Boring Heads	484
TP/TC CBN/PCD-Inserts for Fine Boring Heads	488
CC CBN/PCD-Inserts for Fine and Rough Boring Heads	490
Inserts for Various Applications	492

ISO Code for inserts for boring and turning

V	B	M	T	-16	04	04	F	N	-M	P	10	H
1	2	3	4	5	6	7	8	9	10	11	12	

1	Insert Shape	2	Clearance angle	3	Tolerance class												
				Class	<table border="1"> <tr> <td>C</td> <td>± 0.025</td> <td>± 0.013</td> <td>± 0.025</td> </tr> <tr> <td>G</td> <td>± 0.025</td> <td>± 0.025</td> <td>± 0.13</td> </tr> <tr> <td>M</td> <td>± 0.05 - 0.1¹⁾</td> <td>± 0.08 - 0.20¹⁾</td> <td>± 0.13</td> </tr> </table>	C	± 0.025	± 0.013	± 0.025	G	± 0.025	± 0.025	± 0.13	M	± 0.05 - 0.1 ¹⁾	± 0.08 - 0.20 ¹⁾	± 0.13
C	± 0.025	± 0.013	± 0.025														
G	± 0.025	± 0.025	± 0.13														
M	± 0.05 - 0.1 ¹⁾	± 0.08 - 0.20 ¹⁾	± 0.13														
					1) Dependent upon insert size												

4	Chip breaker/ Mounting criteria	5	Insert size																																																																																																																																																																																																																																																
	<p>β = 40°-60°</p> <p>β = 40°-60°</p> <p>X = Special execution</p>		<table border="1"> <thead> <tr> <th>Size</th> <th>02</th> <th>03</th> <th>04</th> <th>05</th> <th>06</th> <th>07</th> <th>08</th> <th>09</th> <th>10</th> <th>11</th> <th>12</th> <th>15</th> <th>16</th> <th>19</th> <th>22</th> </tr> </thead> <tbody> <tr> <td> L</td> <td></td> <td></td> <td></td> <td></td> <td></td> <td></td> <td></td> <td></td> <td></td> <td></td> <td></td> <td></td> <td></td> <td></td> <td></td> </tr> <tr> <td> IC</td> <td></td> <td></td> <td></td> <td></td> <td></td> <td></td> <td></td> <td></td> <td></td> <td></td> <td>12.9</td> <td></td> <td>16.1</td> <td>19.3</td> <td></td> </tr> <tr> <td></td> <td></td> <td></td> <td></td> <td></td> <td></td> <td></td> <td></td> <td></td> <td></td> <td></td> <td>12.7</td> <td></td> <td>15.88</td> <td>19.05</td> <td></td> </tr> <tr> <td> L</td> <td></td> <td></td> <td></td> <td></td> <td></td> <td></td> <td></td> <td></td> <td></td> <td></td> <td></td> <td></td> <td></td> <td></td> <td></td> </tr> <tr> <td> IC</td> <td></td> <td></td> <td></td> <td></td> <td></td> <td></td> <td></td> <td></td> <td></td> <td></td> <td></td> <td>15.5</td> <td></td> <td>19.4</td> <td></td> </tr> <tr> <td></td> <td></td> <td></td> <td></td> <td></td> <td></td> <td></td> <td></td> <td></td> <td></td> <td></td> <td></td> <td>12.7</td> <td></td> <td>15.875</td> <td></td> </tr> <tr> <td> L</td> <td></td> <td></td> <td></td> <td></td> <td>6.35</td> <td></td> <td>8</td> <td>9.52</td> <td></td> <td></td> <td>12.7</td> <td></td> <td></td> <td></td> <td></td> </tr> <tr> <td> IC</td> <td></td> <td></td> <td></td> <td></td> <td>6.35</td> <td></td> <td>8.0</td> <td>9.52</td> <td></td> <td></td> <td>12.7</td> <td></td> <td></td> <td></td> <td></td> </tr> <tr> <td> L</td> <td></td> <td></td> <td></td> <td></td> <td></td> <td></td> <td></td> <td></td> <td></td> <td>11</td> <td></td> <td></td> <td>16.5</td> <td>22</td> <td></td> </tr> <tr> <td> IC</td> <td></td> <td></td> <td></td> <td></td> <td></td> <td></td> <td></td> <td></td> <td></td> <td>6.35</td> <td></td> <td></td> <td>9.525</td> <td>12.7</td> <td></td> </tr> <tr> <td> L</td> <td></td> <td></td> <td></td> <td></td> <td></td> <td></td> <td></td> <td></td> <td></td> <td></td> <td>11.1</td> <td></td> <td>16.6</td> <td>22.1</td> <td></td> </tr> <tr> <td> IC</td> <td></td> <td></td> <td></td> <td></td> <td></td> <td></td> <td></td> <td></td> <td></td> <td></td> <td>6.35</td> <td></td> <td>9.525</td> <td>12.7</td> <td></td> </tr> <tr> <td> L</td> <td>2</td> <td>3</td> <td>4</td> <td>5</td> <td>6</td> <td></td> <td>8</td> <td>10</td> <td></td> <td></td> <td></td> <td></td> <td></td> <td></td> <td></td> </tr> <tr> <td> IC</td> <td>3.97</td> <td>5.56</td> <td>6.35</td> <td>7.94</td> <td>9.52</td> <td></td> <td>12.7</td> <td>15.88</td> <td></td> <td></td> <td></td> <td></td> <td></td> <td></td> <td></td> </tr> </tbody> </table>	Size	02	03	04	05	06	07	08	09	10	11	12	15	16	19	22	L																IC											12.9		16.1	19.3													12.7		15.88	19.05		L																IC												15.5		19.4														12.7		15.875		L					6.35		8	9.52			12.7					IC					6.35		8.0	9.52			12.7					L										11			16.5	22		IC										6.35			9.525	12.7		L											11.1		16.6	22.1		IC											6.35		9.525	12.7		L	2	3	4	5	6		8	10								IC	3.97	5.56	6.35	7.94	9.52		12.7	15.88							
Size	02	03	04	05	06	07	08	09	10	11	12	15	16	19	22																																																																																																																																																																																																																																				
L																																																																																																																																																																																																																																																			
IC											12.9		16.1	19.3																																																																																																																																																																																																																																					
											12.7		15.88	19.05																																																																																																																																																																																																																																					
L																																																																																																																																																																																																																																																			
IC												15.5		19.4																																																																																																																																																																																																																																					
												12.7		15.875																																																																																																																																																																																																																																					
L					6.35		8	9.52			12.7																																																																																																																																																																																																																																								
IC					6.35		8.0	9.52			12.7																																																																																																																																																																																																																																								
L										11			16.5	22																																																																																																																																																																																																																																					
IC										6.35			9.525	12.7																																																																																																																																																																																																																																					
L											11.1		16.6	22.1																																																																																																																																																																																																																																					
IC											6.35		9.525	12.7																																																																																																																																																																																																																																					
L	2	3	4	5	6		8	10																																																																																																																																																																																																																																											
IC	3.97	5.56	6.35	7.94	9.52		12.7	15.88																																																																																																																																																																																																																																											

6	Insert thickness	7	Corner radius	8	Cutting edge																																
	<table border="1"> <tr><td>01</td><td>s = 1.59</td></tr> <tr><td>02</td><td>s = 2.38 (2.5*)</td></tr> <tr><td>03</td><td>s = 3.18 (3.0*)</td></tr> <tr><td>T3</td><td>s = 3.97</td></tr> <tr><td>04</td><td>s = 4.76</td></tr> <tr><td>05</td><td>s = 5.56</td></tr> <tr><td>06</td><td>s = 6.35</td></tr> </table> <p>*) Special size</p>	01	s = 1.59	02	s = 2.38 (2.5*)	03	s = 3.18 (3.0*)	T3	s = 3.97	04	s = 4.76	05	s = 5.56	06	s = 6.35	<table border="1"> <tr><td>01</td><td>R = 0.1</td></tr> <tr><td>02</td><td>R = 0.2</td></tr> <tr><td>03</td><td>R = 0.3</td></tr> <tr><td>04</td><td>R = 0.4</td></tr> <tr><td>06</td><td>R = 0.6</td></tr> <tr><td>08</td><td>R = 0.8</td></tr> <tr><td>10</td><td>R = 1.0</td></tr> <tr><td>12</td><td>R = 1.2</td></tr> </table>	01	R = 0.1	02	R = 0.2	03	R = 0.3	04	R = 0.4	06	R = 0.6	08	R = 0.8	10	R = 1.0	12	R = 1.2	<table border="1"> <tr><td>F</td><td>E</td></tr> <tr><td>T</td><td>S</td></tr> </table> <p>W Wiper geometry</p>	F	E	T	S
01	s = 1.59																																				
02	s = 2.38 (2.5*)																																				
03	s = 3.18 (3.0*)																																				
T3	s = 3.97																																				
04	s = 4.76																																				
05	s = 5.56																																				
06	s = 6.35																																				
01	R = 0.1																																				
02	R = 0.2																																				
03	R = 0.3																																				
04	R = 0.4																																				
06	R = 0.6																																				
08	R = 0.8																																				
10	R = 1.0																																				
12	R = 1.2																																				
F	E																																				
T	S																																				

= less suitable
 + = suitable
 ++ = first choice

ISO Code for inserts for boring and turning

V	B	M	T	-	16	04	04	F	N	-	M	P	10	H
1	2	3	4		5	6	7	8	9		10	11	12	

9	Cutting direction	10	Processing
		F = Finishing M = Medium R = Roughing	

11	Cutting Materials	12	Features
ISO main groups	Work piece materials	ISO application groups	H = uncoated carbide C = coated carbide CT = cermet CTC = silicon nitride SN = polycrystalline cubic boron nitride CBN = nitride PKD = polycrystalline diamond
P	Carbon steels Cast steel	P10 P20 P30 P40 P50	
M	Stainless steels	M10 M20 M30 M40	
K	Cast iron	K10 K20 K30	
N	Aluminium Non-ferrous metals Synthetic materials	N10	
H	Hardened materials	H10 H20	
S	Titanium NiCo Alloys High temperature alloys	S10 S20	

Features

Uncoated carbide H

Uncoated hard metal cutting materials are based on tungsten carbide with the addition of titanium carbide, tantalum carbide and cobalt as binding agents. Depending on the allotted ISO group, they are suitable for rough machining and finishing of metallic and non-metallic materials.

Coated carbide C

Coated hard metal is characterised by its high resistance to wear, its low friction coefficient and minimal built-up edge formation. The multiple coating is a good precondition for cost-effective production machining of all commonly available materials.

Cermet CT

Cermet cutting materials consist of titanium carbide and titanium nitride. They are characterised by high thermal and abrasion resistance and are suitable for finish machining and light rough-machining of steel, cast iron and light metal at high cutting speeds.

Silicon nitride SN

Ceramic cutting edges are extremely temperature-stable, highly impact-resistant and accommodate the highest cutting speeds when machining cast iron in continuous as well as in interrupted cutting.

Polycrystalline cubic boron nitride CBN

CBN cutting materials feature an extremely high wear and heat resistance. Depending on the design, CBN cutting edges are suitable for boring hardened steel, up to 70 HRC, hard cast steel, cast iron and hard nickel alloys.

Polycrystalline diamond PCD

PCD cutting edges are extremely hard and abrasion-resistant. They permit high speed finish machining of non-ferrous materials and composites.

Inserts WC

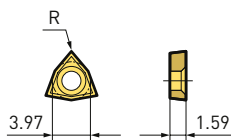

WC..0201 chip-breakers pressed



Insert Shape	Model	Order No.	Radius [mm]	Rake Angle γ	Cutting material / coating	Construction Steels	Heat Treatable Steels	Stainless Steels	Cast Iron GG	Cast Iron GGG	AL / Non-Ferrous Metals	Hardened Steel ≤ 56 HRC	NiCo Legierungen Titan	High Volume Machining	Unfavorable Conditions	Slightly Interrupted Cut	Heavily Interrupted Cut	HSC	
	WCGT-020102FN-MP10CT	655.600	0.2	15°		+	+			+				+					

WC..0201 chip-breakers ground or pressed & polished

	WCGT-020101FL-FK10C	655.605	0.1	23°	TiAlN	+	+	+	++	++	+	+	+		++				
	WCGT-020102FL-FK10C	655.603	0.2	23°	TiAlN	+	+	+	++	++	+	+	+	++	+	+			
	WCGT-020101FL-FK10CT	655.604	0.1	23°							++				++	+			
	WCGT-020102FL-FK10CT	655.601	0.2	23°							++			++		+			
	WCGT-020101FL-FM10C	655.606	0.1	23°	AlCrN	++	++	++	+	+	+	+	+	+	++				
	WCGT-020102FL-FM10C	655.602	0.2	23°	AlCrN	++	++	++	+	+	+	++	++	++	++	+	+		

B.5

Accessories & Spare Parts

<p>Torx SET</p>  <p>► 515</p>	<p>Insert Clamping Screw</p>  <p>► 514</p>
--	---

1. γ Rake angle with insert on tool.
2. Inserts are sold in packages of 10 pieces.
3. The clamping screws for the inserts are supplied in packages of 10 pieces with a corresponding wrench.

= less suitable
+ = suitable
++ = first choice

Inserts TP

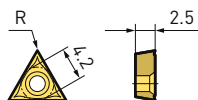

TP..0702 chip-breakers pressed

Insert Shape	Model	Order No.	Radius [mm]	Rake Angle γ	Cutting material / coating	Construction Steels	Heat Treatable Steels	Stainless Steels	Cast Iron GG	Cast Iron GGG	AL / Non-Ferrous Metals	Hardened Steel ≤ 56 HRC	NiCo Legierungen Titan	High Volume Machining	Unfavorable Conditions	Slightly Interrupted Cut	Heavily Interrupted Cut	HSC
	TPGT-070202FN-MP10CT	651.802	0.2	15°		++	++			+				++				
	TPMT-070202FN-MP10CT	651.813	0.4	15°	AlCrN	++	++	+	+	+				++		+		
	TPGT-070204FN-MP10CT	651.702	0.4	15°		++	++			+				++				
	TPMT-070204FN-MP10CT	651.713	0.2	15°	AlCrN	++	++	+	+	+	+			++		+		

TP..0702 chip-breakers ground or pressed & polished

	TPGT-070201FL-FK10C	651.824	0.1	25°	TiAlN	+	+	+	+	+	+		+		++				
	TPGT-070203FL-FK10C	651.735	0.3	25°	TiAlN	++	++	+	++	++	+	++	+	++		+			
	TPGT-070201FL-FK10H	651.823	0.1	25°							++				++				
	TPGT-070202FL-FK10H	651.825	0.2	25°							++			++	++			++	
	TPGT-070203FL-FK10H	651.723	0.3	25°							++			++		++	+		
	TPGT-070204FL-FK10H	651.725	0.4	25°							++			++				++	
	TPGT-070202FL-FM10C	651.837	0.2	25°	AlCrN	++	++	++	+	+	+	++	++	+	++				
	TPGT-070203FL-FM10C	651.737	0.3	25°	AlCrN	++	++	++	+	+	+	++	++	++		+			
	TPGT-070201FL-FM20C	651.840	0.1	23°	AlCrN	+	++	++	++	++	+	++	++	++	+	+	+		
	TPGT-070202FL-FM20C	651.841	0.2	23°	AlCrN	+	++	++	++	++	+	++	++	++	+	+	+		
	TPGT-070203FL-FM20C	651.842	0.3	23°	AlCrN	+	++	++	++	++	+	++	++	++	+	+	+		
	TPGT-070204FL-FM20C	651.843	0.4	23°	AlCrN	+	++	++	++	++	+	++	++	++	+	+	+		
	TPGT-070202FL-FP10C	651.833	0.2	15°	TiAlN	+	+	+	+	+		+	+	+	++	+			
	TPGT-070202FL-FP10CT	651.835	0.2	18°		++	++			+	+				++				
	TPGT-070202FL-FP10CTC	651.838	0.2	18°	TiAlN	++	++	+	+	+	+	+		+	++				
	TPGT-070203FL-FP10CTC	651.738	0.3	18°	TiAlN	++	++	+	+	+	+	+		++		+			
	TPGT-070202FL-FS10C	651.839	0.2	15°	TiAlN			+					++	++	+	++	+		
	TPGT-070202FL-MP10C	651.834	0.2	20°	TiAlN	+	+	+	+	+		++	+	+	++	+			
	TPGT-070204FL-MP10C	651.734	0.4	20°	TiAlN	++	++	+	++	++		++	+	++		+			
	TPGT-070203FL-MP10CT	651.736	0.3	18°		++	++			+	+			++					

B.5

TP..0702 without chip-breakers

	TPGW-070203FN-MK10C	651.632	0.3	5°	TiAlN	+	+	+	++	+		++		++			+	
	TPGW-070203FN-MK10H	651.623	0.3	5°					+			+					+	

Accessories & Spare Parts

<p>Torx SET</p> <p>► 515</p>	<p>Insert Clamping Screw</p> <p>► 514</p>
------------------------------	---

1. γ Rake angle with insert on tool.
2. Inserts are sold in packages of 10 pieces.
3. The clamping screws for the inserts are supplied in packages of 10 pieces with a corresponding wrench.

= less suitable
 + = suitable
 ++ = first choice

Inserts TC

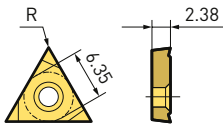

TC..1102 chip-breakers pressed

Insert Shape	Model	Order No.	Radius [mm]	Rake Angle γ	Cutting material / coating	Construction Steels	Heat Treatable Steels	Stainless Steels	Cast Iron GG	Cast Iron GGG	AL / Non-Ferrous Metals	Hardened Steel ≤ 56 HRC	NiCo Legierungen Titan	High Volume Machining	Unfavorable Conditions	Slightly Interrupted Cut	Heavily Interrupted Cut	HSC	
	TCMT-110204FN-FP10CT	655.322A	0.4	15°		++	++			+				++		+			
	TCGT-110202FL-FS20C	689.517	0.2	30°	TiN ALOX SN2			++					++						
	TCGT-110204FL-FS20C	689.516	0.4	30°	TiN ALOX SN2			++					++						
	TCGT-110208FL-FS20C	689.518	0.8	30°	TiN ALOX SN2			++					++						
	TCGT-110202FN-MK10C	655.301B	0.2	12°	TiCN-Al2O3	++	++	++	+	+		++		+	+	+			
	TCGT-110204FN-MK10C	655.302B	0.4	12°	TiCN-Al2O3	++	++	++	+	+		++		+		+	+		
	TCGT-110208FN-MK10C	655.303B	0.8	12°	TiCN-Al2O3	++	++	++	+	+		++		+		+	++		
	TCMT-110204FN-MM30C	655.354	0.4	20°	TiAIN+ Al2O3	++	++	++	+	+			++	++	++	++	++	++	
	TCGT-110208FN-MM30C	655.314	0.8	15°	TiCN- Al2O3TiN	+	+	++	+	+		+		++		++	++	++	
	TCMT-110208FN-MM30C	655.364	0.8	20°	TiAIN+ Al2O3	++	++	++	+	+			++	++	+	++	++	++	
	TCGT-110202FN-MP10CT	655.313	0.2	15°		++	++								++				
	TCMT-110204FN-MP10CT	655.322	0.4	15°		++	++			+				++		+			
	TCMT-110204FN-MP10CTC	655.324	0.4	15°	TiAIN	++	++	+	+	+	+			++		+			
	TCMT-110208FN-MP10CTC	655.334	0.8	15°	TiAIN	++	++	+	+	+	+			++		+			
	TCMT-110202FN-MP20C	655.311A	0.2	15°	Al2O3-TiCN	+	+								+	+	+		
	TCMT-110204FN-MP20C	655.321A	0.4	15°	Al2O3-TiCN	+	+								+		++	+	
	TCMT-110208FN-MP20C	655.331A	0.8	15°	Al2O3-TiCN	+	+								++		++	+	
TCMT-110202FN-MS10C	655.316	0.2	15°	TiAIN			+	+				++	++	+	++	+			
TCMT-110204FN-MS10C	655.326	0.4	15°	TiAIN			+	+				++	++	+	++	+			

B.5

TC..1102 without chip-breakers

	TCGX-110204WL-FK10C	655.306	0.8	0°				+									++	
	TCGW-110204-K10C	655.302A	0.4	0°	TiCN-Al2O3-TiN			++	++				++					
	TCGW-110202FN-MK10C	655.301A	0.2	0°	TiCN-Al2O3-TiN			++	++				++					
	TCGW-110208FN-MK10C	655.303A	0.8	0°	TiCN-Al2O3-TiN			++	++				++					
	TCGW-110204FN-MK10H	655.305	0.4	0°				+										++

Accessories & Spare Parts

<p>Torx SET</p> <p>► 515</p>	<p>Insert Clamping Screw</p> <p>► 514</p>
------------------------------	---

1. γ Rake angle with insert on tool.
2. Inserts are sold in packages of 10 pieces.
3. The clamping screws for the inserts are supplied in packages of 10 pieces with a corresponding wrench.

= less suitable
+ = suitable
++ = first choice

Inserts TC

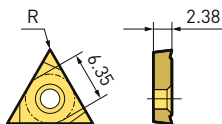



TC..1102 chip-breakers ground or pressed & polished

Insert Shape	Model	Order No.	Radius [mm]	Rake Angle γ	Cutting material / coating	Construction Steels	Heat Treatable Steels	Stainless Steels	Cast Iron GG	Cast Iron GGG	AL / Non-Ferrous Metals	Hardened Steel ≤56 HRC	NiCo Legierungen Titan	High Volume Machining	Unfavorable Conditions	Slightly Interrupted Cut	Heavily Interrupted Cut	HSC	
	TCGT-110201FL-FK10C	655.363	0.1	23°	TiAlN	+	+	+	+	+	+			++					
	TCGT-110202FL-FK10C	655.373	0.2	23°	TiAlN	+	+	+	+	+	+			+					
	TCGT-110204FL-FK10C	655.383	0.4	23°	TiAlN	++	++	+	++	++	+	++	+	++		+			
	TCGT-110208FL-FK10C	655.393	0.8	23°	TiAlN	++	++	+	++	++	+	++	+	++		+			
	TCGT-110202FL-FK10H	655.378	0.2	23°							++			+	++				
	TCGT-110204FL-FK10H	655.388	0.4	23°							++			++	+	+			
	TCGT-110208FL-FK10H	655.398	0.8	23°							++			++		+			
	TCGT-110202FL-FK20C	655.370	0.2	10°	TiAlN	++	++	+	++	++	+	++		+	++	++	+		
	TCGT-110204FL-FK20C	655.380	0.4	10°	TiAlN	++	++	+	++	++	+	++		++		++	++		
	TCGT-110208FL-FK20C	655.390	0.8	10°	TiAlN	++	++	+	++	++	+	++		++		++	++		
	TCGT-110204FL-FK20H	655.387	0.4	20°							++			++	+				++
	TCGT-110208FL-FK20H	655.397	0.8	20°							++			++					++
	TCGT-110201FL-FM10C	655.369	0.1	23°	AlCrN	++	+	++	+	+	+	++	+	+	++				
	TCGT-110202FL-FM10C	655.379	0.2	23°	AlCrN	++	+	++	+	+	+	++	+	+	++				
	TCGT-110204FL-FM10C	655.389	0.4	23°	AlCrN	++	+	++	+	+	+	++	+	++	+	+			
	TCGT-110208FL-FM10C	655.399	0.8	23°	AlCrN	++	+	++	+	+	+	++	+	++		++	+		
	TCGT-110202FL-FM20C	655.319	0.2	23°	AlCrN	+	++	++	++	++	+	++	++	++	++	+	++	+	
	TCGT-110203FL-FM20C	655.327	0.3	23°	AlCrN	+	++	++	++	++	+	++	++	++	++	+	++	+	
	TCGT-110204FL-FM20C	655.318	0.4	23°	AlCrN	+	++	++	++	++	+	++	++	++	++	+	++	+	
	TCGT-110206FL-FM20C	655.328	0.6	23°	AlCrN	+	++	++	++	++	+	++	++	++	++	+	++	+	
	TCGT-110208FL-FM20C	655.320	0.8	23°	AlCrN	+	++	++	++	++	+	++	++	++	++	+	++	+	
	TCGT-110202FL-FP10C	655.371	0.2	15°	TiAlN	+	+		+	+		+			++				
	TCGT-110204FL-FP10C	655.381	0.4	18°	TiAlN	+	+	+	+	+	+	+	+				+		
	TCGT-110202FN-FP10CT	655.372	0.2	20°		+	+								++				
	TCGT-110204FL-FP10CT	655.386	0.4	18°		++	++			+	+			++					
	TCGT-110202FL-FP10CTC	655.375	0.2	15°	TiAlN	++	++	+	+	+	+	+		+	++				
	TCGT-110204FL-FP10CTC	655.385	0.4	18°	TiAlN	++	++	+	+	+	+	+		++	+				
	TCGT-110208FL-FP10CTC	655.395	0.8	18°	TiAlN	++	++	+	+	+	+	+		++					

B.5

Accessories & Spare Parts

<p>Torx SET</p>  <p>► 515</p>	<p>Insert Clamping Screw</p>  <p>► 514</p>
--	---

1. γ Rake angle with insert on tool.
2. Inserts are sold in packages of 10 pieces.
3. The clamping screws for the inserts are supplied in packages of 10 pieces with a corresponding wrench.

= less suitable
 + = suitable
 ++ = first choice

Inserts TC

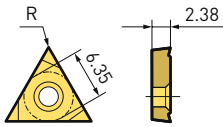

TC..1102 chip-breakers Wiper

Insert Shape	Model	Order No.	Radius [mm]	Rake Angle γ	Cutting material / coating	Construction Steels	Heat Treatable Steels	Stainless Steels	Cast Iron GG	Cast Iron GGG	AL / Non-Ferrous Metals	Hardened Steel ≤ 56 HRC	NiCo Legierungen Titan	High Volume Machining	Unfavorable Conditions	Slightly Interrupted Cut	Heavily Interrupted Cut	HSC
	TCGX-110204WL-FK10C	655.310	0.4	20°	AlCrN	++	++	++	++	+	+	+	+	++		+	+	++
	TCGX-110204WL-FK10H	655.317	0.4	20°							++		++	++		+	+	++
	TCGX-110204WL-FK20C	655.374	0.4	15°	PVD Oxid	++	++	+	+	+				++			++	
	TCGX-110204WL-FP10CT	655.315	0.4	20°		++	++			+	+	+		++		+	+	++
	TCGX-110204WL-FP10CT	655.384	0.4	15°		++	++			+	+			++				

Wiper geometry

Comparison with standard nose radius 0.4 mm

Wiper: Two times the feed rate → Same surface finish
 Same feed rate → Two times better surface finish

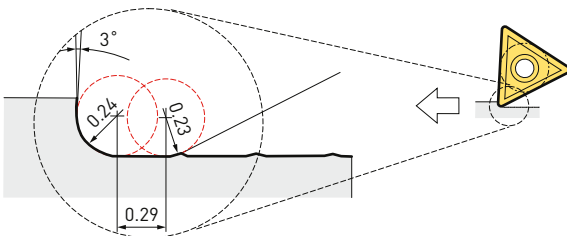

B.5

Accessories & Spare Parts

<p>Torx SET</p> <p>► 515</p>	<p>Insert Clamping Screw</p> <p>► 514</p>
------------------------------	---

1. γ Rake angle with insert on tool.
2. Inserts are sold in packages of 10 pieces.
3. The clamping screws for the inserts are supplied in packages of 10 pieces with a corresponding wrench.

= less suitable
 + = suitable
 ++ = first choice

Inserts MW

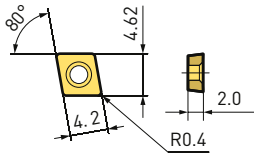

MW..0404 chip-breakers pressed

Insert Shape	Model	Order No.	Radius [mm]	Rake Angle γ	Cutting material / coating	Construction Steels	Heat Treatable Steels	Stainless Steels	Cast Iron GG	Cast Iron GGG	AL / Non-Ferrous Metals	Hardened Steel ≤56 HRC	NiCo Legierungen Titan	High Volume Machining	Unfavorable Conditions	Slightly Interrupted Cut	Heavily Interrupted Cut	HSC
	MW0404-D15N	655.940	0.4		DLC						++			++	+	+		
	MW0404-Z30K	655.941	0.4		TiAlN-AlCrN				++	++				++	+	+		
	MW0404-Z30P	655.942	0.4		TiAlN-AlCrN	+	++	++						++	+	+		

Inserts CC

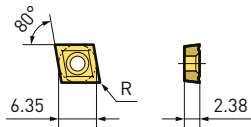

CC..0602 chip-breakers pressed

	CCMT-060204FN-RK20C	654.852	0.4	15°	Al2O3-TiN	+	+	+	++	++		+	+	++		+			
	CCMT-060204FN-RK20H	654.858	0.4	15°						+	+						+		
	CCMT-060204FN-RP20C	654.850A	0.4	15°	Al2O3-TiN	++	++	+	+	+		+	+	++					
	CCMT-060202FN-RP30C	654.840A	0.2	15°	Al2O3-TiN	+	+	+	+	+			+		+				
	CCMT-060204FN-RP30C	654.851A	0.4	15°	TiAlN	++	++	+	++	++		+	+	++		+			
	CCMT-060208FN-RP30C	654.853	0.8	15°	TiAlN	++	++	+	++	++		+	+	++	+	+	+	+	
	CCMT-060202FN-RP35C	654.846	0.2	15°	Al2O3-TiN	++	++	++	+	+		+	+	++		++	++		
	CCMT-060204FN-RP35C	654.856	0.4	15°	Al2O3-TiN	++	++	+	+	+		+	+	++		++	++		
	CCGT-060202FN-RS10C	654.837	0.2	8°	TiAlN				++					++	++	++	+		
	CCGT-060204FN-RS10C	654.847	0.4	8°	TiAlN				++					++	++	+	+		

B.5

CC..0602 chip-breakers ground

	CCMT-060202FL-RK10H	654.877	0.2	23°							++			++	+	+		
	CCMT-060204FL-RK10H	654.888	0.4	23°							++		+	++		+		
	CCMT-060202FL-RN10C	654.879	0.2	23°	AlCrN						++		+	++	+	+		
	CCMT-060204FL-RN10C	654.889	0.4	23°	AlCrN						++		+	++		+		

Accessories & Spare Parts

<p>Torx SET</p> <p>► 515</p>	<p>Insert Clamping Screw</p> <p>► 514</p>
------------------------------	---

- γ Rake angle with insert on tool.
- Inserts are sold in packages of 10 pieces.
- The clamping screws for the inserts are supplied in packages of 10 pieces with a corresponding wrench.

= less suitable
 + = suitable
 ++ = first choice

Inserts CC

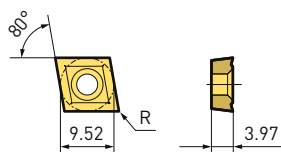

CC..09T3 chip-breakers pressed

Insert Shape	Model	Order No.	Radius [mm]	Rake Angle γ	Cutting material / coating	Construction Steels	Heat Treatable Steels	Stainless Steels	Cast Iron GG	Cast Iron GGG	AL / Non-Ferrous Metals	Hardened Steel ≤ 56 HRC	NiCo Legierungen Titan	High Volume Machining	Unfavorable Conditions	Slightly Interrupted Cut	Heavily Interrupted Cut	HSC	
	CCMT-09T304FN-RK20C	654.942	0.4	15°	Al2O3-TiN				++	++			+	++		+			
	CCMT-09T308FN-RK20C	654.952	0.8	15°	Al2O3-TiN				++	++			+	++		+			
	CCMT-09T304FN-RP20C	654.940A	0.4	15°	Al2O3-TiN	++	++	+	+	+		+	+	++		+			
	CCMT-09T302FN-RP30C	654.930A	0.2	15°	Al2O3-TiN	+	+	+	+	+					+				
	CCMT-09T308FN-RP30C	654.950	0.8	15°	Al2O3-TiN	++	++	+	+	+		+	+	++		++	+		
	CCMT-09T302FN-RP35C	654.935	0.2	15°	Al2O3-TiN	++	++	++	+	+		+	+	+	++	++	+		
	CCMT-09T304FN-RP35C	654.945	0.4	15°	Al2O3-TiN	++	++	++	+	+		+	+	++		++	++		
	CCMT-09T308FN-RP35C	654.955	0.8	15°	Al2O3-TiN	++	++	++	+	+		+	+	++		++	++		
	CCGT-09T302FN-RS10C	654.937	0.2	8°	TiAlN			++						++	++	++	+		
	CCGT-09T304FN-RS10C	654.947	0.4	8°	TiAlN			++						++	++	+	+		
	CCGT-09T308FN-RS10C	654.957	0.8	8°	TiAlN			++						++	++	+	+		

CC..09T3 chip-breakers ground

	CCMT-09T304FL-MK10H	654.977	0.4	23°							++			++	+	+		
	CCMT-09T308FL-MK10H	654.987	0.8	23°							++			++		+		
	CCMT-09T304FL-MN10C	654.949	0.4	23°	AlCrN						++		+	++	+	+		
	CCMT-09T308FL-MN10C	654.959	0.8	23°	AlCrN						++		+	++		+		

Accessories & Spare Parts

<p>Torx SET</p> <p>► 515</p>	<p>Insert Clamping Screw</p> <p>► 514</p>
------------------------------	---

- γ Rake angle with insert on tool.
- Inserts are sold in packages of 10 pieces.
- The clamping screws for the inserts are supplied in packages of 10 pieces with a corresponding wrench.

= less suitable
 + = suitable
 ++ = first choice

Inserts CC

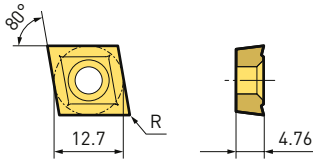

CC..1204 chip-breakers pressed



Insert Shape	Model	Order No.	Radius [mm]	Rake Angle γ	Cutting material / coating	Construction Steels	Heat Treatable Steels	Stainless Steels	Cast Iron GG	Cast Iron GGG	AL / Non-Ferrous Metals	Hardened Steel ≤56 HRC	NiCo Legierungen Titan	High Volume Machining	Unfavorable Conditions	Slightly Interrupted Cut	Heavily Interrupted Cut	HSC	
	CCMT-120404FN-RK20C	654.989	0.4	15°	TiAlN				++	++			+	++		+			
	CCMT-120408FN-RK20C	654.991	0.8	15°	TiAlN				++	++			+	++		+			
	CCMT-120408FN-RP20C	654.990A	0.8	15°	Al2O3-TiN	++	++	+	+	+		+	+	++		+			
	CCMT-120404FN-RP30C	654.993A	0.4	15°	Al2O3-TiN	+	+	+	+	+					+				
	CCMT-120408FN-RP30C	654.988	0.8	15°	Al2O3-TiN	++	++	+	+	+		+	+	++		++	+		
	CCMT-120404FN-RP35C	654.964	0.4	15°	Al2O3-TiN	++	++	++	+	+		+	+	++	++	++	++	++	
	CCMT-120408FN-RP35C	654.965	0.8	15°	Al2O3-TiN	++	++	++	+	+		+	+	++	++	++	++	++	
	CCMT-120404FN-RS10C	654.968	0.4	8°	TiAlN			++						++	++		+		
	CCMT-120408FN-RS10C	654.969	0.8	8°	TiAlN			++						++	++		+		

CC..1204 chip-breakers ground

	CCMT-120404FL-MK10H	654.995	0.4	23°							++			++	+	+		
	CCMT-120408FL-MK10H	654.992	0.8	23°							++			++	+	+		
	CCMT-120404FL-MN10C	654.978	0.4	23°	AlCrN						++		++	++	+	+	+	
	CCMT-120408FL-MN10C	654.979	0.8	23°	AlCrN						++		++	++		+	+	

B.5

Accessories & Spare Parts

<p>Torx SET</p>  <p>► 515</p>	<p>Insert Clamping Screw</p>  <p>► 514</p>
--	---

1. Inserts are sold in packages of 10 pieces.
2. The clamping screws for the inserts are supplied in packages of 10 pieces with a corresponding wrench.

= less suitable
 + = suitable
 ++ = first choice

Inserts CC

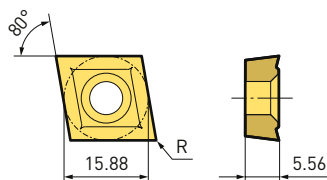



CC..1605 chip-breakers pressed

Insert Shape	Model	Order No.	Radius [mm]	Rake Angle γ	Cutting material / coating	Construction Steels	Heat Treatable Steels	Stainless Steels	Cast Iron GG	Cast Iron GGG	AL / Non-Ferrous Metals	Hardened Steel ≤ 56 HRC	NiCo Legierungen Titan	High Volume Machining	Unfavorable Conditions	Slightly Interrupted Cut	Heavily Interrupted Cut	HSC
	CCMT-160508FN-RK10H	654.997	0.8	15°					+	+			+			+		
	CCMT-160508FN-RK20C	654.983	0.8	15°	Al2O3-TiN				++	++			+	++			+	
	CCMT-160508FN-RP30C	654.996	0.8	15°	Al2O3-TiN	++	++	+	+	+		+	+	++		++	+	
	CCMT-160508FN-RP35C	654.986	0.8	15°	Al2O3-TiN	++	++	+	+	+		+	+	++		++	++	

CC..1605 chip-breakers ground

	CCMT-160508FL-MK10H	654.998	0.8	23°								++	+	++			+	
---	---------------------	---------	-----	-----	--	--	--	--	--	--	--	----	---	----	--	--	---	--

Accessories & Spare Parts

<p>Torx SET</p>  <p>► 515</p>	<p>Insert Clamping Screw</p>  <p>► 514</p>
--	---

1. γ Rake angle with insert on tool.
2. Inserts are sold in packages of 10 pieces.
3. The clamping screws for the inserts are supplied in packages of 10 pieces with a corresponding wrench.

= less suitable
 + = suitable
 ++ = first choice

Inserts SP

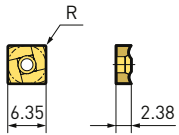

SP..0602 chip-breakers pressed

Insert Shape	Model	Order No.	Radius [mm]	Rake Angle γ	Cutting material / coating	Construction Steels	Heat Treatable Steels	Stainless Steels	Cast Iron GG	Cast Iron GGG	AL / Non-Ferrous Metals	Hardened Steel ≤56 HRC	NiCo Legierungen Titan	High Volume Machining	Unfavorable Conditions	Slightly Interrupted Cut	Heavily Interrupted Cut	HSC
	SPMT-060204FN-RK20C	654.152	0.4	15°	Al203-TiN				++	++		+	+	+			+	
	SPMT-060204FN-RK20H *	654.158	0.4	15°					+								++	
	SPMT-060204FN-RP20C	654.150	0.4	15°	Al203-TiN	++	++	++	+	+		+	+	+			+	

SP..0602 chip-breakers ground

	SPMT-060204FL-MK10H *	654.168	0.4	23°							++		+	+			+	
--	-----------------------	---------	-----	-----	--	--	--	--	--	--	----	--	---	---	--	--	---	--

Inserts SP

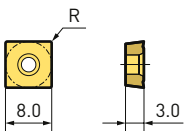

SP..0803 chip-breakers ground

	SPGT-080305FL-MP20H	654.183	5	5°		++	++	++		+	++	+					+	
--	---------------------	---------	---	----	--	----	----	----	--	---	----	---	--	--	--	--	---	--

Accessories & Spare Parts

<p>Torx SET</p> <p>► 515</p>	<p>Insert Clamping Screw</p> <p>► 514</p>
------------------------------	---

- γ Rake angle with insert on tool.
- Inserts are sold in packages of 10 pieces.
- The clamping screws for the inserts are supplied in packages of 10 pieces with a corresponding wrench.
- * As long as stock lasts.

= less suitable
 + = suitable
 ++ = first choice

Inserts SC

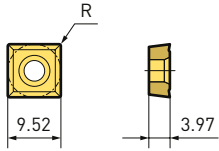

SC..09T3 chip-breakers pressed

Insert Shape	Model	Order No.	Radius [mm]	Rake Angle γ	Cutting material / coating	Construction Steels	Heat Treatable Steels	Stainless Steels	Cast Iron GG	Cast Iron GGG	AL / Non-Ferrous Metals	Hardened Steel ≤ 56 HRC	NiCo Legierungen Titan	High Volume Machining	Unfavorable Conditions	Slightly Interrupted Cut	Heavily Interrupted Cut	HSC
	SCMT-09T308FN-RK30H *	654.259	0.8	15°					+	+							+	
	SCMT-09T304FN-RP20C	654.240	0.4	15°	Al2O3-TiN	++	++	++	++	++		+		+	+	+		
	SCMT-09T308FN-RP20C	654.250	0.8	15°	Al2O3-TiN	++	++	++	++	++		+		+		+		
	SCMT-09T308FN-RP30C	654.251	0.8	15°	Al2O3-TiN	++	++	+	+	+		+		++		++	++	

SC..09T3 chip-breakers ground

	SCMT-09T304FL-MK10C	654.277	0.4	23°							++			+	+	+		
	SCMT-09T308FL-MK10C	654.287	0.8	23°							++			+			+	

Accessories & Spare Parts

<p>Torx SET</p> <p>► 515</p>	<p>Insert Clamping Screw</p> <p>► 514</p>
------------------------------	---

- * As long as stock lasts.
- γ Rake angle with insert on tool.
- Inserts are sold in packages of 10 pieces.
- The clamping screws for the inserts are supplied in packages of 10 pieces with a corresponding wrench.

= less suitable
 + = suitable
 ++ = first choice

Inserts SC

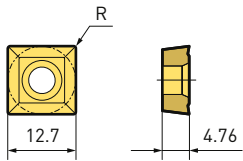

SC..1204 chip-breakers pressed

Insert Shape	Model	Order No.	Radius [mm]	Rake Angle γ	Cutting material / coating	Construction Steels	Heat Treatable Steels	Stainless Steels	Cast Iron GG	Cast Iron GGG	AL / Non-Ferrous Metals	Hardened Steel ≤ 56 HRC	NiCo Legierungen Titan	High Volume Machining	Unfavorable Conditions	Slightly Interrupted Cut	Heavily Interrupted Cut	HSC
	SCMT-120404FN-RP20C	654.340	0.4	15°	Al2O3-TiN	+	+	+	+	+		+			+	+		
	SCMT-120408FN-RP20C	654.350	0.8	15°	Al2O3-TiN	++	++	++	++	+		+		+			+	
	SCMT-120408FN-RP30C	654.351	0.8	15°	Al2O3-TiN	++	++	+	+	+		+	+	+		++	++	
	SCMT-120408FN-RP30H *	654.354	0.8	15°		+	+	+		+						++	++	

SC..1204 chip-breakers ground

	SCMT-120408FL-MK10H	654.387	0.8	23°							++			+			+	
--	---------------------	---------	-----	-----	--	--	--	--	--	--	----	--	--	---	--	--	---	--

Accessories & Spare Parts

<p>Torx SET</p> <p>► 515</p>	<p>Insert Clamping Screw</p> <p>► 514</p>
------------------------------	---

- * As long as stock lasts.
- γ Rake angle with insert on tool.
- Inserts are sold in packages of 10 pieces.
- The clamping screws for the inserts are supplied in packages of 10 pieces with a corresponding wrench.

= less suitable
 + = suitable
 ++ = first choice

Inserts WP 337

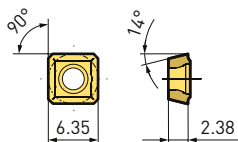

WP 337-1 ø16-20mm chip-breakers pressed

Insert Shape	Model	Order No.	Rake Angle γ	Cutting material / coating	Construction Steels	Heat Treatable Steels	Stainless Steels	Cast Iron GG	Cast Iron GGG	AL / Non-Ferrous Metals	Hardened Steel ≤ 56 HRC	NiCo Legierungen Titan	Long chipping materials	Tough materials	Inner Insert	Outer Insert
	WP337-1-16/20-RK40H	655.913	15°							++					+	+
	WP337-1-16/20-RM35C	655.912	15°	TiCN	+	+	+	+	+	+			++		+	++
	WP337-1-16/20-RP35C	655.910	15°	TiCN-Al ₂ O ₃ -TiN	++	++	+	++	+						+	+
	WP337-1-16/20-RP40C	655.911	15°	TiCN	+	+	+	+	+		+	+		++	++	+

Inserts WP 337

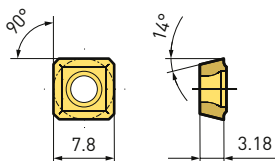

WP 337-2 ø21-25mm chip-breakers pressed

Insert Shape	Model	Order No.	Rake Angle γ	Cutting material / coating	Construction Steels	Heat Treatable Steels	Stainless Steels	Cast Iron GG	Cast Iron GGG	AL / Non-Ferrous Metals	Hardened Steel ≤ 56 HRC	NiCo Legierungen Titan	Long chipping materials	Tough materials	Inner Insert	Outer Insert
	WP337-2-21/25-RK40H	655.923	15°							++					+	+
	WP337-2-21/25-RM35C	655.922	15°	TiCN	+	+	+	+	+	+			++		+	++
	WP337-2-21/25-RP35C	655.920	15°	TiCN-Al ₂ O ₃ -TiN	++	++	+	++	+						+	+
	WP337-2-21/25-RP40C	655.921	15°	TiCN	+	+	+	+	+		+	+		++	++	+

Accessories & Spare Parts

<p>Torx SET</p> <p>► 515</p>	<p>Insert Clamping Screw</p> <p>► 514</p>
------------------------------	---

1. γ Rake angle with insert on tool.
2. Inserts are sold in packages of 10 pieces.
3. The clamping screws for the inserts are supplied in packages of 10 pieces with a corresponding wrench.

= less suitable
 + = suitable
 ++ = first choice

Inserts WP 337

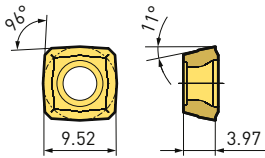

WP 337-3 ø26-30mm chip-breakers pressed

Insert Shape	Model	Order No.	Rake Angle γ	Cutting material / coating	Construction Steels	Heat Treatable Steels	Stainless Steels	Cast Iron GG	Cast Iron GGG	AL / Non-Ferrous Metals	Hardened Steel ≤ 56 HRC	NiCo Legierungen Titan	Long chipping materials	Tough materials	Inner Insert	Outer Insert
	WP337-3-26/30-RK40H	655.933	15°							++					+	+
	WP337-3-26/30-RP35C	655.930	15°	TiCN-Al ₂ O ₃ -TiN	++	++	+	++	+						+	+
	WP337-3-26/30-RP35C	655.932	15°	TiCN	+	+	+	+	+	+			++		+	++
	WP337-3-26/30-RP40C	655.931	15°	TiCN	+	+	+	+	+		+	+		++	++	+

Accessories & Spare Parts

<p>Torx SET</p> <p>► 515</p>	<p>Insert Clamping Screw</p> <p>► 514</p>
------------------------------	---

1. γ Rake angle with insert on tool.
2. Inserts are sold in packages of 10 pieces.
3. The clamping screws for the inserts are supplied in packages of 10 pieces with a corresponding wrench.

= less suitable
 + = suitable
 ++ = first choice

Inserts WC

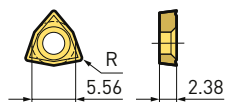

WC..0302 chip-breakers pressed

Insert Shape	Model	Order No.	Radius [mm]	Rake Angle γ	Cutting material / coating	Construction Steels	Heat Treatable Steels	Stainless Steels	Cast Iron GG	Cast Iron GGG	AL / Non-Ferrous Metals	Hardened Steel ≤56 HRC	NiCo Legierungen Titan	High Volume Machining	Unfavorable Conditions	Slightly Interrupted Cut	Heavily Interrupted Cut	HSC
	WCMT-030208FN-RK20C	655.621	0.8	15°	Al2O3-TiN				++	++	+							
	WCMT-030208FN-RM40C *	655.622	0.8	15°	TiCN	+	+	++										
	WCMT-030208FN-RP45C	655.620	0.8	15°	TiCN-TiN	++	++		+	+								

Inserts WC

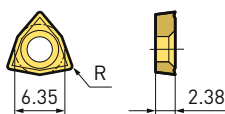

WC..0402 chip-breakers pressed

Insert Shape	Model	Order No.	Radius [mm]	Rake Angle γ	Cutting material / coating	Construction Steels	Heat Treatable Steels	Stainless Steels	Cast Iron GG	Cast Iron GGG	AL / Non-Ferrous Metals	Hardened Steel ≤56 HRC	NiCo Legierungen Titan	High Volume Machining	Unfavorable Conditions	Slightly Interrupted Cut	Heavily Interrupted Cut	HSC
	WCMT-040208FN-RK20C	655.631	0.8	15°	Al2O3-TiN				++	++	+							
	WCMT-040208FN-RM40C *	655.632	0.8	15°	TiCN	+	+	++										
	WCMT-040208FN-RP45C	655.630	0.8	15°	TiCN-TiN	++	++		+	+								

B.5

Accessories & Spare Parts

<p>Torx SET</p> <p>► 515</p>	<p>Insert Clamping Screw</p> <p>► 514</p>
------------------------------	---

- γ Rake angle with insert on tool.
- Inserts are sold in packages of 10 pieces.
- The clamping screws for the inserts are supplied in packages of 10 pieces with a corresponding wrench.
- * As long as stock lasts.

= less suitable
 + = suitable
 ++ = first choice

Inserts WC

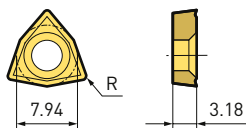

WC..0503 chip-breakers pressed

Insert Shape	Model	Order No.	Radius [mm]	Rake Angle γ	Cutting material / coating	Construction Steels	Heat Treatable Steels	Stainless Steels	Cast Iron GG	Cast Iron GGG	AL / Non-Ferrous Metals	Hardened Steel ≤ 56 HRC	NiCo Legierungen Titan	High Volume Machining	Unfavorable Conditions	Slightly Interrupted Cut	Heavily Interrupted Cut	HSC
	WCMT-050308FN-MP45C	655.640	0.8	15°	TiN	++	++	++	+	+								
	WCMT-050308FN-RK20C	655.641	0.8	15°	TiCN-Al2O3				++	++	+							
	WCMT-050308FN-RP40C	655.644	0.8	15°	TiN	++	++	++	+	+								
	WCMT-050308FN-RP45C	655.642	0.8	15°	TiN	++		+										

Inserts WC

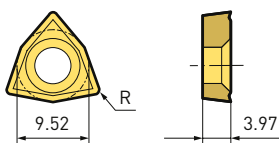

WC..06T3 chip-breakers pressed

Insert Shape	Model	Order No.	Radius [mm]	Rake Angle γ	Cutting material / coating	Construction Steels	Heat Treatable Steels	Stainless Steels	Cast Iron GG	Cast Iron GGG	AL / Non-Ferrous Metals	Hardened Steel ≤ 56 HRC	NiCo Legierungen Titan	High Volume Machining	Unfavorable Conditions	Slightly Interrupted Cut	Heavily Interrupted Cut	HSC
	WCMT-06T308FN-MP45C	655.650	0.8	15°	TiN	++	++	++	+	+								
	WCMT-06T308FN-RK20C	655.651	0.8	15°	TiCN-Al2O3				++	++	+							
	WCMT-06T308FN-RP40C	655.654	0.8	15°	TiN	++	++	++	+	+								
	WCMT-06T308FN-RP45C	655.652	0.8	15°	TiN	++		+										

B.5

Accessories & Spare Parts

<p>Torx SET</p> <p>► 515</p>	<p>Insert Clamping Screw</p> <p>► 514</p>
------------------------------	---

1. γ Rake angle with insert on tool.
2. Inserts are sold in packages of 10 pieces.
3. The clamping screws for the inserts are supplied in packages of 10 pieces with a corresponding wrench.

= less suitable
 + = suitable
 ++ = first choice

Inserts WC

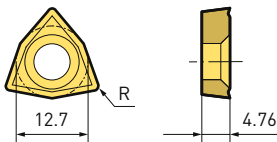

WC..0804 chip-breakers pressed

Insert Shape	Model	Order No.	Radius [mm]	Rake Angle γ	Cutting material / coating	Construction Steels	Heat Treatable Steels	Stainless Steels	Cast Iron GG	Cast Iron GGG	AL / Non-Ferrous Metals	Hardened Steel ≤ 56 HRC	NiCo Legierungen Titan	High Volume Machining	Unfavorable Conditions	Slightly Interrupted Cut	Heavily Interrupted Cut	HSC
	WCMT-080412FN-MP45C	655.660	1.2	15°	TiN	++	++	++	+	+								
	WCMT-080412FN-RK20C	655.661	1.2	15°	TiCN-Al2O3				++	++	+							
	WCMT-080412FN-RP40C	655.664	1.2	15°	TiN	++	++	++	+	+								
	WCMT-080412FN-RP45C	655.662	1.2	15°	TiN	+		+										

Inserts WC

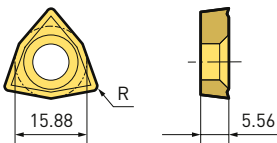

WC..1005 chip-breakers pressed

Insert Shape	Model	Order No.	Radius [mm]	Rake Angle γ	Cutting material / coating	Construction Steels	Heat Treatable Steels	Stainless Steels	Cast Iron GG	Cast Iron GGG	AL / Non-Ferrous Metals	Hardened Steel ≤ 56 HRC	NiCo Legierungen Titan	High Volume Machining	Unfavorable Conditions	Slightly Interrupted Cut	Heavily Interrupted Cut	HSC
	WCMT-100512FN-RK20H	655.671	1.2	15°					+	+	+							
	WCMT-100512FN-RP45C	655.670	1.2	15°	TiCN	++	++	++	++	++								

Accessories & Spare Parts

<p>Torx SET</p> <p>► 515</p>	<p>Insert Clamping Screw</p> <p>► 514</p>
------------------------------	---

1. γ Rake angle with insert on tool.
2. Inserts are sold in packages of 10 pieces.
3. The clamping screws for the inserts are supplied in packages of 10 pieces with a corresponding wrench.

= less suitable
 + = suitable
 ++ = first choice

Inserts WC

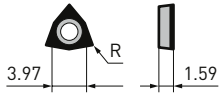

Fig. 1





Fig. 2

WC..0201 PKD/CBN cutting edge

Insert Shape	Model	Order No.	Radius [mm]	Rake Angle γ	Cutting material / coating	Cast Iron GG	Cast Iron GGG	AL / Non-Ferrous Metals	Hardened Steel ≤56 HRC	NiCo Legierungen Titan	High Volume Machining	Unfavorable Conditions	Slightly Interrupted Cut	Heavily Interrupted Cut	HSC	Fig.
	WCGW-020102TN-FH10CBN	948.101	0.2	0°	CBN-30				++		++		++	++		2
	WCGW-020102FN-FH10CBN-X3	938.885	0.2	0°	CBN-25				++	+	++					1
	WCGW-020102FN-FK10CBN-X3	938.884	0.2	0°	CBN-10		++				++	+	+			1
	WCGW-020102FN-FN10PKD-X3	938.883	0.2	0°	PCD			++			++		+		+	1

Accessories & Spare Parts

<p>Torx SET</p>  <p>► 515</p>	<p>Insert Clamping Screw</p>  <p>► 514</p>
--	---

- γ Rake angle with insert on tool.
- The clamping screws for the inserts are supplied in packages of 10 pieces with a corresponding wrench.
- CBN/PCD inserts are sold individually.

= less suitable
 + = suitable
 ++ = first choice

Inserts TP

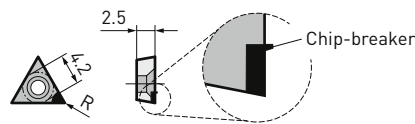

Fig. 1

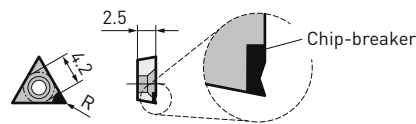

Fig. 2

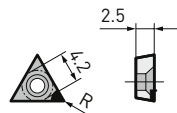

Fig. 3

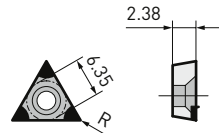

Fig. 4

Figure 1 and 2 are with chipbreaker.

TP..0702 PKD/CBN cutting edge

Insert Shape	Model	Order No.	Radius [mm]	Rake Angle γ	Cutting material / coating	Cast Iron GG	Cast Iron GGG	AL / Non-Ferrous Metals	Hardened Steel ≤ 56 HRC	NiCo Legierungen Titan	High Volume Machining	Unfavorable Conditions	Slightly Interrupted Cut	Heavily Interrupted Cut	HSC	Fig.	
	TPGW-070201TN-FH10CBN	948.270	0.1	5°	CBN-30				++		++	+	+			3	
	TPGW-070203TN-FH10CBN	948.271	0.3	5°	CBN-30				++		++		++	+		3	
	TPGW-070202FN-FK10CBN	948.210	0.2	5°	CBN-15	++	++			+	+	+				3	
	TPGW-070202TN-FK10CBN	948.230	0.2	5°	CBN-15	++	++				++	+	++			3	
	TPGW-070203FN-FK10CBN	938.837	0.3	5°	CBN-10	++	+			+	+					3	
	TPGW-070203TN-FK10CBN	938.879	0.3	5°	CBN-10	++	+				++		++			3	
	TPGW-070204FN-FK10CBN	948.211	0.4	5°	CBN-15	++	++			+	+		+			3	
	TPGW-070204TN-FK10CBN	948.231	0.4	5°	CBN-15	++	++				++		++	+		3	
	TPGT-070202FL-FN10PKD	948.202	0.2	8°	PCD			++									2
	TPGW-070203FN-FN10PKD	938.840	0.3	5°	PCD			++			++		+		+	3	
	TPGT-070204FL-FN10PKD	948.203	0.4	8°	PCD			++								2	
	TPGW-070204FL-MN10PKD	948.201	0.4	5°	PCD			+			++		+		++	1	
	TPGW-070202FN-FH10CBN-X3	948.252	0.2	0°	CBN-30				++	++	+	+					4
	TPGW-070203FN-FH10CBN-X3	948.251A	0.3	0°	CBN-30				++	++	+						4
	TPGW-070204FN-FH10CBN-X3	948.253	0.4	0°	CBN-30				++	++	+						4

B.5

Accessories & Spare Parts

<p>Torx SET</p> <p>► 515</p>	<p>Insert Clamping Screw</p> <p>► 514</p>
------------------------------	---

1. γ Rake angle with insert on tool.
2. The clamping screws for the inserts are supplied in packages of 10 pieces with a corresponding wrench.
3. CBN/PCD inserts are sold individually.

= less suitable
 + = suitable
 ++ = first choice

Inserts TC

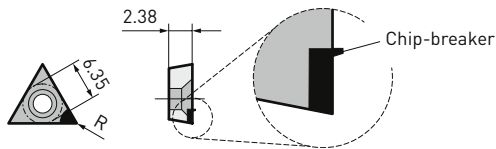

Fig. 1

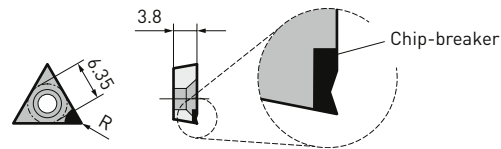

Fig. 2

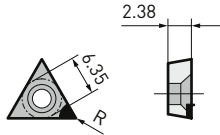

Fig. 3

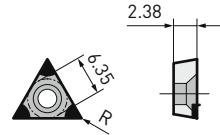

Fig. 4

Figure 1 and 2 are with chipbreaker.

TC..1102 PKD/CBN cutting edge

Insert Shape	Model	Order No.	Radius [mm]	Rake Angle γ	Cutting material / coating	Cast Iron GG	Cast Iron GGG	AL / Non-Ferrous Metals	Hardened Steel ≤ 56 HRC	NiCo Legierungen Titan	High Volume Machining	Unfavorable Conditions	Slightly Interrupted Cut	Heavily Interrupted Cut	HSC	Fig.
	TCMW-110202TN-FH10CBN	948.370	0.2	0°	CBN-30				++	++	+	+				3
	TCMW-110204TN-FH10CBN	948.371	0.4	0°	CBN-30				++	++		++				3
	TCMW-110208TN-FH10CBN	948.372	0.8	0°	CBN-30				++	++		++	+			3
	TCMW-110202FN-FK10CBN	948.310	0.2	0°	CBN-15	++	++			+	++	++				3
	TCMW-110202TN-FK10CBN	948.330	0.2	0°	CBN-15	++	++				++	+				3
	TCMW-110204FN-FK10CBN	948.311	0.4	0°	CBN-15	++	++			+	++	+	+			3
	TCMW-110204TN-FK10CBN	948.331	0.4	0°	CBN-15	++	++				++		+			3
	TCMW-110208FN-FK10CBN	948.312	0.8	0°	CBN-15	++	++			+	++	+	+			3
	TCMW-110208TN-FK10CBN	948.332	0.8	0°	CBN-15	++	++				++		++	+		3
	TCGT-110202FL-FN10PKD	948.373	0.2	8°	PCD			++			++		+		++	2
	TCGT-110204FL-FN10PKD	948.374	0.4	8°	PCD			++			++		+		++	2
	TCMW-110204FN-FN10PKD	938.841	0.4	5°	PCD			++			++		+		+	3
	TCGT-110208FL-FN10PKD	948.375	0.8	8°	PCD			++			++		+		++	2
	TCMW-110204FL-MN10PKD	948.301	0.4	0°	PCD			+			++		+		++	1
	TCMW-110208FL-MN10PKD	948.302	0.8	0°	PCD			+			++		+		++	1
	TCMW-110204FN-NK10CBN	938.834	0.4	0°	CBN-10	++	+			+	++	+	+			3
	TCMW-110208TN-NK10CBN	938.876	0.8	0°	CBN-10	++	+				++		+			3
	TCMW-110202FN-FH10CBN-X3	948.350A	0.2	0°	CBN-30				++	++	+	+				4
	TCMW-110204FN-FH10CBN-X3	948.351A	0.4	0°	CBN-30				++	++	+					4
	TCMW-110208FN-FH10CBN-X3	948.352A	0.8	0°	CBN-30				++	++	++		+			4

B.5

Accessories & Spare Parts

<p>Torx SET</p> <p>► 515</p>	<p>Insert Clamping Screw</p> <p>► 514</p>
------------------------------	---

1. γ Rake angle with insert on tool.
2. The clamping screws for the inserts are supplied in packages of 10 pieces with a corresponding wrench.
3. CBN/PCD inserts are sold individually.
4. Figure 1 and 2 are with chipbreaker.

= less suitable
 + = suitable
 ++ = first choice

Inserts CC

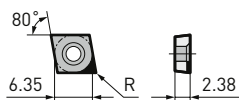

CC..0602 PKD/CBN cutting edge

Insert Shape	Model	Order No.	Radius [mm]	Rake Angle γ	Cutting material / coating	Cast Iron GG	Cast Iron GGG	AL / Non-Ferrous Metals	Hardened Steel ≤56 HRC	NiCo Legierungen Titan	High Volume Machining	Unfavorable Conditions	Slightly Interrupted Cut	Heavily Interrupted Cut	HSC
	CCGW-060204FN-FK10CBN	938.867	0.4	0°	CBN-10	++	+				++				
	CCGT-060204FL-FN10PKD	938.866	0.4	5°	PCD			++			++		+		

Inserts CC

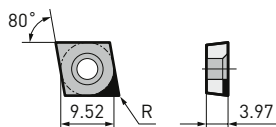

CC..09T3 PKD/CBN cutting edge

Insert Shape	Model	Order No.	Radius [mm]	Rake Angle γ	Cutting material / coating	Cast Iron GG	Cast Iron GGG	AL / Non-Ferrous Metals	Hardened Steel ≤56 HRC	NiCo Legierungen Titan	High Volume Machining	Unfavorable Conditions	Slightly Interrupted Cut	Heavily Interrupted Cut	HSC
	CCGW-09T304FN-FK10CBN	938.869	0.4	0°	CBN-10	++	+				++				
	CCGW-09T308FN-FK10CBN	938.835	0.8	0°	CBN-10	++	+				++		+		
	CCGT-09T304FL-FN10PKD	938.868	0.4	5°	PCD			++			++		+		

Accessories & Spare Parts

<p>Torx SET</p> <p>► 515</p>	<p>Insert Clamping Screw</p> <p>► 514</p>
------------------------------	---

- γ Rake angle with insert on tool.
- Inserts are sold in packages of 10 pieces.
- CBN/PCD inserts are sold individually.

= less suitable
 + = suitable
 ++ = first choice

Inserts CC

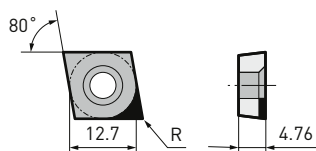

CC..1204 PKD/CBN cutting edge

Insert Shape	Model	Order No.	Radius [mm]	Rake Angle γ	Cutting material / coating	Cast Iron GG	Cast Iron GGG	AL / Non-Ferrous Metals	Hardened Steel ≤ 56 HRC	NiCo Legierungen Titan	High Volume Machining	Unfavorable Conditions	Slightly Interrupted Cut	Heavily Interrupted Cut	HSC
	CCGW-120408FN-FK10CBN	938.862	0.8	0°	CBN-10	++	+				++		+		
	CCGT-120404FL-FN10PKD	938.870	0.4	5°	PCD			++			++	+	+		
	CCGT-120408FL-FN10PKD	938.871	0.8	5°	PCD			++			++		+		

B.5

Accessories & Spare Parts

<p>Torx SET</p> <p>► 515</p>	<p>Insert Clamping Screw</p> <p>► 514</p>
------------------------------	---

1. γ Rake angle with insert on tool.
2. Inserts are sold in packages of 10 pieces.
3. CBN/PCD inserts are sold individually.

= less suitable
 + = suitable
 ++ = first choice

Inserts CN

CN..1204 / 1606 /1906 chip-breakers pressed

Insert Shape	Model	Order No.	Radius [mm]	Cutting material / coating	Construction Steels	Heat Treatable Steels	Stainless Steels	Cast Iron GG	Cast Iron GGG	AL / Non-Ferrous Metals	Hardened Steel ≤56 HRC	Titanium	High temperature steels	Availability
	CNGA-120404TN-MH20CBN	656.050	0.4	CBN							++			○
	CNGA-120408TN-MH20CBN	656.051	0.8	CBN							++			○
	CNMG-120404FN-MK10C	656.020	0.4			+		++	++					○
	CNMG-120408FN-MK10C	656.021	0.8			+		++	++					○
	CNMG-160608FN-MK10C	656.022	0.8			+		++	++					○
	CNMG-120404FN-MM20C	656.011	0.4				++						+	○
	CNMG-120408FN-MM20C	656.012	0.8				++						+	○
	CNMG-160608FN-MM20C	656.016	0.8				++						+	○
	CNMG-190608FN-MM20C	656.015	0.8				++						+	○
	CNMG-120404FN-MP10C	656.000	0.4		++	++		+	+					▲
	CNMG-120408FN-MP10C	656.001	0.8		++	++		+	+					▲
	CNMG-160608FN-MP10C	656.004	0.8		++	++		+	+					○
	CNMG-190608FN-MP10C	656.005	0.8		++	++		+	+					○
	CNMG-120404FN-MS20C	656.042	0.4				+						++	▲
	CNMG-120408FN-MS20C	656.043	0.8				+						++	▲
	CNMG-120404FN-MS20H	656.040	0.4									++		○
CNMG-120408FN-MS20H	656.041	0.8									++		○	

1. Inserts are sold in packages of 10 pieces.
2. CBN Inserts are available in pieces.

○ delivery time 1 week
▲ from stock

= less suitable
+ = suitable
++ = first choice

Inserts DN

DN..1506 chip-breakers pressed

Insert Shape	Model	Order No.	Radius [mm]	Cutting material / coating	Construction Steels	Heat Treatable Steels	Stainless Steels	Cast Iron GG	Cast Iron GGG	AL / Non-Ferrous Metals	Hardened Steel ≤56 HRC	Titanium	High temperature steels	Availability
	DNGA-150604TN-MH20CBN	656.152	0.4	CBN							++			○
	DNGA-150608TN-MH20CBN	656.153	0.8	CBN							++			○
	DNMG-150604FN-MK10C	656.122	0.4			+		++	++					○
	DNMG-150608FN-MK10C	656.123	0.8			+		++	++					○
	DNMG-150604FN-MM20C	656.112	0.4				++						+	○
	DNMG-150608FN-MM20C	656.113	0.8				++						+	○
	DNMG-150604FN-MP10C	656.102	0.4		++	++		+	+					▲
	DNMG-150608FN-MP10C	656.103	0.8		++	++		+	+					▲
	DNMG-150604FN-MS20C	656.146	0.4				+						++	▲
	DNMG-150608FN-MS20C	656.147	0.8				+						++	▲
	DNMG-150604FN-MS20H	656.142	0.4									++		○
	DNMG-150608FN-MS20H	656.143	0.8									++		○

Inserts DC

DC..11T3 chip-breakers pressed

Insert Shape	Model	Order No.	Radius [mm]	Cutting material / coating	Construction Steels	Heat Treatable Steels	Stainless Steels	Cast Iron GG	Cast Iron GGG	AL / Non-Ferrous Metals	Hardened Steel ≤56 HRC	Titanium	High temperature steels	Availability
	DCGT-11T304FN-FN10H	656.130	0.4			+	+	+		++				▲
	DCGT-11T308FN-FN10H	656.131	0.8			+	+	+		++				▲
	DCGW-11T304TN-MH20CBN	656.150	0.4	CBN							++			○
	DCGW-11T308TN-MH20CBN	656.151	0.8	CBN							++			○
	DCMT-11T304FN-MK10C	656.120	0.4			+		++	++					○
	DCMT-11T308FN-MK10C	656.121	0.8			+		++	++					○
	DCMT-11T304FN-MM20C	656.110	0.4				++						+	○
	DCMT-11T308FN-MM20C	656.111	0.8				++						+	○
	DCMT-11T304FN-MP10C	656.100	0.4		++	++		+	+					▲
	DCMT-11T308FN-MP10C	656.101	0.8		++	++		+	+					▲
	DCMT-11T304FN-MS10H	656.140	0.4									++		○
	DCMT-11T308FN-MS10H	656.141	0.8									++		○
	DCMT-11T304FN-MS20C	656.144	0.4				+						++	▲
DCMT-11T308FN-MS20C	656.145	0.8				+						++	▲	

1. Inserts are sold in packages of 10 pieces.
2. CBN Inserts are available in pieces.

○ delivery time 1 week
▲ from stock

= less suitable
+ = suitable
++ = first choice

Inserts VN

VN..1604 chip-breakers pressed

Insert Shape	Model	Order No.	Radius [mm]	Cutting material / coating	Construction Steels	Heat Treatable Steels	Stainless Steels	Cast Iron GG	Cast Iron GGG	AL / Non-Ferrous Metals	Hardened Steel ≤56 HRC	Titanium	High temperature steels	Availability
	VNMG-160404FN-MM20C	656.310	0.4				++						+	○
	VNMG-160408FN-MM20C	656.311	0.8				++						+	○
	VNMG-160404FN-MP10C	656.300	0.4		++	++		+	+					○
	VNMG-160408FN-MP10C	656.301	0.8		++	++		+	+					○

Inserts VB

VB..1604 chip-breakers pressed

	VBMT-160404FN-MK10C	656.320	0.4			+		++	++					○
	VBMT-160408FN-MK10C	656.321	0.8			+		++	++					○
	VBMT-160404FN-MM20C	656.312	0.4				++						+	○
	VBMT-160408FN-MM20C	656.313	0.8				++						+	○
	VBGW-160404TN-MN20CBN	656.351	0.4	CBN							++			○
	VBGW-160408TN-MN20CBN	656.352	0.8	CBN							++			○
	VBMT-160404FN-MP10C	656.302	0.4		++	++		+	+					▲
	VBMT-160408FN-MP10C	656.303	0.8		++	++		+	+					▲
	VBMT-160404FN-MS10H	656.340	0.4									++		○
	VBMT-160408FN-MS10H	656.341	0.8									++		○
	VBMT-160404FN-MS20C	656.342	0.4				+						++	○
	VBMT-160408FN-MS20C	656.343	0.8				+						++	○

Inserts VC

B.5

VC..1604 chip-breakers pressed

	VCGT-160404FN-FN10H	656.330	0.4			+	+	+		++				▲
	VCGT-160408FN-FN10H	656.331	0.8			+	+	+		++				▲
	VCGT-110302-K20	655.822	0.2	K20						++				▲
	VCMT-110302-P20C	655.821	0.2	P20C		++	+	++	++					▲

Inserts TN

TN..1604 / 2204 chip-breakers pressed

	TNMG-160404FN-MM20C	656.210	0.4				++						+	○
	TNMG-160408FN-MM20C	656.211	0.8				++						+	○
	TNMG-220408FN-MM20C	656.212	0.8				++						+	○
	TNMG-160404FN-MP10C	656.201	0.4		++	++		+	+					○
	TNMG-160408FN-MP10C	656.202	0.8		++	++		+	+					○
	TNMG-220404FN-MP10C	656.203	0.4		++	++		+	+					○
	TNMG-220408FN-MP10C	656.204	0.8		++	++		+	+					○

1. Inserts are sold in packages of 10 pieces.
2. CBN Inserts are available in pieces.

- delivery time 1 week
- ▲ from stock

- = less suitable
- + = suitable
- ++ = first choice

Carbide inserts for circlip grooves as per DIN 472

Insert			Dimensions			Work Piece Material		
Insert Shape	Order No.	Grade	Capacity ØD	Width of Groove E	Depth of Groove B	Cast Iron	Steel	Aluminium

DN0

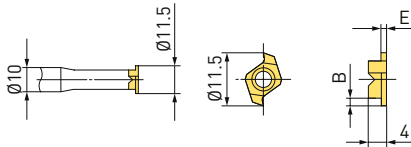

Type 0	Order No.	Grade	Capacity ØD	Width of Groove E	Depth of Groove B	Cast Iron	Steel	Aluminium
	958.052	K20	12 - 24	1.15	0.9	++		
	958.051	P20					++	
	958.053	K20						++
	958.056	K20	12 - 24	1.35	1.3	++		
	958.055	P20					++	
Blank	958.313	K20						
	958.314	P20						

DN1

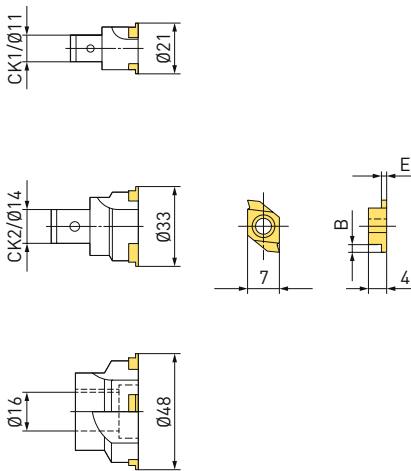

Type 1	Order No.	Grade	Capacity ØD	Width of Groove E	Depth of Groove B	Cast Iron	Steel	Aluminium
	958.062	K20	22 - 34	1.15	1.1	++		
	958.061	P20					++	
	958.063	K20						++
	958.066	K20	22 - 34	1.35	1.5	++		
	958.065	P20					++	
	958.067	K20	34 - 50	1.65	1.6		++	
	958.072	K20						++
	958.071	P20					++	
	958.073	K20	34 - 50	1.90	2.0	++		
	958.076	K20					++	
	958.075	P20	50 - 85	2.20	2.2		++	
	958.077	K20						++
	958.082	K20					++	
	958.081	P20	50 - 85	2.70	2.6		++	
	958.083	K20						++
958.086	K20	50 - 85	2.70	2.6	++			
958.085	P20					++		
Blank	958.087	K20						++
	958.157	K20						
	958.158	P20						

	Model	Order No.
	Torx T8 M3x9.0	958.048

	Model	Order No.
	Torx T8	694.183

DN2

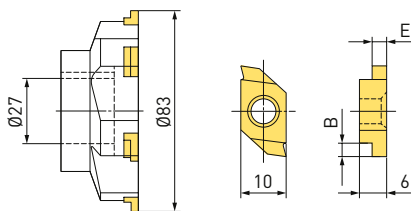

Type 2	Order No.	Grade	Capacity ØD	Width of Groove E	Depth of Groove B	Cast Iron	Steel	Aluminium
	958.092	K20	> 85	3.20	3.0	++		
	958.091	P20					++	
	958.093	K20						++
	958.096	K20	> 85	4.20	3.5	++		
	958.095	P20					++	
Blank	958.097	K20						++
	958.155	K20						
	958.156	P20						

	Model	Order No.
	Torx T20 M5x16.5	958.049

	Model	Order No.
	Torx T20	694.187

Clamping screw (10 screws and 1 wrench)
Inserts are available in pieces.

= less suitable
+ = suitable
++ = first choice

Spare Parts

Modular Components Shanks	496
Indexable Insert Drills / Rough Boring Heads / Insert Holders	499
Fine Boring Heads / Centric Insert Holders	502
Fine Boring Heads / Peripheral Insert Holders	505
Series 318 Large Diameter Boring Tools	507
Face Grooving / OD Turning / Chamfering / Milling	509
Tool Holders / Tapping Attachments	511
Screws and Wrenches	512

CKB connection

CK- screws and allen wrenches

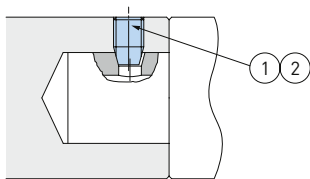

Clamping Screw					Allen Wrench		
CK	A	B	①	M [Nm] *	CK	SW	②
CK1	M4 x 0.5	5	690.431	1.5	CK1	2	690.801
CK2	M5 x 0.5	6.5	690.432	3.0	CK2	2.5	690.802
CK3	M6 x 0.75	8.5	690.433	4.5	CK3	3	690.803
CK4	M8 x 0.75	11	690.434	7.0	CK4	4	690.804
CK5	M10 x 1	14	690.435	14.0	CK5	5	690.805
CK5	M10 x 1	12	690.594 *	14.0	CK5	5	690.805
CK6	M12 x 1	18	690.436	24.0	CK6	6	690.806
CK7	M20 x 1.5	29	690.437	45.0	CK7	10	690.808

1. * Shanks 326.005 / 329.866

Cross bolts and locking rings

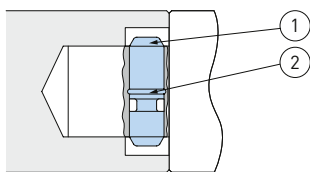

Cross Bolts				O-Ring	Snap Ring
CK	A	B	①	②	②
CKB1	4	13.5	691.501	692.270	
CKB2	5	17	691.502	692.271	
CKB3	7	22	691.503	692.272	
CKB4	8.5	26.5	691.504	692.286	
CKB5	11	33	691.505		693.304
CKB6	14	43	691.506		693.305
CKB7	18	56	691.507		693.306

* M = Recommended torque for tightening the screws

CKN connection

CK- screws and allen wrenches

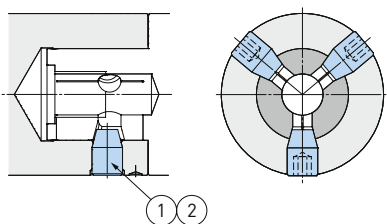

CKN	Clamping Screws			Allen Wrenches		
	A	B	①	M [Nm] *	SW	②
CKN6	M12 x 1	18	690.436	24	6	690.806
CKN7	M20 x 1.5	29	690.437	45	10	690.808

Blind screws

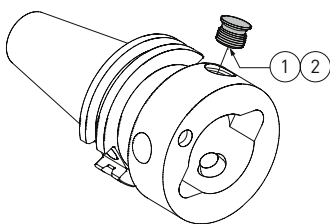

Type	Blind Screws		Allen Wrenches	
	①	SW	②	
CKN6	690.666	6	690.806	
CKN7	690.667	10	690.810	

* M = Recommended torque for tightening the screws

Shanks

Set screws for coolant bores

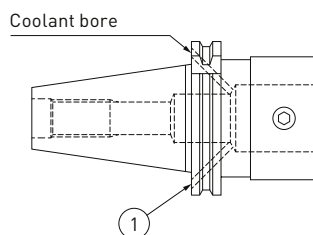

ISO	①	Remarks
30	690.451	
40	690.451	Only for shanks 323.826, 326.041
	690.419	Only for shank 326.163
50	690.576	

B.6

Shanks and tool holders for bridge tools Series 318, Ø 620 - 3000 mm

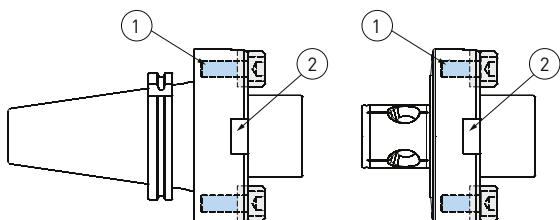

Type	①	②
328.215	690.131	691.637
328.213	690.131	
328.214	690.131	
328.217N	690.172	

* M = Recommended torque for tightening the screws

Adjustable drill holder

Set screws for coolant bores

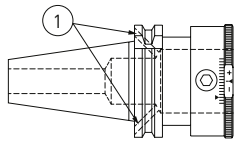

Type	①
336.301	690.451
336.302	690.419
336.303	690.419
336.304	690.573

Indexable insert drills, Series 336/337

Clamp screws for inserts

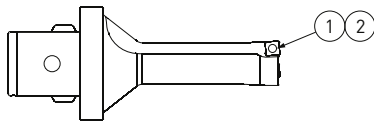

Type	①**	M [Nm] *	②
WP 337-1	694.123	0.7	694.807
WP 337-2	694.130	0.7	694.807
WP 337-3	694.136	1.8	694.810

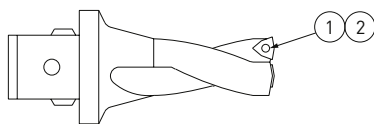

Type	①**	M [Nm] *	②
WC 03	694.110	0.7	694.807
WC 04	694.124	0.7	694.807
WC 05	694.131	0.5	694.809
WC 06	694.137	1.8	694.810
WC 08	694.143	3.0	694.815
WC 10	694.150	6.0	694.820

Boring heads for roughing SW, Series 319

B.6

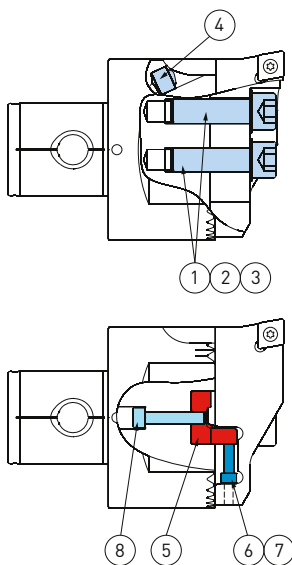



Type	①	②	M [Nm] *	③	④	⑤	⑥	⑦	⑧
SW20	690.188	693.175	4.0	690.803		319.150	690.191	690.819	690.184
SW25	690.157	693.176	7.0	690.804		319.250	690.192	690.819	690.186
SW32	690.108	693.177	12.0	690.805		319.350	690.193	690.811	690.189
SW41	690.163	693.178	20.0	690.806		319.450	690.194	690.812	690.189
SW53	690.105	693.179	35.0	690.807	692.409	319.550	690.195	690.812	690.189
SW68	690.106	693.179	35.0	690.807	692.406	319.650	690.196	690.813	690.101
SW98 x CKB6	690.970	693.187	40.0	690.810	692.406	319.750	690.197	690.814	690.108
SW98 x CKB7	690.970	693.187	40.0	690.810	692.406	319.750	690.197	690.814	690.173
SW148 x CKB6	690.970	693.187	40.0	690.810	692.406	319.750	690.197	690.814	690.108
SW148 x CK7	690.970	693.187	40.0	690.810	692.406	319.750	690.197	690.814	690.173

* M = Recommended torque for tightening the screws

** Per package: 10 screws and 1 wrench

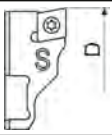
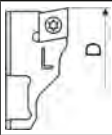
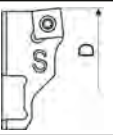
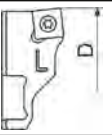
Insert holders

	Type CC			Type SC/SP			Type WC		
Type	D			D			D		



Preferential line



SW20	20 - 26	639.411	639.412	20 - 26	639.111	639.112			
	25 - 31	639.415	639.416						
SW25	25 - 33	639.421	639.422	25 - 33	639.121	639.122			
	32 - 40	639.425	639.426						
SW32	32 - 42	639.431	639.432	32 - 42	639.131	639.132			
	41 - 51	639.435	639.436	41 - 51	639.135	639.136			
SW41	41 - 54	639.441	639.442	41 - 54	639.141	639.142	49 - 62	639.241	639.242
	53 - 66	639.445	639.446	53 - 66	639.145	639.146			
SW53	53 - 70	639.451	639.452	53 - 70	639.151	639.152	59 - 76	639.251	639.252
	69 - 86	639.455	639.456	69 - 86	639.155	639.156	69 - 86	639.255	639.252
SW68	68 - 90	639.461	639.462	68 - 90	639.161	639.162	73 - 95	639.261	639.262
	88 - 110	639.465	639.466	88 - 110	639.165	639.166	90 - 112	639.265	639.266
SW98	98 - 126	639.471	639.472	98 - 126	639.171	639.172	106 - 134	639.271	639.272
	125 - 153	639.475	639.476	125 - 153	639.175	639.176	131 - 159	639.275	639.276
SW148	148 - 176	639.481	639.482	148 - 176	639.181	639.182	156 - 184	639.281	639.282
	175 - 203	639.485	639.486	175 - 203	639.185	639.186	181 - 209	639.285	639.286



Additional line

SW68	68 - 90	639.561	639.562
	88 - 110	639.565	639.566
SW98	98 - 126	639.571	639.572
	125 - 153	639.575	639.576
SW148	148 - 176	639.581	639.582
	175 - 203	639.585	639.586

Clamp screws for inserts

			
Type	**	M [Nm] *	
CC 06	694.122	0.7	694.807
CC 09	694.141	3.0	694.815
CC 12	694.150	6.0	694.820
CC 16	694.150	6.0	694.820

			
Type	**	M [Nm] *	
SP 06	694.122	0.7	694.807
SC 09	694.141	3.0	694.815
SC 12	694.150	6.0	694.820

			
Type	**	M [Nm] *	
WC 04	694.124	0.7	694.807
WC 05	694.131	1.5	694.809
WC 06	694.137	1.8	694.810

* M = Recommended torque for tightening the screws

** Per package: 10 screws and 1 wrench

Boring Heads for Roughing, Insert Holders

Insert holders SW, for chamfering

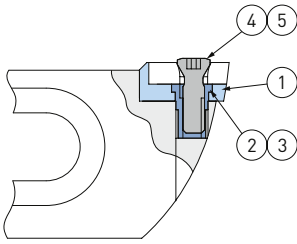

Type	①	②	③		④ **	M [Nm] *	⑤
639.191	695.101	691.756	690.899	SC 09	694.138	3.0	694.815
639.192	695.101	691.756	690.899		694.138		694.815
639.193	695.101	691.755	690.899		694.138		694.815
639.194	695.102	691.757	690.804	SC 12	694.145	3.0	694.815
639.195	695.102	691.757	690.804		694.145		694.815
639.196	695.102	691.757	690.804		694.145		694.815
639.197	695.102	691.757	690.804		694.145		694.815

Insert holders SW, back boring

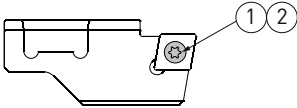

Type	① **	M [Nm] *	②
639.490	694.141	3.0	694.815
639.491	694.141		694.815
639.492	694.150	3.0	694.820
639.493	694.150		694.820

Type	① **	M [Nm] *	②
639.494	694.150	3.0	694.820
639.495	694.150		694.820
639.496	694.150		694.820
639.497	694.150		694.820

* M = Recommended torque for tightening the screws

** Per package: 10 screws and 1 wrench



CHF

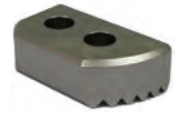

DP

Insert holders for chamfering

Model	Order No.	Model	Order No.	Image	Diameter Range					L ***
					15° min - max	30° min - max	45° min - max	60° min - max	75° min - max	
CHF-SW41SC09	639.191	DP-SW41	639.914	SC09	33 - 60	36 - 62	39 - 63	43 - 63	45 - 62	51
CHF-SW53SC09	639.192	DP-SW53	639.915		45 - 76	48 - 78	51 - 79	55 - 79	57 - 78	58
CHF-SW68SC09	639.193	DP-SW68	639.916		61 - 97	64 - 99	67 - 100	71 - 100	73 - 99	68
CHF1-SW98SC12	639.194	DP-SW98	639.917	SC12	77 - 126	81 - 128	86 - 129	90 - 128	94 - 127	73 / 89 / 119
CHF2-SW98SC12	639.195				104 - 153	108 - 155	113 - 156	117 - 155	121 - 154	
CHF1-SW148SC12	639.196	DP-SW148	639.918		131 - 180	135 - 182	140 - 183	144 - 182	148 - 181	73 / 119
CHF2-SW148SC12	639.197				158 - 207	162 - 209	167 - 210	171 - 209	175 - 208	

1. *** Adjustment RSS



BB









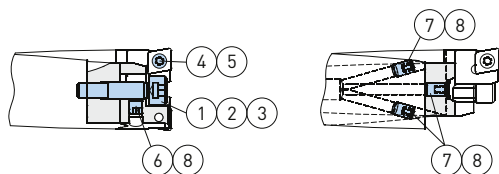

DP

Insert holders SW for back boring

Model	Order No.	Model	Order No.	Image	∅D	A	B	L1	L2
BB44-54SW32CC09	639.490	DP-SW32	639.913	CC09	44 - 54	31	D-17 / min. 31	24	38
BB53-66SW41CC09	639.491	DP-SW41	639.914		53 - 66	39	D-21 / min. 39	29	44
BB65-82SW53CC12	639.492	DP-SW53	639.915	CC12	65 - 82	50	D-28 / min. 50	34	55
BB81-103SW68CC12	639.493	DP-SW68	639.916		81 - 103	63.5	D-27 / min. 63.5	41	66
BB102-130SW98CC12	639.494	DP-SW98	639.917		102 - 130	90	90	38	69 / 78 / 108
BB129-157SW98CC12	639.495				129 - 157				
BB156-184SW148CC12	639.496	DP-SW148	639.918		156 - 184	140	140	38	69 / 108
BB183-211SW148CC12	639.497				183 - 211				



Rough boring heads MW

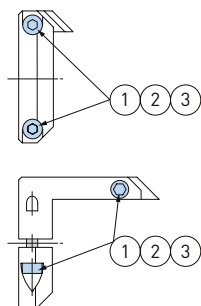

										
Typ	①	②	M [Nm] *	③	④ **	M [Nm] *	⑤	⑥ **	⑦ **	⑧
MW1619	690.159	693.186	1	690.802	694.105	0.3	694.806	690.413	690.668	690.833
MW1821	690.159	693.186	1	680.802	694.105	0.3	694.806	690.668	690.668	690.833

Clamp screws for chamfering rings



				
Typ	①	②	M [Nm] *	③
20	690.101	693.175	4.0	690.803
25	690.102	693.176	7.0	690.804
32	690.103	693.176	7.0	690.804
41	690.104	693.176	7.0	690.804
53	690.105	693.131	25.0	690.807
68	690.106	693.131	25.0	690.807
90	690.106	693.131	25.0	690.807

* M = Recommended torque for tightening the screws

** Per package: 10 screws and 1 wrench

Fine boring heads EWN, Series 112

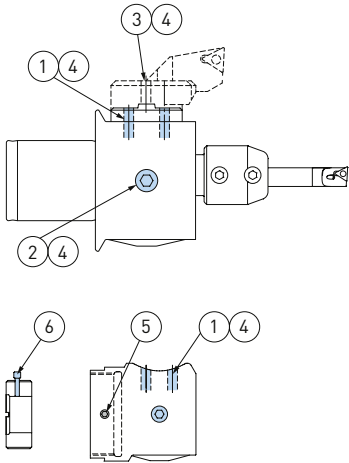

Type	①	M [Nm] *	②	M [Nm] *	③	M [Nm] *	④
EWN 04-7	690.538	0.8	690.978	0.8			690.800
EWN 04-12	690.417	1.2	690.417	1.2			690.811
EWN 04-15	690.440	1.5	690.418	1.5			690.812
EWN 04-22	690.421	2.5	690.489	2.5			690.813
EWN 2-32	690.460	5.0	690.449	5.0			690.814
EWN 2-152	690.595	10.0	690.452	10.0	690.156	12.0	690.816

Type	⑤	Type	⑥
EWN 04-22 x ES	690.417	112.271	195.003
		112.272	195.001
EWN 2-32 x ES	690.582	112.353	195.001
		112.385	195.007

Fine boring heads EWE, Series 112

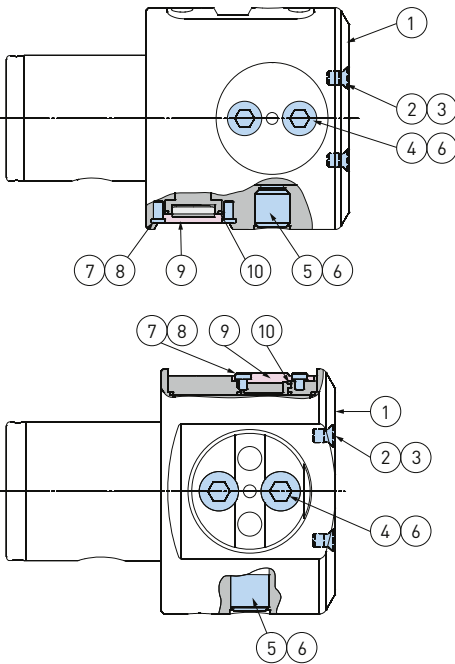

Type	①	②	③	④	M [Nm]	⑤	M [Nm]
EWE 2-152	112.804	690.614	690.843	690.457	10.0	690.995	10.0
EWE 2-32	112.371	690.611	690.836	690.460	5.0	690.996	5.0

Type	⑥	⑦	M [Nm]	⑧	⑨	⑩	⑧
EWE 2-152	690.816	690.326	1.0	395.170	395.161	694.808	694.808
EWE 2-32	690.814	690.326	1.0	395.170	395.161	694.808	694.808

Fine boring heads EWB, Series 112

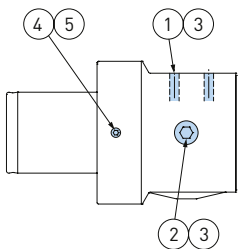

Type	①	M [Nm] *	②	M [Nm] *	③	④	M [Nm] *	⑤	
EWB 2-32	690.460	4.0	690.449	4.0	690.814	112.381	0.5	690.811	
EWB 2-50	690.457	8.0	690.452	8.0	690.816	690.208	1.5	690.812	

B.6

Reducers

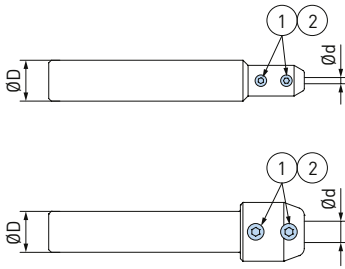

Type	Type			
Ø D - d	Ø D - d	①	M [Nm] *	②
12 - 3.5	16 - 3.5	690.459	0.5	690.801
12 - 4.0	16 - 4.0			
12 - 4.5	16 - 4.5			
12 - 5.0	16 - 5.0			
12 - 6.0	16 - 6.0			
	16 - 7.0	690.489	2.5	690.803
	16 - 8.0			
	16 - 9.0			
	16 - 10.0			

Tool holders

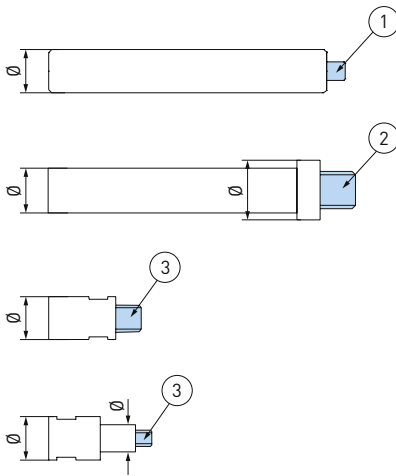

Ø	Type	G	
8	615.088	M5	690.486
	615.211		690.486
	615.212		690.486
10	615.089	M6	690.487A
	615.214		690.487A
	615.215		690.487A
	615.223		690.487A
11	615.250	M6	690.487A

Ø	Type	G	
12	615.218	M6	690.487A
	615.219		690.487A
	615.224		690.487A
	615.225		690.487A
	615.251		690.487A
13	615.251	M6	690.487A
14	615.232	M6	690.487A
16	615.226	M10	690.488

Type	Ø	G	
615.216	10 / 12	M6	690.487A
615.239	12 / 16	M10	690.488
615.240	12 / 16	M10	690.488
615.243	12 / 16	M10	690.488

Type	Ø	G	
615.220	12	M6	690.487A
615.230	16 / 10	M6	690.487A
615.231	16 / 12	M6	690.487A

Screws glued in with Locite 270 or Ergo 4101.

Clamp screws for inserts



Type	**	M [Nm] *	
WC 02	694.101	0.5	694.806

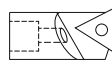

Type	**	M [Nm] *	
TP 07	694.102 ¹	0.5	694.806
TP 07	694.103	0.5	694.806

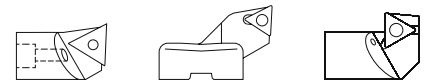

Type	**	M [Nm] *	
TC 11	694.122	0.7	694.807



Type	**	M [Nm] *	
CC 06	694.122	0.7	694.807
CC 09	694.141	3.0	694.815

¹ For Insert holder 615.086/615.207/615.087/615.205/615.271/615.507/615.508

* M = Recommended torque for tightening the screws

** Per package: 10 screws and 1 wrench

Adjustable tool holder

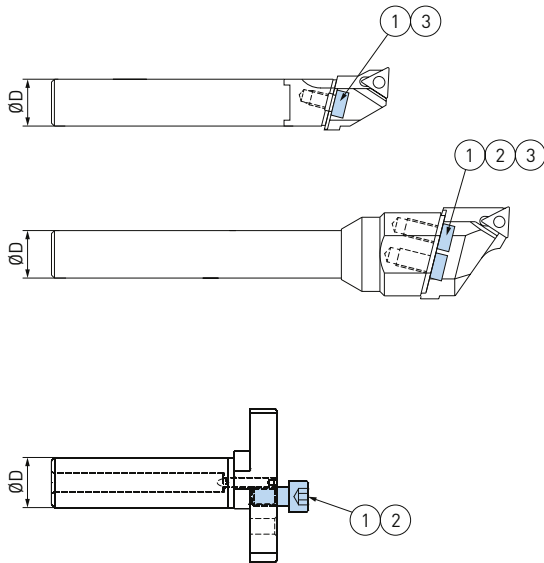

ØD	Type	①	②	M [Nm] *	③
9	615.369	690.323		1.0	690.837
	615.374	690.323		1.0	690.837
11	615.371	690.324		2.0	690.838
	615.375	690.324		2.0	690.838
13	615.376	690.324		2.0	690.838
	615.373	690.183		4.0	690.803
	615.377	690.183		4.0	690.803
16	615.378	690.183		4.0	690.803
	615.252	690.113		10.0	690.804
	615.253	690.113		10.0	690.804
	615.262	690.113		10.0	690.804
16	615.265	690.113		10.0	690.804
	615.266	690.113		10.0	690.804
	615.257	690.150	615.904	17.0	690.805
	615.258	690.150	615.904	17.0	690.805
16	615.264	690.150	615.904	17.0	690.805
	615.267	690.150	615.904	17.0	690.805
16	615.387B	690.107	693.182	12.0	690.805

Chamfering rings

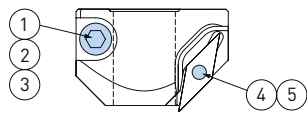

Type	①	②	M [Nm] *	③	④	M [Nm] *	⑤
615.394	690.157	693.181	10.0	690.814	VC 11	694.125	0.8
615.395							

* M = Recommended torque for tightening the screws

** Per package: 10 screws and 1 wrench

Fine boring heads EWN, Series 310

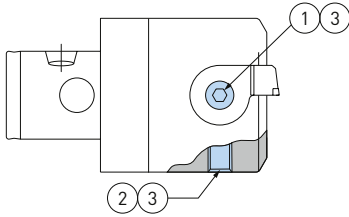

Type	①	M [Nm] *	②	M [Nm] *	③
EWN 20	690.135	1.0	690.410	0.5	690.811
EWN 25	690.136	1.0	690.549	0.5	690.811
EWN 32	690.137	2.5	690.550	1.5	690.812
EWN 41	690.138	3.0	690.551	2.5	690.813
EWN 53	690.139	6.0	690.552	6.0	690.814
EWN 68	690.141	12.0	690.553	10.0	690.816
EWN 100	690.141	12.0	690.553	10.0	690.816

Fine boring heads EWE, Series 310/318/BIG CAPTO

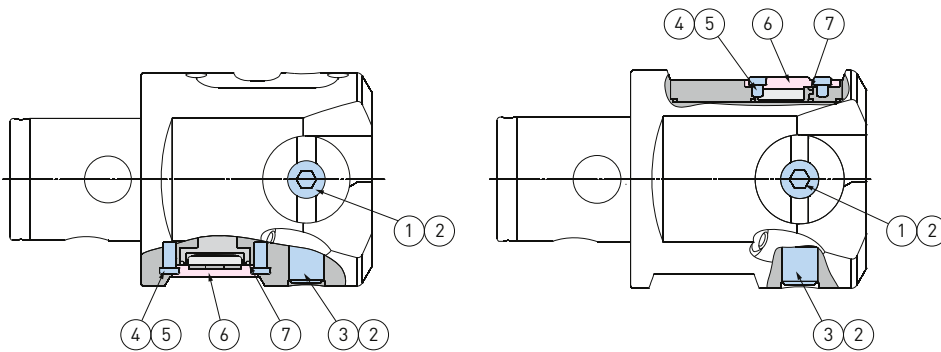

Type	①	M [Nm] *	③	M [Nm] *	②	④	M [Nm] *	⑤	⑥	⑦
EWE 41	690.138	3.0	690.997	2.5	690.813	690.326	1.0	694.808	395.170	395.161
EWE 53	690.139	6.0	690.996	6.0	690.814					
EWE 68	690.141	12.0	690.469	10.0	690.816					
EWE 100	690.141		690.553		690.816					
EWE 200	690.140		690.469		690.816					

B.6

Fine boring heads EWB, Series 310

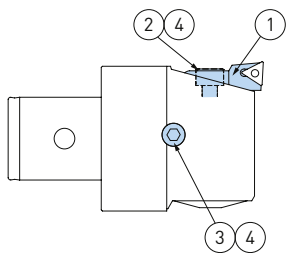





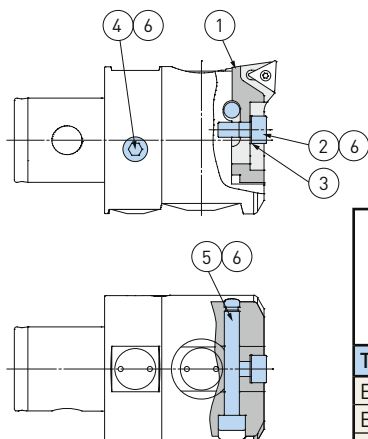

Type	①	②	M [Nm] *	③	M [Nm] *	④
EWB 32	626.231	690.137	2.5	690.577	2.5	690.812
EWB 41	626.241	690.138	3.0	690.578	3.0	690.813
EWB 53	626.251	690.139	6.0	690.579	6.0	690.814
EWB 68	626.261	690.140	12.0	690.580	12.0	690.816
EWB 85	626.261	690.140	12.0	690.580	12.0	690.816
EWB 100 AL	626.261	690.140	12.0	690.580	12.0	690.816
EWB 150 AL	626.261	690.140	12.0	690.580	12.0	690.816

* M = Recommended torque for tightening the screws





Fine boring heads EWB-UP, Series 309

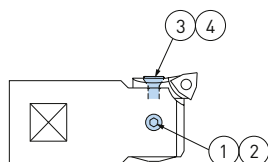

									
Type	①	②	③	M [Nm] *	④	M [Nm] *	⑤	M [Nm] *	⑥
EWB 25 UP	627.121	690.182	693.289	1.0		1.0	690.940	1.0	690.811
EWB 32 UP	627.131	690.179	693.186	1.5	690.550	1.5	690.180	1.5	690.812
EWB 41 UP	627.141	690.176	693.175	2.5	690.943	2.5	690.115	2.5	690.813
EWB 53 UP	627.151	690.177	693.176	4.0	690.658	4.0	690.178	4.0	690.814
EWB 68 UP	627.161	690.953	693.177	5.0	690.591	5.0	690.954	6.5	690.816



Boring heads with thread connection EW 15/EW 18, Series 310





						
Type	①	M [Nm] *	②	③ **	M [Nm] *	④
EW 15	690.414	0.5	690.819	694.120	1.2	694.807
EW 18	690.416	0.5	690.819	694.120	1.2	694.807

Clamp screws for inserts





			
Type	**	M [Nm] *	
WC 02	694.101	0.5	694.806



			
Type	**	M [Nm] *	
TP 07	694.103	0.5	694.806
TC 11	694.122	0.7	694.807



			
Type	**	M [Nm] *	
CC 06	694.122	0.7	694.807
CC 09	694.141	3.0	694.815

B.6

* M = Recommended torque for tightening the screws

** Per package: 10 screws and 1 wrench

Lightweight boring tools, Ø 200 - 620 mm, Series 318

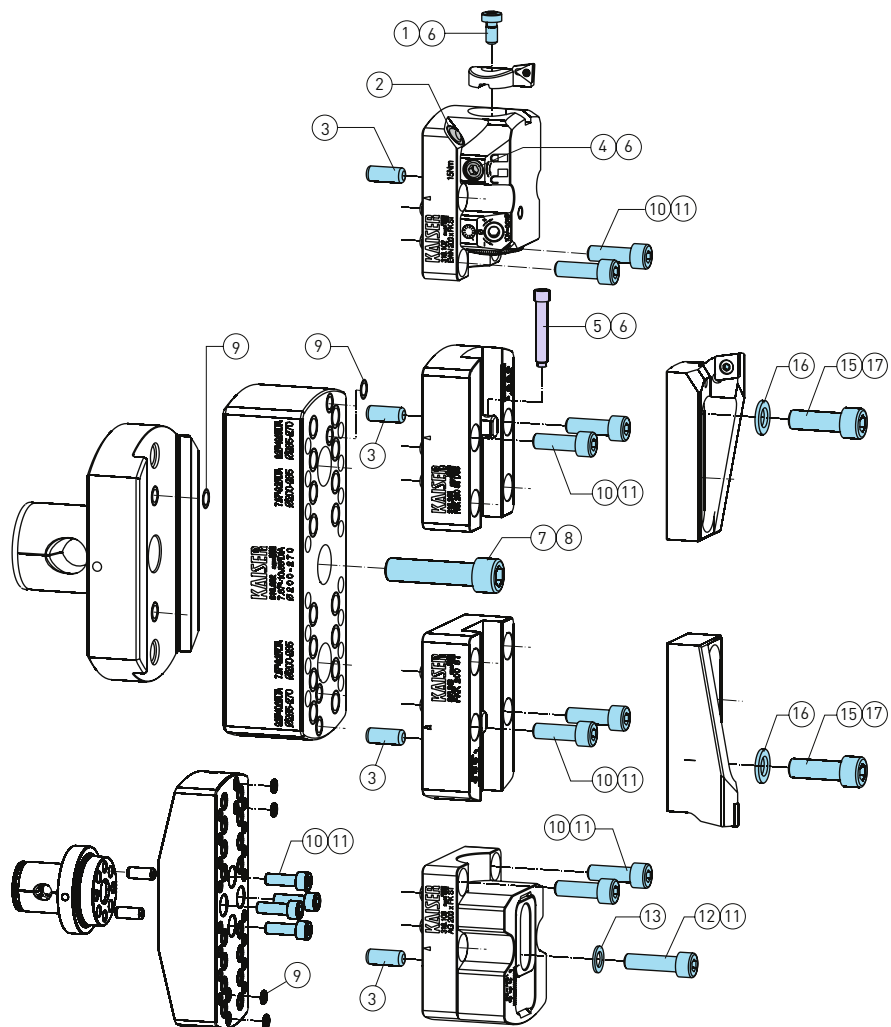

①	M [Nm] *	②	③
690.140	12.0	692.406	691.390
④	M [Nm] *	⑤	⑥
690.553	10.0	317.193	690.816
⑦	M [Nm] *	⑧	⑨
690.121	45.0	690.808	692.295
⑩	M [Nm] *	⑪	
690.163	20.0	690.806	
⑫	⑬	M [Nm] *	⑪
690.124	693.183	15.0	690.806
⑮	⑯	M [Nm] *	⑰
690.105	693.184	30.0	690.807

Coolant pipe, series 318

Model	Order No.
CP-DM5-50-M5	692.415

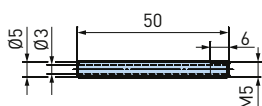

B.6

Clamp screws for inserts

Type	**	M [Nm] *	
CC 12	694.150	5.0	694.820
CC 16	694.150	5.0	694.820

Type	**	M [Nm] *	
SC 12	694.144	5.0	694.820

Type	**	M [Nm] *	
WC 08	694.143	3.0	694.815

Type	**	M [Nm] *	
TC 11	694.122	0.7	694.807

* M = Recommended torque for tightening the screws

**Per package: 10 screws and 1 wrench

OD turning / Eccentric bar

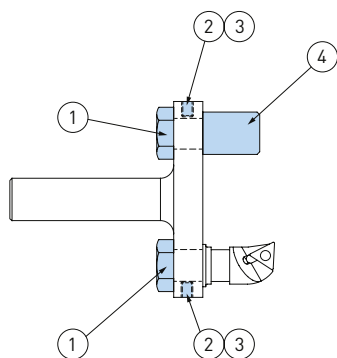

Type	①	②	③	④
	615.390	690.716	690.573	690.813

Face grooving holder SW, Series 318

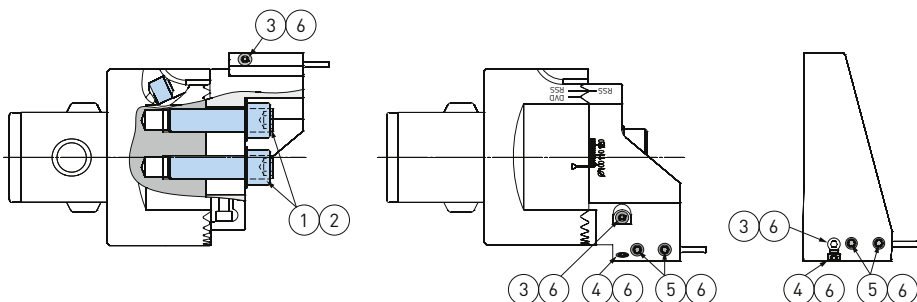

Type	①	M [Nm] *	②	③	④	⑤	M [Nm] *	⑥
SW53	639.691	16	690.805	639.690	690.400	690.511	2.5	690.813
SW68	639.691	16	690.805	639.690	690.400	690.622	2.5	690.813
SW98xCKN6	639.693	20	690.806	639.690	690.400	690.912	2.5	690.813
SW98xCKN7	639.693	20	690.806	639.690	690.400	690.912	2.5	690.813
SW148xCKN6	639.693	20	690.806	639.690	690.400	690.913	2.5	690.813
SW148xCKN7	639.693	20	690.806	639.690	690.400	690.913	2.5	690.813
FKW200 [Serie 318]	-	-	-	637.962	690.400	690.511	2.5	690.813

B.6



Face grooving holder / Blind Piece



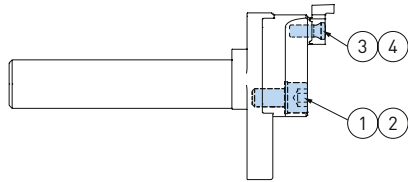
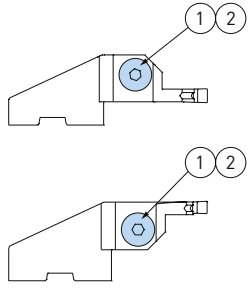

Type	ØD			
SW53	53 - 70	639.651	639.652	639.915
SW68	68 - 90	639.661	639.662	639.916
	88 - 110	639.665	639.666	
SW98	98 - 126	639.671	639.672	639.917
	125 - 153	639.675	639.676	
SW148	148 - 176	639.681	639.682	639.918
	175 - 203	639.685	639.686	

* M = Recommended torque for tightening the screws

Insert holders for face grooving





Type	Type		M [Nm] *	
626.935	626.945	①	4.0	②
626.936	626.946			
626.937	626.947			
626.938	626.948			

Type			M [Nm] *		M [Nm] *	
615.387	①	②	12.0	③ **	3.0	④
615.388						

Slot milling cutters

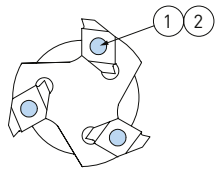
Clamp screws for inserts



Type		M [Nm] *	
0	① **	0.8	②
1	958.048	0.8	690.836
2	958.049	6.0	690.838

* M = Recommended torque for tightening the screws

** Per package: 10 screws and 1 wrench

Drill chuck

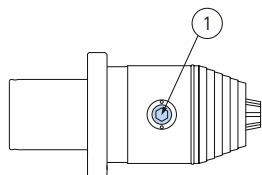

Type	①	M [Nm] *
335.042	690.817	20
335.044	690.817	20

End mill holders

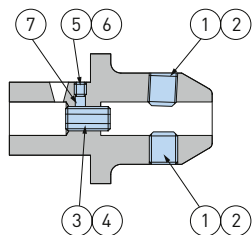

Type	①	M [Nm] *	②	③	④	⑤	⑥	⑦
6	690.477	5	690.803	690.512	690.802	690.419	690.802	691.318
8	690.478	10	690.804	690.513	690.803	690.489	690.803	691.316
10	690.479	16	690.805	690.514	690.804	690.489	690.803	691.316
12	690.480	28	690.806	690.515	690.805	690.489	690.803	691.315
14	690.480	28	690.806	690.515	690.805	690.489	690.803	691.315
16	690.481	28	690.806	690.510	690.806	690.489	690.803	691.315
18	690.481	28	690.806	690.510	690.806	690.489	690.803	691.315
20	690.482	42	690.807	690.510	690.806	690.489	690.803	691.315
25	690.483	50	690.810	690.510	690.806	690.489	690.803	691.315
32	690.484	72	690.810					
40	690.484	72	690.810					

Universal milling cutter holders

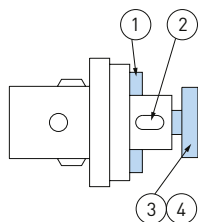

Type	①	②	③	M [Nm] *	④
16	691.605	691.600	690.703	18	690.805
22	691.606	691.601	690.704	35	690.806
27	691.607	691.602	690.705	70	690.807
32	691.608	691.604	690.706	80	690.810
40	691.609	691.603	690.707	80	690.809

B.6

* M = Recommended torque for tightening the screws

Clamp screws and wrenches for inserts

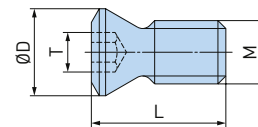

Screws

Insert type	Dimensions				Nm ¹	Torx	Torx Plus	Note
	Torx/Torx Plus	Thread M	ØD	L		Order No.	Order No.	
WC02	T6 IP	M2	2.7	3.6	0.5		694.101	Only for use with insert holders: 615.205/615.207/615.508/615.271
TP07	T6 IP	M2	2.7	4.1			694.102	
TP07	T6 IP	M2	2.7	4.8			694.103	
WC03	T7 IP	M2.2	3.5	6.0	0.7		694.110	
TC11	T7 IP	M2.5	3.5	6.5			694.122	
WP337-1	T7 IP	M2.5	3.5	5.8			694.123	
WC04	T7 IP	M2.5	3.5	6.3			694.124	
SP08	T7 IP	M2.5	4.3	5.5			694.121	
WP337-2	T7 IP	M3	4.6	6.0	0.8		694.130	Grooving Insert BIG KAISER Original
DN0 / DN01	T8	M3	4.4	9.0		958.048		
VC11	T8 IP	M2.5	3.5	8.7	1.5		694.125	
WC05	T9 IP	M3	4.4	8.2			694.131	
WC06	T10 IP	M3.5	4.8	9.2			694.137	
WP337-3	T10 IP	M3.5	5.5	8.2	1.8		694.136	
WC08	T15	M4	5.7	8.2			336.905	
CC09	T15 IP	M4	5.1	9.2	3.0		694.141	Grooving Insert BIG KAISER Original
RD14	T15 IP	M4	5.5	11.8			694.143	
DN2	T20	M5	6.6	16.5	6.0		958.049	Grooving Insert BIG KAISER Original
SC12	T20 IP	M4	6.5	11.6			694.142	
CC12	T20 IP	M5	7.0	13.3			694.150	

1. The clamping screws for the inserts are supplied in packages of 10 pieces with a corresponding wrench.

Wrench

B.6

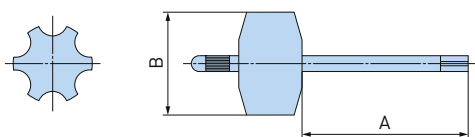

Dimensions		Torx	Torx Plus
Torx/Torx Plus	A	Order No.	Order No.

Compatibility TORX - TORX PLUS

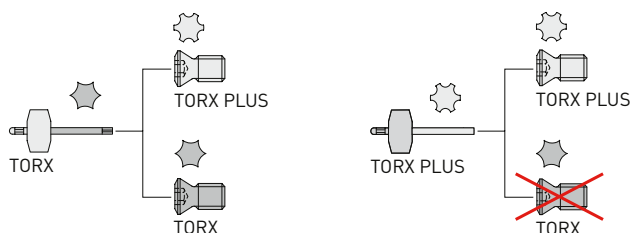

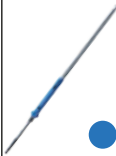

T6	42	26	690.834	
T6 IP				694.806
T7 IP				694.807
T8	50	34	690.836	
T8 IP				694.808
T9 IP				694.809
T10				690.837
T10 IP				694.810
T15	50	34	690.843	
T15 IP				694.815
T20				690.838
T20 IP				694.820

Torque Wrench

Size	Torque	Torque Wrench	Torx Blade	Set
				
Torx 6	0.5 Nm	694.160	694.167	694.181
Torx 7	0.7 Nm	694.161	694.168	694.182
Torx 8	0.8 Nm	694.162	694.169	694.183
Torx 9	1.5 Nm	694.163	694.170	694.184
Torx 10	1.8 Nm	694.164	694.171	694.185
Torx 15	3.0 Nm	694.165	694.172	694.186
Torx 20	5.0 Nm	694.166	694.173	694.187

Torx Plus Wrench

Size	Torque	Torque Wrench	Torx Plus Blade	Set
				
Torx 6	0.5 Nm	694.160	694.174	694.188
Torx 7	0.7 Nm	694.161	694.175	694.189
Torx 8	0.8 Nm	694.162	694.176	694.190
Torx 9	1.5 Nm	694.163	694.177	694.191
Torx 10	1.8 Nm	694.164	694.178	694.192
Torx 15	3.0 Nm	694.165	694.179	694.193
Torx 20	5.0 Nm	694.166	694.180	694.194

1. Maximum tightening torque

Wrenches

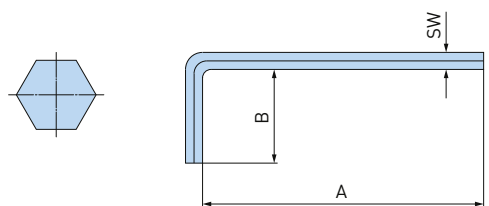
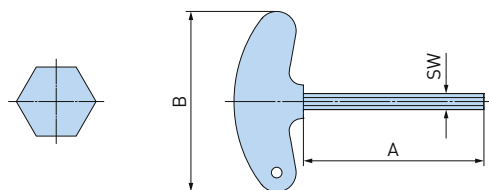

A	B	SW	Order No.
50	45	1.5	690.819
		2	690.811
		2.5	690.812
		3	690.813
70	65	4	690.814
		5	690.816
		6	690.817

A	B	SW	Order No.
42	14	1.3	690.833
50		1.5	690.800
50	16	2	690.801
56	18	2.5	690.802
63	20	3	690.803
67	24	3.5	690.899
71	25	4	690.804
80	28	5	690.805
90	32	6	690.806
100	36	8	690.807
112	40	10	690.810
200		12	690.808
125	45	12	690.809
140	56	14	690.832
140	63	17	690.861

B.6

Indexable End Mills

Fullcut Mill FCM	518
Fullcut Mill FCM Arbor Type	527
Fullcut Mill FCM Inserts	528
Fullcut Mill FCR	531
Fullcut Mill FCR Inserts	537
Spare Parts	540
Surface Mill	541
Speed Finisher	542



Fullcut Mill FCM - For Standard Type with BBT

The indexable endmill that combines sharpness and rigidity for best results.

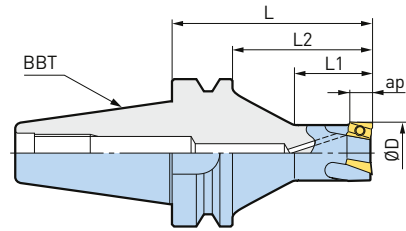
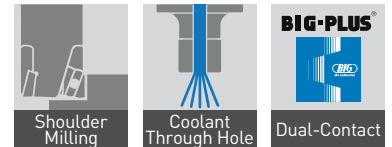





Model	Order No.	ØD	L	L1	L2	ap	Number of Inserts	Insert size
BBT30-FCM16092-65	966.216	16	65	23	43	9	2	ARG16
BBT30-FCM20093-65	966.217	20	65	28	43	9	3	ARG20
BBT30-FCM25093-65	966.218	25	65	33	43	9	3	ARG25
BBT30-FCM25093-105	100644.001.0	25	105	34	83	9	3	ARG25
BBT30-FCM32113-65	966.219	32	65	38	43	11	3	ARG32
BBT30-FCM32113-105	100644.002.0	32	105	44	83	11	3	ARG32
BBT30-FCM40114-50	966.220	40	50	25	28	11	4	ARG40
BBT30-FCM50115-50	966.120	50	50	28	28	11	5	ARG40
BBT40-FCM16092-85	966.221	16	85	23	58	9	2	ARG16
BBT40-FCM16092-105	966.121	16	105	30	78	9	2	ARG16
BBT40-FCM16092-120	966.122	16	120	25	93	9	2	ARG16
BBT40-FCM16092-150	966.123	16	150	25	123	9	2	ARG16
BBT40-FCM20093-85	966.222	20	85	28	58	9	3	ARG20
BBT40-FCM20093-105	966.124	20	105	35	78	9	3	ARG20
BBT40-FCM20093-120	966.125	20	120	30	93	9	3	ARG20
BBT40-FCM20093-150	966.126	20	150	30	123	9	3	ARG20
BBT40-FCM25093-85	966.223	25	85	33	58	9	3	ARG25
BBT40-FCM25093-120	966.127	25	120	45	93	9	3	ARG25
BBT40-FCM25093-135	966.128	25	135	40	108	9	3	ARG25
BBT40-FCM25093-165	966.129	25	165	40	138	9	3	ARG25
BBT40-FCM32113-85	966.224	32	85	38	58	11	3	ARG32
BBT40-FCM32113-120	966.130	32	120	60	93	11	3	ARG32
BBT40-FCM32113-135	966.131	32	135	50	108	11	3	ARG32
BBT40-FCM32113-165	966.132	32	165	40	138	11	3	ARG32
BBT40-FCM40114-85	966.225	40	85	43	58	11	4	ARG40
BBT40-FCM40114-120	966.133	40	120	65	93	11	4	ARG40
BBT40-FCM40114-135	966.134	40	135	60	108	11	4	ARG40
BBT40-FCM40114-165	966.135	40	165	50	138	11	4	ARG40
BBT40-FCM50115-70	966.226	50	70	38	43	11	5	ARG40
BBT40-FCM50115-120	966.136	50	120	65	93	11	5	ARG40
BBT40-FCM50115-135	966.137	50	135	60	108	11	5	ARG40
BBT40-FCM50115-165	966.138	50	165	50	138	11	5	ARG40

C.1

1. BIG-PLUS® tools can be used in machining centers with non BIG-PLUS® spindles.
2. Wrench is included.
3. Inserts are to be ordered separately.

Accessories & Spare Parts

<p>Adapter for BBT50 taper shank</p>  <p>► 519</p>	<p>Indexable Inserts for Fullcut Mill FCM</p>  <p>► 528</p>	<p>Wrench</p>  <p>► 540</p>	<p>Insert Clamping Screw Set</p>  <p>► 540</p>
---	--	--	---

Fullcut Mill FCM - For Long Nose Type with BBT

The indexable endmill that combines sharpness and rigidity.

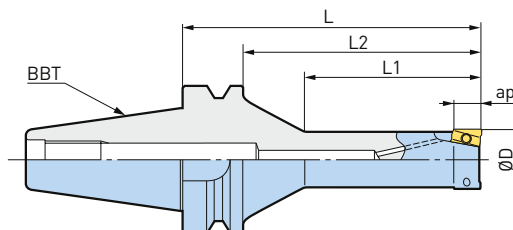
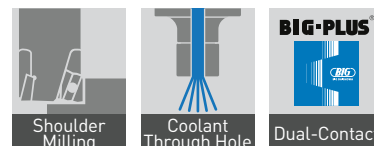

Model	Order No.	ØD	L	L1	L2	ap	Number of Inserts	Insert size
BBT30-FCM16092L-85	966.081	16	85	45	63	9	2	ARG16
BBT30-FCM20092L-85	966.082	20	85	50	63	9	2	ARG20
BBT30-FCM25092L-85	966.083	25	85	50	63	9	2	ARG25
BBT30-FCM32112L-85	966.084	32	85	60	63	11	2	ARG32
BBT40-FCM16092L-105	966.085	16	105	45	78	9	2	ARG16
BBT40-FCM16092L-120	966.086	16	120	45	93	9	2	ARG16
BBT40-FCM20092L-120	966.087	20	120	60	93	9	2	ARG20
BBT40-FCM20092L-135	966.088	20	135	60	108	9	2	ARG20
BBT40-FCM25092L-135	966.089	25	135	75	108	9	2	ARG25
BBT40-FCM25092L-150	966.090	25	150	75	123	9	2	ARG25
BBT40-FCM32112L-135	966.091	32	135	80	108	11	2	ARG32
BBT40-FCM32112L-150	966.092	32	150	90	123	11	2	ARG32

1. BIG-PLUS® tools can be used in machining centers with non BIG-PLUS® spindles.
2. Wrench is included.
3. Inserts are to be ordered separately.





Adapter for BBT50 taper shank



Model	Order No.	L
BBT50-BBT40-50	803.730	50
BBT50-BBT40-90	803.731	90

C.1

Accessories & Spare Parts

<p>Adapter for BBT50 taper shank</p>  <p>► 519</p>	<p>Indexable Inserts for Fullcut Mill FCM</p>  <p>► 528</p>	<p>Wrench</p>  <p>► 540</p>	<p>Insert Clamping Screw Set</p>  <p>► 540</p>
---	--	--	---

Fullcut Mill FCM - For Standard Type with BDV

The indexable endmill that combines sharpness and rigidity.

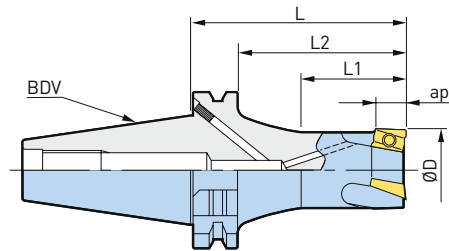

Model	Order No.	ØD	L	L1	L2	ap	Number of Inserts	Insert size
BDV40-FCM16092-85	966.206	16	85	23	65	9	2	ARG16
BDV40-FCM16092-105	966.161	16	105	35	85	9	2	ARG16
BDV40-FCM16092-120	966.162	16	120	34	100	9	2	ARG16
BDV40-FCM20093-85	966.207	20	85	35	65	9	3	ARG20
BDV40-FCM20093-105	966.163	20	105	40	85	9	3	ARG20
BDV40-FCM20093-120	966.164	20	120	39	100	9	3	ARG20
BDV40-FCM25093-85	966.208	25	85	33	65	9	3	ARG25
BDV40-FCM25093-120	966.165	25	120	45	100	9	3	ARG25
BDV40-FCM25093-135	966.166	25	135	40	115	9	3	ARG25
BDV40-FCM32113-85	966.209	32	85	38	65	11	3	ARG32
BDV40-FCM32113-120	966.167	32	120	60	100	11	3	ARG32
BDV40-FCM32113-135	966.168	32	135	50	115	11	3	ARG32
BDV40-FCM40114-85	966.210	40	85	45	65	11	4	ARG40
BDV40-FCM40114-120	966.169	40	120	65	100	11	4	ARG40
BDV40-FCM40114-135	966.170	40	135	60	115	11	4	ARG40
BDV40-FCM50115-70	966.211	50	70	50	50	11	5	ARG40
BDV40-FCM50115-120	966.171	50	120	100	100	11	5	ARG40
BDV40-FCM50115-135	966.172	50	135	115	115	11	5	ARG40

1. BIG-PLUS® tools can be used in machining centers with non BIG-PLUS® spindles.
2. Wrench is included.
3. Inserts are to be ordered separately.

Adapter for BDV50 taper shank

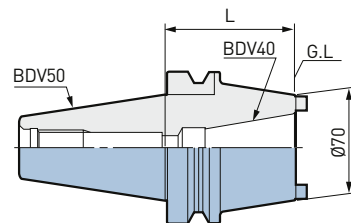
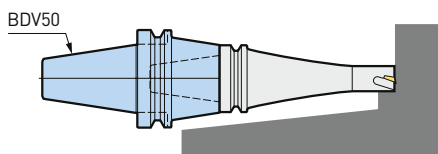



C.1

Model	Order No.	L
BDV50-BDV40-50	805.856	50

1. Combination with the 'long type' provides further reduction of interference contour.

Accessories & Spare Parts

<p>Indexable Inserts for Fullcut Mill FCM</p>  <p>► 528</p>	<p>Wrench</p>  <p>► 540</p>	<p>Insert Clamping Screw Set</p>  <p>► 540</p>
--	--	---

Fullcut Mill FCM - For Standard Type with HSK-A

The indexable endmill that combines sharpness and rigidity.

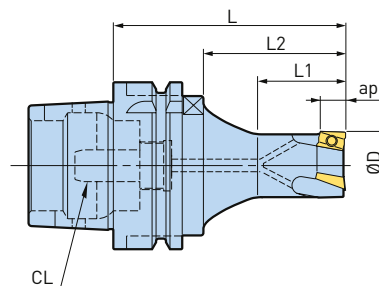
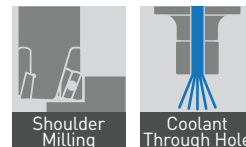

Model	Order No.	ØD	L	L1	L2	ap	Number of Inserts	Insert size
HSK-A40-FCM16092-65	966.101	16	65	23	37	9	2	ARG16
HSK-A40-FCM20093-65	966.102	20	65	28	37	9	3	ARG20
HSK-A40-FCM25093-65	966.103	25	65	35	37	9	3	ARG25
HSK-A40-FCM32113-65	966.104	32	65	35	37	11	3	ARG32
HSK-A40-FCM40114-65	966.105	40	65	45	-	11	4	ARG40
HSK-A40-FCM50115-65	966.106	50	65	45	-	11	5	ARG40
HSK-A50-FCM16092-75	966.107	16	75	23	41	9	2	ARG16
HSK-A50-FCM20093-75	966.108	20	75	28	41	9	3	ARG20
HSK-A50-FCM25093-75	966.109	25	75	33	41	9	3	ARG25
HSK-A50-FCM32113-75	966.110	32	75	39	41	11	3	ARG32
HSK-A50-FCM40114-75	966.111	40	75	48	-	11	4	ARG40
HSK-A50-FCM50115-75	966.112	50	75	48	-	11	5	ARG40
HSK-A63-FCM16092-85	966.231	16	85	23	51	9	2	ARG16
HSK-A63-FCM16092-105	966.141	16	105	30	71	9	2	ARG16
HSK-A63-FCM16092-120	966.142	16	120	25	86	9	2	ARG16
HSK-A63-FCM16092-150	966.143	16	150	25	116	9	2	ARG16
HSK-A63-FCM20093-85	966.232	20	85	28	51	9	3	ARG20
HSK-A63-FCM20093-105	966.144	20	105	35	71	9	3	ARG20
HSK-A63-FCM20093-120	966.145	20	120	30	86	9	3	ARG20
HSK-A63-FCM20093-150	966.146	20	150	30	116	9	3	ARG20
HSK-A63-FCM25093-85	966.233	25	85	33	51	9	3	ARG25
HSK-A63-FCM25093-120	966.147	25	120	45	86	9	3	ARG25
HSK-A63-FCM25093-135	966.148	25	135	40	101	9	3	ARG25
HSK-A63-FCM25093-165	966.149	25	165	40	131	9	3	ARG25
HSK-A63-FCM32113-85	966.234	32	85	38	51	11	3	ARG32
HSK-A63-FCM32113-120	966.150	32	120	60	86	11	3	ARG32
HSK-A63-FCM32113-135	966.151	32	135	50	101	11	3	ARG32
HSK-A63-FCM32113-165	966.152	32	165	40	131	11	3	ARG32
HSK-A63-FCM40114-85	966.235	40	85	43	51	11	4	ARG40
HSK-A63-FCM40114-120	966.153	40	120	65	86	11	4	ARG40
HSK-A63-FCM40114-135	966.154	40	135	60	101	11	4	ARG40
HSK-A63-FCM40114-165	966.155	40	165	50	131	11	4	ARG40
HSK-A63-FCM50115-70	966.236	50	70	28	28	11	5	ARG40
HSK-A63-FCM50115-120	966.156	50	120	78	78	11	5	ARG40
HSK-A63-FCM50115-135	966.157	50	135	93	93	11	5	ARG40
HSK-A63-FCM50115-165	966.158	50	165	123	123	11	5	ARG40

1. Coolant pipe (CL) and inserts are to be ordered separately.
2. Wrench is included.

Accessories & Spare Parts

<p>Indexable Inserts for Fullcut Mill FCM</p> <p>► 528</p>	<p>Coolant Pipes</p> <p>► 228</p>	<p>Wrench</p> <p>► 540</p>	<p>Insert Clamping Screw Set</p> <p>► 540</p>
---	--	-----------------------------------	--

C.1

Fullcut Mill FCM - For Long Nose Type with HSK-A

The indexable endmill that combines sharpness and rigidity.

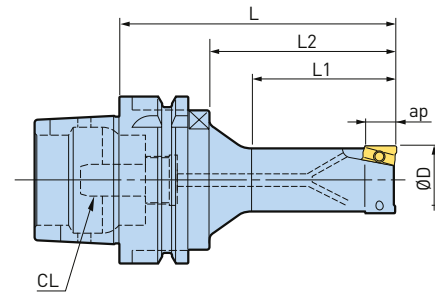
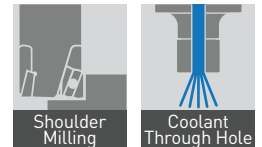





Model	Order No.	ØD	L	L1	L2	ap	Number of Inserts	Insert size
HSK-A63-FCM16092L-85	966.093	16	85	40	51	9	2	ARG16
HSK-A63-FCM16092L-120	966.094	16	120	45	86	9	2	ARG16
HSK-A63-FCM20092L-105	966.095	20	105	50	71	9	2	ARG20
HSK-A63-FCM20092L-120	966.096	20	120	60	86	9	2	ARG20
HSK-A63-FCM25092L-105	966.097	25	105	55	71	9	2	ARG25
HSK-A63-FCM25092L-120	966.098	25	120	65	86	9	2	ARG25
HSK-A63-FCM32112L-120	966.099	32	120	70	86	11	2	ARG32
HSK-A63-FCM32112L-135	966.100	32	135	80	101	11	2	ARG32

1. Coolant pipe (CL) and inserts are to be ordered separately.
2. Wrench is included.

C.1

Accessories & Spare Parts

<p>Indexable Inserts for Fullcut Mill FCM</p>  <p>► 528</p>	<p>Coolant Pipes</p>  <p>► 228</p>	<p>Wrench</p>  <p>► 540</p>	<p>Insert Clamping Screw Set</p>  <p>► 540</p>
--	---	--	---

Fullcut Mill FCM - For Standard Type with HSK-E

The indexable endmill that combines sharpness and rigidity.

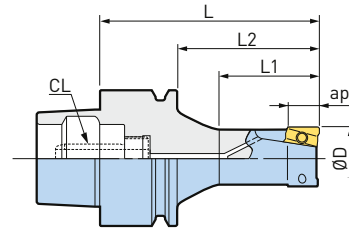
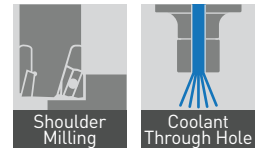

Model	Order No.	ØD	L	L1	L2	ap	Number of Inserts	Insert size
HSK-E25-FCM16092-45	966.173	16	45	23	35	9	2	ARG16
HSK-E32-FCM16092-55	966.174	16	55	23	35	9	2	ARG16
HSK-E40-FCM16092-65	966.115	16	65	28	45	9	2	ARG16

1. Coolant pipe (CL) and inserts are to be ordered separately.
2. Wrench is included.

Accessories & Spare Parts

<p>Indexable Inserts for Fullcut Mill FCM</p> <p>► 528</p>	<p>Coolant Pipes</p> <p>► 228</p>	<p>Wrench</p> <p>► 540</p>	<p>Insert Clamping Screw Set</p> <p>► 540</p>
--	-----------------------------------	----------------------------	---

Fullcut Mill FCM - For Standard Type with BIG CAPTO

The indexable endmill that combines sharpness and rigidity.

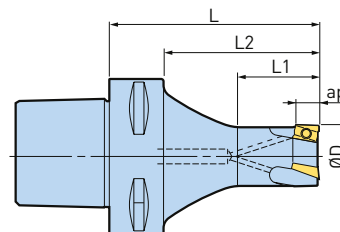
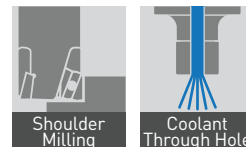

Model	Order No.	ØD	L	L1	L2	ap	Number of Inserts	Insert size
C5-FCM16092-65	805.858	16	65	23	45	9	2	ARG16
C5-FCM16092-90	805.859	16	90	30	70	9	2	ARG16
C5-FCM20093-65	973.609	20	65	28	45	9	3	ARG20
C5-FCM20093-90	805.860	20	90	35	70	9	3	ARG20
C5-FCM25093-65	805.861	25	65	33	45	9	3	ARG25
C5-FCM25093-90	805.862	25	90	40	70	9	3	ARG25
C5-FCM32113-65	805.863	32	65	38	45	11	3	ARG32
C5-FCM32113-90	805.864	32	90	45	70	11	3	ARG32
C5-FCM40114-50	805.865	40	50	25	30	11	4	ARG40
C5-FCM40114-90	805.866	40	90	60	70	11	4	ARG40
C5-FCM50115-50	805.867	50	50	25	30	11	5	ARG40
C5-FCM50115-90	805.868	50	90	65	70	11	5	ARG40
C6-FCM16092-85	100650.001.0	16	85	24	63	9	2	ARG16
C6-FCM16092-110	100650.002.0	16	110	30	88	9	2	ARG16
C6-FCM16092-135	100650.003.0	16	135	27	113	9	2	ARG16
C6-FCM20093-85	100650.004.0	20	85	28	63	9	3	ARG20
C6-FCM20093-110	100650.005.0	20	110	34	88	9	3	ARG20
C6-FCM20093-135	100650.006.0	20	135	32	113	9	3	ARG20
C6-FCM25093-85	100650.007.0	25	85	33	63	9	3	ARG25
C6-FCM25093-110	100650.008.0	25	110	47	88	9	3	ARG25
C6-FCM25093-135	100650.009.0	25	135	44	113	9	3	ARG25
C6-FCM32113-85	100650.010.0	32	85	38	63	11	3	ARG32
C6-FCM32113-110	100650.011.0	32	110	61	88	11	3	ARG32
C6-FCM32113-135	100650.012.0	32	135	54	113	11	3	ARG32
C6-FCM40114-85	100650.013.0	40	85	44	63	11	4	ARG40
C6-FCM40114-110	100650.014.0	40	110	65	88	11	4	ARG40
C6-FCM40114-135	100650.015.0	40	135	61	113	11	4	ARG40
C6-FCM50115-70	100650.016.0	50	70	43	48	11	5	ARG40
C6-FCM50115-110	100650.017.0	50	110	70	88	11	5	ARG40
C6-FCM50115-135	100650.018.0	50	135	72	113	11	5	ARG40

C.1

1. Wrench is included.
2. Inserts are to be ordered separately.

Accessories & Spare Parts

<p>Indexable Inserts for Fullcut Mill FCM</p> <p>► 528</p>	<p>Wrench</p> <p>► 540</p>	<p>Insert Clamping Screw Set</p> <p>► 540</p>
--	----------------------------	---

Fullcut Mill FCM - For Long Nose Type

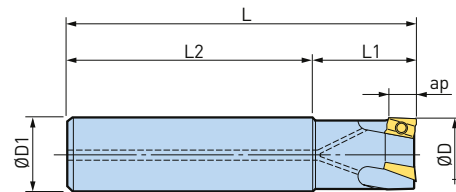
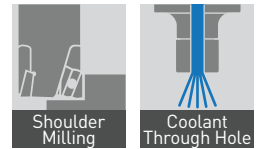

The indexable endmill that combines sharpness and rigidity.



Model	Order No.	ØD	ØD1	L	L1	L2	ap	Number of Inserts	Insert size
ST16-FCM12091-90	966.237	12	16	90	15	70	9	1	ARG16
ST16-FCM14091-90	966.238	14	16	90	17	70	9	1	ARG16
ST16-FCM16092-90	966.239	16	16	90	25	65	9	2	ARG16
ST20-FCM20093-110	966.240	20	20	110	30	80	9	3	ARG20
ST25-FCM25093-120	966.241	25	25	120	35	85	9	3	ARG25
ST32-FCM32113-130	966.242	32	32	130	35	95	11	3	ARG32
ST32-FCM40114-130	966.243	40	32	130	40	90	11	4	ARG40
ST32-FCM40114-180	802.963	40	32	180	40	140	11	4	ARG40
ST32-FCM50115-130	966.244	50	32	130	40	90	11	5	ARG40

1. Wrench is included.
2. Inserts are to be ordered separately.

Accessories & Spare Parts

<p>Indexable Inserts for Fullcut Mill FCM</p>  <p>► 528</p>	<p>Wrench</p>  <p>► 540</p>	<p>Insert Clamping Screw Set</p>  <p>► 540</p>
--	--	---

Fullcut Mill FCM - For Oversize Type

"Thin wall" at deep pocket & deep shoulder endmilling.

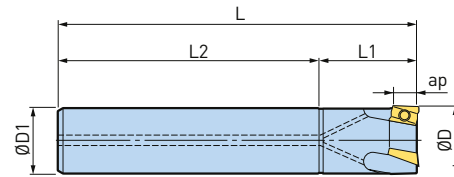
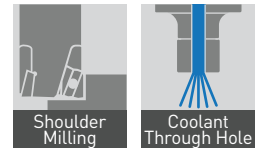

Model	Order No.	$\varnothing D$	$\varnothing D_1$	L	L1	L2	a_p	Number of Inserts	Insert size
ST15-FCM16092-120	807.455	16	15	120	25	95	9	2	ARG16
ST16-FCM17092-120	966.181	17	16	120	25	95	9	2	ARG16
ST19-FCM20092-165	807.456	20	19	165	30	135	9	2	ARG20
ST19-FCM20093-135	807.457	20	19	135	30	105	9	3	ARG20
ST20-FCM21092-165	966.182	21	20	165	30	135	9	2	ARG20
ST20-FCM21093-135	966.183	21	20	135	30	105	9	3	ARG20
ST24-FCM25092-180	807.458	25	24	180	35	145	9	2	ARG25
ST24-FCM25093-150	807.459	25	24	150	35	115	9	3	ARG25
ST25-FCM26092-165	966.184	26	25	165	38	127	9	2	ARG25
ST25-FCM26093-150	966.185	26	25	150	38	112	9	3	ARG25
ST28-FCM32112-180	807.460	32	28	180	48	132	11	2	ARG32
ST28-FCM32113-180	807.461	32	28	180	48	132	11	3	ARG32
ST32-FCM33112-180	966.186	33	32	180	48	132	11	2	ARG32
ST32-FCM33113-180	966.187	33	32	180	48	132	11	3	ARG32

1. Wrench is included.
2. Inserts are to be ordered separately.
3. For medium-heavy or heavy slot milling with projection longer than 2.5 times of diameter, 2-flutes models are recommended.

Application Example

Model	ST32-FCM33112-180
Material	C55 (S55C)
Cutting Speed V_c (m/min.)	120
Feed Rate f_z (mm/tooth)	0.1
Axial DOC a_p (mm)	10 mm x 10 steps
Radial DOC a_e (mm)	Max. 33 mm

Result

Deep shoulder endmilling is achieved with 110 mm projection length and 10 mm axial depth.

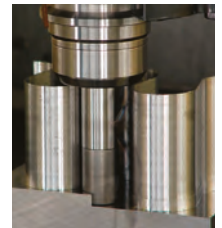

C.1

Accessories & Spare Parts

<p>Indexable Inserts for Fullcut Mill FCM</p> <p>► 528</p>	<p>Wrench</p> <p>► 540</p>	<p>Insert Clamping Screw Set</p> <p>► 540</p>
--	----------------------------	---

Fullcut Mill FCM - Arbor Type

Corresponding to Form FMH of new standard face milling adapter.

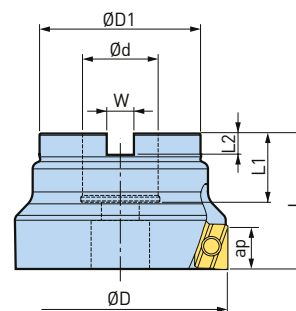

Model	Order No.	ØD	Ød	ØD1	L	L1	L2	ap	W	Number of Inserts	Insert size
FMH22-FCM50115-40	966.212	50	22	47	40	20	6	11	10.4	5	ARG40
FMH22-FCM63116-40	966.213	63	22	47	40	20	6	11	10.4	6	ARG63
FMH27-FCM80116-50	966.214	80	27	60	50	22	7	11	12.4	6	ARG80
FMH27-FCM100116-50	805.461	100	27	76	50	22	7	11	12.4	6	ARG80

1. Wrench is included.
2. Inserts are to be ordered separately.

Application Example

Indexable Insert Endmill, achieving the excellent squareness and fine surface finish

Machined by Fullcut Mill model: FMH22-FCM63116-40

Arbor model: BBT40-FMH22-47-45

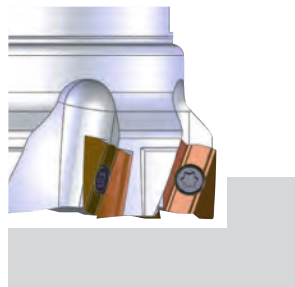

Squareness

Cutting Speed Vc (m/min.)	150
Feed Rate fz (mm/tooth)	0.1
Axial DOC ap (mm)	5
Radial DOC ae (mm)	0.1

BIG KAISER	10 µm
Other manufacturer	40 µm

Wiper cutting edge

Cutting Speed Vc (m/min.)	250
Feed Rate fz (mm/tooth)	0.2
Axial DOC ap (mm)	0.1
Radial DOC ae (mm)	50

BIG KAISER	Ra=0.51 µm
Other manufacturer	Ra=1.56 µm

Accessories & Spare Parts

<p>Face Mill Arbors Type FMH BBT</p> <p>► 96</p>	<p>Face Mill Arbors Type FMH BDV</p> <p>► 146</p>	<p>Face Mill Arbors Type FMH HSK-A</p> <p>► 194</p>	<p>Indexable Inserts for Fullcut Mill FCM</p> <p>► 528</p>	<p>Wrench</p> <p>► 540</p>	<p>Insert Clamping Screw Set</p> <p>► 540</p>
--	---	---	--	----------------------------	---

Fullcut Mill FCM

Indexable Inserts



Marking Description

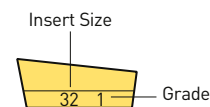

- 1: ACZ310
- 2: DS20
- P2: ACP200
- 3F: ACM300F
- P3: ACP300

Model	Cutter Dia. ØD	ap	Nose R	P		M	K	N
				ACP200	ACP300	ACM300F	ACZ310	DS20
ARG160902	12 - 17	9	0.2	-	978.812	807.728	800.488	978.801
ARG160904			0.4	978.827	966.245	807.729	966.248	966.249
ARG200902	20, 21	9	0.2	-	978.813	807.730	800.046	978.807
ARG200904			0.4	978.804	966.250	807.731	966.253	966.254
ARG250902	25, 26	9	0.2	-	978.814	807.732	800.047	978.803
ARG250904			0.4	800.048	966.255	807.733	966.258	966.259
ARG321102	32, 33	11	0.2	-	978.828	807.735	800.049	966.270
ARG321104			0.4	800.051	966.260	807.736	966.263	966.264
ARG401102	40, 50	11	0.2	-	800.052	807.737	800.053	978.821
ARG401104			0.4	978.809	966.265	807.738	966.268	966.269
ARG631104	63	11	0.4	-	978.829	807.739	-	978.830
ARG631108			0.8	978.810	966.280	807.740	966.283	966.284
ARG801104	80, 100	11	0.4	-	978.831	807.741	-	978.832
ARG801108			0.8	978.811	966.285	807.742	966.288	966.289

1. ACP300 is first recommendation for steel and ACM300S is first recommendation for stainless steel.
2. Inserts are available in a packet of 10pcs.

Caution

- It is important to use the correct insert for the diameter of Fullcut Mill. Failure to use the correct insert will result in incorrect cutting conditions and poor results.
- Nose radius 0.2 inserts are suitable for light cutting.
- There is no compatibility with those of FCR type.

Insert classifications



ISO	Grade	Material	Coating
P20	ACP200	Prehardened steel	TiAlN / AlCrN
P30	ACP300	General steel	
M30	ACM300F	Stainless steel	TiAlN / TiCN
K10	ACZ310	Cast iron	
N20	DS20	Aluminium	DLC

C.1

Note

It is recommended to regularly replace clamping screws and wrench to ensure the correct clamping force is maintained.

Accessories & Spare Parts

<p>Wrench</p>  <p>► 540</p>	<p>Insert Clamping Screw Set</p>  <p>► 540</p>
--	---

Fullcut Mill FCM

Recommended Cutting Condition

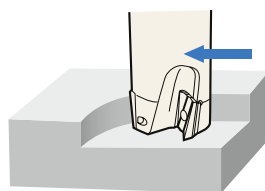

Shoulder milling and slot milling

Finish-light cutting

Cutter Dia.	Work Material	Carbon Steel Alloy Steel	Unalloyed Steel	Prehardened Steel < HRC40	Stainless Steel	Cast Iron	Aluminium
	Insert Grade	ACP300		ACP200	ACM300F	ACZ310	DS20
	Cutting Fluid	Dry					Dry/Wet
Ø12 - Ø14	Speed (m/min)	150 - 250	180 - 250	80 - 140	140 - 180	100 - 200	200 - 750
	Feed (mm/tooth)	0.1 - 0.2	0.1 - 0.2	0.08 - 0.12	0.12 - 0.18	0.1 - 0.2	0.1 - 0.3
Ø16 - Ø21	Speed (m/min)	150 - 250	180 - 250	80 - 140	140 - 180	100 - 200	200 - 1000
	Feed (mm/tooth)	0.1 - 0.2	0.1 - 0.2	0.08 - 0.12	0.12 - 0.18	0.1 - 0.2	0.1 - 0.3
Ø25 - Ø33	Speed (m/min)	180 - 280	200 - 280	80 - 140	140 - 200	100 - 200	200 - 1500
	Feed (mm/tooth)	0.1 - 0.24	0.1 - 0.22	0.08 - 0.14	0.12 - 0.2	0.1 - 0.2	0.1 - 0.35
Ø40 - Ø50	Speed (m/min)	180 - 280	200 - 280	80 - 140	140 - 200	80 - 200	200 - 1500
	Feed (mm/tooth)	0.1 - 0.24	0.1 - 0.22	0.08 - 0.14	0.12 - 0.2	0.1 - 0.2	0.1 - 0.35
Ø63 - Ø100	Speed (m/min)	100 - 220	150 - 240	80 - 120	120 - 180	100 - 200	200 - 1500
	Feed (mm/tooth)	0.1 - 0.24	0.1 - 0.22	0.08 - 0.14	0.12 - 0.2	0.1 - 0.25	0.1 - 0.35

Caution

Fullcut Mill, FCM type, cannot be used for feeding in Z-axis such as ramping, plunging and boring.

Medium-heavy cutting

Cutter Dia.	Work Material	Carbon Steel Alloy Steel	Unalloyed Steel	Stainless Steel	Cast Iron	Aluminium
	Insert Grade	ACP300		ACM300F	ACZ310	DS20
	Cutting Fluid	Dry				
Ø12 - Ø14	Speed (m/min)	100 - 200	150 - 200	120 - 180	100 - 180	200 - 750
	Feed (mm/tooth)	0.08 - 0.14	0.1 - 0.15	0.12 - 0.15	0.08 - 0.18	0.1 - 0.2
Ø16 - Ø21	Speed (m/min)	100 - 200	150 - 200	120 - 180	100 - 180	200 - 1000
	Feed (mm/tooth)	0.08 - 0.14	0.1 - 0.15	0.12 - 0.15	0.08 - 0.18	0.1 - 0.2
Ø25 - Ø50	Speed (m/min)	100 - 200	160 - 220	120 - 180	100 - 200	200 - 1500
	Feed (mm/tooth)	0.1 - 0.16	0.1 - 0.15	0.12 - 0.15	0.08 - 0.2	0.1 - 0.3
Ø63 - Ø100	Speed (m/min)	100 - 200	150 - 200	120 - 180	100 - 180	200 - 750
	Feed (mm/tooth)	0.08 - 0.18	0.1 - 0.16	0.12 - 0.15	0.1 - 0.2	0.1 - 0.3

Caution

- Nose radius 0.2 inserts are suitable for light cutting.
- Care should be taken in the selection of both axial & radial depth of cut as well as the feed rate.
- This table is a general guideline for cutting data. Please adjust according to machine and workpiece conditions, as well as width of cutting.
- Dry cutting (including air blow) is recommended when cutting of steel, except for finishing.
- Dry cutting is recommended for stainless steel. However use soluble oil in a case where severe built-up edge occurs.

Fullcut Mill FCM

Application Examples

Slot milling



Fullcut Mill	BBT40-FCM32113-85
Insert	ARG321104 (ACP300)
Work Material	C50 (S50C)
Cutting Speed Vc (m/min.)	150
Feed Rate fz (mm/tooth)	0.12
Axial DOC ap (mm)	9



Only Fullcut Mill was capable of achieving this data in a No.40 spindle taper machine.

Shoulder milling



Fullcut Mill	BBT40-FCM32113-85
Insert	ARG321104 (ACP300)
Work Material	C50 (S50C)
Cutting Speed Vc (m/min.)	200
Feed Rate fz (mm/tooth)	0.15
Axial DOC ap (mm)	11
Radial DOC ae (mm)	5

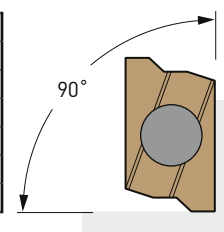

Excellent perpendicularity is achieved.

Face milling



Fullcut Mill	BBT40-FCM50115-70
Insert	ARG401104 (ACP300)
Work Material	C50 (S50C)
Cutting Speed Vc (m/min.)	200
Feed Rate fz (mm/tooth)	0.15
Axial DOC ap (mm)	1
Radial DOC ae (mm)	30

	Surface Roughness Rz
BIG KAISER	2.53
Manufacturer A	3.75
Manufacturer B	4.32

Finishing surface roughness was Rz = 2.53 at Vc = 200 m/min, fz = 0.15 mm/tooth cutting data.

Material of low machinability

C.1



Fullcut Mill	ST25-FCM25093-120
Holder	BBT50-MEGA25D-105
Insert	ARG250904 (ACM300F)
Work Material	SUS304 Stainless steel
Cutting Speed Vc (m/min.)	150
Feed Rate fz (mm/tooth)	0.2
Axial DOC ap (mm)	9
Radial DOC ae (mm)	3



High efficiency and stable milling (Vf = 1140 mm/min.) is achieved.

Fullcut Mill FCR - For Standard Type with BBT

Designed for multi-functional cutting.

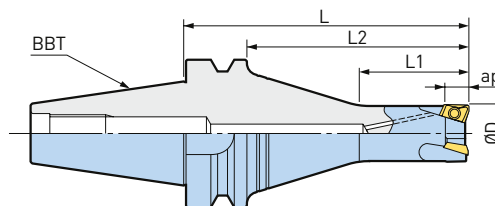
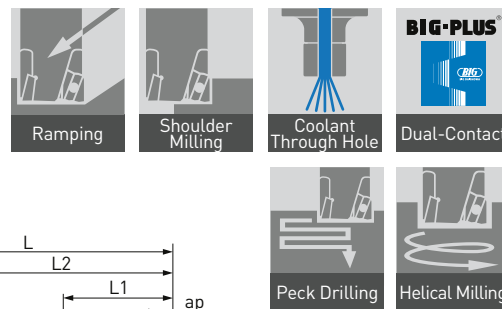





Model	Order No.	ØD	L	L1	L2	ap	Number of Inserts	Insert size
BBT30-FCR16082-65	966.683	16	65	28	43	8	2	BRG16
BBT30-FCR20083-65	966.685	20	65	28	43	8	3	BRG20
BBT30-FCR25083-65	966.687	25	65	33	43	8	3	BRG25
BBT30-FCR25083-105	100654.001.0	25	105	35	83	8	3	BRG25
BBT30-FCR32103-65	966.689	32	65	40	43	10	3	BRG32
BBT30-FCR32103-105	100654.002.0	32	105	45	83	10	3	BRG32
BBT40-FCR16082-85	966.616	16	85	25	58	8	2	BRG16
BBT40-FCR16082-120	966.617	16	120	30	93	8	2	BRG16
BBT40-FCR16082-135	966.618	16	135	25	108	8	2	BRG16
BBT40-FCR20083-85	966.619	20	85	35	58	8	3	BRG20
BBT40-FCR20083-120	966.620	20	120	30	93	8	3	BRG20
BBT40-FCR20083-135	966.621	20	135	30	108	8	3	BRG20
BBT40-FCR25083-85	966.622	25	85	40	58	8	3	BRG25
BBT40-FCR25083-120	966.623	25	120	45	93	8	3	BRG25
BBT40-FCR25083-135	966.624	25	135	35	108	8	3	BRG25
BBT40-FCR32103-85	966.625	32	85	45	58	10	3	BRG32
BBT40-FCR32103-120	966.626	32	120	50	93	10	3	BRG32
BBT40-FCR32103-135	966.627	32	135	40	108	10	3	BRG32

1. BIG-PLUS® tools can be used in machining centers with non BIG-PLUS® spindles.
2. Wrench is included.
3. Inserts are to be ordered separately.

C.1

Accessories & Spare Parts

<p>Indexable Inserts for Fullcut Mill FCR</p>  <p>► 537</p>	<p>Adapter for BBT50 taper shank</p>  <p>► 519</p>	<p>Wrench</p>  <p>► 540</p>	<p>Insert Clamping Screw Set</p>  <p>► 540</p>
--	---	--	---

Fullcut Mill FCR - For Long Nose Type with BBT

Unique inserts designed for ramping make multi-functional cutting possible.

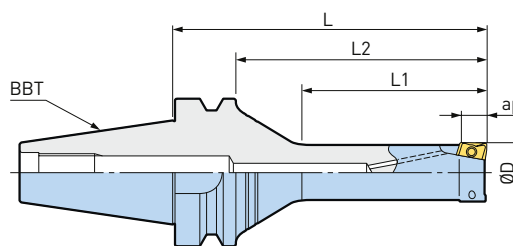
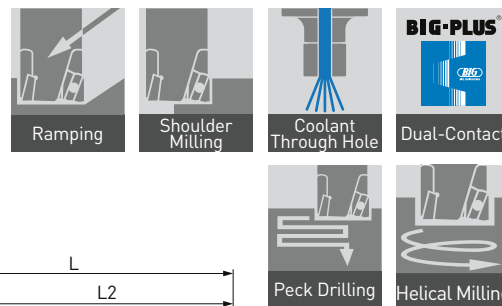





Model	Order No.	ØD	L	L1	L2	ap	Number of Inserts	Insert size
BBT30-FCR16082L-85	966.684	16	85	45	63	8	2	BRG16
BBT30-FCR20082L-85	966.686	20	85	50	63	8	2	BRG20
BBT30-FCR25082L-85	966.688	25	85	50	63	8	2	BRG25
BBT30-FCR32102L-85	966.690	32	85	60	63	10	2	BRG32
BBT40-FCR16082L-105	966.691	16	105	45	78	8	2	BRG16
BBT40-FCR16082L-120	966.692	16	120	45	93	8	2	BRG16
BBT40-FCR20082L-120	966.693	20	120	60	93	8	2	BRG20
BBT40-FCR20082L-135	966.694	20	135	60	108	8	2	BRG20
BBT40-FCR25082L-135	966.695	25	135	75	108	8	2	BRG25
BBT40-FCR25082L-150	966.696	25	150	75	123	8	2	BRG25
BBT40-FCR32102L-135	966.697	32	135	80	108	10	2	BRG32
BBT40-FCR32102L-150	966.698	32	150	90	123	10	2	BRG32

1. BIG-PLUS® tools can be used in machining centers with non BIG-PLUS® spindles.
2. Wrench is included.
3. Inserts are to be ordered separately.

C.1

Accessories & Spare Parts

<p>Indexable Inserts for Fullcut Mill FCR</p>  <p>► 537</p>	<p>Adapter for BBT50 taper shank</p>  <p>► 519</p>	<p>Wrench</p>  <p>► 540</p>	<p>Insert Clamping Screw Set</p>  <p>► 540</p>
--	---	--	---

Fullcut Mill FCR - For Standard Type with BDV



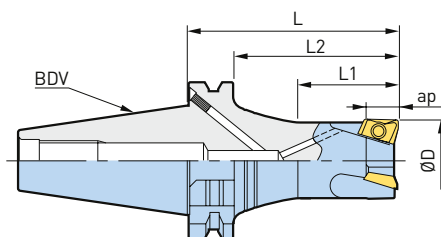
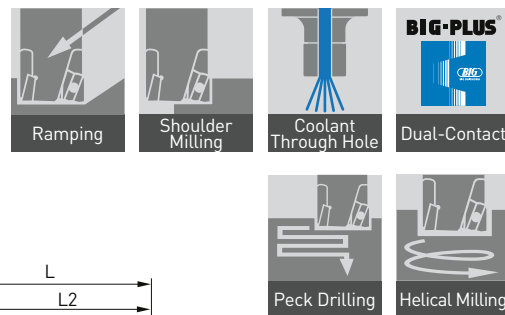

Unique inserts designed for ramping make multi-functional cutting possible.



Model	Order No.	ØD	L	L1	L2	ap	Number of Inserts	Insert size
BDV40-FCR16082-85	966.601	16	85	25	65	8	2	BRG16
BDV40-FCR16082-120	966.602	16	120	30	100	8	2	BRG16
BDV40-FCR16082-135	966.603	16	135	25	115	8	2	BRG16
BDV40-FCR20083-85	966.604	20	85	35	65	8	3	BRG20
BDV40-FCR20083-120	966.605	20	120	30	100	8	3	BRG20
BDV40-FCR20083-135	966.606	20	135	30	115	8	3	BRG20
BDV40-FCR25083-85	966.607	25	85	40	65	8	3	BRG25
BDV40-FCR25083-120	966.608	25	120	45	100	8	3	BRG25
BDV40-FCR25083-135	966.609	25	135	35	115	8	3	BRG25
BDV40-FCR32103-85	966.610	32	85	45	65	10	3	BRG32
BDV40-FCR32103-120	966.611	32	120	50	100	10	3	BRG32
BDV40-FCR32103-135	966.612	32	135	40	115	10	3	BRG32

1. BIG-PLUS® tools can be used in machining centers with non BIG-PLUS® spindles.
2. Wrench is included.
3. Inserts are to be ordered separately.

Accessories & Spare Parts

<p>Indexable Inserts for Fullcut Mill FCR</p>  <p>► 537</p>	<p>Adapter for BDV50 taper shank</p>  <p>► 520</p>	<p>Wrench</p>  <p>► 540</p>	<p>Insert Clamping Screw Set</p>  <p>► 540</p>
--	---	--	---

Fullcut Mill FCR - For Standard Type with HSK-A

Unique inserts designed for ramping make multi-functional cutting possible.

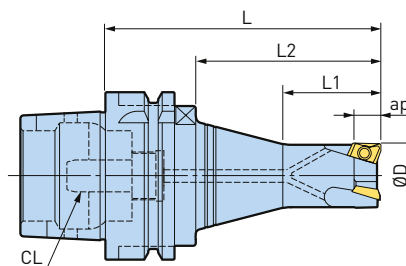
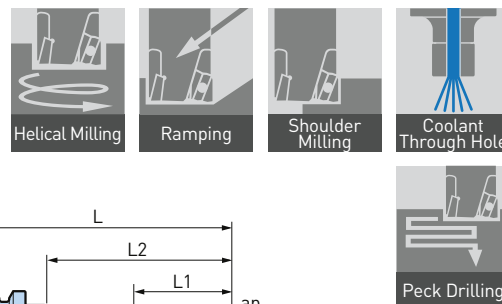





Model	Order No.	ØD	L	L1	L2	ap	Number of Inserts	Insert size
HSK-A50-FCR16082-75	966.671	16	75	27	41	8	2	BRG16
HSK-A50-FCR20083-75	966.672	20	75	28	41	8	3	BRG20
HSK-A50-FCR25083-75	966.673	25	75	33	41	8	3	BRG25
HSK-A50-FCR32103-75	966.674	32	75	39	41	10	3	BRG32
HSK-A63-FCR16082-85	966.631	16	85	25	51	8	2	BRG16
HSK-A63-FCR16082-120	966.632	16	120	30	86	8	2	BRG16
HSK-A63-FCR16082-135	966.633	16	135	25	101	8	2	BRG16
HSK-A63-FCR20083-85	966.634	20	85	32	51	8	3	BRG20
HSK-A63-FCR20083-120	966.635	20	120	30	86	8	3	BRG20
HSK-A63-FCR20083-135	966.636	20	135	30	101	8	3	BRG20
HSK-A63-FCR25083-85	966.637	25	85	35	51	8	3	BRG25
HSK-A63-FCR25083-120	966.638	25	120	45	86	8	3	BRG25
HSK-A63-FCR25083-135	966.639	25	135	35	101	8	3	BRG25
HSK-A63-FCR32103-85	966.640	32	85	40	51	10	3	BRG32
HSK-A63-FCR32103-120	966.641	32	120	50	86	10	3	BRG32
HSK-A63-FCR32103-135	966.642	32	135	40	101	10	3	BRG32

1. Wrench is included.
2. Coolant pipe (CL) and inserts are to be ordered separately.

C.1

Accessories & Spare Parts

<p>Indexable Inserts for Fullcut Mill FCR</p>  <p>► 537</p>	<p>Coolant Pipes</p>  <p>► 228</p>	<p>Wrench</p>  <p>► 540</p>	<p>Insert Clamping Screw Set</p>  <p>► 540</p>
--	---	--	---

Fullcut Mill FCR - For Long Nose Type with HSK-A

Unique inserts designed for ramping make multi-functional cutting possible.

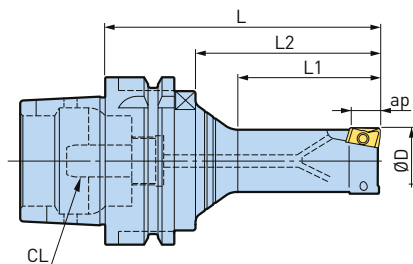
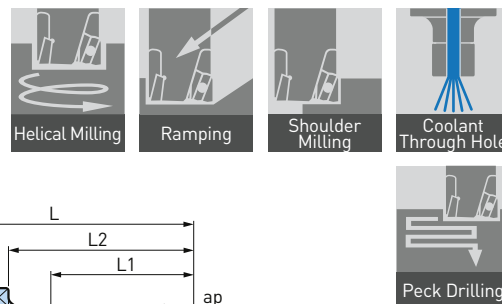





Model	Order No.	ØD	L	L1	L2	ap	Number of Inserts	Insert size
HSK-A63-FCR16082L-85	966.675	16	85	40	51	8	2	BRG16
HSK-A63-FCR16082L-120	966.676	16	120	45	86	8	2	BRG16
HSK-A63-FCR20082L-105	966.677	20	105	50	71	8	2	BRG20
HSK-A63-FCR20082L-120	966.678	20	120	60	86	8	2	BRG20
HSK-A63-FCR25082L-105	966.679	25	105	55	71	8	2	BRG25
HSK-A63-FCR25082L-120	966.680	25	120	65	86	8	2	BRG25
HSK-A63-FCR32102L-120	966.681	32	120	70	86	10	2	BRG32
HSK-A63-FCR32102L-135	966.682	32	135	80	101	10	2	BRG32

1. Wrench is included.
2. Coolant pipe (CL) and inserts are to be ordered separately.

C.1

Accessories & Spare Parts

<p>Indexable Inserts for Fullcut Mill FCR</p>  <p>► 537</p>	<p>Coolant Pipes</p>  <p>► 228</p>	<p>Wrench</p>  <p>► 540</p>	<p>Insert Clamping Screw Set</p>  <p>► 540</p>
--	---	--	---

Fullcut Mill FCR - For Oversize Type

Unique inserts designed for ramping make multi-functional cutting possible.

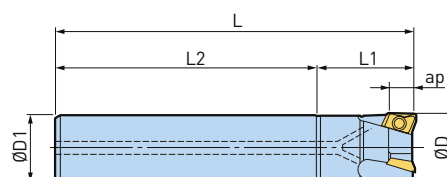
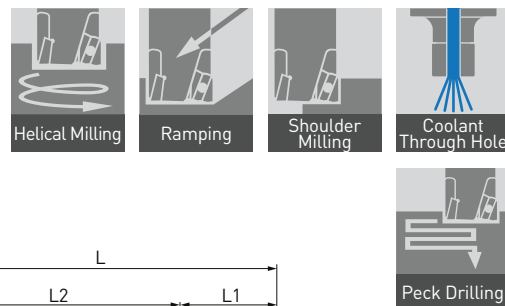



Model	Order No.	ØD	ØD1	L	L1	L2	ap	Number of Inserts	Insert size
ST15-FCR16082-120	805.849	16	15	120	25	95	8	2	BRG16
ST16-FCR17082-120	802.191	17	16	120	25	95	8	2	BRG16
ST19-FCR20082-165	805.850	20	19	165	30	135	8	2	BRG20
ST19-FCR20083-135	805.851	20	19	135	30	105	8	3	BRG20
ST20-FCR21082-165	802.192	21	20	165	30	135	8	2	BRG20
ST20-FCR21083-135	802.193	21	20	135	30	105	8	3	BRG20
ST24-FCR25082-180	805.852	25	24	180	35	145	8	2	BRG25
ST24-FCR25083-150	805.853	25	24	150	35	115	8	3	BRG25
ST25-FCR26082-165	802.220	26	25	165	38	127	8	2	BRG25
ST25-FCR26083-150	802.221	26	25	150	38	112	8	3	BRG25
ST28-FCR32102-180	805.854	32	28	180	48	132	10	2	BRG32
ST28-FCR32103-180	805.855	32	28	180	48	132	10	3	BRG32
ST32-FCR33102-180	802.225	33	32	180	48	132	10	2	BRG32
ST32-FCR33103-180	802.226	33	32	180	48	132	10	3	BRG32

1. Wrench is included.
2. Inserts are to be ordered separately.
3. Lower cutting parameters appropriately for applications with either long projection or 3-flutes models.
4. For medium-heavy or heavy slot milling or ramping with projection longer than 2.5 times of diameter, 2-flutes models are recommended.

C.1

Accessories & Spare Parts

<p>Indexable Inserts for Fullcut Mill FCR</p>  <p>► 537</p>	<p>Wrench</p>  <p>► 540</p>	<p>Insert Clamping Screw Set</p>  <p>► 540</p>
--	--	---

Fullcut Mill FCR

Indexable Inserts



Model	Cutter Dia. ØD	ap	Nose R	P	M	K	N
				ACP300	ACM300F	ACZ310	DS20
BRG160808	16, 17	8	0.8	807.131	807.135	966.652	966.653
BRG200808	20, 21	8	0.8	807.132	807.136	800.587	966.658
BRG250808	25, 26	8	0.8	807.133	807.137	966.662	966.663
BRG321008	32, 33	10	0.8	807.134	807.138	966.667	966.668
BRG321032		10	3.2	-	-	-	966.669

1. Inserts are available in packets of 10 pcs.

Caution

- It is important to use the correct insert for the diameter of Fullcut Mill. Failure to use the correct insert will result in incorrect cutting conditions and poor results.
- There is no compatibility with those of FCM type.

Insert classifications

ISO	Grade	Material	Coating
P30	ACP300	General steel	TiAlN / TiCN
M30	ACM300F	Stainless steel	
K10	ACZ310	Cast iron	
N20	DS20	Aluminium	DLC

Marking Description



Accessories & Spare Parts

<p>Wrench</p> <p>► 540</p>	<p>Insert Clamping Screw Set</p> <p>► 540</p>
----------------------------	---

Fullcut Mill FCR

Recommended Cutting Condition

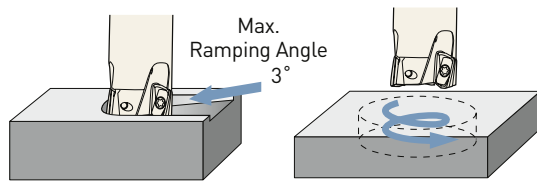

Cutter Dia.	Flat Bottom		Through Hole
	Max. Hole Dia.	Min. Hole Dia.	Min. Hole Dia.
Ø16	Ø30	Ø27	Ø22
Ø20	Ø38	Ø36	Ø29
Ø25	Ø48	Ø45	Ø39
Ø32	Ø62	Ø59	Ø48

Ramping and helical interpolation

Cutter Dia.	Work Material	Carbon Steel Alloy Steel	Unalloyed Steel	Prehardened Steel < HRC40	Stainless Steel	Die Steel	Cast Iron	Aluminium
	Insert Grade	ACP300		ACM300F			ACZ310	DS20
	Cutting Fluid	Dry		Dry	Dry	Dry		Dry/Wet
Ø16, Ø17	Speed (m/min)	100 - 200	150 - 220	60 - 80	100 - 150	60 - 80	100 - 180	200 - 1000
	Feed (mm/tooth)	0.06 - 0.12	0.06 - 0.12	0.05 - 0.08	0.08 - 0.16	0.06 - 0.1	0.08 - 0.18	0.06 - 0.24
Ø20, Ø25, Ø26	Speed (m/min)	100 - 200	150 - 200	60 - 100	120 - 150	60 - 100	100 - 180	200 - 1000
	Feed (mm/tooth)	0.08 - 0.2	0.08 - 0.2	0.05 - 0.1	0.12 - 0.2	0.06 - 0.1	0.02 - 0.18	0.1 - 0.35
Ø32, Ø33	Speed (m/min)	100 - 200	150 - 200	60 - 100	120 - 150	60 - 120	100 - 180	200 - 1000
	Feed (mm/tooth)	0.08 - 0.2	0.08 - 0.2	0.05 - 0.1	0.12 - 0.2	0.08 - 0.12	0.06 - 0.2	0.1 - 0.35

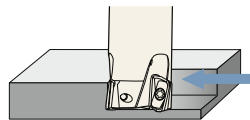

Shoulder milling and slot milling

Cutter Dia.	Work Material	Carbon Steel Alloy Steel	Unalloyed Steel	Prehardened Steel < HRC40	Stainless Steel	Die Steel	Cast Iron	Aluminium
	Insert Grade	ACP300		ACM300F			ACZ310	DS20
	Cutting Fluid	Dry		Dry	Dry	Dry		Dry/Wet
Ø16, Ø20, Ø21	Speed (m/min)	100 - 200	100 - 200	60 - 80	120 - 180	80 - 120	100 - 180	200 - 1000
	Feed (mm/tooth)	0.08 - 0.18	0.08 - 0.18	0.05 - 0.1	0.12 - 0.18	0.08 - 0.12	0.08 - 0.18	0.1 - 0.3
Ø25, Ø32, Ø33	Speed (m/min)	100 - 200	100 - 200	60 - 100	120 - 180	80 - 120	100 - 180	200 - 1500
	Feed (mm/tooth)	0.08 - 0.2	0.08 - 0.2	0.05 - 0.1	0.12 - 0.2	0.08 - 0.12	0.08 - 0.2	0.1 - 0.35

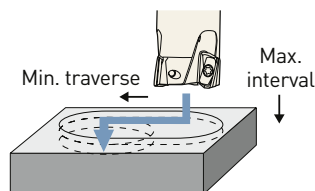

Cutter Dia.	Max. Interval	Min. Traverse
Ø16	0.5	14
Ø20	1	18
Ø25	1	23
Ø32	2	30

Plunge milling

Cutter Dia.	Work Material	Carbon Steel Alloy Steel	Unalloyed Steel	Prehardened Steel < HRC40	Stainless Steel	Die Steel	Cast Iron	Aluminium
	Insert Grade	ACP300		ACM300F			ACZ310	DS20
	Cutting Fluid	Dry		Dry	Dry	Dry		Dry/Wet
Ø16, Ø17	Speed (m/min)	80 - 120	80 - 120	60	80 - 120	60 - 80	80 - 160	200 - 350
	Feed (mm/tooth)	0.06 - 0.1	0.06 - 0.1	0.04 - 0.06	0.05 - 0.08	0.05 - 0.08	0.06 - 0.1	0.06 - 0.1
Ø20, Ø25, Ø26	Speed (m/min)	100 - 160	100 - 160	60 - 100	100 - 160	60 - 100	80 - 180	200 - 500
	Feed (mm/tooth)	0.1 - 0.25	0.1 - 0.25	0.1 - 0.25	0.12 - 0.25	0.1 - 0.2	0.08 - 0.3	0.1 - 0.3
Ø32, Ø33	Speed (m/min)	100 - 160	100 - 160	60 - 100	100 - 160	60 - 100	80 - 180	200 - 600
	Feed (mm/tooth)	0.1 - 0.3	0.1 - 0.3	0.1 - 0.3	0.12 - 0.3	0.1 - 0.2	0.08 - 0.4	0.1 - 0.3

Caution

- The table is just a reference to determine cutting conditions. It should be adjusted according to a condition of a machine tool or workpiece.
- Since chips may scatter, utilize safety enclosures.

C.1

Fullcut Mill FCR

Application Examples

Bore

Dia. 38 with Helical milling



Fullcut Mill	BBT40-FCR20083-120
Insert	BRG200808 (ACP300)
Work Material	C50 (S50C) / Air blow
Cutting Speed Vc (m/min.)	150
Feed Rate Vf (mm/min.)	1100
Axial DOC ap (mm)	2 mm x 3 times
Hole dia.	Ø 38

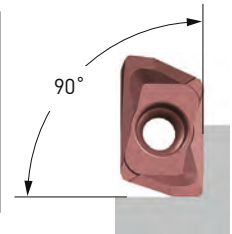

For carbon steel of C50, very smooth cutting with feed rate of Vf=1100 mm/min and excellent squareness are achieved.

Honeycombed

Pocket with Ramping



Fullcut Mill	BBT40-FCR20083-85
Insert	BRG200808 (DS20)
Work Material	A2017 Duralumin / Air blow
Cutting Speed Vc (m/min.)	750
Feed Rate Vf (mm/min.)	4300
Axial DOC ap (mm)	6 mm x 3 times
Radial DOC ae (mm)	max. 20

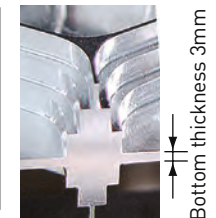

For less rigid workpiece with 3 mm thickness clamped by a vise, feed rate of Vf=4300 mm/min on both sides of the workpiece is achieved.

Helical milling

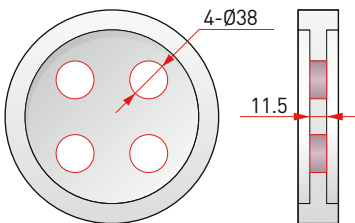

Fullcut Mill	BBT40-FCR20083-120
Insert	BRG200808 (ACP300)
Work Material	15CrMo5 (SCM415)
Cutting Speed Vc (m/min.)	150
Feed Rate Vf (mm/min.)	480
Axial DOC ap (mm)	4 mm x 3 times
Hole dia.	Ø 38

Compared to another manufacturer

Axial DOC **1.3 times**
Insert life **2 times**

Stable helical milling with 4 mm axial DOC on less rigid workpiece.

Ramping

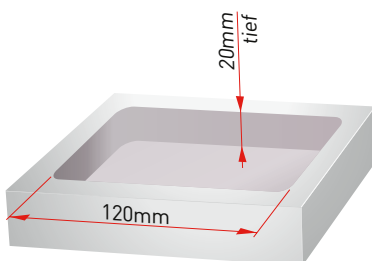

Fullcut Mill	BBT50-BBT40-50 BBT40-FCR16082-120
Insert	BRG160808 (ACP300)
Work Material	C50 (S50C)
Cutting Speed Vc (m/min.)	120
Feed Rate Vf (mm/min.)	480
Axial DOC ap (mm)	4 mm x 5 times

Compared to another manufacturer

No chatter even at higher resistance corner.

Smooth chip evacuation eliminates re-cutting of the swarf and edge chipping of the inserts.

Example of use of BBT50-BBT40 adapter. An improved result is obtained compared to the product from another manufacturer.

Spare Parts for Fullcut Mill, FCM and FCR

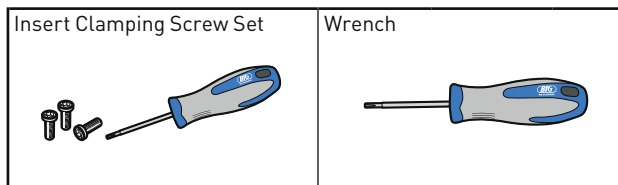

FCM		FCR		Model	Order No.	Model	Order No.	Torx Size
Cutter Dia. Ø	Insert	Cutter Dia. Ø	Insert					
12	ARG1609	-	-	S2505DS	966.271	DA-T8	966.274	T-8
14, 16, 17		16, 17	BRG1608					
20, 21	ARG2009	20, 21	BRG2008	S2506DS	966.272	DA-T8	966.274	T-8
25, 26	ARG2509	25, 26	BRG2508					
32, 33	ARG3211	32, 33	BRG3210	S3508DS	966.273	DA-T15	966.275	T-15
40, 50	ARG4011							
63	ARG6311							
80, 100	ARG8011							



1. Insert clamping set contains 10 pcs screw and 1 pcs wrench.

Torque Wrench for Fullcut Mill

Torque wrench with fix Nm more precision. Ergonomic multi-component handle, particularly light and compact.

Torque Wrench Set		Torque Wrench Body		Torque Wrench Bit	
					
Torx Size	Fixed Torque	Order No.	Order No.	Order No.	
T8	0.8 Nm	694.183	694.162	694.169	
T15	3.0 Nm	694.186	694.165	694.172	

1. Torque wrench set contains 1 pcs wrench body and 1 pcs wrench bit.

Surface Mill

For superior surface finishing.

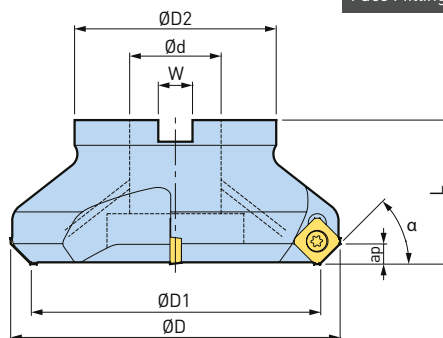

Model	Order No.	ØD	ØD1	ØD2	Ød	L	W	ap	α	Number of Inserts
FM27-SFM804-40	805.890	91.6	80	60	27	40	12.4	5	45°	4

1. Wrench and screws are included.
2. Inserts are to be ordered separately.
3. MBA - M12H is required to be mounted on FMH27.

Indexable Inserts

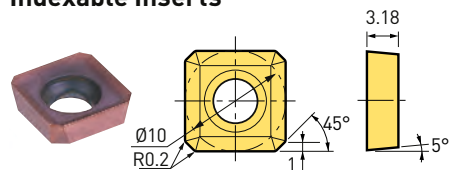

Model	Order No.	Coating
CM10C1 ACP200	966.445	Multi-layer TiAlN & AlCrN for general steel
CM10C1 DS20	966.446	DLC coating for aluminum & non-ferrous
CM10C1 ACM250F	807.188	Ultra-multilayered thin film structure made of AlTiN and TiAlCrN
CM10C1 NF15KA	807.684	Non-coating

Recommended Cutting Condition

Work Material	Insert Grade	Cutting Speed Vc (m/min)	Feed Rate fz (mm/t)	Axial DOC ap max (mm)
General Steel	ACP200	150-200-250	0.10-0.20-0.30	3
Prehardened Steel		180-240-300	0.10-0.25-0.40	4
Stainless Steel	ACM250F	160-205-250	0.15-0.23-0.30	3
Cast Iron	NF15KA	100-175-250	0.15-0.23-0.30	4
Aluminium, Non-ferrous	DS20	500-750-1000	0.15-0.23-0.30	5

Insert Clamp Screw Set

Insert clamping screw set (10) screws & (1) wrench		Driver-Type Wrench	
Model	Order No.	Model	Order No.
S4S-T15DS	805.897	DA-T15	966.275

C.1

Accessories & Spare Parts

Face Mill Arbors Type FMH BBT ▶ 96	Face Mill Arbors Type FMH BDV ▶ 146	Face Mill Arbors Type FMH HSK-A ▶ 194	Indexable Inserts for Surface Mill ▶ 541	Insert Clamping Screw Set ▶ 541
---	--	--	---	--

Speed Finisher

Amazing improvement of surface finish at high speed cutting.

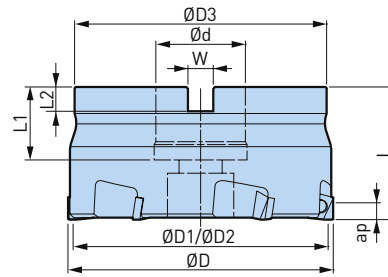
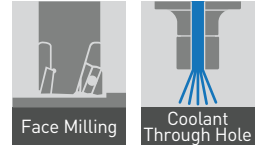

Model	Order No.	$\varnothing d$	$\varnothing D$	$\varnothing D1$	$\varnothing D2$	$\varnothing D3$	L	L1	L2	W	Number of Inserts	max. min-1
FM22-PLS505-35	978.276	22	50	46.9	44.9	47	35	19	6	10.4	5	20000
FM22-PLS636-35	978.313	27	63	59.9	57.9	60	35	19	6	10.4	6	20000
FM27-PLS806-40	978.277	27	80	76.9	74.9	76	40	22	7	12.4	6	16000
FM27-PLS1006-35 *	805.847	27	100	69.9	94.9	60	35	24	7	12.4	6	12800
FM27-PLS1256-35 *	805.848	27	125	121.9	119.9	60	35	24	7	12.4	6	10200
FM32-PLS1006-42	801.684	32	100	96.9	94.9	96	42	24	8	14.4	6	12800
FM40-PLS1258-50	805.284	40	125	121.9	119.9	100	50	28	9	16.4	8	10200
FM40-PLS16010-50	805.283	40	160	156.9	154.9	100	50	28	9	16.4	10	8000

- *Light weight design exclusive for BT30.
- Wrench and screws are included.
- Inserts are to be ordered separately.
- When using at 12 000 min- or higher speed, contact agent for balancing of the cutter and arbor assembly.
- Effective cutting edge length ap varies depending on insert models. $\varnothing D1/\varnothing D2$
- Adjusting amount of cutting edge is 0.1 mm. Note this when using reground insert.

Indexable Inserts for Speed Finisher

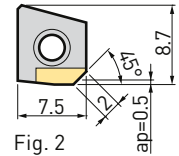
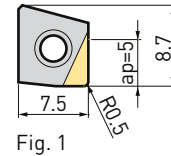

Model	Order No.	Fig.	Workpiece	Insert Grade	ap
PL0705(DA2200)	978.278	1	Aluminium & nonferrous	PCD	5
PL0705(CBN)	978.820	2	Cast iron	CBN	0.5

Insert Grade

DA2200	CBN
High density sintered material made of ultra-micro diamond particles. Superior hardness comparable to carbide alloy and wear resistance.	Newly designed CBN sintered body with high content rate of CBN improves toughness and thermal conductivity.

Recommended Cutting Condition



Workpiece Material	Insert Material	Cutting Speed (m/min)	Feed Rate (mm/tooth)	Coolant
Aluminium Alloy	DA2200	2 000 - 4 000	0.05 - 0.2	Wet
		400 - 800		
Copper Alloy	DA2200	500 - 2 500	0.05 - 0.2	Wet
Gray Cast Iron	CBN	800 - 2 000	0.1 - 0.3	Dry

The table is a reference to determine cutting conditions. It should be adjusted according to cutting width, conditions of the machine tool and workpiece.

Accessories & Spare Parts

Face Mill Arbors Type FMH BBT	Face Mill Arbors Type FMH BDV	Face Mill Arbors Type FMH HSK-A	Spare Parts - For Speed Finisher	Wrench	Insert Clamping Screw Set
					
▶ 96	▶ 146	▶ 194	▶ 543	▶ 543	▶ 543

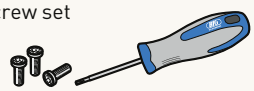
Accessories for Speed Finisher

Spare Parts					
Lifting screw set (1) lifting screw & (1) lifting nut		Insert clamping screw set (10) screws & (1) wrench		Wrench	
Model	Order No.	Model	Order No.	Model	Order No.
LSN35	804.796	S2506DS	966.272	DA-T8	966.274

Insert clamping screws and wrenches are consumables. Regular replacement and storage are recommended.

Presetter for Speed Finisher

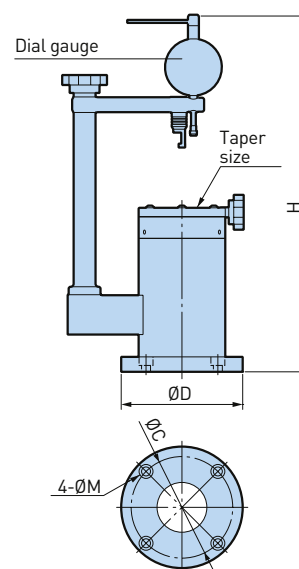

Model	Order No.	ØD	ØC	ØM	H
PLP-BBT30	804.644	122	102	9 (M8)	417
PLP-BBT40	804.645	122	102	9 (M8)	417
PLP-BBT50	804.646	172	149	11 (M10)	502
PLP-HSK63	978.275	122	102	9 (M8)	417

1. Dial gauge and indicator stabilizer (2 pcs. AAA batteries included) are standard accessories.
2. Min. reading of the accessory dial gauge is 0.001mm.
3. Max. tool length indicated in the table is the dimension from the gauge line of the arbor to the cutting edge.
4. Max. cutter diameter is Ø160mm.

Application Examples

(Cutter diameter: Ø 80)

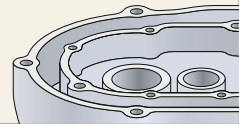
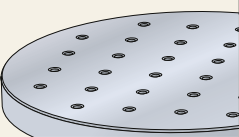
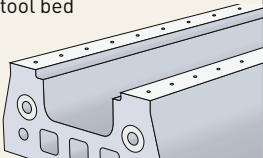
Workpiece	Conditions	Surface Roughness	Height Difference	No. of Workpieces	Result
Crankcase ADC12 	Cutting speed: 4 000 m/min Spindle speed: 15 900 min ⁻¹ Feed rate: 9 550 mm/min Depth of cut: 2.5 mm	Ra = 0.08 µm Rz = 0.55 µm	Within 1 µm	24 000	Rough and finish processes are combined in a single operation.
Parts of semiconductor manufacturing equipment A5052 	Cutting speed: 4 000 m/min Spindle speed: 15 900 min ⁻¹ Feed rate: 9 550 mm/min Depth of cut: 2.0 mm	Ra = 0.07 µm Rz = 0.32 µm	Within 1 µm	320	Mirror finish is achieved.
Machine tool bed FC250 	Cutting speed: 1 500 m/min Spindle speed: 6 000 min ⁻¹ Feed rate: 3 600 mm/min Depth of cut: 0.5 mm	Ra = 0.12 µm Rz = 0.67 µm	Within 2 µm	20	1 to 2 µm flatness is obtained.

C.1

Indexable Insert Drills and Chamfer Mills

Indexable Insert Drills	546
C-Cutter Standard / CKB Type	551
C-Cutter Mini	555
R-Cutter	563
C-Centering Cutter	567
Center Boy	568
C-Cutter Boy	569
BF-Cutter	570
Chamfer Rings for Boring Heads	571
Slot Milling Cutters	572



Indexable Insert Drills, Ø 16 - 30

The BIG KAISER indexable insert drills series 337 are made with straight flutes. This design guarantees good for chip evacuation and high radial and torsional rigidity.

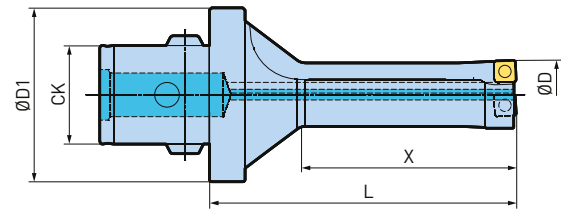





Model	Order No.	CK	ØD	ØD1	L	X	Insert Type
ID16-48CKB6	337.316	CKB6	16	63,5	85	48	WP 337-1
ID16-64CKB6	337.416	CKB6	16	63,5	101	64	WP 337-1
ID17-51CKB6	337.317	CKB6	17	63,5	88	51	WP 337-1
ID17-68CKB6	337.417	CKB6	17	63,5	105	68	WP 337-1
ID18-54CKB6	337.318	CKB6	18	63,5	91	54	WP 337-1
ID18-72CKB6	337.418	CKB6	18	63,5	109	72	WP 337-1
ID19-57CKB6	337.319	CKB6	19	63,5	94	57	WP 337-1
ID19-76CKB6	337.419	CKB6	19	63,5	113	76	WP 337-1
ID20-60CKB6	337.320	CKB6	20	63,5	97	60	WP 337-1
ID20-80CKB6	337.420	CKB6	20	63,5	117	80	WP 337-1
ID21-63CKB6	337.321	CKB6	21	63,5	100	63	WP 337-2
ID21-84CKB6	337.421	CKB6	21	63,5	121	84	WP 337-2
ID22-66CKB6	337.322	CKB6	22	63,5	103	66	WP 337-2
ID22-88CKB6	337.422	CKB6	22	63,5	125	88	WP 337-2
ID23-69CKB6	337.323	CKB6	23	63,5	106	69	WP 337-2
ID23-92CKB6	337.423	CKB6	23	63,5	129	92	WP 337-2
ID24-72CKB6	337.324	CKB6	24	63,5	109	72	WP 337-2
ID24-96CKB6	337.424	CKB6	24	63,5	133	96	WP 337-2
ID25-75CKB6	337.325	CKB6	25	63,5	112	75	WP 337-2
ID25-100CKB6	337.425	CKB6	25	63,5	137	100	WP 337-2
ID26-78CKB6	337.326	CKB6	26	63,5	118	78	WP 337-3
ID26-104CKB6	337.426	CKB6	26	63,5	146	104	WP 337-3
ID27-81CKB6	337.327	CKB6	27	63,5	121	81	WP 337-3
ID27-108CKB6	337.427	CKB6	27	63,5	150	108	WP 337-3
ID28-84CKB6	337.328	CKB6	28	63,5	124	84	WP 337-3
ID28-112CKB6	337.428	CKB6	28	63,5	154	112	WP 337-3
ID29-87CKB6	337.329	CKB6	29	63,5	127	87	WP 337-3
ID29-116CKB6	337.429	CKB6	29	63,5	158	116	WP 337-3
ID30-90CKB6	337.330	CKB6	30	63,5	130	90	WP 337-3
ID30-120CKB6	337.430	CKB6	30	63,5	162	120	WP 337-3

1. Inserts are to be ordered separately.
2. Adjustable drill holder is recommended for clamping.

C.2

Accessories & Spare Parts

<p>Wrench</p>  <p>► 514</p>	<p>Insert Clamping Screw</p>  <p>► 514</p>	<p>Inserts WP 337</p>  <p>► 482</p>	<p>Adjustable Drill Holders for Indexable Drill</p>  <p>► 549</p>
--	---	--	--

Indexable Insert Drills, Ø 19.5 - 74

Indexable insert drills in two lengths(2xD and 3xD) with CKB tool interface.

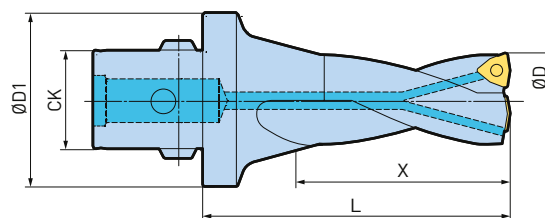
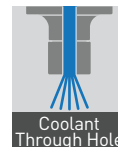

Model	Order No.	CK	ØD	ØD1	X	L	Insert Type
ID31-62CKB6	336.631	CKB6	31	63.5	62	100	WC 06
ID31-93CKB6	336.731	CKB6	31	63.5	93	130	WC 06
ID32-64CKB6	336.632	CKB6	32	63.5	64	100	WC 06
ID32-96CKB6	336.732	CKB6	32	63.5	96	130	WC 06
ID33-66CKB6	336.633	CKB6	33	63.5	66	110	WC 06
ID33-99CKB6	336.733	CKB6	33	63.5	99	140	WC 06
ID34-68CKB6	336.634	CKB6	34	63.5	68	110	WC 06
ID34-102CKB6	336.734	CKB6	34	63.5	102	140	WC 06
ID35-70CKB6	336.635	CKB6	35	63.5	70	110	WC 06
ID35-105CKB6	336.735	CKB6	35	63.5	105	150	WC 06
ID36-72CKB6	336.636	CKB6	36	63.5	72	110	WC 06
ID36-108CKB6	336.736	CKB6	36	63.5	108	150	WC 06
ID37-74CKB6	336.637	CKB6	37	63.5	74	110	WC 06
ID37-111CKB6	336.737	CKB6	37	63.5	111	150	WC 06
ID38-76CKB6	336.638	CKB6	38	63.5	76	125	WC 06
ID38-114CKB6	336.738	CKB6	38	63.5	114	160	WC 06
ID39-78CKB6	336.639	CKB6	39	63.5	78	125	WC 06
ID39-117CKB6	336.739	CKB6	39	63.5	117	160	WC 06
ID40-80CKB6	336.640	CKB6	40	63.5	80	125	WC 06
ID40-120CKB6	336.740	CKB6	40	63.5	120	165	WC 06
ID41-82CKB6	336.641	CKB6	41	63.5	82	125	WC 06
ID41-123CKB6	336.741	CKB6	41	63.5	123	165	WC 06
ID42-84CKB6	336.642	CKB6	42	63.5	84	125	WC 06
ID42-126CKB6	336.742	CKB6	42	63.5	126	165	WC 06
ID43-86CKB6	336.643	CKB6	43	63.5	86	140	WC 06
ID43-129CKB6	336.743	CKB6	43	63.5	129	180	WC 06
ID44-88CKB6	336.644	CKB6	44	63.5	88	140	WC 06
ID44-132CKB6	336.744	CKB6	44	63.5	132	180	WC 06
ID45-90CKB6	336.645	CKB6	45	63.5	90	140	WC 08
ID45-135CKB6	336.745	CKB6	45	63.5	135	180	WC 08
ID47-94CKB6	336.647	CKB6	47	63.5	94	140	WC 08
ID47-141CKB6	336.747	CKB6	47	63.5	141	190	WC 08
ID49-98CKB6	336.649	CKB6	49	63.5	98	150	WC 08
ID49-147CKB6	336.749	CKB6	49	63.5	147	200	WC 08
ID51-102CKB6	336.651	CKB6	51	63.5	102	150	WC 08
ID51-153CKB6	336.751	CKB6	51	63.5	153	200	WC 08
ID53-106CKB6	336.653	CKB6	53	63.5	106	160	WC 08
ID53-159CKB6	336.753	CKB6	53	63.5	159	215	WC 08
ID55-110CKB6	336.655	CKB6	55	63.5	110	160	WC 08
ID55-165CK6	336.755	CK6	55	63.5	165	215	WC 08
ID57-114CKB6	336.657	CKB6	57	63.5	114	165	WC 08
ID57-171CKB6	336.757	CKB6	57	63.5	171	220	WC 08
ID59-118CKB6	336.659	CKB6	59	63.5	118	165	WC 08
ID59-177CKB6	336.759	CKB6	59	63.5	177	220	WC 08
ID61-122CKB6	336.661	CKB6	61	63.5	122	165	WC 10
ID61-183CKB6	336.761	CKB6	61	63.5	183	220	WC 10
ID69-153CKB6	336.569	CKB6	69	63.5	153	200	WC 10

1. Inserts are to be ordered separately.
2. Adjustable drill holder is recommended for clamping.

Indexable Insert Drills, Ø 19.5 - 74

Indexable insert drills for 2xD with CKB tool interface.

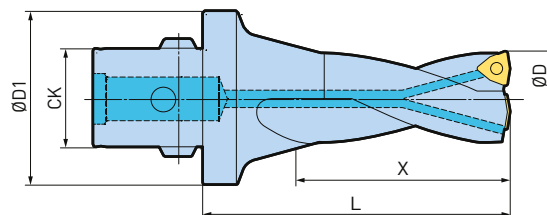
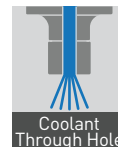

Model	Order No.	CK	ØD	ØD1	X	L	Inner Insert	Outer Insert
ID19.5-39CKB5	336.171	CKB5	19.5	50	39	75	WC 04	WC 03
ID25.5-56CKB5	336.172	CKB5	25.5	50	56	90	WC 05	WC 04
ID29.5-65CKB5	336.173	CKB5	29.5	50	65	100	WC 05	WC 05
ID34.5-76CKB5	336.174	CKB5	34.5	50	76	110	WC 06	WC 06
ID39.5-87CKB5	336.175	CKB5	39.5	50	87	125	WC 06	WC 06

1. Inserts are to be ordered separately.

C.2

Accessories & Spare Parts

Wrench	Insert Clamping Screw	Inserts WC	CK Shank BBT	CK Shank BDV	CK Shank HSK
					
▶ 514	▶ 514	▶ 470	▶ 91	▶ 142	▶ 191

Adjustable Drill Holders for Indexable Drill

Drill holders with for stepless diameter adjustment of BIG KAISER insert drills with CKB6 tool interface.

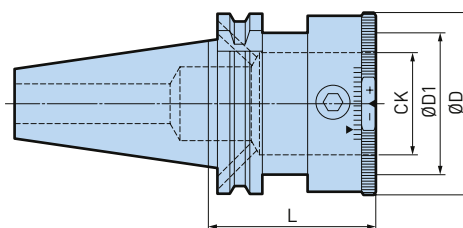
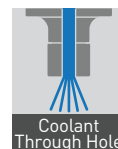

Fig. 1

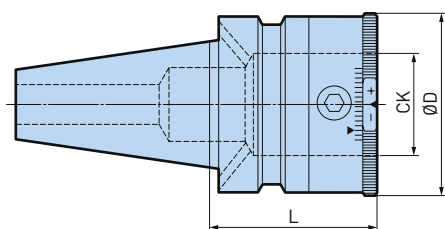

Fig. 2

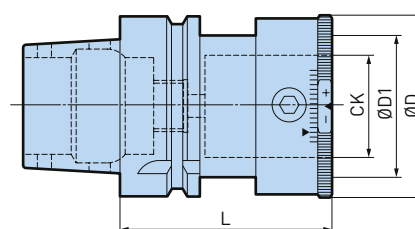

Fig. 3

Model	Order No.	Fig.	ØD	ØD1	L	Connection
BT40-ADH-CKB6ADF	336.302	2	65	-	51	CKB6
BT50-ADH-CKB6ADF	336.304	2	65	-	72	CKB6
DV40-ADH-CKB6ADF	336.301	1	65	50	59	CKB6
DV50-ADH-CKB6ADF	336.303	1	65	-	69	CKB6
HSK-A63-ADH-CKB6	336.309	3	65	52.5	70	CKB6
HSK-A100-ADH-CKB6	336.310	3	65	-	83	CKB6

1. Coolant pipe (CL) is to be ordered separately.
2. Adjustable range: nominal dia. $\varnothing + 1.0/-0.2$ mm

Accessories & Spare Parts

Grub screw



► 500

Off-Axis Use Instructions

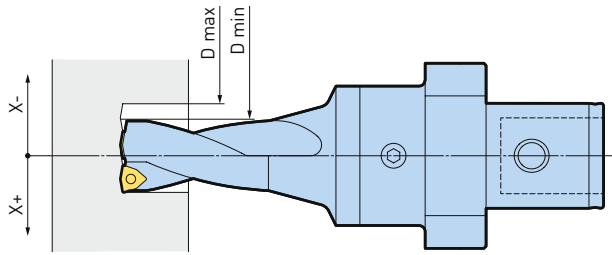

Drill Ø	Difficult work			Favourable work		
	+X	D min.	D max.	+X	D min.	D max.
16	1.0	16.0	18.0	1.7	16.0	19.4
17	0.8	17.0	18.6	1.5	17.0	20.0
18	0.7	18.0	19.4	1.3	18.0	20.6
19	0.5	19.0	20.0	1.0	19.0	20.6
20	0.3	20.0	20.6	0.8	20.0	21.6
21	1.1	21.0	23.2	2.0	21.0	25.0
22	0.9	22.0	23.8	1.7	22.0	25.4
23	0.8	23.0	24.6	1.5	23.0	26.0
24	0.6	24.0	25.2	1.2	24.0	26.4
25	0.4	25.0	25.8	1.0	25.0	27.0
26	1.0	26.0	28.0	1.7	26.0	29.4
27	0.8	27.0	28.6	1.4	27.0	29.8
28	0.6	28.0	29.2	1.2	28.0	30.4
29	0.4	29.0	29.8	0.9	29.0	30.8
30	0.3	30.0	30.6	0.7	30.0	31.4

Drill Ø	Adjustable Range		Boring Dia	
	-X	+X	D min.	D max.
31	0.25	3.5	30.5	38.0
32		3.25	31.5	38.5
33		3.0	32.5	39.0
34		2.75	33.5	39.5
35		2.5	34.5	40.0
36		2.25	35.5	40.5
37		2.0	36.5	41.0
38		1.75	37.5	41.5
39		1.5	38.5	42.0
40		1.25	39.5	42.5
41		1.0	40.5	43.0
42		0.75	41.5	43.5
43		0.5	42.5	44.0
44		0.25	43.5	44.5
45	0.5	4.0	44.0	53.0
47		3.5	46.0	54.0
49		3.0	48.0	55.0
51		2.5	50.0	56.0
53		2.0	52.0	57.0
55		1.5	54.0	58.0
57		1.0	56.0	59.0
59		0.5	58.0	60.0
61		3.5	60.0	68.0
65		3.0	64.0	71.0
69		2.0	68.0	73.0
74		1.0	73.0	76.0

1. * Adjustment range with adjustable drill holder or with stationary off axis use.

Driving power

Vc=220 m/min; Material St 60
kc 1 = 2110 N/mm²

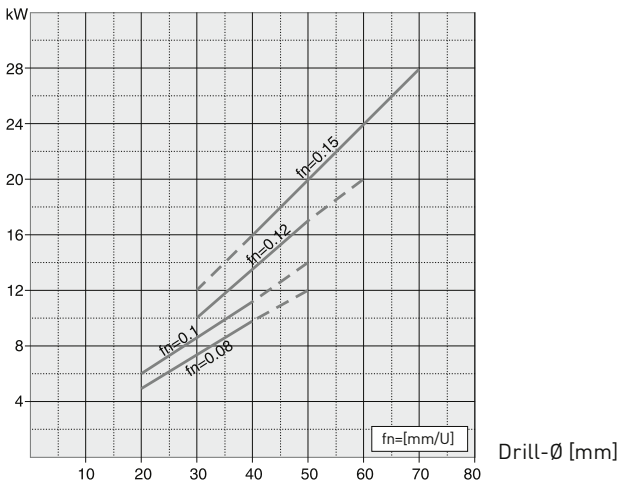

Feed force

Material St 60
kc 1 = 2110 N/mm²

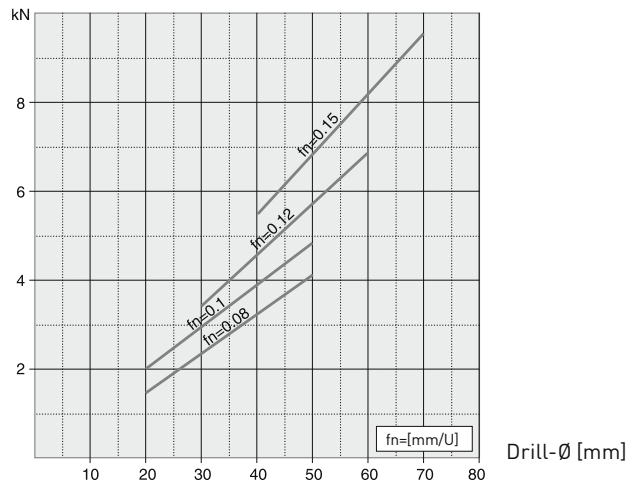

C.2

C-Cutter Standard Type

One C-Cutter to cover a wide chamfering range 45°: Ø 5 - Ø 25, Ø 10 - Ø 40, Ø 30 - Ø 60, Ø 50 - Ø 100

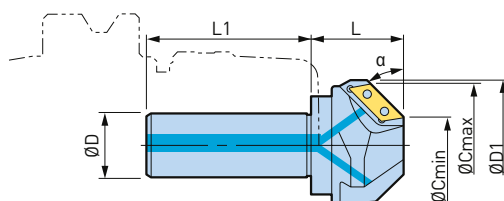
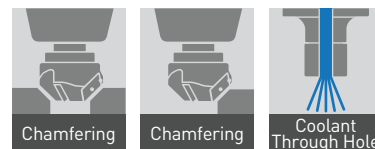

Model	Order No.	ØD	ØD1	L	L1	α	ØC min.	ØC max.	Number of Inserts	Insert Type
ST20-C0525C	966.401	20	33	25	60	45°	5	25	1	CW12
ST25-C1040C	966.406	25	45	35	70	45°	10	40	2	CW19
ST32-C3060C	802.224	32	65	45	80	45°	30	60	3	CW19
ST42-C50100C	966.404	42	106	70	80	45°	50	100	3	CW31
ST25-C1434C-60	966.405	25	38	37	70	60°	14	34	2	CW19
ST32-C1652C-30	978.336	32	68	48	80	30°	16	52	2	CW19
ST32-C3050C-60	978.338	32	54	45	80	60°	30	50	3	CW19
ST32-C4565C-60	978.339	32	69	50	80	60°	45	65	3	CW19
ST42-C5085C-30	802.251	42	96	52	80	30°	50	85	3	CW19

1. Wrench and screws are included.
2. Inserts are to be ordered separately.

C-Cutter CKB type

Chamfering mill with indexable inserts for efficient and vibration-free 45° chamfering. The long cutting edge provides a wide chamfering range which reduces the number of tools, tool changes and magazine space.

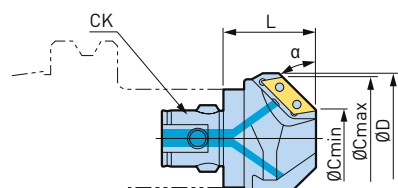
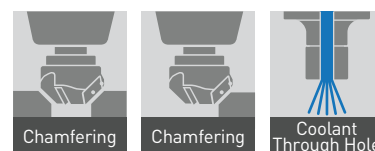

Accessories & Spare Parts



Model	Order No.	CK	ØD	L	α	ØC min.	ØC max.	Number of Inserts	Insert Type
CKB2-C0525C	335.021	CKB2	28.5	25	45°	5	25	1	CW12
CKB4-C1040C	335.022	CKB4	45	35	45°	10	40	2	CW19
CKB5-C3060C	335.023	CKB5	65	40	45°	30	60	3	CW19
CKB6-C50100C	335.024	CKB6	106	65	45°	50	100	3	CW31

1. Wrench and screws are included.
2. Inserts are to be ordered separately.

C-Cutter Universal Type

Chamfering angle adjustment from 5° to 85° with a hex key.

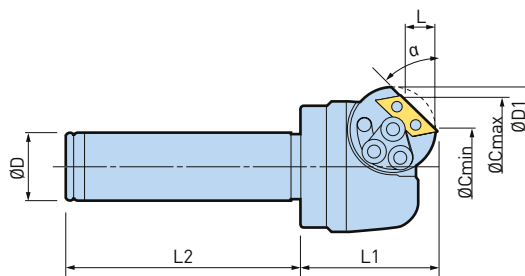
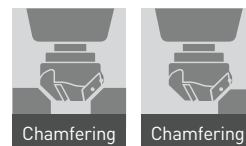

Model	Order No.	ØD	ØD1	L	L1	L2	α	ØC min.	ØC max.	Insert Type
ST20-C5/85A-40	966.407	20	49	1.2 - 12.7	40	70	5° - 85°	5.5	42.4	CW1206A

1. Wrench and screws are included.
2. Inserts are to be ordered separately.

Easy angle adjustment with a hex key.



Chamfering range

Angle θ	Chamfer		L
	ØC min	ØC max	
5°	5.5	33.5	1.2
10°	7.3	34.7	2.4
15°	9.0	36.2	3.6
20°	11.2	37.4	4.7
25°	13.0	38.6	5.9
30°	15.2	39.6	7.0
35°	17.4	40.5	8.0
40°	19.6	41.2	9.0
45°	21.8	41.8	10.0

Angle θ	Chamfer		L
	ØC min	ØC max	
50°	24.0	42.2	10.8
55°	26.4	42.4	11.4
60°	28.5	42.5	12.1
65°	30.7	42.4	12.5
70°	32.9	42.1	12.6
75°	34.9	41.7	12.7
80°	36.9	41.1	11.9
85°	38.8	40.3	8.6

1. Values in the table are reference only. Measure accurate values with a presetter.

Accessories & Spare Parts

<p>Inserts for C-Cutter</p> <p>► 553</p>	<p>Insert Clamping Screw Set</p> <p>► 553</p>
--	---

Inserts for C-Cutter

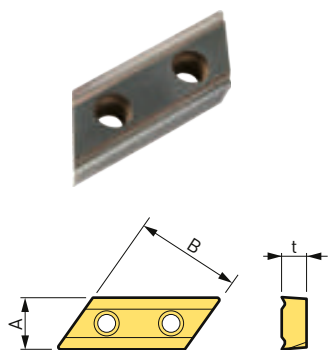

ZX = TiCN+TiAlN multilayer coating

Model	A	B	t	P30	P20	N20
				Non-Coat	ZX	DLC
CW1206A	6.35	12.7	2.7	978.283	800.951	801.753
CW1206A-10P				802.134	978.918	-
CW1909A	9.525	19.05	4.5	978.817	800.952	801.754
CW1909A-10P				802.135	802.136	-
CW3115A	15.875	31.75	7.0	978.826	800.953	801.755
CW3115A-10P				802.137	802.138	-

1. 10P: Set contains 10 inserts.
2. DLC coated insert is only available with 1 pce.

Non-coating	Adopts P30-equivalent carbide material with emphasis on toughness for versatile use with materials from steel to aluminum.
ZX Coating	TiN and AlN multilayer coating increases speeds and extends insert life in chamfering of steel or cast iron.
DLC Coating	The exclusive substrate is treated with a thin DLC coating to prevent welding during aluminum machining. It retains sharpness and achieves a clean surface finish.

Insert Clamping Screw Set



Insert	Set Model	Order No.
CW1206A	S2S-B	978.284
CW1909A	S3S	801.696
CW3115A	S5S	801.699

1. The set contains 10 screws and 1 wrench.
2. Wrenches are also available separately.

C-Cutter

Recommended Cutting Condition

Cutter Type	Max. Chamfer	Chamfering	General Steel Alloy Steel		Stainless Steel		Cast Iron		Aluminium	
			Vc (m/min)	f (mm/rev)	Vc (m/min)	f (mm/rev)	Vc (m/min)	f (mm/rev)	Vc (m/min)	f (mm/rev)
ST20-C5/85A-40	2 mm *	Plunge Cutting	50	0.1	30	0.08	40	0.1	80	0.1
		Side Cutting	80	0.15	60	0.1	50	0.15	100	0.2
C0525C	C2	Plunge Cutting	50	0.1	30	0.08	40	0.1	80	0.1
		Side Cutting	80	0.15	60	0.1	50	0.15	100	0.15
C1040C	C3	Plunge Cutting	90	0.15	40	0.12	60	0.15	100	0.2
C1434C-60 C1652C-30	3 mm *	Side Cutting	120	0.3	60	0.2	90	0.3	150	0.3
C3060C / C3060	C4	Plunge Cutting	120	0.3	60	0.18	90	0.25	150	0.3
C3050C-60 C4565C-60 C5085C-30	4 mm *	Side Cutting	150	0.45	60	0.3	120	0.6	200	0.6
C50100C	C4	Plunge Cutting	150	0.4	80	0.25	120	0.35	180	0.4
		Side Cutting	150	0.45	60	0.36	120	0.6	240	0.6

Vc: Cutting speed (m/min.) f: Feed per revolution (mm/rev.)

1. Cutting condition is the same for both non-coated and coated inserts. Coated inserts will achieve better surface finish and extended insert life.
2. Peck feed is necessary in case cutting chips are too long.
3. Reduce cutting speed if a larger chamfer than the max. amount shown in the table is required.
4. A high rigidity toolholder is recommended, such as BIG KAISER HMC or MEGA D Chuck.
5. Max. chamfering amount with * in 30, 60 degree type and Universal type indicates the chamfering length of the longer side.

Application Example

C3 traverse chamfering. Workmaterial: C55 (S55C)

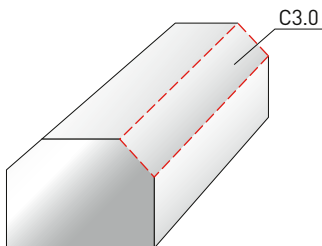

High cutting parameter was achieved without chattering

C-Cutter	ST25-C1040
Insert Model	CW1909A
Spindle speed	3 000 min ⁻¹
Feed	1 800 mm/min

Accessories & Spare Parts

<p>Indexable Inserts for C-Cutter Mini</p>  <p>► 561</p>	<p>Insert Clamping Screw Set</p>  <p>► 561</p>
---	---

C-Cutter Mini, Multi Insert Type

Front & Back Chamfering

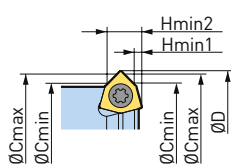
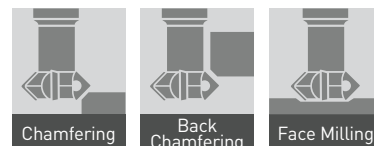

Fig. 1

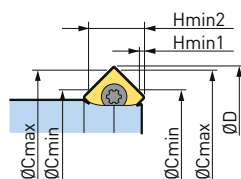

Fig. 2

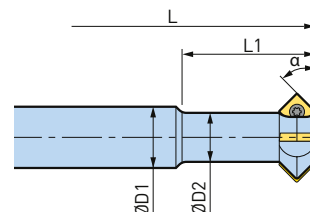

Fig. 3

Model	Order No.	Fig.	ØD	ØD1	ØD2	L	L1	α	ØC min.	ØC max.	H min1	H min2	Insert Type
ST10-C0810-45B-15	807.192	1	10.5	10	7.4	78	15	45°	8	10	0.7	3.2	CM03
ST10-C0810-45B-27	807.193	1	10.5	10	7.4	90	27	45°	8	10	0.7	3.2	CM03
ST12-C1012-45B-20	966.461	1	12.7	12	9	93	20	45°	10	12	1	3.7	CM04
ST12-C1012-45B-35	966.462	1	12.7	12	9	108	35	45°	10	12	1	3.7	CM04
ST12-C1116-45B-25	966.433	2	17.1	12	9.6	98	25	45°	11	16	0.4	6.2	CM05
ST12-C1116-45B-40	966.463	2	17.1	12	9.6	113	40	45°	11	16	0.4	6.2	CM05
ST16-C1520-45B-50	966.464	2	20.7	16	13.2	123	50	45°	15	20	0.6	6.3	CM05
ST20-C1924-45B-60	966.465	2	24.7	20	17.2	143	60	45°	19	24	0.6	6.3	CM05
ST20-C2232-45B-50	966.434	3	32.7	20	19.2	130	50	45°	22	32	0.4	12.4	CM10
ST20-C2232-45B-80	966.466	3	32.7	20	19.2	160	80	45°	22	32	0.4	12.4	CM10
ST32-C3242-45B-65	966.435	3	42.7	32	30.6	175	65	45°	32	42	0.4	12.4	CM10
ST32-C3242-45B-100	966.467	3	42.7	32	30.6	211	100	45°	32	42	0.4	12.4	CM10

1. Wrench and screws are included.
2. Inserts are to be ordered separately.
3. In case of chamfering with 4 insert type, chatter may occur due to increased L1 cutting resistance when plunge cutting. Please try the different types with less inserts, 1 or 2.

Accessories & Spare Parts

<p>Indexable Inserts for C-Cutter Mini</p>  <p>► 561</p>	<p>Insert Clamping Screw Set</p>  <p>► 561</p>
---	---

C-Cutter Mini, Single Insert Type

Front & Back Chamfering

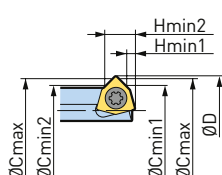
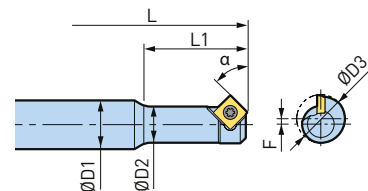

Fig. 1

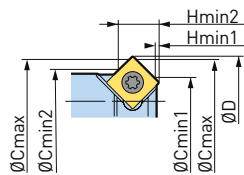

Fig. 2

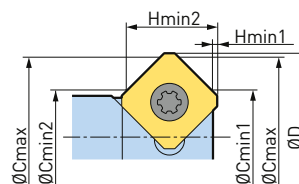

Fig. 3

Model	Order No.	Fig.	ØD	ØD1	ØD2	ØD3	L	L1	ØC min1	ØC min2	ØC max.	H min1	H min2	F	α	Insert Type
ST10-C0409-45B-20	966.469	2	9.8	10	5.4	7.7	86	20	4	6	9	0.5	5.4	1.1	45°	CM05
ST10-C0608-45B-16	966.468	1	8.8	10	5.7	5.7	78	16	6	6	8	1	3.8	1.55	45°	CM04
ST10-C0611-45B-20	966.432	2	12	10	7.4	9.8	81	20	6	8	11	0.4	5.5	1.1	45°	CM05
ST10-C0611-45B-35	966.470	2	12	10	7.4	9.8	96	35	6	8	11	0.4	5.5	1.1	45°	CM05
ST16-C1222-45B-40	966.471	3	22.6	16	11	16.9	117	40	12	12	22	0.3	12.4	2.9	45°	CM10

1. Wrench and screws are included.
2. Inserts are to be ordered separately.

C.2

Accessories & Spare Parts

<p>Indexable Inserts for C-Cutter Mini</p> <p>► 561</p>	<p>Insert Clamping Screw Set</p> <p>► 561</p>
---	---



C-Cutter Mini, Single Insert Type

Front Chamfering

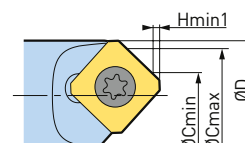
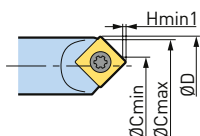
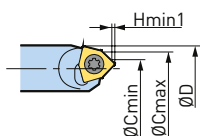
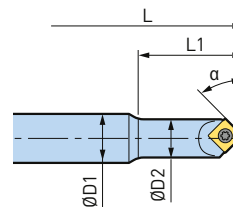

Fig. 1

Fig. 2

Fig. 3

Model	Order No.	Fig.	ØD	ØD1	ØD2	L	L1	α	ØC min.	ØC max.	H min1	Insert Type
ST8-C0103-45-16	807.196	1	4.9	8	4.7	68	16	45°	1	3	0.3	CM03
ST10-C0204-45-15	966.486	1	6.3	10	6	78	15	45°	2	4	0.4	CM04
ST10-C0204-45-25	966.487	1	6.3	10	6	88	25	45°	2	4	0.4	CM04
ST10-C0207-45-20	966.431	2	8.1	10	7.8	81	20	45°	2	7	0.4	CM05
ST10-C0207-45-35	966.488	2	8.1	10	7.8	96	35	45°	2	7	0.4	CM05
ST16-C0214-30-40	966.436	3	15.9	16	15.4	105	40	30°	2	14	0.2	CM10
ST16-C0515-45-50	966.489	3	15.8	16	15.2	122	50	45°	5	15	0.4	CM10
ST16-C0916-60-40	966.437	3	16.5	16	15.6	105	40	60°	9	16	0.8	CM10

1. Wrench and screws are included.
2. Inserts are to be ordered separately.

Accessories & Spare Parts

<p>Indexable Inserts for C-Cutter Mini</p> <p>► 561</p>	<p>Insert Clamping Screw Set</p> <p>► 561</p>
---	---

C-Cutter Mini, Single Insert Type

Bolt Hole & Tap Starting Hole -Front & Back Chamfer

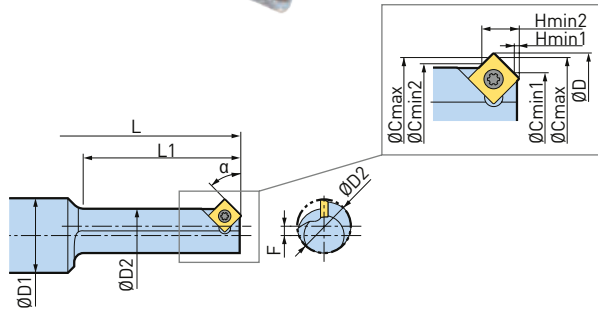
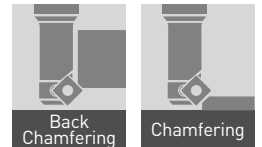

Fig. 1

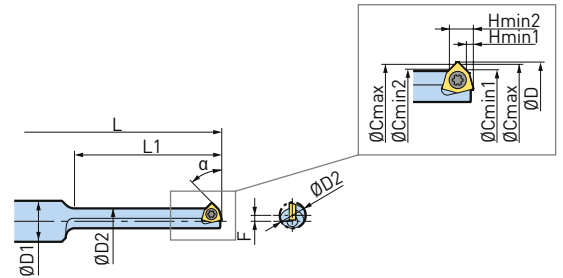

Fig. 2

Model	Order No.	Fig.	ØD	ØD1	ØD2	L	L1	ØC min1	ØC min2	ØC max.	H min1	H min2	F	Insert Type
ST8-CM06-45B-14	807.194	1	7	8	4.6	66	14	4.9	4.9	6.3	0.9	3.1	1.2	CM03
ST8-CM06-45B-26	807.195	1	7	8	4.6	78	26	4.9	4.9	6.3	0.9	3.1	1.2	CM03
ST10-CM08-45B-19	966.472	1	9.2	10	6.3	81	19	6.4	6.6	8.4	1	3.7	1.45	CM04
ST10-CM08-45B-35	966.473	1	9.2	10	6.3	97	35	6.4	6.6	8.4	1	3.7	1.45	CM04
ST12-CM10-45B-25	966.474	2	11.3	12	8	99	25	5.5	8.3	10.5	0.5	5	1.65	CM05
ST12-CM10-45B-45	966.475	2	11.3	12	8	119	45	5.5	8.3	10.5	0.5	5	1.65	CM05
ST12-CM12-45B-29	966.476	2	13.4	12	9.7	102	29	7.6	10.0	12.6	0.5	5.2	1.85	CM05
ST12-CM12-45B-53	966.477	2	13.4	12	9.7	126	53	7.6	10	12.6	0.5	5.2	1.85	CM05
ST16-CM14-45B-33	966.478	2	15.5	16	11.5	107	33	9.7	11.8	14.7	0.5	5.3	2	CM05
ST16-CM14-45B-61	966.479	2	15.5	16	11.5	135	61	9.7	11.8	14.7	0.5	5.3	2	CM05
ST16-CM16-45B-37	966.480	2	17.6	16	13.5	110	37	11.8	13.8	16.8	0.5	5.4	2.05	CM05
ST16-CM16-45B-69	966.481	2	17.6	16	13.5	142	69	11.8	13.8	16.8	0.5	5.4	2.05	CM05
ST20-CM18-45B-42	966.482	2	19.7	20	14.9	126	42	13.9	15.2	18.9	0.5	5.7	2.4	CM05
ST20-CM18-45B-78	966.483	2	19.7	20	14.9	162	78	13.9	15.2	18.9	0.5	5.7	2.4	CM05
ST20-CM20-45B-46	966.484	2	21.8	20	16.9	129	46	16	17.2	21	0.5	5.8	2.45	CM05
ST20-CM20-45B-86	966.485	2	21.8	20	16.9	169	86	16	17.2	21	0.5	5.8	2.45	CM05

1. Wrench and screws are included.
2. Inserts are to be ordered separately.

C.2

Accessories & Spare Parts

<p>Indexable Inserts for C-Cutter Mini</p> <p>► 561</p>	<p>Insert Clamping Screw Set</p> <p>► 561</p>
---	---

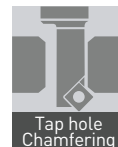

C-Cutter Mini, Single Insert Type

Back Chamfering

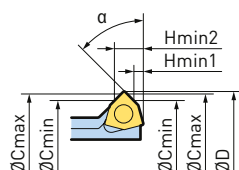
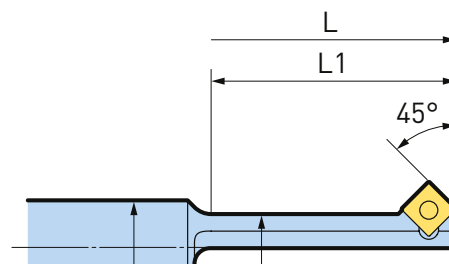

Fig. 1

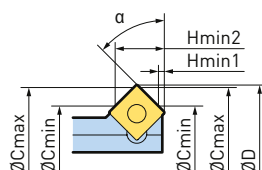

Fig. 2

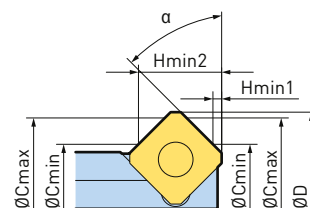

Fig. 3

Model	Order No.	Fig.	ØD	ØD1	ØD2	L	L1	α	ØC min.	ØC max.	H min1	H min2	F	Insert Type
ST10-CZ06-45B-23	806.966	1	12.8	10	6.1	85	23	45°	10	12	1	3.8	3.35	CM04
ST12-CZ08-45B-31	806.967	2	26.8	12	8.5	104	31	45°	11	16	0.5	6.3	4.15	CM05
ST16-CZ10-45B-37	806.968	2	20.3	16	10.5	111	37	45°	14.5	19.5	0.5	6.3	4.9	CM05
ST16-CZ12-45B-50	806.969	3	24.8	16	13.5	124	50	45°	14	24	0.3	12	5.65	CM10
ST20-CZ14-45B-56	806.970	3	27.8	20	15.5	139	56	45°	17	27	0.3	12	6.15	CM10

1. Wrench and screws are included.
2. Inserts are to be ordered separately.

Accessories & Spare Parts

<p>Indexable Inserts for C-Cutter Mini</p> <p>► 561</p>	<p>Insert Clamping Screw Set</p> <p>► 561</p>
---	---

C-Cutter Mini CKB Type

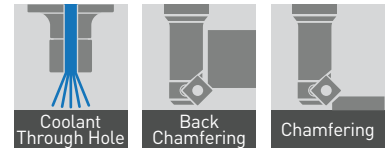
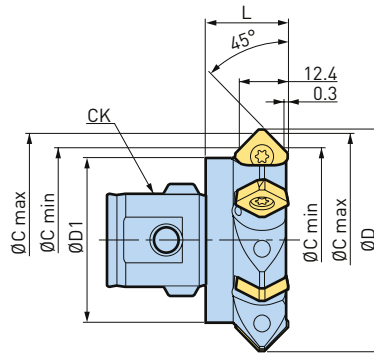

Model	Order No.	CK	ØD	ØD1	L	ØC min.	ØC max.	Number of Inserts	Insert Type
CKB1-C2232-45B-20	335.070	CKB1	32.7	19	20	22	32	4	CM10
CKB3-C3242-45B-20	335.071	CKB3	42.7	31	20	32	42	4	CM10
CKB3-C5262-45B-20	335.072	CKB3	62.7	31	20	52	62	6	CM10
CKB4-C4252-45B-20	335.073	CKB4	52.7	39	20	42	52	6	CM10
CKB5-C5262-45B-20	335.074	CKB5	62.7	51	20	52	62	6	CM10

1. Wrench and screws are included.
2. Inserts are to be ordered separately.

C-Cutter Mini Universal

Slim body C-Cutter with chamfering angle adjustment from 5° to 85°.

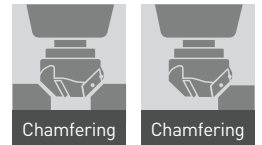
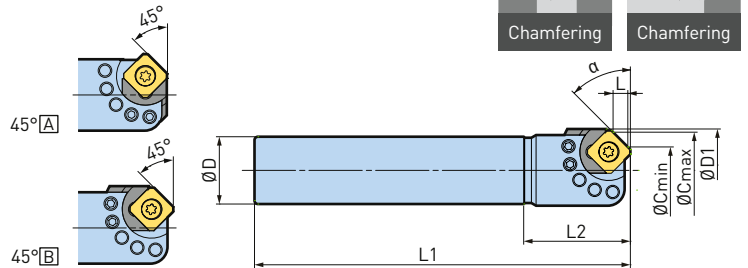
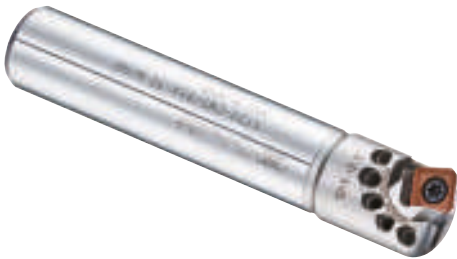

Model	Order No.	ØD	ØD1	L	L1	L2	α	ØC min.	ØC max.	Insert Type
ST20-CM5/85A-30	806.541	20	25	0.6 - 6.8	112	32	5° - 85°	5.7	23.3	CM10C1

1. Wrench and screws are included.
2. Inserts are to be ordered separately.

Application examples

47.5° chamfer
Plunging



5° chamfer
Traverse



C.2

Chamfering Range

Chamfering angle θ	Min. hole ØC min	Max. chamfer diameter ØC max	L
5°	5.7	18.8	0.6
10°	6.7	19.7	1.2
15°	7.6	20.5	1.7
20°	8.5	21.2	2.3
25°	9.6	21.8	2.9
30°	10.6	22.3	3.4
35°	11.6	22.7	3.9
40°	12.7	23.0	4.4
45° A	13.7	23.3	4.8
45° B	13.4	23.0	4.8

Chamfering angle θ	Min. hole ØC min	Max. chamfer diameter ØC max	L
50°	14.4	23.2	5.2
55°	15.5	23.3	5.6
60°	16.4	23.3	5.9
65°	17.4	23.2	6.2
70°	18.3	23.0	6.4
75°	19.1	22.7	6.6
80°	19.9	22.3	6.7
85°	20.7	21.9	6.8

Values in the table are reference only. Measure accurate values with a presetter.

Indexable Inserts for C-Cutter Mini

Indexable Inserts

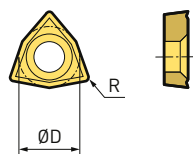

Fig. 1

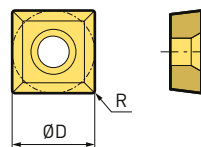

Fig. 2

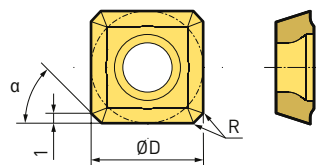

Fig. 3

The suffix SE designates a sharp cutting edge version.

Model	Fig.	ØD	Nose R	P		M	K	N	Clamping Screw Set	
				ACP200	ACP300	ACM250F	NF15KA	DS20	Model	Order No.
CM0302	1	3.31	0.2	-	807.226	807.448	-	807.449	S1.6S-T3	807.041
CM0402		3.97	0.2	-	966.440	807.450	-	807.451	S2SS-T6	966.448
CM0502	2	5	0.2	966.441	-	807.187	807.683	966.442	S2TS-T6	966.449
CM0502SE				966.443	800.950	-	-	-		
CM10C1	3	10	0.2	966.445	-	807.188	807.684	966.446	S4S-T15	966.450
CM10C1SE				966.447	-	-	-	-		

1. Inserts are available in packets of 10 pcs.
2. It is recommended to regularly replace clamping screws and wrench to ensure the correct clamping force is maintained.

Sharp cutting edge insert for „SE“ type

Sharp cutting edge minimises the generation of burrs. This is especially beneficial when cutting stainless and mild steel materials.



Recommended Cutting Condition

A (Standard conditions)

Work Material	Insert Grade	Cutting Speed Vc (m/min)	Feed Rate fz (mm/tooth)		Coolant
			Chamfering	Face Milling (CM10 insert only)	
General Steel, Alloy Steel, High-Alloy Steel	ACP200	100 - 350	0.05 - 0.4	0.05 - 0.2	Dry
Prehardened Steel (Less than HRC40)	ACP300	60 - 100	0.05 - 0.1	0.05 - 0.1	Wet
Cast Iron	NF15KA	100 - 350	0.1 - 0.5	0.05 - 0.25	Dry
Stainless Steel	ACM250F	100 - 250	0.08 - 0.3	0.08 - 0.2	Dry / Wet
Aluminium, Non-Ferrous	DS20, ACP300	100 - 800	0.1 - 0.5	0.05 - 0.3	Dry / Wet

1. The table is just a reference to determine cutting conditions. It should be adjusted according to the condition of the machine tool and workpiece.
2. Wet cutting is recommended to obtain the good surface quality.
3. In case built-up edge occurs when cutting aluminum and stainless steel, use soluble oil.

B (For long models of „bolt hole and starting hole for tapping type“)

Work Material	Insert Grade	Cutting Speed Vc (m/min)	Feed Rate fz (mm/tooth)	Coolant
General Steel, Alloy Steel, High-Alloy Steel	ACP200 ACP300	20 - 100	0.03 - 0.12	Wet
Cast Iron	NF15KA	50 - 160	0.05 - 0.20	Dry
Aluminium, Non-Ferrous	DS20, ACP300	30 - 100	0.03 - 0.12	Wet

1. The table is just a reference to determine cutting conditions. It should be adjusted according to the condition of the machine tool and workpiece.
2. For stainless steel and hardened steel, shorter models are recommended.

Application Examples C-Cutter Mini

Front & Back chamfering for stainless steel

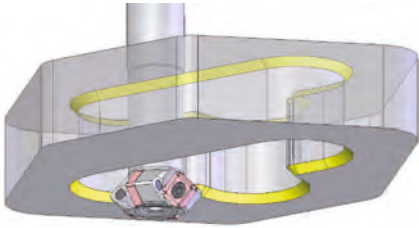

Material: X5CrNi18-9
 Chamfer: 3 mm x 45°
 Feed: 0.1 mm/tooth

	Competitor's Tool (with TiAlN Coated Carbide Insert)	C-Cutter Mini (ST20-C2232-45B-50)
Chamfering Dia.	Ø 30	Ø 28
Number of Teeth	1	4
Cutting Speed (m/min)	140	180
Spindle Speed (min ⁻¹)	1490	2050
Feed (mm/min)	149	819
Result	5 times better cutting efficiency	

Chamfering for aluminium

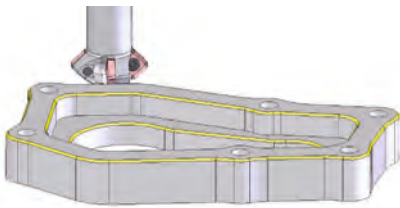

Material: Al-Si7Mg(Fe)
 Chamfer: 0.5 mm x 45°
 Feed: 0.1 mm/tooth

	Competitor's Tool	C-Cutter Mini (ST12-C1116-45B-25)
Chamfering Dia.	Ø 40	Ø 12
Number of Teeth	3	4
Cutting Speed (m/min)	200	600
Spindle Speed (min ⁻¹)	1590	15920
Feed (mm/min)	477	6370
Result	13 times better cutting efficiency	

Front & Back chamfering of starting holes for M8 tapping



Material: FC250
 Tapped hole: Ø 6.6
 Chamfering dia.: Ø 8.4

	Competitor's Tool (with Non-Coated Carbide Insert)	C-Cutter Mini (ST10-CM08-45B-19)
Cutting Speed (m/min)	30	150
Spindle Speed (min ⁻¹)	1140	5680
Feed per Tooth (mm/rev)	0.05	0.1
Feed (mm/min)	57	568

R-Cutter - Front & Back R Chamfering

Front & back R-chamfering are available. 4 inserts multiply feed rate.

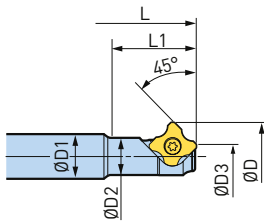

Fig. 1

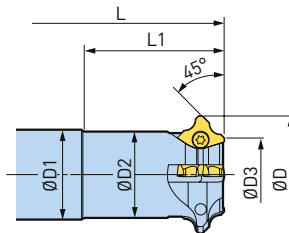
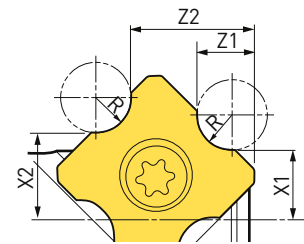

Fig. 2



Model	Order No.	Fig.	ØD	ØD1	ØD2	ØD3	L	L1	Number of Insert	R	X1	Z1	X2	Z2	Insert Model
ST10-RC061B-15	966.501	1	12.3	10	6.6	4.4	78	15	1	0.5	3.61	1.93	4.30	5.78	RC06
										1	3.35	2.18	4.04	5.53	
										1.5	3.09	2.43	3.78	5.28	
										2	2.83	2.68	3.52	5.03	
ST16-RC121B-30	966.502	1	24.4	16	13.3	8.6	103	30	1	1	7.17	3.79	8.56	11.63	RC12
										2	6.65	4.29	8.03	11.13	
										3	6.13	4.79	7.51	10.63	
										4	5.60	5.29	6.99	10.13	
ST16-RC064B-30	966.503	2	21	16	15.2	13.2	101	30	4	0.5	7.89	1.93	8.59	5.78	RC06
										1	7.64	2.18	8.34	5.53	
										1.5	7.39	2.43	8.09	5.28	
										2	7.13	2.68	7.84	5.03	
ST32-RC124B-50	966.504	2	42	32	30.8	26.3	141	50	4	1	15.85	3.79	17.26	11.63	RC12
										2	15.33	4.29	16.75	11.13	
										3	14.83	4.79	16.24	10.63	
										4	14.31	5.29	15.73	10.13	

1. Wrench and screws are included.
2. Inserts are to be ordered separately.

Accessories & Spare Parts

<p>Indexable Inserts for R-Cutter</p> <p>► 566</p>	<p>Insert Clamping Screw Set</p> <p>► 566</p>
--	---

R-Cutter - Front Chamfering

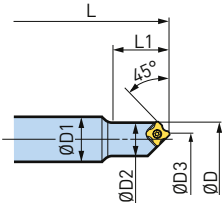

Fig. 1

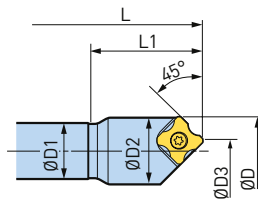
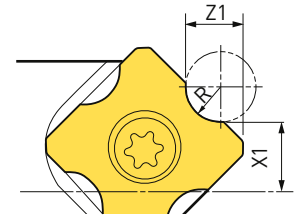

Fig. 2



Model	Order No.	Fig.	ØD	ØD1	ØD2	ØD3	L	L1	Number of Insert	R	X1	Z1	Insert Model
ST16-RC061-20	966.505	1	12.3	16	11.9	4.5	94	20	1	0.5	3.61	1.93	RC06
										1	3.35	2.18	
										1.5	3.09	2.43	
										2	2.83	2.68	
ST20-RC121-40	966.506	2	24.4	20	23.8	8.9	121	40	1	1	7.17	3.79	RC12
										2	6.65	4.29	
										3	6.13	4.79	
										4	5.60	5.29	

1. Wrench and screws are included.
2. Inserts are to be ordered separately.

C.2

Accessories & Spare Parts

<p>Indexable Inserts for R-Cutter</p>  <p>► 566</p>	<p>Insert Clamping Screw Set</p>  <p>► 566</p>
--	---

R-Cutter CKB Type

The R-Cutter is a high performance tool for chamfering, back chamfering and face milling. Due to the small tool diameter it permits extremely high feed rates.

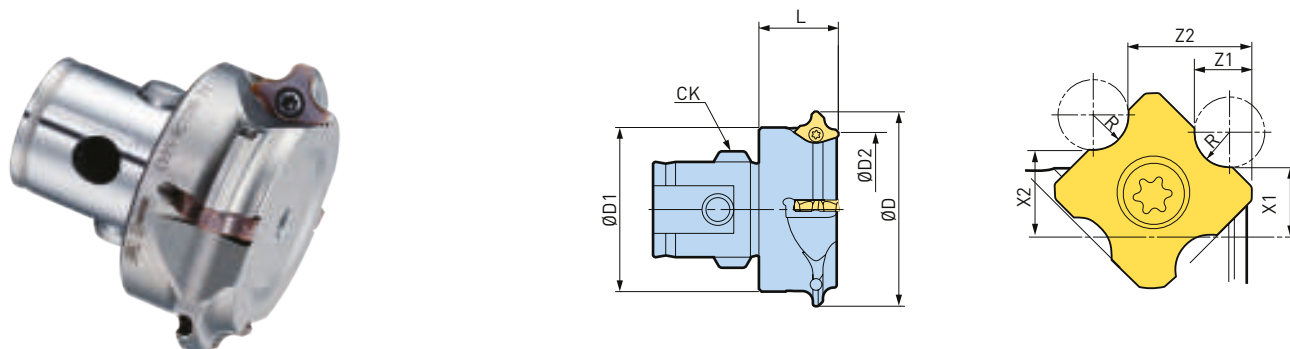
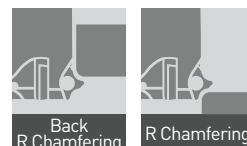

Model	Order No.	CK	ØD	ØD1	ØD2	L	R	X1	Z1	X2	Z2	Number of Inserts	Insert Model
CKB3-RC064B-15	806.439	CKB3	37	31	29.2	15	0.5	15.9	1.9	16.6	5.8	4	RC06
							1.0	15.6	2.2	16.3	5.5		
							1.5	15.4	2.4	16.1	5.3		
							2.0	15.1	2.7	15.8	5		
CKB5-RC124B-25	806.440	CKB5	62	50	46.3	25	1	25.8	3.8	27.2	11.6	4	RC12
							2	25.3	4.3	26.7	11.1		
							3	24.8	4.8	26.2	10.6		
							4	24.3	5.3	25.7	10.1		

1. Wrench and screws are included.
2. Inserts are to be ordered separately.

Accessories & Spare Parts

<p>Indexable Inserts for R-Cutter</p>  <p>► 566</p>	<p>Insert Clamping Screw Set</p>  <p>► 566</p>
--	---

Indexable Inserts for R-Cutter



Model	Order No.	Insert Grade	Insert Radius R	Insert Type
RC06050(ACP300)	966.530	ACP300	0.5	RC06
RC06100(ACP300)	966.531	ACP300	1	RC06
RC06150(ACP300)	966.532	ACP300	1.5	RC06
RC06200(ACP300)	966.533	ACP300	2	RC06
RC12100(ACP300)	966.534	ACP300	1	RC12
RC12200(ACP300)	966.535	ACP300	2	RC12
RC12300(ACP300)	966.536	ACP300	3	RC12
RC12400(ACP300)	966.537	ACP300	4	RC12

1. Inserts are available in a packet of 10 pcs.
2. Material is coated carbide.

Screw Set

Inserts	Model	Order No.
RC06	S2TS-T6	966.449
RC12	S4S-T15	966.450

1. Insert clamping set contains 10 pcs screw and 1 pcs wrench.

Recommended Cutting Condition

Workpiece Material	Cutting Speed (m/min)	Feed Rate (mm/tooth)	Coolant
Structural, Carbon or Alloy Steel	100 - 350	0.05 - 0.2	Dry
Prehardened Steel (less than HRC40)	60 - 80	0.05 - 0.1	Wet
Stainless Steel	100 - 250	0.08 - 0.2	Dry / Wet
Cast Iron	100 - 350	0.05 - 0.25	Dry
Aluminium	100 - 800	0.05 - 0.25	Dry / Wet

1. The table is a reference to determine cutting conditions. It should be adjusted according to the condition of the machine tool and workpiece.
2. Wet cutting is generally recommended to obtain good surface quality.
3. In case of built-up edge occurs when cutting aluminum and stainless steel, use soluble oil.

C-Centering Cutter

A multifunction cutter capable of both spot drilling and chamfering.

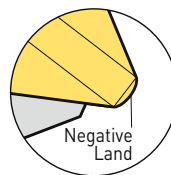

As the nose radius on the insert forms negative land, it has high chipping resistance, and the tool life is significantly extended.

Spot Drilling Depth Calculation Method

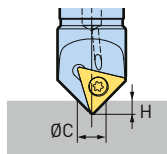

$$\langle \theta_i = 90^\circ \rangle$$

$$H = (\phi C - \phi C_{min}) \div 2 + H_{min}$$

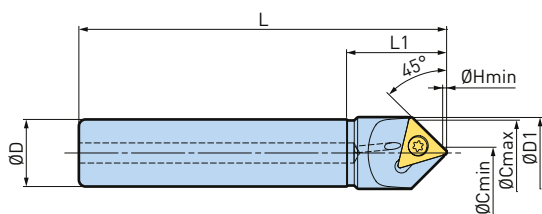

Fig. 1

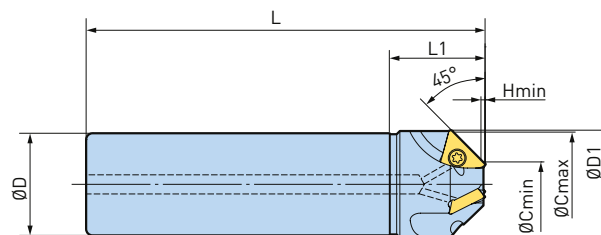
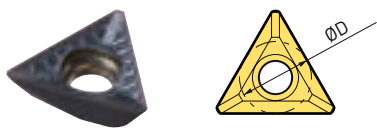

Fig. 2

Model	Order No.	Fig.	ØD	ØD1	L	L1	ØC min.	ØC max.	H min	Insert Type
ST8-CN0209-45-65	807.685	1	8	10	65	15	2	9	0.6	CN0406
ST12-CN0213-45-90	807.686	1	12	14	90	20	2	13	0.6	CN0606
ST20-CN0220-45-110	806.622	1	20	22	110	30	2	20	0.6	CN0906
ST32-CN1433-45-125	807.015	2	32	34	125	30	14	33	0.6	CN0906

1. Wrench and screws are included.
2. Inserts are to be ordered separately.

Inserts for C-Centering Cutter



Model	Inscribed Circle ØD	Insert Grade			Insert Clamp Screw Set Model	Wrench Model
		Durability-focused ACM250F (for steel, stainless steel, cast iron)	Burr prevention ACZ150 (for steel, structural steel, cast iron)	For non-ferrous metals DS20 (for aluminum)		
CN0406	4.76	807.687	807.689	807.688	S2TS-6IP	FS-6IP
CN0606	6.35	807.690	807.692	807.691	S2.5S-8IP	FS-8IP
CN0906	9.525	807.139	807.693	807.158	S4S-15IP	FS-15IP

Clamping Screw Set	Order No.
S2TS-6IP	807.694
S2.5S-8IP	807.695
S4S-15IP	806.624

1. Insert clamping set contains 10 pcs screw and 1 pcs wrench.

Recommended Cutting Condition

Workpiece Material	Cutting Speed Vc (m/min)	Feed (mmv/rev)	
		Spot Drilling	Traverse Chamfering
Carbon Steel, Alloy Steel	50 - 150	0.02 - 0.08	0.05 - 0.2
Stainless Steel	50 - 120	0.02 - 0.05	
Cast Iron	70 - 200	0.02 - 0.08	
Aluminum	100 - 300		

1. The table is just a reference to determine cutting conditions.
2. It should be adjusted according to the condition of the machine tool and workpiece.

Center Boy

Accurate centering and chamfering in one single operation.

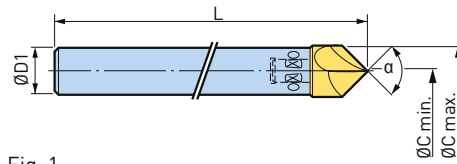
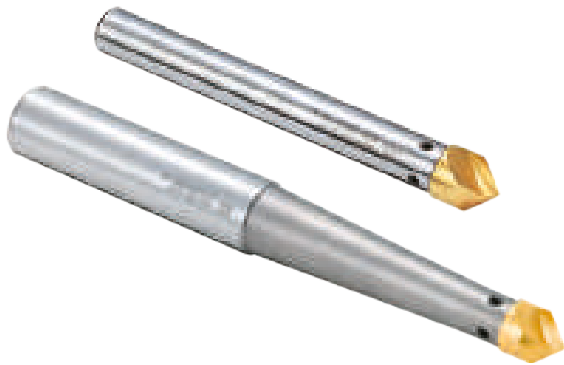

Fig. 1

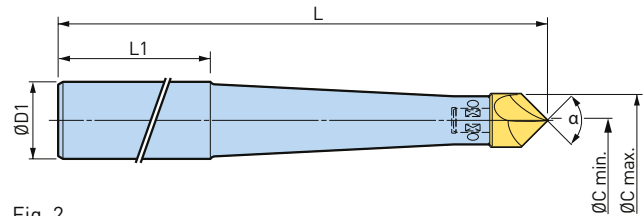

Fig. 2

Model	Order No.	Fig.	$\varnothing D1$	L	L1	α	$\varnothing C \text{ min.}$	$\varnothing C \text{ max.}$	Indexable Bit	Locking Screw
ST10-CBY09010	966.415	1	10	150	-	90°	0.9	10	CBY09010	H0403-5P
ST12-CBY09013	966.416	1	12	150	-	90°	0.9	13	CBY09013	H0403-5P
ST16-CBY09016	966.417	1	16	180	-	90°	1	16	CBY09016	H0504-5P
ST20-CBY09022	966.418	1	20	180	-	90°	1.5	22	CBY09022	H0505-5P
ST12-CBY12013	802.756	1	12	150	-	120°	0.9	13	CBY12013	H0403-5P
ST20-CBY09013-220	966.411	2	20	220	120	90°	0.9	13	CBY09013	H0403-5P
ST20-CBY09013-260	966.412	2	20	260	120	90°	0.9	13	CBY09013	H0403-5P
ST32-CBY09022-260	966.413	2	32	260	120	90°	1.5	22	CBY09022	H0505-5P
ST32-CBY09022-300	966.414	2	32	300	120	90°	1.5	22	CBY09022	H0505-5P

- 2 pcs of indexable Bits and 2 pcs of locking screws are included as standard accessories.
- Spare locking screws are available in a packet of 5 pcs.

Indexable Bit for Center Boy



Bit

Model	Order No.	α
CBY09010-5P	966.422	90°
CBY09013-5P	966.423	90°
CBY09016-5P	966.424	90°
CBY09022-5P	966.425	90°
CBY12013-5P	800.945	120°

Screw

Locking Screw	Order No.
H0403-5P	978.256
H0504-5P	801.046
H0505-5P	801.047

- Bits are available as 5 piece sets.
- Bit grade is HSS with TiN coating.

Recommended Cutting Condition

C.2

Workpiece Material	Cutter Type	Chamfering		Centering	
		Vc (m/min)	f (mm/rev)	Vc (m/min)	f (mm/rev)
General Steel Alloy Steel	Standard	20 - 35	0.10	25 - 50	0.08
	long	20 - 35	0.08	20 - 50	0.08
Stainless Steel	Standard	15 - 30	0.08	20 - 40	0.08
	long	15 - 30	0.06	15 - 30	0.06
Cast Iron	Standard	20 - 40	0.12	30 - 45	0.10
	long	20 - 40	0.10	30 - 45	0.10
Aluminium	Standard	45 - 60	0.15	50 - 65	0.15
	long	40 - 60	0.12	40 - 60	0.12

- The table is just a reference to determine cutting conditions. It should be adjusted according to the condition of the machine tool and workpiece.
- In case vibration occurs, reduce cutting speed V.
- Projection length should be as short as possible. Vc: Cutting speed (m/min.) f: Feed per revolution (mm/rev.)

C-Cutter Boy

For bench drill machine only. Smooth guide with carbide support pad. Never get irregular chamfering. Long tool life with carbide insert. Economical with its 3 cutting edges.

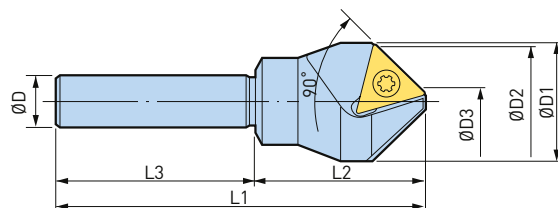

Model	Order No.	ØD	ØD1	ØD2	ØD3	L1	L2	L3	Insert Type
ST12B-C0525	966.408	12	27	25	5	83	38	45	C1603B

1. Including 1 pce. of insert.
2. ØD2 and ØD3 indicate the min. and max. bore diameter.

Indexable Insert for C-Cutter Boy

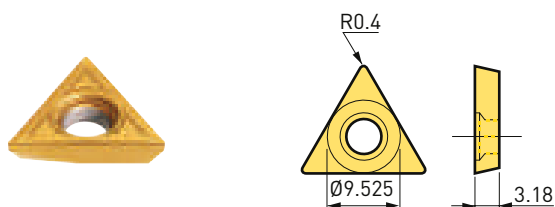

Model	Order No.
C1603B	966.409

1. Inserts are available in a packet of 10 pcs.

C-Cutter Boy - Guide Pad Set



Model	Order No.	Thread size	Carbide guide
CG0525S	978.908	M4x7	CG0525

1. The set contains 1pce of Carbide Guide and 1pce screw.

Insert Clamping Screw Set

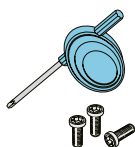

Set Model	Order No.	Thread Size
S4S	806.148	M4 x 8

1. 10 pce. of clamping screw and 1 pce. of wrench are included.

Recommended Cutting Condition

Hole Dia. Ø	Spindle Speed (min ⁻¹)		
	Steel	Cast Iron	Aluminium
5	600	800	1000
10	500	600	800
15	400	500	600
20	300	400	500

BF-Cutter

Selected spot facing diameters suitable for cap screws.

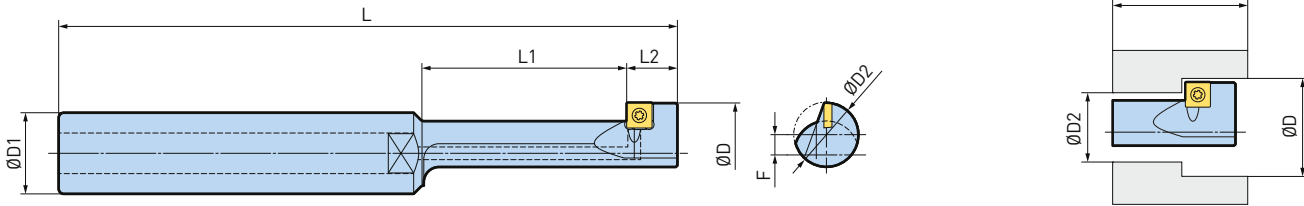
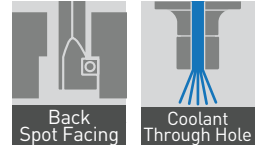

Model	Order No.	ØD	ØD1	ØD2	L	L1	L2	F	Insert Type
ST16-BFM6/11-12	802.752	11	16	6.5	102	12	9	2.4	CM0502
ST16-BFM8/14-20	802.753	14	16	8.5	108	20	9	2.9	CM0502
ST16-BFM10/17.5-25	802.750	17.5	16	10.5	112	25	10	3.65	CM0502
ST16-BFM12/20-36	802.751	20	16	13	122	36	10	3.65	CM0502
ST20-BFM14/23-49	802.754	23	20	15	136	49	10	4.15	CM0502
ST20-BFM16/26-56	802.755	26	20	17	142	56	10	4.65	CM0502

1. Wrench and screws are included.
2. Inserts are to be ordered separately.
3. Insert clamping set contains 10 pcs screw and 1 pcs wrench.

Indexable Inserts for BF-Cutter

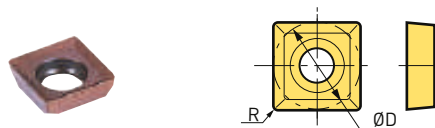

Model	ØD	Nose R	P	M	N
			ACP200	ACM250F	DS20
CM0502	Ø5	0.2	966.441	807.187	966.442

1. Insert clamping set contains 10 pcs screw and 1 pcs wrench.

Spare Parts

Cutting Type	Insert Clamping Screw Set	Order No.
BFM6/11	S2SS-T6	966.448
BFM8/14		
BFM10/17.5		
BFM12/20	S2TS-T6	966.449
BFM14/23		
BFM16/26		

C.2

Recommended Cutting Condition

Workpiece Material	Insert Grade	Cutting Speed (m/min)	Feed Rate (mm/rev)
General Steel, High-Alloy Steel	ACP200	30	0.03
Cast Iron		30	0.03
Aluminium, Non-Ferrous	DS20	30 - 50	0.03

Insert grade

ACP200	ACM250F	DS20
General steel	Stainless Steel	Aluminium & non-ferrous
High wear-resistant PVD coating on carbide substrate with ultra multilayer TiAlN and AlCrN in micron order.	PDV-coated carbide with excellent smoothness and resistance to welding and chapping, due to the AlTiN and TiAlCrN.	Ultra smooth and low friction DLC coating on carbide substrate having excellent anti-adhesive property.

Chamfer Rings for Boring Heads

Chamfering rings for single- and rough-cutter boring bars for 30° or 45° chamfering immediately after boring without tool change.

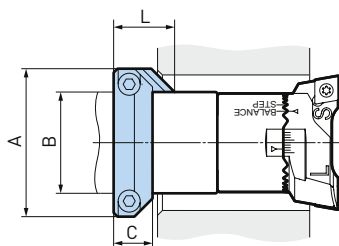

Fig. 1

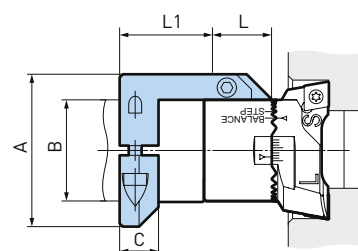

Fig. 2

Model	Order No.	Body	Fig.	ØD	L1	A	B	C	Insert Type
CR20	663.110	CK1	1	20 - 35	-	35	19	13	CRP 20-45, CRP 20-30
CR25	663.120	CK2	1	25 - 40	-	42	24	15	CRP 20-45, CRP 20-30
CR25S	663.121	CK2	2	25 - 40	27	42	24	15	CRP 20-45, CRP 20-30
CR32	663.130	CK3	1	32 - 47	-	49	31	15	CRP 20-45, CRP 20-30
CR32S	663.131	CK3	2	32 - 47	31.5	51	31	15	CRP 20-45, CRP 20-30
CR41	663.140	CK4	1	41 - 55	-	57	39	15	CRP 20-45, CRP 20-30
CR41S	663.141	CK4	2	41 - 55	38.5	57	39	15	CRP 20-45, CRP 20-30
CR53	663.150	CK5	1	53 - 90	-	85	50	25	CRP 53-45, CRP 53-30
CR53S	663.151	CK5	2	53 - 90	39	90	50	25	CRP 53-45, CRP 53-30
CR68	663.160	CK6	1	68 - 104	-	100	64	25	CRP 53-45, CRP 53-30
CR68S	663.161	CK6	2	68 - 104	53	104	64	25	CRP 53-45, CRP 53-30
CR93-125	663.170	CK6	1	90 - 130	-	130	64	25	CRP 53-45, CRP 53-30

1. Dimension "L" is defined according to the Insert.

Inserts 45° and 30°

Carbide inserts with ground chip breaker for machining of cast iron and steel.

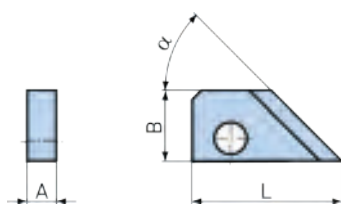

Model	Order No.	ØD	L	A	α	B
CRP20-30	663.181	20 - 55	27.5	4	30°	9
CRP20-45	663.191	20 - 55	23.5	4	45°	9
CRP53-30	663.185	53 - 100	52	8	30°	20
CRP53-45	663.195	53 - 130	43	8	45°	20

Insert Holder for Indexable Type

For different work piece materials and a quick change of the insert.



Fig. 1



Fig. 2

α	Model	Order No.	Fig.	Ring Type	Range Ø	Insert Model
45°	CB2-45CW12A	805.811	1	CR53	55 - 75	CW12
				CR68	69 - 89	
				CR93-125	95 - 115	
	CB2-45CW12B	805.812	2	CR53	70 - 90	
				CR68	84 - 105	
				CR93-125	110 - 130	

1. A wrench and screw are included. Inserts to be ordered separately.
2. For Inserts (CW12) refer to page 551.

Slot Milling Cutter - Cylindrical Shank Type

Slot milling cutter with indexable inserts for circlip grooves as per DIN472.

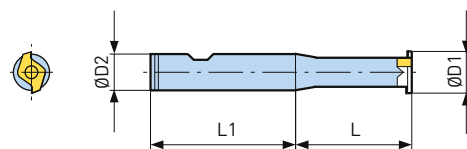

Model	Order No.	ØD	ØD1	ØD2	L	L1	Insert Type
DNF12-22XW10	958.008	12 - 24	11.5	10	32	40	Type 0

Slot Milling Cutter - CK Shank Type

Slot milling cutter with indexable inserts for circlip grooves as per DIN472.

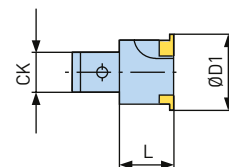

Model	Order No.	ØD	ØD1	L	Connection	Number of Inserts	Insert Type
DNF22-34XCK1	958.010	22 - 34	21	15	CK1	2	Type 1
DNF34-50XCK2	958.021	34 - 50	33	20	CK2	3	Type 1

Slot Milling Cutter - Arbor Type

Slot milling cutter with indexable inserts for circlip grooves as per DIN472.

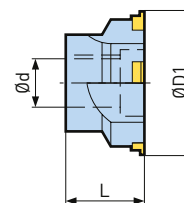
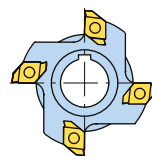

Model	Order No.	ØD	Ød	ØD1	L	Number of Inserts	Insert Type
DNF50-85XF16	958.031	50 - 85	16	48	26	4	Type 1
DNF85-210XF27	958.041	85 - 210	27	83	32	6	Type 2

C.2

Carbide inserts for slot milling as per DIN 472

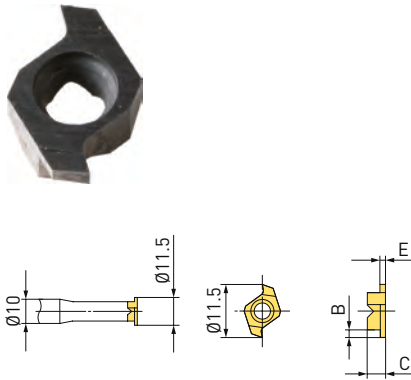

Model	Order No.	E	B	C	Cast Iron	Steel	Aluminium	Insert Type
DN110GGK20	958.052	1.15	0.9	4	++			Type 0
DN110STP20	958.051	1.15	0.9	4				Type 0
DN110ALK20	958.053	1.15	0.9	4			++	Type 0
DN130GGK20	958.056	1.35	1.3	4	++			Type 0
DN130STP20	958.055	1.35	1.3	4				Type 0
DN130ALK20	958.057	1.35	1.3	4			++	Type 0
DN315GGK20	958.092	3.2	3	6	++			Type 2
DN315STP20	958.091	3.2	3	6				Type 2
DN315ALK20	958.093	3.2	3	6			++	Type 2
DN415GGK20	958.096	4.2	3.5	6	++			Type 2
DN415STP20	958.095	4.2	3.5	6				Type 2
DN415ALK20	958.097	4.2	3.5	6			++	Type 2

1. Inserts are available in pieces.

Carbide inserts for slot milling as per DIN 472

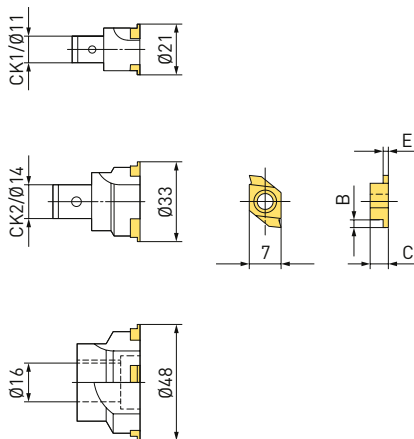

Model	Order No.	E	B	C	Cast Iron	Steel	Aluminium	Insert Type
DN110GGK20	958.062	1.15	1.1	4	++			Type 1
DN110STP20	958.061	1.15	1.1	4				Type 1
DN110ALK20	958.063	1.15	1.1	4			++	Type 1
DN130GGK20	958.066	1.35	1.5	4	++			Type 1
DN130STP20	958.065	1.35	1.5	4				Type 1
DN130ALK20	958.067	1.35	1.5	4			++	Type 1
DN160ALK20	958.073	1.65	1.6	4			++	Type 1
DN160STP20	958.071	1.65	1.6	4				Type 1
DN160GGK20	958.072	1.65	1.6	4	++			Type 1
DN185GGK20	958.076	1.9	2	4	++			Type 1
DN185STP20	958.075	1.9	2	4				Type 1
DN185ALK20	958.077	1.9	2	4			++	Type 1
DN215GGK20	958.082	2.2	2.2	4	++			Type 1
DN215STP20	958.081	2.2	2.2	4				Type 1
DN215ALK20	958.083	2.2	2.2	4			++	Type 1
DN265GGK20	958.086	2.7	2.6	4	++			Type 1
DN265STP20	958.085	2.7	2.6	4				Type 1
DN265ALK20	958.087	2.7	2.6	4			++	Type 1

1. Inserts are available in pieces.

Recommended Cutting Condition

These values relate to the milling cutter circumference and apply under normal working conditions. Climb-cut milling is recommended with helical or tangential plunging to groove depth assuming a continuous program cycle without feed interruption.

Work Piece Material	Cutting Speed Vc [m/min]	Feed per Tooth fz [mm]
Cast Iron	80 - 130	0.12 - 0.25
Steel	120 - 200	0.10 - 0.20
Aluminium	200 - 400	0.15 - 0.30

C.2

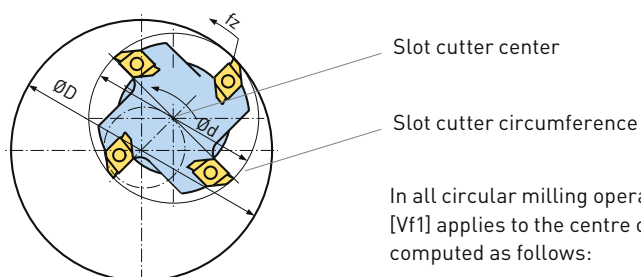

$\varnothing D$ Circular slot diameter
 $\varnothing d$ Slot cutter circumference
 V_f Feed rate at the circumference of the milling cutter
 V_{f1} Feed rate at the center of the milling cutter

In all circular milling operations the programmed feed rate [Vf1] applies to the centre of the milling cutter. This may be computed as follows:

$$V_{f1} = V_f - \frac{\varnothing D - \varnothing d}{\varnothing D}$$

Measuring Instruments

Point Master Series	576
Base Master Series	579
Tool Master / Accu Center	581
Alignment Tool for ATC Arm	582
Dyna Force	583
Dyna Test	584
Dyna Contact	586
Level Master	587
Centering Tool for Lathe	588



Point Master Pro Series - Cylindrical Type

Point Master Pro Series is a precision 3-D touch sensor operating in non-conductive as well as conductive applications, resin, ceramic or coated workpieces, machines with ceramic spindle taper or bearings can all be accommodated.

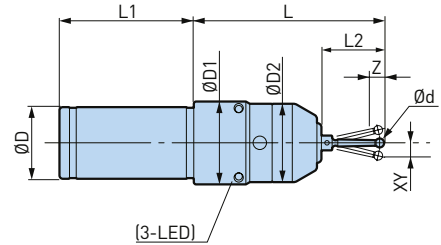

Model	Order No.	Ød	ØD	ØD1	ØD2	L	L1	L2	Over-Travel XY	Over-Travel Z	Measuring Pressure (N) XY	Measuring Pressure (N) Z	Battery	Stylus (included)
PMP-10.	978.976	4	10	35	35	75	49	28	± 12	5	0.4	1.5	BR425	ST28-4R
PMP-20.	961.237	4	20	37	35	90	50	28	± 12	5	0.4	1.5	LR1 x 2	ST28-4R

1. PMP-10 has one LED only.
2. Above table indicates the specification when using stylus ST28-4R.
3. There is approx 5 µm lag in X and Y directions and approx. 2 µm lag in Z direction to illuminate LED lamp when stylus touches workpiece surface.
4. Battery is not included.

Point Master Pro Series - BBT Type

JIS B 6339 (BIG-PLUS®)

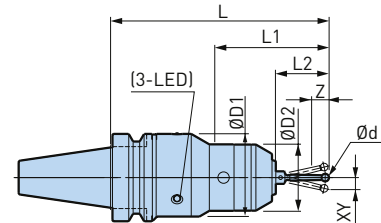

Fig. 1

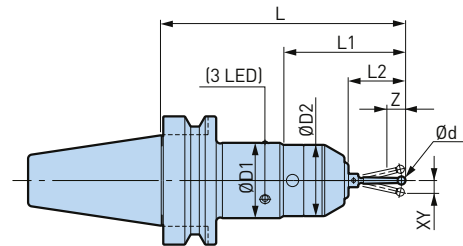

Fig. 2

Model	Order No.	Fig.	Ød	ØD1	ØD2	L	L1	L2	Over-Travel XY	Over-Travel Z	Measuring Pressure (N) XY	Measuring Pressure (N) Z	Battery	Stylus (included)
BBT30-PMP-115.	802.313	1	4	46	35	115	63	28	± 12	5	0.4	1.5	CR2 x 1	ST28-4R
BBT40-PMP-120.	804.649	2	4	37	35	120	60	28	± 12	5	0.4	1.5	LR1 x 2	ST28-4R

1. Above table indicates the specification when using stylus ST28-4R.
2. There is approx 5 µm lag in X and Y directions and approx. 2 µm lag in Z direction to illuminate LED lamp when stylus touches workpiece surface.
3. Battery is not included.

D.1

Point Master Pro Series - HSK Type

Point Master Pro Series is a precision 3-D touch sensor operating in non-conductive as well as conductive applications, resin, ceramic or coated workpieces, machines with ceramic spindle taper or bearings can all be accommodated.

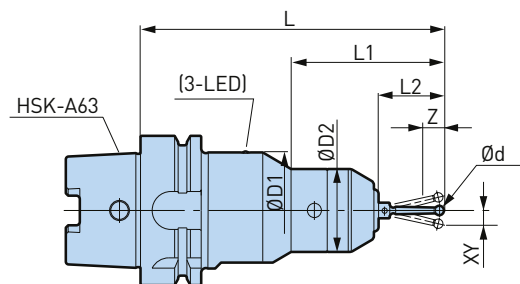

Model	Order No.	Ød	ØD1	ØD2	L	L1	L2	Over-Travel XY	Over-Travel Z	Measuring Pressure (N) XY	Measuring Pressure (N) Z	Battery	Stylus (included)
HSK-A63-PMP-130.	804.656	4	49	35	130	65	28	±12	5	0.4	1.5	CR2 x 1	ST28-4R

- Above table indicates the specification when using stylus ST28-4R.
- There is approx 5 µm lag in X and Y directions and approx. 2 µm lag in Z direction to illuminate LED lamp when stylus touches workpiece surface.
- Battery is not included.

Point Master PMC Series

Point Master PMC series is ideal touch sensor for electric conductive materials. LED lamp illuminates when the stylus touches the workpiece. Stroke of stylus provides sufficient over-travel for safety.

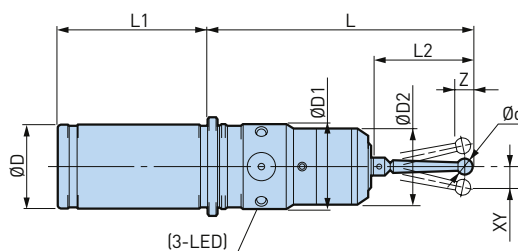
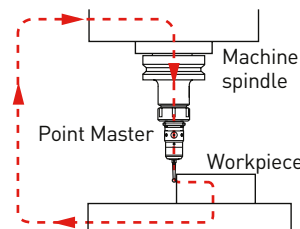

Fig. 1

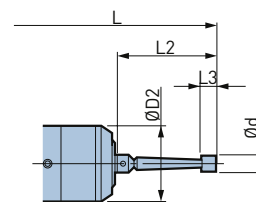

Fig. 2

Model	Order No.	Fig.	Ød	ØD	ØD1	ØD2	L	L1	L2	Over-Travel XY	Over-Travel Z	Measuring Pressure (N) XY	Measuring Pressure (N) Z	Battery	Stylus (included)
PMC-20.	961.238	1	6	20	32	29	110	50	38	± 12	5	0.6	2.7	LR1 x 2	ST38-6P
PMC-20S.	804.658	2	6	20	32	29	110	50	38	± 12	5	0.6	2.7	LR1 x 2	ST 38-6x6

- Measurement is not possible with non-conductive machine or workpiece.
- Battery is not included.

Point Master PMG Series

LED lamp illuminates when the stylus touches the workpiece.

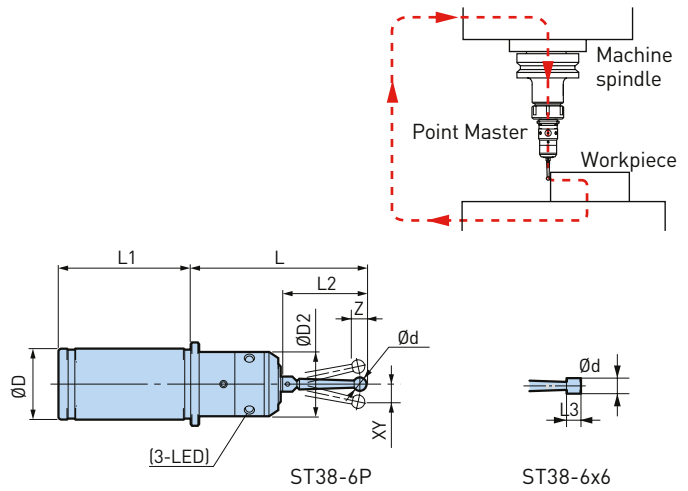

Model	Order No.	Ød	ØD	ØD2	L	L1	L2	L3	Over-Travel XY	Over-Travel Z	Measuring Pressure (N) XY	Measuring Pressure (N) Z	Battery	Stylus (included)
PMG-10.	961.200	6	10	29	75	50	38	6	± 12	5	0.6	2.7	BR435 x 1	ST38-6P
PMG-10S.	804.662	6	10	29	75	50	38	6	± 12	5	0.6	2.7	BR435 x 1	ST38-6x6
PMG-20.	961.205	6	20	29	90	50	38	6	± 12	5	0.6	2.7	LR1 x 2	ST38-6P
PMG-20S.	961.206	6	20	29	90	50	38	6	± 12	5	0.6	2.7	LR1 x 2	ST38-6x6

1. Measurement is not possible with non-conductive machine or workpiece.
2. Battery is not included.

Alternative Stylus

The stylus (M3 thread) is replaceable. Please replace when different model of stylus required or if damaged.

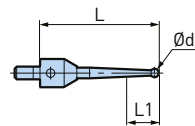

Fig. 1

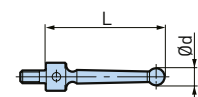

Fig. 2

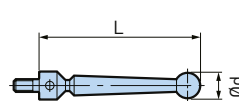

Fig. 3

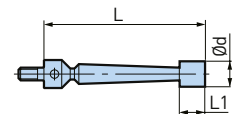

Fig. 4

Model	Order No.	Fig.	Ød	L	L1	Material	Point Master Serie
ST28-1P	802.222	1	1	28	2	Carbide	PMC·PMP·PMG
ST28-2P	802.223	1	2	28	8	Carbide	PMC·PMP·PMG
ST28-3P	972.309	2	3	28	-	Carbide	PMC·PMP·PMG
ST28-4P	972.311	2	4	28	-	Carbide	PMC·PMP·PMG
ST28-4R	972.310	2	4	28	-	Ruby	PMP
ST38-6P	972.304	3	6	38	-	Steel [SUS]	PMC·PMG
ST38-6X6	972.306	4	6	38	6	Steel [SUS]	PMC·PMG

1. Stylus model ST38-6x6 is exclusive for PMC-20S and PMG-20S. Runout accuracy may worsen when used on other models.

Base Master- BM-50H

Base Master Series is a precision touch sensor to determine workpiece offsets and tool length. Mounted on workpiece surface or machine table, LED lamp illuminates immediately when the cutting edge touches the sensor plate and the position is detected.

The most popular Base Master model with 1µm accuracy. Operates when a conductive circuit is completed.

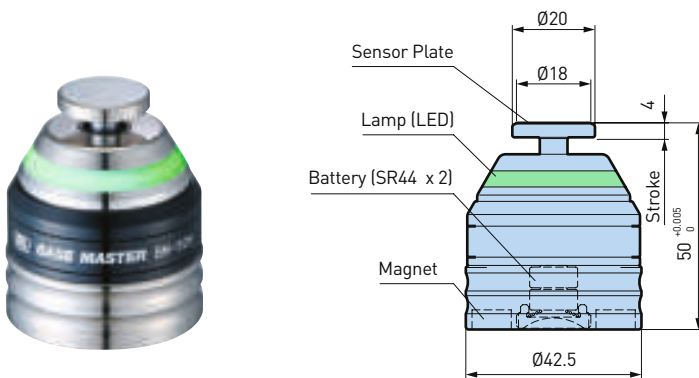

Model	Order No.
BM-50H	807.713

1. Battery is not included.
2. Min. Measurable Cutting Tool Diameter is Ø 1 mm

Base Master- BM-50GH

Suitable for various tools and workpieces, including non-conductive materials such as ceramics.

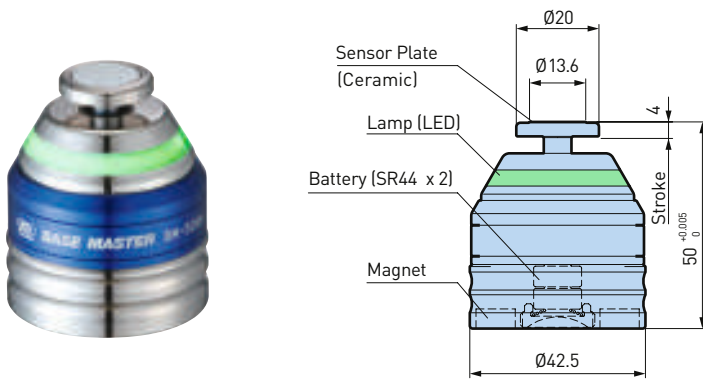

Model	Order No.
BM-50GH	807.714

1. Battery is not included.
2. Min. Measurable Cutting Tool Diameter is Ø 1 mm

Base Master- BM-50MH

Specifically designed for micro cutting tools. Low measuring pressure protects the cutting edge.

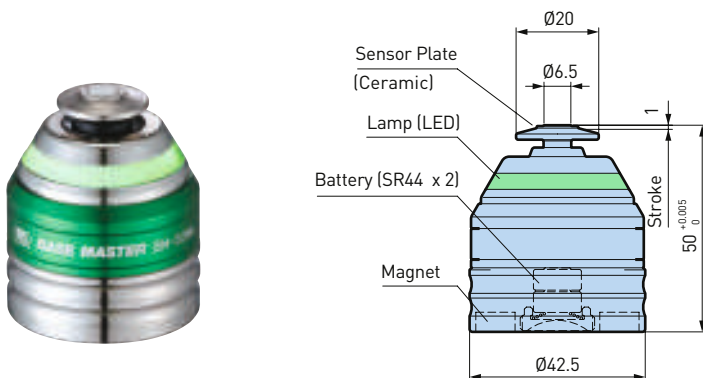

Model	Order No.
BM-50MH	807.715

1. Battery is not included.
2. Min. Measurable Cutting Tool Diameter is Ø 0.05 mm

Base Master Series - Base Master Mini

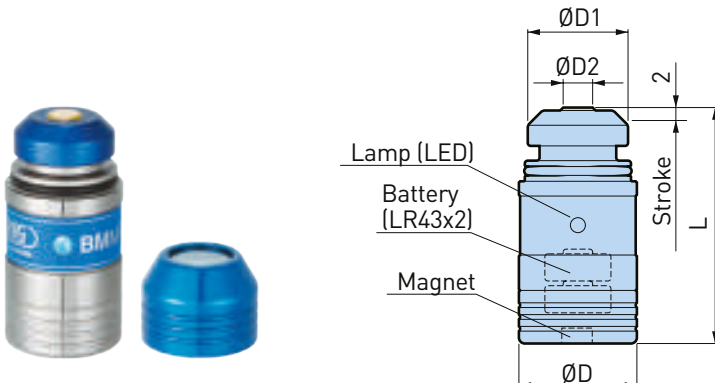

Model	Order No.	Battery
BMM-20D	807.718	LR43 x 2

1. Battery is not included.

Base Master Mini for Swiss Lathe Machines

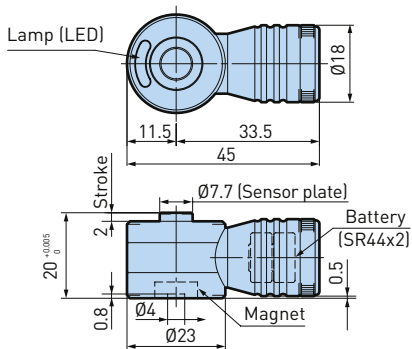
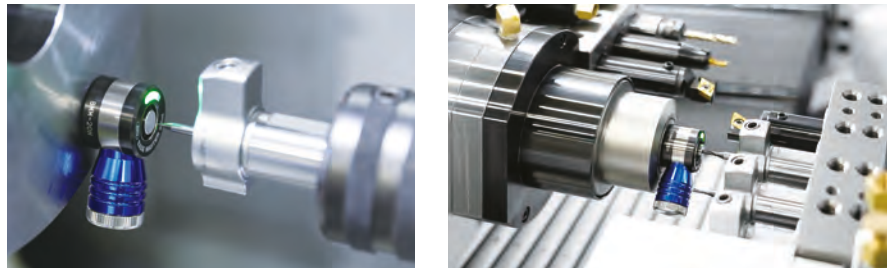

Model	Order No.	Battery
BMM-20H	807.711	SR44 x 2

1. Battery is not included.

D.1

Tool Master

Tool Master is a precision touch sensor with a large dial gauge.

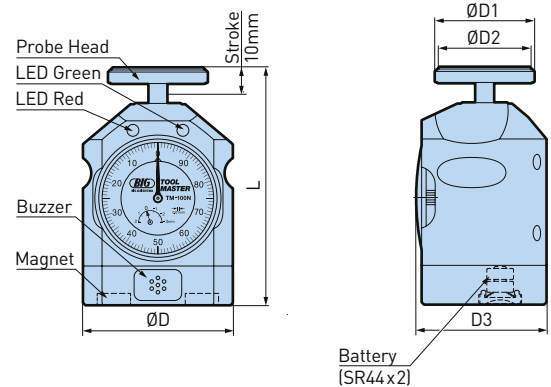

Model	Order No.	ØD	ØD1	ØD2	ØD3	L	Battery
TM-100N.	961.347N	63	42	39	54.8	92 - 102	SR44 x 2

1. Battery is not included.

Accu Center

Accu Center is a simple and precise edge finder offering repeatability within 3 µm. Hard chrome plated stylus offers extended life.

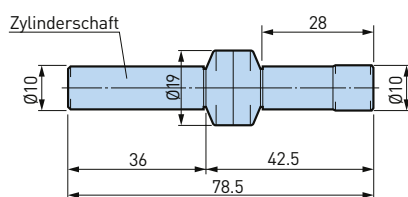
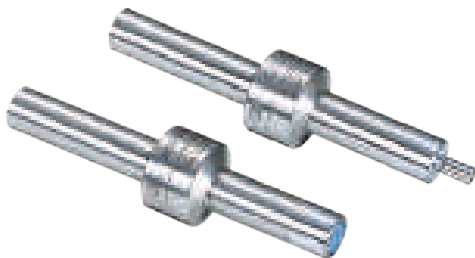

Fig. 1

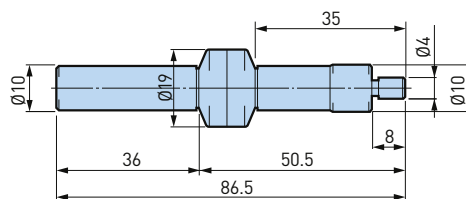

Fig. 2

Model	Order No.	Fig.
ACCU-C10	800.483	1
ACCU-C104	800.484	2

Batteries

Model	Order No.	Accessories for
ETLBAT-LR1	961.207	Point Master Series
ETLBAT-CR2	805.543	Point Master Series
ETLBAT-LR43	961.214	Base Master Series
ETLBAT-435	961.210	Point Master Series
ETLBAT-SR44-1.55V	961.202	Point Master Series, Base Master Series
ETLBAT-BR425-3V	807.165	Lathe Master Series

Alignment Tool for ATC arm

For maintenance of machine tool spindles. Equipment to measure misalignment between the ATC arm and machine tool spindle or magazine pot center.

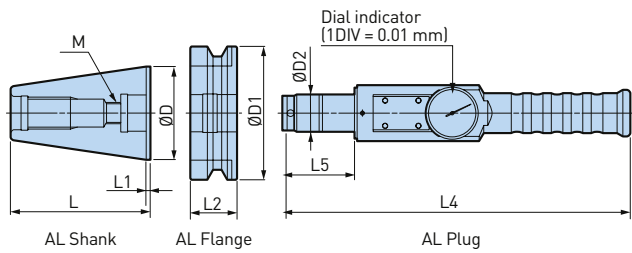

Fig. 1

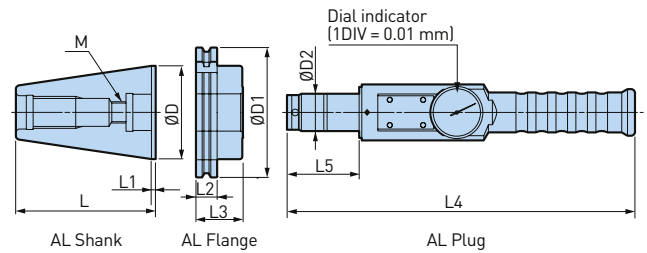

Fig. 2

Model	Order No.	Fig.	ØD	ØD1	ØD2	L	L1	L2	L3	L4	L5	M
BT30-ATC18	978.238	1	31.75	46	18	50.4	2	20	-	251	44	12
BT40-ATC20	978.237	1	44.45	63	20	67.4	2	25	-	251	44	12
BT50-ATC28	978.236	1	69.85	100	28	104.8	3	35	-	261	54	16
DV40-ATC20	801.042	2	44.45	63.55	20	71.6	3.2	15.9	24.3	251	44	12
DV50-ATC28	801.043	2	69.85	97.5	28	104.95	3.2	15.9	35.3	261	54	16

1. For HSK is also available upon request. Please contact BIG KAISER agent.



Exclusive storage case

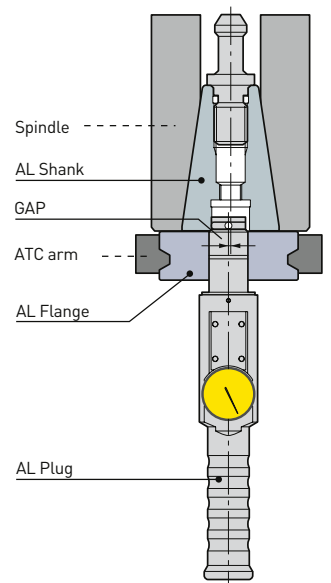

Dyna Force

Measuring device for pulling force of machine tool spindle.



Measuring device

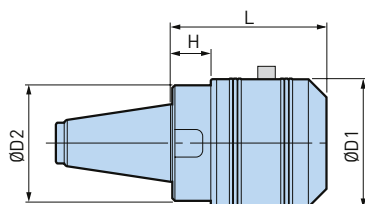

Fig. 1

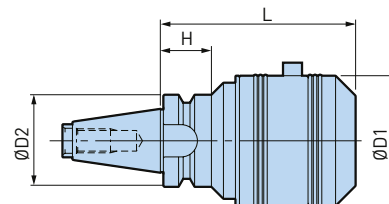
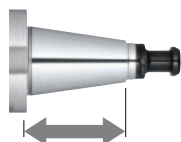

Fig. 2

Longer taper shank to enhance reliability

Long taper supports itself in long span and stabilizes the value of measurement.



Only one display for all taper sizes

One common display can be used for all taper sizes.

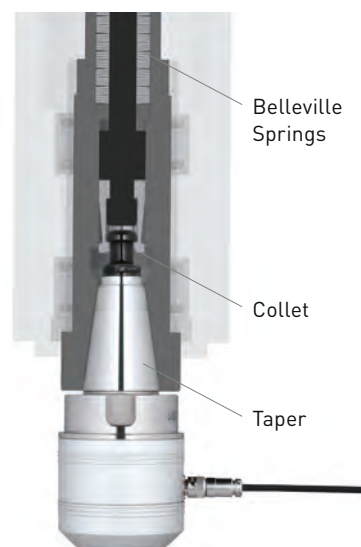
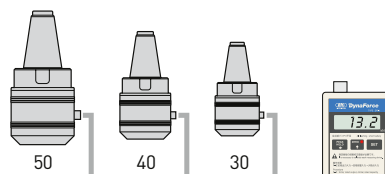

Model	Order No.	Fig.	ØD1	ØD2	L	H	Taper Size
SNT30-DF10	805.845	1	65	58	80	20	ISO 30
SBT30-DF10	805.442	2	65	46	98	26	ISO 30
SNT40-DF30	804.949	1	73	66	90	24	ISO 40
SNT50-DF30	805.846	1	73	70	86	20	ISO 50
SNT50-DF50	805.423	1	96	90	110	33	ISO 50

1. Each component is also available separately. Please contact BIG KAISER agent if individual component is required.
2. Pull stud bolt is to be ordered separately. For DIN, ISO, ANSI & CAT standard machines, exclusive pull stud bolt for dyna force is required.
3. Display DFA-1 uses 2 x AA Battery & Std. cable DFC-1 (2m).

Display



Cable



Case



Exclusive Pullstud Bolts for Dyna Force

An exclusive pullstud bolt is needed for a machine spindle in DIN, ANSI or CAT standard. Pullstud bolts in MAS and JIS standards can be used. These pullstud bolts are not suitable for the SBT30-DF10.

Model	Order No.	Connection	Taper Size
DF-PDV30	804.683	DIN 69872	ISO 30
DF-PAV30	804.680	ANSI B5.50	ISO 30
DF-PCV30	804.684	ASME B5.50	ISO 30
DF-PDV40A	804.685	DIN 69872;ISO 7388 Typ A	ISO 40
DF-PAV40	804.681	ISO 7388 Typ B;ANSI B5.50	ISO 40
DF-PCV40	804.687	ASME B5.50	ISO 40
DF-PDV50A	804.686	DIN 69872;ISO 7388 Typ A	ISO 50
DF-PAV50	804.682	ISO 7388 Typ B;ANSI B5.50	ISO 50
DF-PCV50	804.688	ASME B5.50	ISO 50

Dyna Test BIG-PLUS BT Type

Periodic inspection of the machine spindle to control production stability. Shorter models are ideal for measuring ATC repeatability.

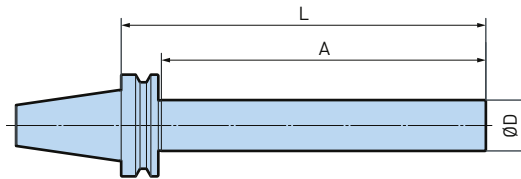

Model	Order No.	ØD	L	A
BBT30-32-L150	800.054	32	150	125
BBT30-32-L235	961.264	32	235	210
BBT40-50-L200	800.065	50	200	170
BBT40-50-L350	978.119	50	350	320
BBT50-50-L200	800.184	50	200	159
BBT50-50-L360	978.290	50	360	319

1. BIG-PLUS® tools can be used in machining centers with non BIG-PLUS® spindles.
2. Taper length is in accordance with JIS BT standard.

Dyna Test BIG-PLUS DV Type

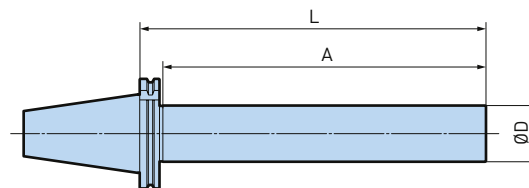

Model	Order No.	ØD	L	A
BDV40-50-L200SD	802.835	50	200	170
BDV40-50-L340SD	802.834	50	340	310
BDV50-50-L200SD	802.833	50	200	178
BDV50-50-L340SD	961.269	50	340	318

1. BIG-PLUS® tools can be used in machining centers with non BIG-PLUS® spindles.
2. The drive key slot are symmetrical to allow BDV dyna test bar to be indexed 180 degrees.

Dyna Test Basic Type

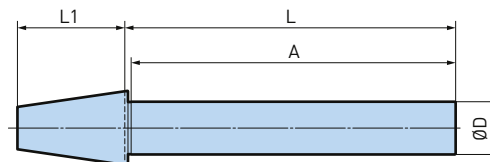

Model	Order No.	ØD	L	L1	A
NT30-32-L150	801.759	32	150	48.4	142
NT30-32-L225	978.253	32	225	48.4	217
NT40-50-L200	801.760	50	200	65.4	184
NT40-50-L335	801.761	50	335	65.4	319
NT50-50-L200	801.762	50	200	101.8	191
NT50-50-L335	801.763	50	335	101.8	326

1. For use on DV spindle, please use DF-PDV Pull Stud Bolt.

D.1

Dyna Test HSK

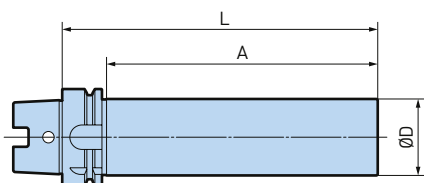
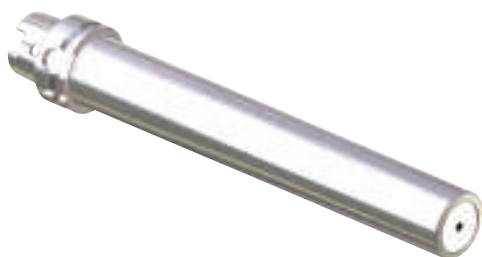

Dyna Test HSK-A Type

Model	Order No.	ØD	L	A
HSK-A40-32-L180SD	801.169	32	180	157
HSK-A50-32-L240SD	978.198	32	240	211
HSK-A63-50-L200SD	801.180	50	200	171
HSK-A63-50-L350SD	978.222	50	350	321
HSK-A100-50-L200SD	801.072	50	200	168
HSK-A100-50-L350SD	801.073	50	350	318

1. The drive key slots are symmetrical to allow the HSK form A dyna test bar to be indexed 180 degrees.
2. DIN 69893-1 & ISO 12164-1

Dyna Test HSK-E Type

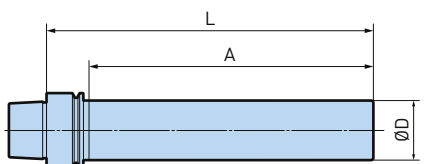

Model	Order No.	ØD	L	A
HSK-E25-20-L175	978.307	20	175	163
HSK-E32-20-L180	802.831	20	180	158
HSK-E40-32-L180	978.178	32	180	157
HSK-E50-32-L240	979.140	32	240	211

1. DIN 69893-5

Dyna Test HSK-F Type

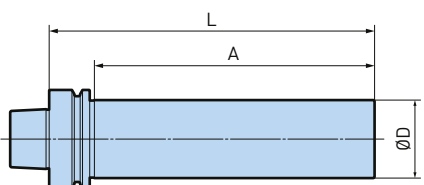

Model	Order No.	ØD	L	A
HSK-F63-50-L200	802.830	50	200	171
HSK-F63-50-L350	802.832	50	350	321

1. DIN V 69893-6

Dyna Test BIG CAPTO Type

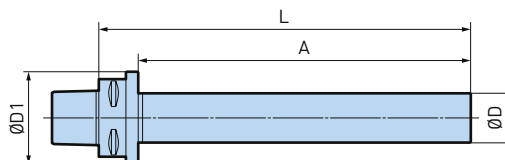
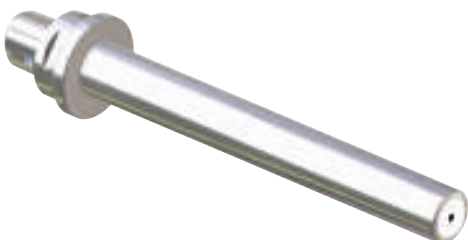

Model	Order No.	ØD	ØD1	L	A
C5-40-L250	800.045	40	63	280	250
C6-40-L200	973.737	40	75	232	200
C6-40-L320	973.738	40	75	352	320
C8-40-L200	973.739	40	75	240	197
C8-40-L320	973.740	40	85	360	320

Dyna Contact

A ceramic taper gauge allowing inspection of machine spindle tapers at a glance.

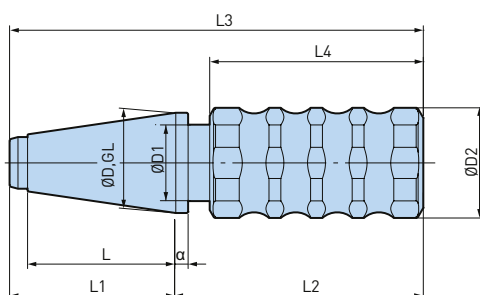

Supplied in Aluminium Case

Model	Order No.	ØD	ØD1	ØD2	L	L1	L2	L3	L4	α	Taper Size
DC-30P	806.806	31.75	23	36	48.4	56.4	106.6	163	93.6	6	30
DC-40P	806.807	44.45	34	36	65.4	73.4	110.6	184	95	6	40
DC-50P	806.808	69.85	49	49	101.8	111.8	113.2	225	95	8	50

1. It can be used for BBT (BT=JISB 6339), BDV (DV=DIN 69871) and BCV (CV = ANSI)

Level Master

2-axis simultaneous detection leveler. LED displays level conditions for both axis simultaneously. LED and buzzer indication when leveling is completed.



Standard Type



Wireless Type



Body

Receiver

Model	Order No.
LVM-01	801.673

Model	Order No.
LVM-WL.	806.805

1. Body and receiver are available only as a set.
2. Battery [LR03] is not included.
3. In the case of high precision leveling, we recommend to check the Level Master in advance on a reference level, such as a level block.

Remote Work solution Wireless Type

Easy and quick leveling with a single operator.

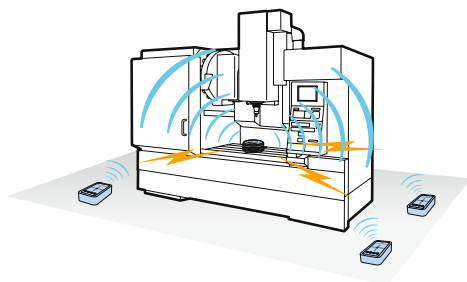

Supplied in Aluminium Case



Simultaneous 2-axis detection

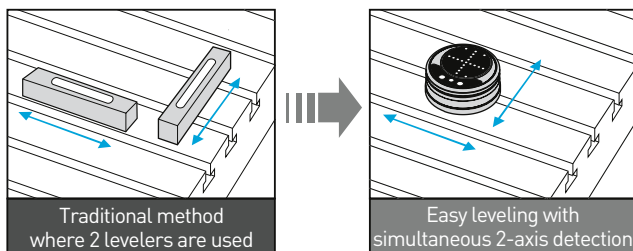

LED & buzzer indicate leveling completion

High Mode

when the required level condition is within 0.01 mm / 1 m

Low Mode

when the required level condition is within 0.1 mm / 1 m

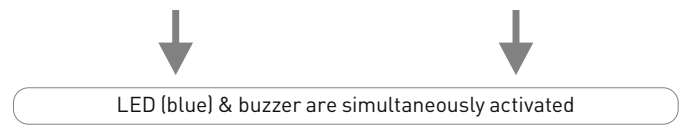

Centering Tool for Lathes

Easy Centering with Static Dial Gauge

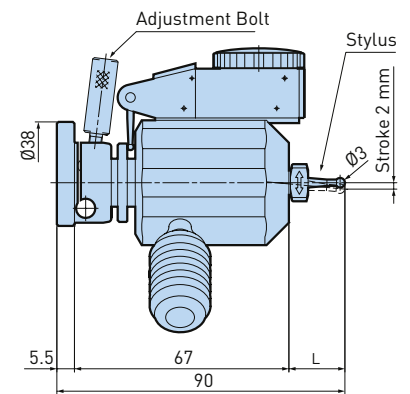
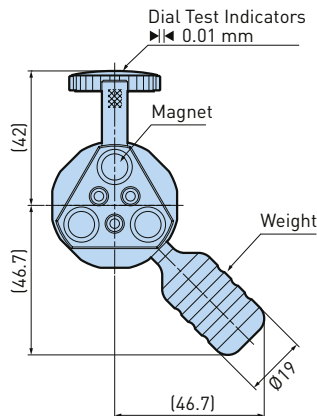

Model	Order No.	Min. Scale	max. min-1	Stylus (included)
CTL-90	806.436	0.01 mm	50	ST3-CT90

1. Stylus ST3-CT90 is included.

Stylus for CTL-90

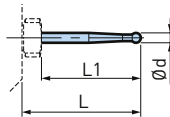

Model	Order No.	Ød	L	L1	Material
ST3-CT90	806.437	3	17.5	11.5	Ruby
ST3-CT90L	806.912	3	37.5	31.5	Ruby

Lathe Master

Tool setting without measuring cut.

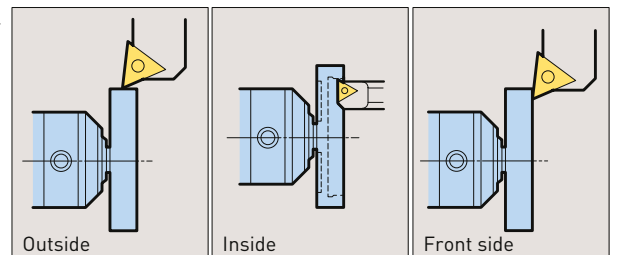
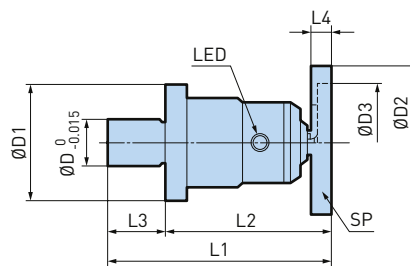

Model	Order No.	ØD	ØD1	ØD2	ØD3	L1	L2	L3	L4	Repeatable Accuracy	Battery
LM-15	806.997	15	40	50	40	75	55	20 ±0.02	8	±2µ	BR425 x 1
LM-30	805.397	30	40	50	40	65	45	20 ±0.02	8	±2µ	SR44 x 2

1. Machines and tools must be electrically conductive.
2. Clamp the shank (ØD) of the Lathe Master in the collet chuck of the lathe. The LED lights up as soon as the tip of the tool touches the sensor plate.
3. Battery is not included.



Special pen type BR-425 for LM-15



2 x SR-44 Battery for LM-30

List with Order Numbers and Weights

Order No.	Weight (kg)	Page	Order No.	Weight (kg)	Page	Order No.	Weight (kg)	Page	Order No.	Weight (kg)	Page	Order No.	Weight (kg)	Page
100019.001.0	0.440	103	101126.003.0	3.400	308	310.401	0.400	439	319.350	0.001	500	323.861N	4.450	142
100019.002.0	0.440	103	101126.004.0	4.100	308	310.405A	0.410	446	319.401	0.360	383	323.862	7.000	142
100019.003.0	0.440	103	101127.001.0	1.900	297	310.501	0.820	439	319.450	0.001	500	323.864N	4.920	142
100042.001.0	8.800	385	101127.002.0	2.300	297	310.505A	0.810	446	319.501	0.660	383	323.865N	7.000	142
100042.002.0	16.400	385	101127.003.0	3.300	297	310.601	1.650	439	319.550	0.002	500	323.866N	13.200	142
100042.003.0	9.300	385	101127.004.0	4.000	297	310.602	2.400	439	319.601	1.180	383	323.868	3.250	142
100042.004.0	16.900	385	101128.001.0	1.200	297	310.605A	1.700	446	319.601N	1.180	383	323.871N	4.900	92
100108.002.0	2.700	184	101128.002.0	1.800	297	310.606A	1.730	446	319.602	1.900	383	323.874N	3.950	92
100108.003.0	2.700	184	101129.001.0	1.300	308	310.607A	1.250	446	319.602N	1.900	383	323.875	7.370	92
100108.004.0	2.800	184	101129.002.0	1.900	308	310.608A	1.750	446	319.603	2.520	383	324.111F	0.220	222
100108.005.0	2.800	184	112.097A	2.150	417	310.701	3.850	439	319.603N	2.520	383	324.112F	0.220	191
100108.006.0	2.900	184	112.097C	2.150	417	310.705A	1.700	446	319.604N	0.550	384	324.121F	0.200	222
100132.007.0	0.360	220	112.107	1.370	399	310.706A	1.830	446	319.605N	0.850	384	324.131F	0.260	222
100132.008.0	0.360	220	112.108	1.100	399	310.708	5.360	439	319.607N	1.300	384	324.132F	0.260	191
100182.001.0	0.030	433	112.110	1.300	398	310.820	0.110	437	319.650	0.005	500	324.141F	0.360	222
100237.001.0	0.570	351	112.121	1.770	399	310.840	0.330	437	319.701	3.100	383	324.142F	0.340	191
100237.002.0	0.570	351	112.122	1.890	399	310.850	0.780	437	319.701N	3.100	383	324.231F	0.460	222
100570.001.0	0.100	314	112.123	1.710	399	310.860	1.650	437	319.702	4.500	383	324.232F	0.440	191
100644.001.0	0.720	518	112.126A	1.700	398	310.865	2.430	437	319.702N	4.500	383	324.241F	0.520	222
100644.002.0	0.830	518	112.205	0.260	419	310.870	3.950	437	319.703	5.600	383	324.242F	0.500	191
100650.001.0	1.100	524	112.206	0.260	419	315.751	0.024	500	319.703N	5.600	383	324.251F	0.710	222
100650.002.0	1.200	524	112.207	0.310	419	317.193	0.001	509	319.705N	1.600	384	324.252F	0.660	191
100650.003.0	1.300	524	112.271	0.025	504	317.285	0.850	460	319.706N	1.920	384	324.312F	0.730	191
100650.004.0	1.100	524	112.272	0.035	504	318.101	0.820	444	319.707N	2.300	384	324.322F	0.830	191
100650.005.0	1.200	524	112.301A	0.540	419	318.104	0.800	457	319.750	0.005	500	324.331	0.850	191
100650.006.0	1.400	524	112.303A	0.880	419	318.105	0.840	457	321.451	1.000	262	324.331F	0.850	191
100650.007.0	1.100	524	112.304A	0.540	419	318.107	0.830	457	321.462	1.090	262	324.332	1.120	191
100650.008.0	1.200	524	112.306	0.670	418	318.201	2.750	456	322.563	1.800	262	324.341	1.150	191
100650.009.0	1.400	524	112.310	0.400	418	318.201N	2.800	456	323.563	2.060	262	324.341F	1.150	191
100650.010.0	1.200	524	112.353	0.048	504	318.202	2.730	456	323.701	0.380	144	324.342	1.300	191
100650.011.0	1.400	524	112.371	0.010	504	318.202N	2.730	456	323.703	0.350	145	324.352	0.960	191
100650.012.0	1.600	524	112.381	0.001	500	318.205	1.830	456	323.705	0.390	95	324.352F	0.960	191
100650.013.0	1.400	524	112.385	0.096	504	318.205N	1.830	456	323.707	0.350	95	324.353	1.320	191
100650.014.0	1.600	524	112.503	0.030	433	318.206	2.320	456	323.721	1.130	145	324.354	1.940	191
100650.015.0	2.000	524	112.504	0.030	433	318.206N	2.320	456	323.722	2.060	144	324.361	1.250	191
100650.016.0	1.500	524	112.505	0.130	430	318.222	1.500	456	323.726N	1.120	144	324.361F	1.250	191
100650.017.0	2.000	524	112.506	0.150	430	318.223	2.040	456	323.728	0.820	144	324.361N	1.250	191
100650.018.0	2.400	524	112.507	0.050	431	318.224	2.620	456	323.730	1.200	95	324.362	1.820	191
100654.001.0	0.750	531	112.508	0.030	433	318.225	3.210	456	323.731	1.320	95	324.367N	3.230	191
100654.002.0	0.850	531	112.804	0.016	504	318.226	3.900	456	323.735N	1.300	95	324.461	1.950	191
100763.001.0	0.006	503	112.806	0.160	414	318.227	4.400	456	323.736N	1.300	95	324.531	2.450	192
100911.001.0	0.370	319	112.837	2.570	417	318.240	1.100	456	323.738	0.960	95	324.541	2.870	192
100911.002.0	0.370	319	112.837A	2.570	417	318.261	1.210	460	323.760	3.400	145	324.551	2.900	192
100911.003.0	0.340	319	112.837B	2.570	417	318.421	14.660	463	323.761	4.600	145	324.552	3.770	192
100911.004.0	0.310	319	112.837C	2.570	417	318.422	21.450	463	323.765N	3.450	144	324.561	2.900	192
100911.005.0	0.280	319	112.837E	2.570	417	318.423	33.000	463	323.766N	4.750	144	324.561N	2.800	192
100911.006.0	0.240	319	188.133	0.190	432	318.424	55.000	463	323.767N	4.850	144	324.563	3.450	192
100911.007.0	0.360	319	188.134	0.190	432	318.425	90.000	463	323.768N	7.200	144	324.563N	3.350	192
100911.008.0	0.360	319	195.001	0.001	500	318.431	2.110	463	323.769N	13.700	144	324.566N	6.000	192
100911.009.0	0.340	319	195.003	0.001	500	318.432	2.900	463	323.770	4.000	95	324.571	4.050	192
100911.010.0	0.300	319	195.007	0.001	500	318.433	3.000	463	323.771	5.000	95	324.571N	4.100	192
100911.011.0	0.270	319	309.201	0.120	447	318.434	3.400	463	323.775N	3.900	95	324.572	5.800	192
100911.012.0	0.240	319	309.301	0.220	447	318.435	4.000	463	323.776N	4.950	95	324.572N	5.750	192
101017.001.0	0.030	217	309.401	0.400	447	318.441	1.280	463	323.777	5.400	95	324.575N	11.930	192
101017.002.0	0.035	217	309.501	0.850	447	318.442	1.500	463	323.780	3.000	262	325.933	3.750	144
101017.003.0	0.038	217	309.601	1.850	447	318.443	1.500	463	323.781	3.850	262	325.942	3.650	144
101123.001.0	6.800	205	310.020	0.030	448	318.444	1.500	463	323.821N	1.100	142	325.944	4.250	144
101123.002.0	6.800	205	310.030	0.050	448	319.101	0.050	383	323.825	0.920	142	325.952	3.800	144
101124.001.0	6.300	112	310.101	0.080	439	319.150	0.001	500	323.826	1.150	142	325.954	4.700	144
101124.002.0	13.800	112	310.201	0.130	439	319.201	0.110	383	323.831N	1.300	91	325.955	4.550	144
101126.001.0	2.000	308	310.301	0.210	439	319.250	0.005	500	323.832N	0.990	91	325.964	4.700	145
101126.002.0	2.400	308	310.305A	0.220	446	319.301	0.190	383	323.860N	3.350	142	325.965	5.500	144

Both 6-digit and 10-digit are official order No.

List with Order Numbers and Weights

Order No.	Weight (kg)	Page	Order No.	Weight (kg)	Page	Order No.	Weight (kg)	Page	Order No.	Weight (kg)	Page	Order No.	Weight (kg)	Page
326.005	0.600	145	328.375	2.200	246	332.632	1.200	252	335.323	0.860	449	336.174	0.690	548
326.011	1.200	144	328.376	2.200	246	332.641	0.820	252	335.324	1.100	449	336.175	0.840	548
326.021	1.200	144	328.378	5.100	305	332.642	1.450	252	335.325	1.750	449	336.301	1.160	549
326.031	1.300	144	328.379	5.100	305	332.645	1.050	252	335.326	1.810	449	336.302	1.070	549
326.041	1.300	144	328.380	3.300	304	332.651	0.840	252	335.327	3.650	449	336.303	3.330	549
326.050	0.920	145	328.419	2.400	246	332.652	1.950	252	335.328	3.690	449	336.304	3.850	549
326.054	2.550	144	328.420	3.100	246	332.655	1.230	252	335.329	5.400	449	336.309	1.200	549
326.057	1.100	144	328.421	3.300	246	332.741	1.500	252	335.330	7.150	449	336.310	2.900	549
326.064	2.750	144	328.422	3.900	246	332.745	1.730	252	335.331	2.500	449	336.569	3.300	547
326.141	1.180	95	329.866	0.480	95	332.750	2.460	252	335.380	0.570	449	336.631	0.930	547
326.153	1.850	95	331.110	0.050	253	332.751	1.650	252	335.381	0.810	449	336.632	0.920	547
326.160	0.990	95	331.111	0.070	253	332.755	2.010	252	335.382	1.000	449	336.633	1.000	547
326.163	2.200	95	331.220	0.100	253	332.765	2.250	252	335.383	0.700	449	336.634	0.980	547
328.032N	3.100	243	331.221	0.150	253	332.765N	2.250	252	335.384	0.970	449	336.635	0.960	547
328.033N	1.350	243	331.330	0.160	253	332.766	2.900	252	335.385	1.300	449	336.636	1.030	547
328.034	0.970	243	331.331	0.250	253	332.870N	1.110	254	335.386	1.050	449	336.637	1.150	547
328.035	0.940	243	331.440	0.350	253	332.875N	1.660	254	335.387	1.530	449	336.638	1.140	547
328.036	0.880	243	331.445	0.470	253	335.021	0.080	551	335.388	2.050	449	336.639	1.160	547
328.037	0.780	243	331.550	0.850	253	335.022	0.260	551	335.389	1.230	449	336.640	1.160	547
328.037N	0.850	243	331.555	1.210	253	335.023	0.710	551	335.390	1.770	449	336.641	1.190	547
328.053N	2.420	243	331.660	1.360	253	335.024	2.680	551	335.391	2.400	449	336.642	1.220	547
328.086	3.700	456	331.660N	1.360	253	335.042	1.350	258	335.420	0.260	257	336.643	1.330	547
328.151F	0.220	222	331.665	2.200	253	335.044	1.520	258	335.421	0.350	257	336.644	1.350	547
328.162	3.800	456	331.665N	2.200	253	335.066	1.240	258	335.423	0.420	257	336.645	1.400	547
328.210	3.800	456	331.775	4.400	253	335.070	0.080	560	335.424	0.510	257	336.647	1.460	547
328.211	3.740	456	331.775N	4.400	253	335.071	0.180	560	335.425	0.640	257	336.649	1.590	547
328.213	7.500	465	331.776	7.250	253	335.072	0.310	560	335.430	0.700	257	336.651	1.750	547
328.214	7.500	465	331.776N	7.250	253	335.073	0.280	560	335.430N	0.700	257	336.653	1.770	547
328.215	7.500	465	331.860N	0.550	254	335.074	0.450	560	335.431	0.770	257	336.655	2.150	547
328.216	2.600	465	331.861N	0.800	254	335.077	3.860	258	335.431N	0.770	257	336.657	2.000	547
328.217N	4.740	465	331.864N	0.450	254	335.130	0.130	259	335.432	0.930	257	336.659	2.090	547
328.218F	0.400	222	331.865N	0.950	254	335.131	0.230	259	335.433	1.300	257	336.661	2.270	547
328.223	0.590	243	331.867N	0.520	254	335.132	0.240	259	335.434	1.750	257	336.731	0.990	547
328.224	0.600	243	331.868N	0.820	254	335.140	0.590	259	335.435	2.100	257	336.732	1.010	547
328.226	0.600	243	331.870N	1.410	254	335.142	0.740	259	335.436	2.500	257	336.733	1.040	547
328.228	7.500	94	331.871N	2.190	254	335.164	1.150	259	335.531	0.440	261	336.734	1.100	547
328.230	12.100	94	331.874N	0.950	254	335.165	1.700	259	335.532	0.560	261	336.735	1.190	547
328.233	7.500	143	331.875N	2.000	254	335.230	0.280	256	335.541	0.820	261	336.736	1.240	547
328.235	12.100	143	331.876N	3.100	254	335.231	0.300	256	335.542	0.940	261	336.737	1.250	547
328.238	6.500	193	331.877N	1.530	254	335.232	0.390	256	335.551	1.700	261	336.738	1.270	547
328.240	11.200	193	331.878N	3.000	254	335.233	0.550	256	335.552	1.850	261	336.739	1.400	547
328.249F	0.050	222	331.879N	2.250	254	335.234	0.410	256	335.561	3.300	261	336.740	1.370	547
328.257F	0.160	222	332.210	0.090	252	335.235	0.420	256	335.562	4.050	261	336.741	1.380	547
328.260	0.550	91	332.310	0.150	252	335.236	0.540	256	335.563	5.800	261	336.742	1.600	547
328.261	0.750	91	332.320	0.160	252	335.237	0.670	256	335.571	9.500	261	336.743	1.520	547
328.262	0.700	91	332.410	0.230	252	335.238	0.690	256	335.625	0.350	373	336.744	1.560	547
328.272	0.640	91	332.420	0.250	252	335.239	0.790	256	335.762	0.870	261	336.745	1.600	547
328.273	0.600	243	332.430	0.300	252	335.240	0.610	256	335.763	1.550	261	336.747	1.750	547
328.277F	0.220	191	332.510	0.440	252	335.241	0.630	256	335.764	0.500	260	336.749	1.920	547
328.278F	0.200	191	332.511	0.440	252	335.242	0.690	256	335.768	0.780	260	336.751	2.000	547
328.279F	0.180	191	332.520	0.550	252	335.243	0.820	256	335.769	1.000	260	336.753	2.400	547
328.280F	0.140	222	332.521	0.420	252	335.244	0.840	256	335.902	2.750	445	336.755	2.430	547
328.281F	0.080	222	332.530	0.670	252	335.245	0.900	256	335.903	2.100	445	336.757	2.600	547
328.289	0.900	91	332.531	0.440	252	335.246	0.920	256	335.904	1.750	445	336.759	2.950	547
328.308	0.480	91	332.541	0.540	252	335.247	1.050	256	335.905	1.450	445	336.761	2.840	547
328.321	0.850	243	332.545	0.700	252	335.248	1.660	256	335.906	2.700	445	336.905	0.020	514
328.322	0.940	243	332.610	0.910	252	335.249	0.800	256	335.912	0.850	445	337.316	0.740	546
328.370	1.900	246	332.611	0.790	252	335.250	2.900	256	335.913	0.400	445	337.317	0.750	546
328.371	1.900	246	332.620	0.800	252	335.251	3.400	256	335.915	0.200	445	337.318	0.760	546
328.372	2.000	246	332.621	0.700	252	335.320	0.470	449	336.171	0.410	548	337.319	0.760	546
328.373	2.100	246	332.630	0.960	252	335.321	0.740	449	336.172	0.480	548	337.320	0.780	546
328.374	2.100	246	332.631	0.750	252	335.322	0.950	449	336.173	0.580	548	337.321	0.780	546

List with Order Numbers and Weights

Order No.	Weight (kg)	Page	Order No.	Weight (kg)	Page	Order No.	Weight (kg)	Page	Order No.	Weight (kg)	Page	Order No.	Weight (kg)	Page
337.322	0.800	546	490.214	2.980	150	613.408	0.040	406	615.229	0.400	407	615.387B	0.140	415
337.323	0.820	546	490.216	3.040	150	613.409	0.040	406	615.230	0.030	413	615.388	0.040	415
337.324	0.840	546	490.218	3.050	150	613.410	0.035	406	615.231	0.040	413	615.390	0.340	416
337.325	0.860	546	490.220	3.110	150	613.411	0.029	406	615.232	0.093	407	615.392	0.012	414
337.326	0.880	546	490.225	3.850	150	613.412	0.025	406	615.233	0.250	407	615.394	0.050	412
337.327	0.920	546	490.232	4.500	150	613.413	0.018	406	615.234	0.065	407	615.395	0.050	412
337.328	0.940	546	490.240	5.500	150	613.414	0.015	406	615.239	0.170	407	615.401	0.015	413
337.329	0.960	546	490.506	0.990	141	613.422	0.125	400	615.240	0.215	407	615.402	0.015	413
337.330	0.990	546	490.508	0.980	141	613.423	0.120	400	615.243	0.155	407	615.403	0.015	413
337.416	0.750	546	490.510	1.050	141	613.424	0.130	400	615.250	0.140	407	615.404	0.015	413
337.417	0.750	546	490.512	1.030	141	613.425	0.130	400	615.251	0.250	407	615.405	0.015	413
337.418	0.780	546	490.514	1.080	141	613.426	0.120	400	615.252	0.300	423	615.406	0.015	413
337.419	0.790	546	490.516	1.060	141	613.427	0.120	400	615.253	0.450	423	615.407	0.015	413
337.420	0.800	546	490.518	1.250	141	613.428	0.150	400	615.256	0.180	423	615.408	0.015	413
337.421	0.800	546	490.520	1.180	141	613.429	0.120	400	615.257	0.370	423	615.409	0.015	413
337.422	0.830	546	490.556	1.150	141	613.430	0.130	400	615.258	0.520	423	615.420	0.020	412
337.423	0.860	546	490.558	1.140	141	613.432	0.110	400	615.262	0.140	423	615.421	0.020	412
337.424	0.880	546	490.560	1.290	141	613.433	0.110	400	615.264	0.240	412	615.422	0.020	412
337.425	0.900	546	490.562	1.250	141	613.434	0.110	400	615.265	0.210	423	615.423	0.020	412
337.426	0.960	546	490.566	1.310	141	613.435	0.110	400	615.266	0.370	423	615.424	0.020	412
337.427	1.000	546	490.570	1.560	141	613.436	0.110	400	615.267	0.290	423	615.425	0.020	412
337.428	1.020	546	490.606	2.720	141	613.437	0.130	400	615.268	0.220	407	615.426	0.020	412
337.429	1.060	546	490.608	2.720	141	613.438	0.130	400	615.269	0.350	407	615.427	0.020	412
337.430	1.100	546	490.610	2.780	141	613.439	0.130	400	615.271	0.010	427	615.428	0.020	412
389.365	1.250	253	490.612	2.770	141	613.440	0.120	400	615.272	0.012	427	615.429	0.020	412
389.366	2.550	253	490.614	2.820	141	615.080	0.010	401	615.273	0.015	427	615.501	0.020	430
389.367	5.180	253	490.616	2.800	141	615.081	0.010	401	615.280	0.015	429	615.502	0.020	430
395.161	0.010	504	490.618	2.940	141	615.082	0.020	407	615.281	0.019	429	615.503	0.020	430
395.170	0.020	504	490.620	2.920	141	615.083	0.020	407	615.282	0.025	429	615.504	0.020	430
470.108	1.800	399	490.625	3.500	141	615.084	0.030	407	615.283	0.030	405	615.505	0.020	407
470.301	0.300	440	490.656	3.500	141	615.085	0.030	407	615.284	0.035	429	615.506	0.022	407
470.401	0.580	440	490.658	3.500	141	615.086	0.030	401	615.285	0.040	429	615.507	0.023	430
470.501	1.120	440	490.660	3.500	141	615.087	0.050	401	615.286	0.040	429	615.508	0.023	430
470.601	2.190	440	490.662	3.500	141	615.201	0.020	407	615.287	0.050	429	615.509	0.024	430
470.602	2.890	440	490.664	3.600	141	615.202	0.040	407	615.288	0.030	429	615.511	0.030	430
470.801	5.200	440	490.666	3.600	141	615.203	0.008	401	615.289	0.030	429	615.522	0.020	430
472.051	0.260	272	490.668	3.900	141	615.203A	0.008	401	615.290	0.030	429	615.524	0.020	430
472.052	0.005	382	490.670	3.900	141	615.204	0.015	401	615.291	0.030	429	615.525	0.020	430
472.061	0.280	272	490.675	4.710	141	615.204A	0.016	401	615.292	0.035	405	615.530	0.020	430
472.062	0.007	382	613.202	0.012	406	615.205	0.020	401	615.300	0.016	423	615.531	0.030	430
472.201	0.300	386	613.203	0.011	406	615.206	0.115	401	615.301	0.015	423	615.541	0.003	433
472.301	0.300	386	613.204	0.012	406	615.207	0.045	401	615.302	0.018	423	615.542	0.003	433
472.401	0.550	386	613.205	0.010	406	615.208	0.085	401	615.303	0.020	423	615.543	0.003	433
472.501	1.100	386	613.206	0.009	406	615.209	0.160	405	615.304	0.055	412	615.544	0.003	433
472.601	2.100	386	613.207	0.007	406	615.210	0.235	405	615.305	0.060	412	615.545	0.003	433
472.602	2.170	386	613.208	0.005	406	615.211	0.016	407	615.306	0.080	412	615.546	0.004	433
472.701	4.900	386	613.304	0.012	406	615.212	0.045	407	615.354	0.080	423	615.547	0.004	433
472.703	5.900	386	613.305	0.020	406	615.213	0.035	401	615.355	0.105	423	615.551	0.003	433
490.106	0.880	150	613.306	0.019	406	615.214	0.025	407	615.356	0.150	423	615.552	0.003	433
490.108	0.900	150	613.307	0.019	406	615.215	0.070	407	615.365	0.005	423	615.553	0.003	433
490.110	0.980	150	613.308	0.015	406	615.216	0.025	407	615.366	0.010	423	615.554	0.003	433
490.112	1.070	150	613.309	0.019	406	615.217	0.040	407	615.367	0.015	423	615.555	0.003	433
490.114	1.080	150	613.310	0.008	406	615.218	0.060	407	615.369	0.105	423	615.561	0.003	433
490.116	1.270	150	613.323	0.020	400	615.219	0.140	407	615.370	0.120	423	615.562	0.003	433
490.118	1.280	150	613.324	0.065	400	615.220	0.020	413	615.371	0.170	423	615.563	0.003	433
490.120	1.320	150	613.325	0.060	400	615.221	0.300	407	615.372	0.200	423	615.564	0.003	433
490.125	2.410	150	613.326	0.060	400	615.223	0.100	407	615.373	0.260	423	615.565	0.003	433
490.132	2.600	150	613.327	0.060	400	615.224	0.200	407	615.374	0.070	423	615.566	0.003	433
490.206	2.670	150	613.404	0.050	406	615.225	0.140	407	615.375	0.100	423	615.571	0.003	433
490.208	2.710	150	613.405	0.050	406	615.226	0.125	407	615.376	0.130	423	615.572	0.003	433
490.210	2.810	150	613.406	0.045	406	615.227	0.260	407	615.377	0.170	423	615.573	0.003	433
490.212	2.940	150	613.407	0.045	406	615.228	0.040	413	615.378	0.220	423	615.574	0.004	433

List with Order Numbers and Weights

Order No.	Weight (kg)	Page	Order No.	Weight (kg)	Page	Order No.	Weight (kg)	Page	Order No.	Weight (kg)	Page	Order No.	Weight (kg)	Page
615.575	0.004	433	626.452	0.020	443	639.145	0.060	501	639.405	0.170	391	639.561	0.200	501
615.580	0.020	431	626.453	0.020	443	639.146	0.060	501	639.406	0.380	391	639.562	0.200	501
615.581	0.020	431	626.462	0.050	443	639.147	0.120	388	639.407	0.660	391	639.563	0.400	387
615.582	0.020	431	626.463	0.040	443	639.151	0.100	501	639.408	0.770	391	639.565	0.250	501
615.583	0.020	431	626.472	0.040	457	639.152	0.100	501	639.409	1.040	391	639.566	0.250	501
615.584	0.020	431	626.473	0.060	457	639.153	0.200	388	639.410	1.160	391	639.567	0.500	387
615.585	0.023	431	626.901	0.005	442	639.155	0.130	501	639.411	0.010	501	639.571	0.385	501
615.586	0.023	431	626.902	0.010	442	639.156	0.130	501	639.412	0.010	501	639.572	0.385	501
615.587	0.024	431	626.903	0.010	442	639.157	0.260	388	639.413	0.020	387	639.573	0.770	387
615.588	0.024	431	626.904	0.030	442	639.161	0.215	501	639.415	0.020	501	639.575	0.460	501
615.589	0.025	431	626.905	0.040	442	639.162	0.215	501	639.416	0.020	501	639.576	0.460	501
615.590	0.003	433	626.906	0.130	442	639.163	0.430	388	639.417	0.040	387	639.577	0.930	387
615.903	0.025	511	626.907	0.025	414	639.165	0.225	501	639.421	0.020	501	639.581	0.550	501
615.904	0.005	506	626.908	0.055	414	639.166	0.225	501	639.422	0.020	501	639.582	0.550	501
625.020	0.010	448	626.909	0.090	414	639.167	0.550	388	639.423	0.040	387	639.583	1.090	387
626.111	0.010	441	626.910	0.110	414	639.171	0.405	501	639.425	0.020	501	639.585	0.650	501
626.112	0.010	441	626.916	0.240	442	639.172	0.405	501	639.426	0.020	501	639.586	0.650	501
626.113	0.010	441	626.917	0.190	457	639.173	0.810	388	639.427	0.040	387	639.587	1.290	387
626.121	0.010	441	626.935	0.060	444	639.175	0.550	501	639.431	0.020	501	639.653	0.330	392
626.122	0.010	441	626.936	0.110	444	639.176	0.550	501	639.432	0.020	501	639.663	0.610	392
626.123	0.010	441	626.937	0.130	444	639.177	1.100	388	639.433	0.060	387	639.667	0.550	392
626.131	0.009	441	626.938	0.090	444	639.181	0.550	501	639.435	0.040	501	639.673	0.800	392
626.132	0.010	441	626.945	0.060	444	639.182	0.550	501	639.436	0.040	501	639.677	1.360	392
626.133	0.010	441	626.946	0.110	444	639.183	1.100	388	639.437	0.060	387	639.683	1.460	392
626.141	0.013	441	626.947	0.130	444	639.185	0.660	501	639.441	0.030	501	639.687	1.740	392
626.142	0.015	441	626.948	0.150	444	639.186	0.660	501	639.442	0.030	501	639.690	0.010	511
626.143	0.018	441	627.121	0.020	508	639.187	1.320	388	639.443	0.060	387	639.691	0.004	511
626.151	0.020	441	627.131	0.050	508	639.191	0.100	502	639.445	0.060	501	639.693	0.004	511
626.152	0.025	441	627.141	0.050	508	639.192	0.150	502	639.446	0.060	501	639.913	0.050	502
626.153	0.030	441	627.151	0.050	508	639.193	0.200	502	639.447	0.060	387	639.914	0.080	502
626.161	0.045	441	627.161	0.050	508	639.194	0.300	502	639.451	0.095	501	639.915	0.100	502
626.162	0.070	441	637.940	0.710	456	639.195	0.350	502	639.452	0.095	501	639.916	0.150	502
626.163	0.080	441	637.941	0.710	456	639.196	0.400	502	639.453	0.190	387	639.917	0.260	502
626.231	0.008	507	637.942	0.750	456	639.197	0.450	502	639.455	0.095	501	639.918	0.400	502
626.241	0.014	465	637.943	0.700	456	639.241	0.550	501	639.456	0.095	501	651.623	0.001	471
626.251	0.022	465	637.951	0.750	456	639.242	0.550	501	639.457	0.190	387	651.632	0.001	471
626.261	0.035	465	637.953	0.750	456	639.243	0.110	389	639.461	0.200	501	651.702	0.001	471
626.271	0.040	457	637.959	0.380	461	639.251	0.120	501	639.462	0.200	501	651.713	0.001	471
626.272	0.050	457	637.961	0.590	461	639.252	0.120	501	639.463	0.400	387	651.723	0.001	471
626.273	0.060	457	637.962	0.010	511	639.253	0.240	389	639.465	0.200	501	651.725	0.001	471
626.322	0.010	442	639.104	0.100	390	639.255	0.120	501	639.466	0.200	501	651.734	0.001	471
626.323	0.010	442	639.105	0.180	390	639.257	0.240	389	639.467	0.400	387	651.735	0.001	471
626.331	0.010	442	639.106	0.380	390	639.261	0.225	501	639.471	0.410	501	651.736	0.001	471
626.332	0.010	442	639.107	0.110	390	639.262	0.225	501	639.472	0.410	501	651.737	0.001	471
626.333	0.010	442	639.108	0.780	390	639.263	0.450	389	639.473	0.820	387	651.738	0.001	471
626.341	0.010	442	639.109	1.050	390	639.265	0.275	501	639.475	0.410	501	651.802	0.001	471
626.342	0.020	442	639.110	1.150	390	639.266	0.275	501	639.476	0.410	501	651.813	0.001	471
626.343	0.020	442	639.111	0.010	501	639.267	0.550	389	639.477	0.820	387	651.823	0.001	471
626.351	0.020	442	639.112	0.010	501	639.271	0.425	501	639.481	0.550	501	651.824	0.001	471
626.352	0.030	442	639.113	0.020	388	639.272	0.425	501	639.482	0.550	501	651.825	0.001	471
626.353	0.035	442	639.121	0.010	501	639.273	0.850	389	639.483	1.100	387	651.833	0.001	471
626.361	0.030	442	639.122	0.010	501	639.275	0.540	501	639.485	0.650	501	651.834	0.001	471
626.362	0.060	442	639.123	0.020	388	639.276	0.540	501	639.486	0.650	501	651.835	0.001	471
626.363	0.090	442	639.131	0.030	501	639.277	1.080	389	639.487	1.300	387	651.837	0.001	471
626.371	0.040	457	639.132	0.030	501	639.281	0.580	501	639.490	0.200	502	651.838	0.002	471
626.372	0.060	457	639.133	0.060	388	639.282	0.580	501	639.491	0.300	502	651.839	0.002	471
626.422	0.005	443	639.135	0.040	501	639.283	1.160	389	639.492	0.400	502	651.840	0.001	471
626.423	0.010	443	639.136	0.040	501	639.285	0.650	501	639.493	0.500	502	651.841	0.001	471
626.432	0.010	443	639.137	0.080	388	639.286	0.650	501	639.494	0.600	502	651.842	0.001	471
626.433	0.010	443	639.141	0.045	501	639.287	1.300	389	639.495	0.600	502	651.843	0.001	471
626.442	0.010	443	639.142	0.045	501	639.403	0.120	391	639.496	0.800	502	654.150	0.001	479
626.443	0.020	443	639.143	0.090	388	639.404	0.840	391	639.497	0.800	502	654.152	0.001	479

List with Order Numbers and Weights

Order No.	Weight (kg)	Page	Order No.	Weight (kg)	Page	Order No.	Weight (kg)	Page	Order No.	Weight (kg)	Page	Order No.	Weight (kg)	Page
654.158	0.002	479	655.301B	0.001	472	655.622	0.001	484	656.122	0.001	493	689.516	0.001	472
654.168	0.001	479	655.302A	0.001	472	655.630	0.001	484	656.123	0.001	493	689.517	0.001	472
654.183	0.002	479	655.302B	0.001	472	655.631	0.001	484	656.130	0.001	493	689.518	0.001	472
654.240	0.004	480	655.303A	0.002	472	655.632	0.001	484	656.131	0.001	493	690.101	0.002	500
654.250	0.004	480	655.303B	0.002	472	655.640	0.002	485	656.140	0.001	493	690.102	0.004	503
654.251	0.003	480	655.305	0.001	472	655.641	0.002	485	656.141	0.001	493	690.103	0.004	503
654.259	0.004	480	655.306	0.001	472	655.642	0.002	485	656.142	0.001	493	690.104	0.005	503
654.277	0.004	480	655.310	0.002	471	655.644	0.002	485	656.143	0.001	493	690.105	0.025	500
654.287	0.004	480	655.311A	0.001	472	655.650	0.004	485	656.144	0.001	493	690.106	0.030	500
654.340	0.010	481	655.313	0.001	472	655.651	0.004	485	656.145	0.001	493	690.107	0.005	500
654.350	0.010	481	655.314	0.001	472	655.652	0.004	485	656.146	0.001	493	690.108	0.005	500
654.351	0.010	481	655.315	0.001	471	655.654	0.004	485	656.147	0.001	493	690.113	0.004	506
654.354	0.010	481	655.316	0.001	472	655.660	0.010	486	656.150	0.001	493	690.115	0.003	508
654.387	0.008	481	655.317	0.001	471	655.661	0.010	486	656.151	0.001	493	690.121	0.053	509
654.837	0.001	475	655.318	0.001	473	655.662	0.010	486	656.152	0.001	493	690.124	0.005	509
654.840A	0.001	475	655.319	0.001	473	655.664	0.010	486	656.153	0.001	493	690.131	0.010	499
654.846	0.001	475	655.320	0.001	473	655.670	0.020	486	656.201	0.001	494	690.132	0.010	510
654.847	0.001	475	655.321A	0.001	472	655.671	0.020	486	656.202	0.001	494	690.135	0.001	507
654.850A	0.001	475	655.322	0.001	472	655.821	0.001	494	656.203	0.001	494	690.136	0.001	507
654.851A	0.001	475	655.322A	0.001	472	655.822	0.001	494	656.204	0.001	494	690.137	0.003	507
654.852	0.001	475	655.324	0.001	472	655.910	0.002	482	656.210	0.001	494	690.138	0.004	507
654.853	0.001	475	655.326	0.003	472	655.911	0.002	482	656.211	0.001	494	690.139	0.002	507
654.856	0.001	475	655.327	0.001	473	655.912	0.002	482	656.212	0.001	494	690.140	0.004	507
654.858	0.001	475	655.328	0.001	473	655.913	0.002	482	656.300	0.001	494	690.141	0.007	507
654.877	0.001	475	655.331A	0.001	472	655.920	0.002	482	656.301	0.001	494	690.150	0.005	506
654.879	0.001	475	655.334	0.001	472	655.921	0.002	482	656.302	0.001	494	690.156	0.005	504
654.888	0.001	475	655.354	0.001	472	655.922	0.002	482	656.303	0.001	494	690.157	0.005	500
654.889	0.001	475	655.363	0.001	473	655.923	0.002	482	656.310	0.001	494	690.159	0.100	503
654.930A	0.004	476	655.364	0.001	472	655.930	0.003	483	656.311	0.001	494	690.163	0.020	500
654.935	0.004	476	655.369	0.001	473	655.931	0.003	483	656.312	0.001	494	690.172	0.019	499
654.937	0.004	476	655.370	0.001	473	655.932	0.003	483	656.313	0.001	494	690.173	0.007	500
654.940A	0.004	476	655.371	0.001	473	655.933	0.003	483	656.320	0.001	494	690.176	0.005	508
654.942	0.004	476	655.372	0.001	473	655.940	0.001	475	656.321	0.001	494	690.177	0.005	508
654.945	0.004	476	655.373	0.001	473	655.941	0.001	475	656.330	0.001	494	690.178	0.005	508
654.947	0.004	476	655.374	0.002	471	655.942	0.001	475	656.331	0.001	494	690.179	0.001	508
654.949	0.004	476	655.375	0.001	473	656.000	0.001	492	656.340	0.001	494	690.180	0.003	508
654.950	0.003	476	655.378	0.001	473	656.001	0.001	492	656.341	0.001	494	690.182	0.003	508
654.952	0.004	476	655.379	0.002	473	656.004	0.001	492	656.342	0.001	494	690.183	0.020	506
654.955	0.003	476	655.380	0.001	473	656.005	0.001	492	656.343	0.001	494	690.184	0.007	500
654.957	0.003	476	655.381	0.001	473	656.011	0.001	492	656.351	0.001	494	690.186	0.008	500
654.959	0.003	476	655.383	0.001	473	656.012	0.001	492	656.352	0.001	494	690.188	0.014	500
654.964	0.004	477	655.384	0.002	471	656.015	0.001	492	663.110	0.040	571	690.189	0.010	500
654.965	0.004	477	655.385	0.001	473	656.016	0.001	492	663.120	0.070	571	690.191	0.005	500
654.968	0.004	477	655.386	0.001	473	656.020	0.001	492	663.121	0.140	571	690.192	0.007	500
654.969	0.004	477	655.387	0.001	473	656.021	0.001	492	663.130	0.090	571	690.193	0.009	500
654.977	0.004	476	655.388	0.001	473	656.022	0.001	492	663.131	0.180	571	690.194	0.010	500
654.978	0.003	477	655.389	0.001	473	656.040	0.001	492	663.140	0.100	571	690.195	0.014	500
654.979	0.003	477	655.390	0.001	473	656.041	0.001	492	663.141	0.210	571	690.196	0.017	500
654.983	0.020	478	655.393	0.001	473	656.042	0.001	492	663.150	0.500	571	690.197	0.020	500
654.986	0.020	478	655.395	0.001	473	656.043	0.001	492	663.151	0.950	571	690.208	0.001	500
654.987	0.004	476	655.397	0.002	473	656.050	0.001	492	663.160	0.640	571	690.320	0.009	514
654.988	0.010	477	655.398	0.001	473	656.051	0.001	492	663.161	1.250	571	690.323	0.070	506
654.989	0.010	477	655.399	0.001	473	656.100	0.005	493	663.170	0.600	571	690.324	0.070	506
654.990A	0.010	477	655.600	0.001	470	656.101	0.001	493	663.181	0.010	571	690.326	0.040	514
654.991	0.010	477	655.601	0.001	470	656.102	0.001	493	663.185	0.040	571	690.400	0.001	511
654.992	0.009	477	655.602	0.001	470	656.103	0.001	493	663.191	0.005	571	690.410	0.001	500
654.993A	0.010	477	655.603	0.001	470	656.110	0.005	493	663.195	0.030	571	690.413	0.020	500
654.995	0.003	477	655.604	0.001	470	656.111	0.001	493	689.001	0.020	443	690.414	0.001	500
654.996	0.020	478	655.605	0.001	470	656.112	0.001	493	689.007	0.050	443	690.416	0.001	500
654.997	0.020	478	655.606	0.001	470	656.113	0.001	493	689.189	0.030	457	690.417	0.001	500
654.998	0.016	478	655.620	0.001	484	656.120	0.001	493	689.197	0.020	443	690.418	0.001	500
655.301A	0.001	472	655.621	0.001	484	656.121	0.001	493	689.198	0.020	443	690.419	0.001	500

List with Order Numbers and Weights

Order No.	Weight (kg)	Page	Order No.	Weight (kg)	Page	Order No.	Weight (kg)	Page	Order No.	Weight (kg)	Page	Order No.	Weight (kg)	Page
690.421	0.001	500	690.622	0.001	500	691.501	0.001	498	694.167	0.017	515	800.024	4.300	84
690.425	0.001	500	690.658	0.005	500	691.502	0.002	498	694.168	0.017	515	800.025	4.400	84
690.431	0.001	498	690.666	0.005	499	691.503	0.006	498	694.169	0.017	515	800.026	4.500	84
690.432	0.001	498	690.667	0.030	499	691.504	0.011	498	694.170	0.017	515	800.027	3.920	84
690.433	0.002	498	690.668	0.040	500	691.505	0.021	498	694.171	0.017	515	800.029	1.250	71
690.434	0.003	498	690.716	0.019	511	691.506	0.050	498	694.172	0.017	515	800.031	0.560	71
690.435	0.003	498	690.800	0.001	515	691.507	0.110	498	694.173	0.017	515	800.045	2.310	585
690.436	0.010	498	690.801	0.001	515	691.605	0.015	513	694.174	0.017	515	800.046	0.010	528
690.437	0.050	498	690.802	0.001	515	691.606	0.022	513	694.175	0.017	515	800.047	0.010	528
690.440	0.001	500	690.803	0.005	515	691.607	0.045	513	694.176	0.017	515	800.048	0.002	528
690.449	0.002	500	690.804	0.010	515	691.608	0.075	513	694.177	0.017	515	800.049	0.010	528
690.451	0.001	500	690.805	0.018	515	691.609	0.075	513	694.178	0.017	515	800.051	0.005	528
690.452	0.005	500	690.806	0.030	515	691.637	0.088	499	694.179	0.017	515	800.052	0.005	528
690.457	0.003	500	690.807	0.060	515	691.755	0.015	502	694.180	0.017	515	800.053	0.010	528
690.459	0.001	500	690.808	0.160	515	691.756	0.015	502	694.181	0.105	515	800.054	1.040	584
690.460	0.002	500	690.809	0.170	515	691.757	0.015	502	694.182	0.105	515	800.058	0.600	59
690.462	0.001	500	690.810	0.100	515	692.406	0.003	500	694.183	0.105	515	800.063	0.530	88
690.464	0.002	500	690.811	0.014	500	692.409	0.002	500	694.184	0.105	515	800.064	1.000	101
690.465	0.002	500	690.812	0.015	500	693.131	0.001	503	694.185	0.105	515	800.065	2.800	584
690.466	0.001	500	690.813	0.016	500	693.175	0.001	500	694.186	0.105	515	800.066	1.110	96
690.467	0.001	500	690.814	0.020	500	693.176	0.001	500	694.187	0.105	515	800.074	1.820	96
690.469	0.005	500	690.816	0.050	500	693.177	0.001	500	694.188	0.105	515	800.075	1.720	96
690.477	0.002	500	690.817	0.045	500	693.178	0.001	500	694.189	0.105	515	800.079	1.750	96
690.478	0.003	500	690.819	0.050	500	693.179	0.001	500	694.190	0.105	515	800.080	2.000	96
690.479	0.006	500	690.832	0.001	515	693.181	0.003	506	694.191	0.105	515	800.081	2.780	96
690.480	0.010	500	690.833	0.001	515	693.182	0.004	512	694.192	0.105	515	800.085	1.500	83
690.481	0.017	500	690.834	0.002	514	693.183	0.017	509	694.193	0.105	515	800.086	1.700	83
690.482	0.020	500	690.836	0.004	514	693.184	0.024	509	694.194	0.105	515	800.087	2.000	83
690.483	0.035	500	690.837	0.010	514	693.186	0.001	503	694.806	0.002	514	800.088	1.180	83
690.484	0.045	500	690.838	0.010	514	693.187	0.001	500	694.807	0.004	514	800.092	1.400	83
690.487A	0.008	500	690.843	0.010	514	693.289	0.001	508	694.808	0.004	514	800.093	1.520	83
690.488	0.007	500	690.861	0.800	515	693.304	0.325	498	694.809	0.004	514	800.094	1.700	83
690.489	0.001	500	690.899	0.005	515	693.305	0.325	498	694.810	0.009	514	800.095	2.000	83
690.510	0.010	500	690.900	0.001	500	693.306	0.325	498	694.815	0.009	514	800.096	1.340	83
690.511	0.001	500	690.901	0.001	500	694.101	0.005	514	694.820	0.010	514	800.099	1.400	83
690.512	0.002	500	690.902	0.002	500	694.102	0.005	514	695.101	0.020	502	800.100	1.600	83
690.513	0.003	500	690.903	0.002	500	694.103	0.005	514	695.102	0.020	502	800.101	1.800	83
690.514	0.004	500	690.904	0.003	500	694.105	0.005	514	719.000	0.050	398	800.104	1.800	83
690.515	0.008	500	690.905	0.003	500	694.110	0.005	514	800.000	4.100	84	800.105	1.600	83
690.529	0.001	500	690.906	0.003	500	694.120	0.005	514	800.001	4.060	84	800.106	1.900	83
690.538	0.001	500	690.907	0.003	500	694.121	0.005	514	800.002	4.040	84	800.107	2.300	83
690.541	0.010	500	690.908	0.004	500	694.122	0.005	514	800.003	4.700	84	800.108	1.300	83
690.549	0.001	500	690.912	0.001	500	694.123	0.005	514	800.004	4.800	84	800.109	1.600	83
690.550	0.001	500	690.913	0.001	500	694.124	0.005	514	800.005	5.500	84	800.110	1.900	83
690.551	0.001	500	690.940	0.001	508	694.130	0.005	514	800.006	6.060	84	800.111	1.380	83
690.552	0.004	500	690.943	0.005	500	694.131	0.005	514	800.007	4.400	84	800.112	1.680	83
690.553	0.005	500	690.953	0.005	508	694.136	0.005	514	800.008	4.340	84	800.113	2.000	83
690.573	0.001	500	690.954	0.005	508	694.137	0.005	514	800.009	4.600	84	800.114	2.400	83
690.576	0.008	500	690.964	0.003	500	694.138	0.005	514	800.010	4.700	84	800.115	1.420	83
690.577	0.010	500	690.970	0.003	500	694.141	0.005	514	800.011	4.800	84	800.116	1.600	83
690.578	0.010	500	690.978	0.001	500	694.142	0.005	514	800.012	7.500	84	800.117	2.400	86
690.579	0.014	500	690.981	0.003	514	694.143	0.005	514	800.013	9.100	84	800.118	3.000	86
690.580	0.020	500	690.984	0.050	510	694.144	0.005	514	800.014	4.700	84	800.119	3.600	86
690.582	0.007	500	690.985	0.050	510	694.145	0.005	514	800.015	4.260	84	800.120	1.800	86
690.583	0.002	500	690.986	0.050	510	694.150	0.005	514	800.016	5.100	85	800.121	2.600	86
690.585	0.004	500	690.987	0.030	510	694.160	0.090	515	800.017	6.000	85	800.122	2.800	86
690.586	0.003	500	690.990	0.010	510	694.161	0.090	515	800.018	6.900	85	800.123	3.400	86
690.591	0.005	500	690.991	0.010	510	694.162	0.090	515	800.019	8.400	85	800.124	2.200	86
690.594	0.004	498	690.994	0.040	514	694.163	0.090	515	800.020	9.100	85	800.128	1.480	83
690.595	0.003	500	690.995	0.003	500	694.164	0.090	515	800.021	4.700	85	800.129	1.700	83
690.611	0.001	514	690.996	0.010	500	694.165	0.090	515	800.022	6.100	85	800.130	1.900	83
690.614	0.001	514	690.997	0.010	500	694.166	0.090	515	800.023	3.860	84	800.131	1.180	83

List with Order Numbers and Weights

Order No.	Weight (kg)	Page	Order No.	Weight (kg)	Page	Order No.	Weight (kg)	Page	Order No.	Weight (kg)	Page	Order No.	Weight (kg)	Page
800.135	1.300	83	800.270	4.600	84	800.352	4.400	90	800.426	0.120	339	800.766	1.380	248
800.136	1.500	83	800.271	4.700	84	800.354	3.780	90	800.427	0.120	339	800.767	0.750	248
800.137	1.700	83	800.272	4.000	84	800.355	3.900	90	800.428	0.120	339	800.774	1.050	301
800.138	2.000	83	800.273	4.600	84	800.356	4.000	87	800.429	0.120	339	800.775	1.500	245
800.139	1.200	83	800.274	4.700	84	800.357	4.400	87	800.430	0.130	339	800.776	2.470	304
800.143	1.400	83	800.275	4.400	84	800.358	4.900	87	800.431	0.130	339	800.777	2.400	304
800.144	1.820	74	800.276	4.500	84	800.359	4.500	87	800.432	0.130	339	800.778	3.400	304
800.146	2.780	74	800.277	4.500	84	800.360	5.000	87	800.433	0.130	339	800.779	2.600	304
800.147	2.260	74	800.278	4.160	75	800.361	4.600	87	800.434	0.130	339	800.780	1.900	301
800.148	3.200	74	800.279	4.500	75	800.362	5.200	87	800.435	0.140	339	800.781	1.860	301
800.151	3.250	288	800.280	4.930	75	800.363	4.400	87	800.436	0.140	339	800.783	2.460	244
800.152	3.250	288	800.281	5.600	75	800.364	3.900	87	800.437	0.140	339	800.787	2.800	244
800.153	2.740	288	800.282	4.320	75	800.365	3.900	87	800.438	0.140	339	800.788	1.800	244
800.154	1.110	289	800.283	4.800	75	800.366	4.750	101	800.439	0.140	339	800.789	2.100	244
800.157	1.760	287	800.284	5.300	75	800.367	5.120	101	800.450	0.030	374	800.790	2.300	244
800.158	1.280	104	800.285	5.940	75	800.368	5.950	101	800.463	0.090	374	800.806	1.900	241
800.159	1.420	104	800.286	7.960	75	800.369	4.140	101	800.464	0.070	374	800.808	1.600	241
800.160	1.660	104	800.287	4.600	75	800.370	4.670	101	800.468	0.230	375	800.812	2.000	241
800.161	1.500	90	800.288	5.160	75	800.371	5.030	101	800.472	0.200	375	800.814	2.000	241
800.162	1.600	90	800.289	5.840	75	800.372	5.900	101	800.483	0.053	581	800.815	2.000	241
800.163	1.160	88	800.290	6.800	75	800.373	6.700	101	800.484	0.056	581	800.816	2.000	241
800.164	1.780	90	800.291	4.640	75	800.374	4.100	101	800.488	0.002	528	800.818	1.700	241
800.165	2.060	90	800.292	5.440	75	800.375	4.180	101	800.557	1.400	230	800.819	2.100	241
800.167	1.300	90	800.293	6.380	75	800.376	4.600	101	800.587	0.002	537	800.821	1.700	241
800.168	1.030	88	800.294	7.440	75	800.377	4.950	101	800.597	0.790	71	800.822	1.320	241
800.169	1.400	90	800.295	10.450	75	800.378	5.800	101	800.664	0.030	349	800.823	2.380	241
800.170	1.500	87	800.297	4.920	102	800.379	6.650	101	800.665	0.620	349	800.825	1.740	241
800.171	1.700	87	800.299	5.200	102	800.380	4.720	101	800.666	0.600	349	800.826	2.440	241
800.172	1.200	87	800.301	5.960	102	800.381	6.020	101	800.668	0.600	349	800.827	2.800	241
800.173	1.200	87	800.303	6.300	102	800.382	5.450	101	800.670	0.570	349	800.842	1.140	239
800.174	1.900	101	800.305	7.950	102	800.383	6.820	101	800.671	0.500	349	800.843	1.720	239
800.175	1.700	101	800.307	6.440	102	800.384	7.960	101	800.672	0.550	349	800.844	2.500	239
800.176	1.850	101	800.308	7.900	102	800.385	4.680	101	800.673	0.380	349	800.845	1.380	239
800.177	1.640	101	800.312	9.400	288	800.386	5.480	101	800.674	0.570	349	800.846	2.060	239
800.178	1.750	101	800.313	9.200	288	800.387	6.230	101	800.675	0.590	349	800.847	3.100	239
800.179	1.550	101	800.314	7.660	288	800.388	7.160	101	800.676	0.500	235	800.848	1.520	239
800.180	3.050	101	800.315	4.050	289	800.389	8.500	101	800.678	0.600	235	800.849	2.200	239
800.184	5.200	584	800.316	4.460	289	800.390	5.280	101	800.680	0.800	237	800.850	2.870	239
800.204	4.080	97	800.317	4.750	289	800.391	7.150	101	800.682	0.800	237	800.851	1.920	239
800.205	4.420	97	800.318	5.300	289	800.403	0.050	338	800.683	0.400	235	800.858	1.500	233
800.206	4.800	97	800.319	6.460	289	800.404	0.050	338	800.685	0.500	235	800.860	1.700	233
800.207	3.740	97	800.320	7.000	289	800.405	0.050	338	800.687	0.650	245	800.887	1.780	247
800.221	6.320	97	800.321	6.360	287	800.406	0.050	338	800.688	0.650	245	800.888	2.200	247
800.222	6.980	97	800.322	4.000	287	800.407	0.050	338	800.689	0.800	245	800.889	6.000	304
800.223	7.620	97	800.323	7.080	106	800.408	0.050	338	800.691	1.280	301	800.890	3.900	301
800.224	6.020	97	800.325	3.870	104	800.409	0.050	338	800.692	1.250	301	800.891	3.900	301
800.225	7.060	97	800.327	4.480	104	800.410	0.080	338	800.693	1.240	301	800.899	4.800	244
800.226	9.250	97	800.329	3.900	104	800.411	0.080	338	800.695	1.200	244	800.903	3.450	244
800.227	10.300	97	800.330	4.020	104	800.412	0.080	338	800.698	1.600	244	800.904	4.400	244
800.235	7.100	97	800.332	4.800	104	800.413	0.080	338	800.712	1.100	241	800.905	6.400	244
800.236	9.240	97	800.335	3.490	104	800.414	0.080	338	800.716	1.200	241	800.906	3.300	244
800.237	3.840	97	800.336	4.410	104	800.415	0.080	338	800.717	1.200	241	800.910	5.100	244
800.238	9.700	97	800.338	5.020	104	800.416	0.080	338	800.719	1.200	241	800.911	6.800	244
800.239	11.400	97	800.341	3.460	104	800.417	0.080	338	800.721	1.200	241	800.912	4.900	244
800.240	13.200	97	800.342	3.690	104	800.418	0.080	338	800.722	1.020	241	800.933	2.080	248
800.256	19.000	97	800.343	5.140	104	800.419	0.080	338	800.723	1.700	241	800.934	2.480	248
800.264	3.880	84	800.345	6.220	104	800.420	0.120	339	800.734	0.770	239	800.935	2.020	248
800.265	4.400	84	800.347	3.580	104	800.421	0.120	339	800.735	1.400	239	800.940	2.840	247
800.266	4.500	84	800.348	3.840	104	800.422	0.120	339	800.736	1.000	239	800.942	3.280	247
800.267	4.700	84	800.349	6.420	104	800.423	0.120	339	800.743	0.620	230	800.945	0.060	568
800.268	3.900	84	800.350	4.020	90	800.424	0.120	339	800.746	0.640	230	800.949	6.800	260
800.269	4.400	84	800.351	4.060	90	800.425	0.120	339	800.765	0.830	248	800.950	0.003	561

List with Order Numbers and Weights

Order No.	Weight (kg)	Page	Order No.	Weight (kg)	Page	Order No.	Weight (kg)	Page	Order No.	Weight (kg)	Page	Order No.	Weight (kg)	Page
800.951	0.002	553	801.165	2.600	200	801.270	1.000	188	801.435	0.940	361	801.497	0.280	357
800.952	0.010	553	801.166	2.800	200	801.280	0.020	228	801.436	1.120	361	801.498	0.360	357
800.953	0.040	553	801.167	3.200	200	801.282	1.000	224	801.437	0.520	361	801.499	0.110	357
800.972	1.960	136	801.168	3.900	200	801.283	1.080	224	801.438	0.790	361	801.500	0.170	357
800.973	2.000	136	801.169	1.010	585	801.284	1.180	224	801.439	0.910	361	801.501	0.001	504
800.974	2.010	136	801.172	0.700	186	801.285	1.480	224	801.440	1.100	361	801.507	0.060	374
800.975	1.820	136	801.173	0.800	186	801.286	0.801	224	801.441	0.500	361	801.509	0.220	375
800.976	2.100	136	801.174	0.900	186	801.287	0.770	224	801.442	0.760	361	801.517	0.200	375
800.977	2.780	136	801.175	0.900	186	801.288	0.887	224	801.443	0.920	361	801.524	0.070	336
801.013	0.130	343	801.176	1.500	186	801.289	3.180	295	801.444	1.080	361	801.525	0.070	336
801.037	0.190	352	801.177	0.700	186	801.290	3.180	295	801.445	0.490	361	801.526	0.070	336
801.038	0.290	352	801.178	0.700	186	801.294	2.700	294	801.446	0.750	361	801.527	0.070	336
801.039	0.360	352	801.179	0.800	167	801.296	3.160	294	801.447	0.880	361	801.528	0.070	336
801.040	3.100	159	801.180	2.490	585	801.297	3.860	294	801.448	1.040	361	801.529	0.100	336
801.042	1.600	582	801.188	2.380	194	801.298	0.840	296	801.449	0.480	361	801.530	0.100	336
801.043	4.220	582	801.189	1.190	194	801.299	3.120	293	801.450	0.730	361	801.531	0.100	336
801.045	0.001	366	801.195	1.600	186	801.300	4.080	293	801.451	0.001	504	801.532	0.100	336
801.046	0.002	568	801.196	1.020	186	801.301	1.200	293	801.452	0.930	361	801.533	0.100	336
801.047	0.003	568	801.197	1.400	186	801.302	1.760	292	801.453	1.120	361	801.534	0.100	336
801.071	0.020	228	801.200	1.600	186	801.303	1.100	292	801.454	0.510	361	801.535	0.140	337
801.072	3.840	585	801.201	1.060	186	801.313	0.040	340	801.455	0.780	361	801.536	0.160	337
801.073	5.430	585	801.202	1.400	186	801.314	0.030	340	801.456	0.920	361	801.537	0.160	337
801.091	5.400	194	801.205	1.320	186	801.315	0.050	340	801.457	1.080	361	801.538	0.150	337
801.092	3.880	194	801.206	1.700	186	801.316	0.060	340	801.458	0.500	361	801.539	0.150	337
801.093	4.840	194	801.207	1.200	186	801.317	0.020	340	801.459	0.750	361	801.540	0.150	337
801.094	5.920	194	801.208	1.500	186	801.318	0.150	346	801.460	0.530	361	801.541	0.150	337
801.095	7.200	194	801.211	1.600	186	801.393	0.001	340	801.461	0.820	361	801.542	0.150	337
801.096	2.900	194	801.212	1.300	186	801.394	0.001	340	801.462	0.510	361	801.543	0.150	337
801.101	4.860	194	801.213	1.600	186	801.395	0.001	334	801.463	0.780	361	801.544	0.150	337
801.102	2.920	194	801.214	2.000	186	801.396	0.010	340	801.464	0.020	365	801.545	0.170	337
801.103	3.590	194	801.215	1.160	186	801.397	0.010	340	801.465	1.180	363	801.546	0.170	337
801.104	6.800	194	801.216	2.000	186	801.398	0.001	334	801.466	1.220	363	801.547	0.170	337
801.105	3.300	194	801.217	1.180	186	801.405	0.340	359	801.467	1.340	363	801.548	0.170	337
801.106	4.360	194	801.218	2.100	186	801.406	0.460	359	801.468	1.400	363	801.549	0.010	337
801.117	8.500	194	801.219	2.140	186	801.407	0.590	359	801.469	1.560	363	801.550	0.170	337
801.118	3.700	194	801.221	1.380	186	801.408	0.270	359	801.470	0.003	504	801.551	0.170	337
801.119	5.280	194	801.222	0.970	186	801.409	0.330	359	801.471	1.300	363	801.552	0.170	337
801.124	6.670	194	801.223	1.300	186	801.410	0.570	359	801.472	1.700	363	801.651	0.020	327
801.125	4.900	194	801.226	1.500	186	801.411	0.260	359	801.473	1.500	363	801.652	0.020	327
801.126	2.550	187	801.227	1.000	186	801.412	0.360	359	801.474	0.050	364	801.653	2.200	304
801.127	3.100	187	801.228	1.300	186	801.413	0.460	359	801.475	0.020	365	801.654	0.020	330
801.128	2.500	187	801.248	1.000	200	801.414	0.580	359	801.476	0.020	365	801.655	0.020	327
801.129	2.580	187	801.249	1.200	200	801.415	0.280	359	801.477	0.020	365	801.656	0.020	327
801.130	3.100	187	801.250	1.600	200	801.416	0.340	359	801.478	0.050	364	801.657	0.490	302
801.131	2.500	187	801.251	2.400	200	801.417	0.460	359	801.479	0.220	357	801.658	0.030	330
801.132	2.600	187	801.252	1.200	190	801.418	0.600	359	801.480	0.310	357	801.659	0.020	327
801.133	2.840	187	801.253	0.920	189	801.419	0.270	359	801.481	0.170	357	801.660	0.020	327
801.134	3.300	187	801.254	1.200	189	801.420	0.001	504	801.482	0.220	357	801.662	0.030	330
801.135	2.700	187	801.255	1.300	190	801.421	0.360	359	801.483	0.290	357	801.663	2.600	305
801.136	2.940	187	801.256	1.000	189	801.422	0.480	359	801.484	0.110	357	801.664	4.100	304
801.137	3.600	187	801.257	1.200	189	801.423	0.600	359	801.485	0.170	357	801.665	8.700	304
801.138	3.300	187	801.258	1.220	190	801.424	0.180	359	801.486	0.210	357	801.668	0.781	224
801.139	3.520	187	801.259	1.900	190	801.425	0.270	359	801.487	0.300	357	801.670	3.574	372
801.140	2.600	187	801.260	1.040	190	801.426	0.340	359	801.488	0.360	357	801.671	0.005	328
801.141	3.000	187	801.262	0.900	190	801.427	0.460	359	801.489	0.110	357	801.672	0.040	328
801.142	2.400	187	801.263	1.100	190	801.428	0.570	359	801.490	0.170	357	801.673	1.044	587
801.143	2.550	187	801.264	0.900	189	801.429	0.180	359	801.491	0.210	357	801.674	0.050	330
801.144	3.000	187	801.265	0.950	189	801.430	0.270	359	801.492	0.280	357	801.675	0.005	328
801.145	2.400	187	801.266	1.120	190	801.431	0.960	361	801.493	0.360	357	801.676	0.040	328
801.146	2.380	169	801.267	0.870	189	801.432	1.140	361	801.494	0.110	357	801.677	0.860	224
801.147	2.460	169	801.268	1.020	189	801.433	0.530	361	801.495	0.170	357	801.678	0.050	330
801.164	7.950	201	801.269	1.000	188	801.434	0.820	361	801.496	0.210	357	801.679	0.040	328

List with Order Numbers and Weights

Order No.	Weight (kg)	Page	Order No.	Weight (kg)	Page	Order No.	Weight (kg)	Page	Order No.	Weight (kg)	Page	Order No.	Weight (kg)	Page
801.680	0.040	328	801.761	3.900	584	802.134	0.010	553	802.224	1.040	551	802.427	5.900	213
801.681	4.000	161	801.762	3.780	584	802.135	0.080	553	802.225	1.110	536	802.428	8.400	214
801.682	0.050	330	801.763	5.520	584	802.136	0.100	553	802.226	1.040	536	802.429	8.400	215
801.684	2.100	542	801.764	0.660	348	802.137	0.430	553	802.238	0.550	270	802.430	4.900	213
801.685	0.120	347	801.765	0.660	348	802.138	0.430	553	802.239	0.760	270	802.431	4.800	214
801.688	1.000	174	801.767	0.640	348	802.152	0.120	310	802.241	1.240	270	802.432	4.800	215
801.690	0.020	228	801.768	0.620	348	802.153	0.060	310	802.245	0.580	270	802.433	3.800	214
801.694	0.080	328	801.769	0.600	348	802.154	0.070	310	802.246	0.850	270	802.434	3.800	215
801.695	0.070	328	801.770	0.480	348	802.155	0.110	310	802.247	1.270	270	802.435	0.880	119
801.696	0.005	503	801.771	0.460	348	802.156	0.070	310	802.248	0.590	270	802.436	1.000	119
801.697	0.070	328	801.772	0.360	348	802.157	0.130	310	802.249	0.850	270	802.437	0.000	207
801.698	0.070	328	801.773	0.340	348	802.158	0.110	310	802.250	1.300	270	802.438	0.000	207
801.699	0.030	503	801.774	0.660	348	802.159	0.180	310	802.251	2.680	551	802.440	0.000	207
801.700	0.070	328	801.775	0.660	348	802.160	0.190	310	802.307	6.670	367	802.441	0.000	207
801.701	0.070	328	801.785	0.030	374	802.161	0.250	310	802.308	7.100	367	802.442	0.700	207
801.702	0.010	325	801.787	0.030	374	802.162	0.100	310	802.313	0.800	576	802.449	5.500	109
801.703	0.010	325	801.807	0.070	374	802.163	0.170	310	802.314	0.050	228	802.451	5.900	109
801.704	0.010	325	801.808	0.070	374	802.164	0.100	310	802.315	0.100	228	802.453	6.200	109
801.705	0.100	351	801.810	0.070	374	802.165	0.180	310	802.316	0.190	228	802.455	5.500	109
801.709	0.004	325	801.812	0.070	374	802.166	0.380	311	802.318	22.800	120	802.457	5.900	109
801.711	1.480	66	801.813	0.070	374	802.167	0.270	311	802.329	1.590	377	802.459	6.300	109
801.712	1.480	68	801.814	0.070	374	802.168	0.390	311	802.330	0.010	366	802.462	8.000	109
801.713	2.320	68	801.831	0.070	374	802.169	0.280	311	802.336	1.430	100	802.463	5.100	109
801.714	0.100	313	801.832	0.070	374	802.170	0.500	311	802.337	0.020	354	802.465	5.300	109
801.718	0.100	329	801.833	0.070	374	802.171	0.400	311	802.338	1.000	225	802.467	5.500	109
801.719	0.100	329	801.834	0.070	374	802.172	0.350	311	802.350	1.000	105	802.469	5.700	109
801.720	1.080	58	801.860	0.250	375	802.173	0.300	311	802.351	0.060	228	802.471	4.500	115
801.721	0.120	330	801.861	0.260	375	802.174	0.400	311	802.355	0.330	164	802.472	5.500	115
801.722	0.100	329	801.868	0.260	375	802.175	0.270	311	802.356	0.350	164	802.473	5.600	116
801.723	0.100	329	801.873	0.260	375	802.176	0.560	311	802.357	0.360	164	802.474	5.700	116
801.724	0.860	164	801.876	0.240	375	802.177	0.820	311	802.383	0.020	354	802.475	5.800	116
801.725	0.120	330	801.883	0.270	375	802.178	0.540	311	802.384	0.020	354	802.476	5.700	116
801.726	0.100	329	801.885	0.260	375	802.179	0.790	311	802.385	0.020	354	802.477	5.900	116
801.727	0.100	329	801.889	0.260	375	802.180	0.500	311	802.386	0.020	354	802.478	6.100	116
801.729	0.120	330	801.898	0.280	375	802.181	0.760	311	802.387	0.020	354	802.480	9.700	120
801.730	2.100	66	801.925	0.250	375	802.183	0.640	333	802.388	0.020	354	802.481	6.900	121
801.731	1.640	66	801.927	0.260	375	802.184	1.145	333	802.389	0.020	354	802.482	6.000	113
801.732	3.000	66	801.929	0.260	375	802.185	2.250	333	802.390	0.020	354	802.489	17.400	118
801.733	0.120	330	801.930	0.250	375	802.187	0.310	333	802.391	0.020	354	802.490	17.100	118
801.734	1.400	172	801.931	0.250	375	802.188	0.003	333	802.392	0.020	354	802.492	17.800	117
801.736	2.300	172	801.938	0.240	375	802.189	0.070	269	802.393	0.020	354	802.493	19.000	117
801.737	1.420	172	801.942	0.280	375	802.190	0.070	269	802.394	0.020	354	802.494	13.000	110
801.738	0.004	327	801.944	0.260	375	802.191	0.160	536	802.395	3.350	124	802.497	13.400	110
801.739	2.100	172	801.948	0.260	375	802.192	0.400	536	802.396	2.700	125	802.500	13.700	110
801.740	1.940	174	801.982	0.590	347	802.193	0.290	536	802.398	5.000	124	802.503	13.100	110
801.742	0.010	325	801.983	0.560	347	802.197	0.200	269	802.399	5.500	125	802.506	13.500	110
801.743	0.004	325	801.984	0.480	347	802.198	0.350	269	802.403	4.100	123	802.509	13.800	110
801.744	0.010	327	801.985	0.350	347	802.199	0.400	269	802.404	4.370	124	802.512	14.660	110
801.746	0.010	325	802.001	0.030	374	802.200	0.230	269	802.405	4.000	125	802.515	12.600	110
801.747	0.220	348	802.023	0.070	374	802.201	0.320	269	802.409	3.100	123	802.518	12.800	110
801.748	0.210	348	802.046	0.260	375	802.202	0.410	269	802.411	9.700	124	802.521	13.000	110
801.750	0.010	327	802.063	0.280	348	802.205	0.240	269	802.412	5.000	125	802.524	13.200	110
801.751	0.090	327	802.064	0.250	348	802.209	0.200	269	802.415	7.300	123	802.527	7.600	115
801.752	0.190	348	802.065	0.240	348	802.210	0.280	269	802.416	8.700	124	802.528	8.600	115
801.753	0.003	553	802.066	0.230	348	802.212	0.370	269	802.417	8.700	125	802.529	12.500	116
801.754	0.010	553	802.067	0.220	348	802.217	0.250	269	802.420	3.100	123	802.531	12.600	116
801.755	0.050	553	802.112	0.050	374	802.218	0.300	269	802.421	9.700	161	802.533	12.700	116
801.756	0.261	352	802.120	0.190	375	802.219	0.400	269	802.422	6.800	159	802.535	12.600	116
801.757	0.398	352	802.129	0.500	284	802.220	0.580	536	802.423	8.700	161	802.537	12.800	116
801.758	0.193	352	802.130	0.500	284	802.221	0.520	536	802.424	5.800	159	802.539	13.000	116
801.759	1.000	584	802.131	0.030	286	802.222	0.003	578	802.425	9.400	214	802.544	16.100	121
801.760	2.500	584	802.133	0.020	286	802.223	0.003	578	802.426	9.400	215	802.545	9.200	113

List with Order Numbers and Weights

Order No.	Weight (kg)	Page	Order No.	Weight (kg)	Page	Order No.	Weight (kg)	Page	Order No.	Weight (kg)	Page	Order No.	Weight (kg)	Page
802.546	5.500	153	802.719	5.200	203	802.824	0.150	228	803.073	1.060	184	803.157	4.100	66
802.547	5.900	153	802.721	5.400	203	802.825	0.090	228	803.074	1.100	184	803.158	3.200	66
802.548	6.200	153	802.723	5.600	203	802.827	0.030	228	803.075	1.640	132	803.159	3.700	66
802.549	5.800	153	802.727	5.500	207	802.828	0.040	228	803.076	2.100	132	803.160	3.850	68
802.550	6.000	153	802.728	5.600	207	802.830	2.500	585	803.077	2.080	132	803.161	3.220	68
802.551	6.300	153	802.729	5.700	207	802.831	0.491	585	803.078	2.120	132	803.162	2.600	68
802.552	8.000	153	802.730	5.600	207	802.832	4.100	585	803.079	2.600	172	803.163	3.740	68
802.553	5.100	153	802.731	5.800	207	802.833	5.180	584	803.080	2.020	172	803.166	3.000	237
802.554	5.300	153	802.732	6.000	207	802.834	4.150	584	803.081	2.040	174	803.167	2.900	237
802.555	5.500	153	802.733	0.000	207	802.835	2.670	584	803.082	2.040	226	803.177	1.940	237
802.556	5.700	153	802.734	9.600	211	802.836	0.010	342	803.083	1.960	227	803.179	1.700	237
802.557	9.700	158	802.735	6.800	212	802.837	0.010	342	803.084	1.500	172	803.183	1.340	237
802.558	15.000	156	802.736	5.900	206	802.838	0.010	342	803.085	1.000	172	803.184	1.990	237
802.559	16.300	156	802.740	0.780	119	802.839	0.010	342	803.086	1.300	172	803.185	1.420	237
802.560	16.800	155	802.741	0.780	119	802.840	0.010	342	803.087	1.800	172	803.186	4.500	66
802.561	18.100	155	802.742	1.200	119	802.841	0.010	342	803.088	0.970	174	803.187	4.500	68
802.562	13.000	154	802.750	0.100	570	802.842	0.010	342	803.089	1.240	174	803.188	4.100	66
802.563	13.400	154	802.751	0.110	570	802.843	0.010	342	803.090	1.440	174	803.189	3.920	68
802.564	13.570	154	802.752	0.090	570	802.844	0.010	342	803.092	1.200	226	803.195	2.400	237
802.565	13.100	154	802.753	0.100	570	802.845	0.010	342	803.093	1.400	226	803.196	3.300	66
802.566	13.500	154	802.754	0.200	570	802.846	0.010	342	803.095	1.240	227	803.197	2.300	66
802.567	13.800	154	802.755	0.220	570	802.847	0.010	342	803.096	1.800	227	803.198	2.320	66
802.568	14.200	154	802.756	0.130	568	802.848	0.010	342	803.097	2.800	172	803.199	2.060	66
802.569	12.600	154	802.757	0.020	355	802.942	2.270	369	803.098	3.000	172	803.200	3.180	68
802.570	12.800	154	802.758	0.020	355	802.943	1.330	369	803.099	2.800	172	803.201	2.340	68
802.571	13.000	154	802.759	0.030	355	802.944	0.800	369	803.100	2.800	172	803.202	2.060	68
802.572	13.200	154	802.760	0.030	355	802.945	0.600	369	803.101	1.840	172	803.206	1.680	237
802.573	20.800	158	802.761	0.050	355	802.946	2.500	369	803.102	1.840	174	803.207	0.962	225
802.639	14.200	208	802.762	0.050	355	802.947	1.800	369	803.103	1.840	226	803.208	1.100	225
802.640	15.500	208	802.767	0.020	355	802.948	1.400	369	803.104	2.000	227	803.209	1.260	225
802.642	16.000	210	802.768	0.030	355	802.949	1.200	369	803.105	0.690	172	803.210	1.080	225
802.643	16.600	210	802.769	0.050	355	802.950	0.900	369	803.106	0.750	174	803.211	1.250	225
802.645	12.200	204	802.777	0.441	372	802.963	1.080	525	803.108	1.100	237	803.212	1.500	225
802.648	12.600	204	802.778	1.170	372	803.041	1.700	239	803.112	2.520	237	803.213	1.600	225
802.651	12.900	204	802.781	0.020	370	803.042	1.020	239	803.113	2.000	237	803.214	0.770	225
802.654	12.300	204	802.782	0.030	370	803.043	1.200	239	803.114	1.640	237	803.215	0.906	225
802.657	12.700	204	802.783	0.040	370	803.044	0.500	186	803.115	2.700	66	803.216	1.900	225
802.660	13.000	204	802.785	1.910	373	803.046	0.500	186	803.116	2.060	66	803.217	1.650	225
802.663	13.400	204	802.787	0.070	373	803.048	0.500	186	803.117	2.620	68	803.218	0.800	225
802.664	14.700	204	802.788	0.070	371	803.050	0.600	186	803.118	2.060	68	803.220	1.100	170
802.666	11.800	204	802.789	0.070	371	803.051	0.670	78	803.119	1.640	68	803.221	0.595	170
802.669	12.000	204	802.790	0.070	371	803.052	0.680	78	803.121	3.400	237	803.222	0.650	170
802.672	12.200	204	802.791	0.070	371	803.053	0.480	78	803.125	1.700	237	803.554	0.080	313
802.675	12.400	204	802.792	0.070	371	803.054	0.620	78	803.128	2.240	237	803.555	0.080	313
802.680	11.700	207	802.793	0.070	371	803.055	0.640	78	803.129	2.020	237	803.556	0.100	313
802.682	11.800	207	802.794	0.070	371	803.056	1.320	78	803.130	2.600	66	803.557	0.170	313
802.684	11.900	207	802.795	0.070	371	803.057	1.640	78	803.131	2.360	66	803.558	0.130	313
802.686	11.800	207	802.796	0.070	371	803.058	1.360	78	803.132	2.630	68	803.559	0.200	313
802.688	12.000	207	802.797	0.070	371	803.059	1.700	78	803.133	2.360	68	803.560	0.110	313
802.690	12.200	207	802.798	0.070	371	803.060	1.050	78	803.134	3.700	66	803.561	0.180	313
802.693	0.000	207	802.799	0.070	371	803.061	1.140	78	803.135	3.050	66	803.562	0.180	313
802.695	20.000	211	802.800	0.070	371	803.062	1.240	78	803.136	3.700	68	803.563	0.330	313
802.696	15.300	212	802.801	0.070	371	803.063	1.540	78	803.137	3.060	68	803.564	0.220	313
802.697	5.900	206	802.802	0.070	371	803.064	1.280	78	803.138	4.500	66	803.565	0.300	313
802.702	5.400	203	802.803	0.070	371	803.065	1.600	78	803.139	4.500	68	803.566	0.200	313
802.704	5.800	203	802.805	0.070	370	803.066	4.160	79	803.141	0.800	237	803.567	0.300	313
802.706	6.100	203	802.807	0.070	370	803.067	4.220	79	803.144	1.300	237	803.568	0.200	313
802.708	5.500	203	802.808	0.070	370	803.068	4.020	79	803.145	1.280	237	803.569	0.400	313
802.710	5.900	203	802.809	0.070	370	803.069	4.100	79	803.147	1.320	237	803.570	0.270	313
802.712	6.200	203	802.810	0.070	370	803.070	1.170	184	803.148	1.450	66	803.571	0.250	312
802.716	7.900	203	802.811	0.070	370	803.071	1.160	184	803.149	2.060	68	803.572	0.450	312
802.717	5.000	203	802.812	0.070	370	803.072	0.910	184	803.150	1.480	68	803.573	0.900	312

List with Order Numbers and Weights

Order No.	Weight (kg)	Page	Order No.	Weight (kg)	Page	Order No.	Weight (kg)	Page	Order No.	Weight (kg)	Page	Order No.	Weight (kg)	Page
803.574	1.100	312	803.752	0.020	354	804.168	0.010	325	804.682	0.250	583	804.857	0.040	335
803.575	0.450	312	803.754	0.020	354	804.169	0.010	325	804.683	0.030	583	804.858	0.040	335
803.576	0.850	312	803.755	0.020	354	804.170	0.010	325	804.684	0.030	583	804.860	0.030	335
803.577	0.800	312	803.756	0.040	354	804.171	0.010	325	804.685	0.030	583	804.861	0.036	354
803.578	0.950	312	803.757	0.020	354	804.172	0.010	325	804.686	0.220	583	804.862	0.061	354
803.579	0.680	312	803.758	0.020	354	804.173	0.010	325	804.687	0.030	583	804.863	0.052	354
803.580	1.100	312	803.759	0.020	354	804.174	0.010	325	804.688	0.250	583	804.864	0.078	354
803.581	0.010	344	803.760	0.020	354	804.175	0.010	325	804.690	3.500	77	804.865	0.071	354
803.582	0.050	344	803.761	0.020	354	804.176	0.010	325	804.691	3.800	77	804.866	0.112	354
803.583	0.080	344	803.762	0.020	354	804.177	0.010	325	804.693	2.500	73	804.867	0.108	354
803.584	0.110	344	803.763	0.020	354	804.266	0.000	207	804.697	4.200	73	804.868	0.160	354
803.585	0.150	344	804.108	0.010	326	804.267	0.130	310	804.698	4.400	73	804.869	0.169	354
803.586	0.676	223	804.109	0.020	326	804.268	0.230	310	804.699	4.700	73	804.870	0.320	354
803.587	0.680	223	804.110	0.020	326	804.269	0.140	310	804.700	5.000	73	804.871	0.525	354
803.588	2.000	223	804.111	0.020	326	804.270	0.220	310	804.749	1.260	89	804.872	1.000	354
803.589	0.680	223	804.112	0.020	326	804.271	0.120	310	804.750	1.400	89	804.873	0.010	354
803.590	0.696	223	804.113	0.020	326	804.272	0.220	310	804.751	1.300	89	804.874	0.022	354
803.591	0.710	223	804.114	0.010	326	804.273	0.120	310	804.752	1.300	89	804.875	0.020	354
803.592	0.800	223	804.115	0.260	274	804.274	0.220	310	804.753	4.140	89	804.876	0.032	354
803.593	0.090	314	804.117	0.160	353	804.275	0.420	311	804.754	4.300	89	804.877	5.400	287
803.594	0.110	314	804.119	0.200	353	804.276	0.280	311	804.755	4.100	89	804.878	5.140	287
803.595	0.100	314	804.121	0.300	353	804.277	0.420	311	804.756	4.200	89	804.917	3.820	181
803.596	0.190	264	804.128	1.100	361	804.278	0.290	311	804.757	4.700	103	804.945	0.070	371
803.597	0.472	58	804.129	1.100	361	804.279	0.560	311	804.758	5.100	103	804.949	2.500	583
803.598	0.580	58	804.130	1.000	361	804.280	0.400	311	804.759	5.740	103	804.962	0.940	224
803.599	1.000	59	804.131	1.000	361	804.281	0.380	311	804.760	1.960	103	804.969	3.000	149
803.600	0.900	165	804.132	0.010	325	804.282	0.250	311	804.761	2.360	103	804.970	6.300	98
803.601	1.200	58	804.133	0.012	325	804.283	0.430	311	804.762	2.300	103	804.971	4.500	149
803.602	0.170	314	804.134	0.010	325	804.284	0.290	311	804.763	5.100	103	804.972	4.500	149
803.603	0.980	164	804.135	0.010	325	804.285	0.260	309	804.764	5.700	103	804.973	6.700	98
803.604	0.200	216	804.136	0.010	325	804.286	0.450	309	804.765	6.580	103	804.974	7.800	98
803.608	0.500	59	804.137	0.010	325	804.287	0.750	309	804.771	0.515	352	804.975	4.100	98
803.616	0.900	167	804.138	0.010	325	804.288	0.440	309	804.772	0.020	349	804.976	4.400	196
803.619	1.260	167	804.139	0.010	325	804.289	0.600	309	804.773	0.040	349	804.977	5.500	196
803.620	1.040	167	804.140	0.010	325	804.290	1.230	309	804.783	0.007	366	804.978	5.000	196
803.621	2.300	167	804.141	0.010	325	804.291	0.410	309	804.796	0.002	543	804.979	6.500	196
803.622	0.860	167	804.142	0.010	325	804.292	0.750	309	804.821	0.010	286	804.995	4.130	136
803.623	0.940	167	804.143	0.010	325	804.293	1.200	309	804.825	2.500	108	805.002	8.500	152
803.624	1.360	167	804.144	0.010	325	804.294	0.760	309	804.827	0.090	348	805.016	0.400	128
803.625	0.800	167	804.145	0.010	325	804.295	0.900	309	804.828	0.080	348	805.018	2.700	199
803.626	1.700	167	804.146	0.010	325	804.296	1.400	309	804.829	0.350	348	805.019	2.300	199
803.627	1.200	167	804.147	0.010	325	804.297	0.690	309	804.830	0.340	348	805.035	18.900	111
803.629	0.770	167	804.148	0.010	325	804.298	0.980	309	804.831	0.340	348	805.036	19.100	111
803.631	1.080	224	804.149	0.010	325	804.644	7.500	543	804.832	0.320	348	805.037	19.300	111
803.730	3.550	519	804.150	0.010	325	804.645	7.600	543	804.833	0.310	348	805.038	19.500	111
803.731	5.070	519	804.151	0.010	325	804.646	17.500	543	804.834	0.090	347	805.039	23.300	111
803.736	4.000	105	804.152	0.010	325	804.649	1.330	576	804.835	0.070	347	805.040	23.500	111
803.737	0.500	249	804.153	0.010	325	804.656	1.180	577	804.836	2.600	108	805.041	23.700	111
803.738	2.050	249	804.154	0.010	325	804.658	0.400	577	804.838	2.700	108	805.042	23.900	111
803.739	0.800	249	804.155	0.010	325	804.661	2.300	108	804.844	0.010	335	805.043	27.700	111
803.740	3.600	249	804.156	0.010	325	804.662	0.200	578	804.845	0.010	335	805.044	27.900	111
803.741	0.020	354	804.157	0.010	325	804.666	0.003	366	804.846	0.020	335	805.045	28.100	111
803.742	0.020	354	804.158	0.010	325	804.667	0.003	366	804.847	0.020	335	805.046	28.300	111
803.743	0.020	354	804.159	0.010	325	804.668	0.003	366	804.848	0.040	335	805.047	19.300	111
803.744	0.020	354	804.160	0.010	325	804.669	0.010	366	804.849	0.040	335	805.048	19.700	111
803.745	0.020	354	804.161	0.010	325	804.670	0.010	366	804.850	0.030	335	805.049	20.000	111
803.746	0.020	354	804.162	0.010	325	804.671	0.010	366	804.851	0.020	335	805.050	23.700	111
803.747	0.020	354	804.163	0.010	325	804.672	0.005	366	804.852	0.300	335	805.051	24.100	111
803.748	0.020	354	804.164	0.010	325	804.678	0.660	355	804.853	0.020	335	805.052	24.400	111
803.749	0.020	354	804.165	0.010	325	804.679	0.600	355	804.854	0.050	335	805.053	28.100	111
803.750	0.020	354	804.166	0.010	325	804.680	0.030	583	804.855	0.050	335	805.054	28.500	111
803.751	0.020	354	804.167	0.010	325	804.681	0.030	583	804.856	0.040	335	805.055	28.800	111

List with Order Numbers and Weights

Order No.	Weight (kg)	Page	Order No.	Weight (kg)	Page	Order No.	Weight (kg)	Page	Order No.	Weight (kg)	Page	Order No.	Weight (kg)	Page
805.057	19.400	111	805.173	0.480	360	805.438	6.020	136	805.542	1.000	202	805.662	7.600	175
805.058	19.800	111	805.174	0.180	165	805.442	1.500	583	805.543	0.010	581	805.663	0.067	344
805.060	20.100	111	805.194	0.400	230	805.444	0.650	100	805.544	0.310	375	805.664	0.009	344
805.061	23.800	111	805.201	5.800	199	805.446	0.190	355	805.548	0.800	184	805.665	0.135	344
805.062	24.200	111	805.232	2.400	198	805.449	4.600	70	805.549	1.440	80	805.666	0.180	344
805.063	24.500	111	805.234	1.500	198	805.450	5.720	70	805.550	1.020	82	805.668	0.090	334
805.064	28.200	111	805.235	1.400	198	805.451	5.100	70	805.551	0.980	82	805.669	0.090	334
805.065	28.600	111	805.236	1.400	198	805.452	6.900	70	805.553	0.240	353	805.670	0.090	334
805.066	28.900	111	805.237	2.000	198	805.453	5.400	70	805.560	0.980	267	805.671	0.090	334
805.067	20.500	111	805.238	1.360	362	805.454	7.640	70	805.569	0.860	96	805.672	0.090	334
805.069	24.900	111	805.239	1.594	362	805.455	5.600	70	805.570	1.900	114	805.673	0.090	334
805.070	29.300	111	805.240	0.110	362	805.456	8.420	70	805.571	1.980	114	805.677	1.720	80
805.077	0.500	80	805.241	1.350	362	805.457	3.980	176	805.573	1.340	194	805.678	2.100	80
805.078	0.660	80	805.242	1.540	362	805.458	4.220	176	805.574	1.590	194	805.679	4.900	81
805.079	0.670	80	805.243	1.340	101	805.459	4.760	176	805.575	0.240	264	805.680	5.000	81
805.080	0.700	80	805.244	0.160	348	805.460	0.160	353	805.576	0.700	223	805.684	0.100	228
805.081	0.720	80	805.245	0.130	348	805.461	1.820	527	805.584	1.200	146	805.723	1.080	107
805.082	1.180	80	805.246	0.480	128	805.462	0.620	78	805.585	1.780	146	805.724	0.919	284
805.083	1.150	80	805.247	0.580	129	805.463	1.180	78	805.586	1.500	146	805.728	0.130	355
805.084	1.450	80	805.250	0.490	165	805.464	1.400	78	805.595	0.920	267	805.732	1.200	199
805.085	1.200	80	805.251	0.580	164	805.465	0.940	184	805.596	2.100	132	805.733	0.020	355
805.086	1.500	80	805.252	0.530	167	805.466	1.060	184	805.597	2.100	132	805.734	0.110	355
805.087	1.200	80	805.253	0.610	167	805.467	1.300	184	805.598	2.100	132	805.735	0.100	355
805.088	1.540	80	805.254	0.660	167	805.468	1.300	184	805.600	6.120	132	805.736	0.060	355
805.089	1.240	80	805.255	0.720	167	805.469	1.400	184	805.601	6.300	132	805.737	0.020	355
805.090	1.600	80	805.256	0.650	167	805.470	1.400	184	805.604	2.550	146	805.738	0.020	355
805.091	3.940	81	805.257	0.800	165	805.471	0.180	220	805.605	1.240	146	805.739	0.360	355
805.092	3.960	81	805.258	0.820	165	805.472	0.180	220	805.606	1.980	146	805.740	0.290	355
805.093	4.000	81	805.259	0.790	164	805.473	0.190	220	805.608	2.000	146	805.750	7.440	175
805.094	4.100	81	805.260	0.830	164	805.474	0.290	220	805.609	1.240	146	805.753	5.600	132
805.096	1.120	185	805.261	0.920	164	805.475	0.290	220	805.610	1.240	146	805.758	3.150	147
805.097	1.140	185	805.262	0.860	168	805.476	0.290	220	805.611	2.220	146	805.773	7.650	75
805.098	1.180	185	805.263	0.920	168	805.477	0.900	185	805.623	3.720	147	805.802	0.230	326
805.099	1.300	185	805.264	1.090	168	805.478	1.360	185	805.624	4.320	147	805.808	5.100	133
805.100	0.768	180	805.265	0.980	168	805.479	1.400	185	805.626	1.240	147	805.809	5.400	133
805.101	1.020	180	805.266	1.200	168	805.480	0.820	80	805.627	4.450	147	805.810	5.180	133
805.102	1.780	180	805.267	1.040	168	805.481	0.920	80	805.628	5.440	147	805.811	0.210	571
805.103	2.420	180	805.268	1.320	168	805.482	1.340	80	805.629	6.500	147	805.812	0.210	571
805.104	2.560	180	805.269	1.140	168	805.483	1.760	80	805.630	3.300	147	805.814	0.560	76
805.105	3.240	180	805.270	1.220	168	805.484	1.340	80	805.631	4.150	147	805.815	1.320	76
805.106	2.890	181	805.271	1.710	168	805.485	1.840	80	805.632	5.450	147	805.816	1.560	76
805.107	3.460	181	805.282	2.400	198	805.486	4.240	81	805.633	6.500	147	805.817	3.950	76
805.108	4.020	181	805.283	5.120	542	805.487	4.320	81	805.635	3.600	147	805.818	4.280	76
805.110	3.240	181	805.284	3.240	542	805.489	2.900	367	805.636	5.100	147	805.819	4.600	76
805.111	4.660	181	805.290	4.700	169	805.492	0.020	350	805.637	7.200	147	805.820	0.510	78
805.112	3.700	181	805.296	4.900	148	805.493	0.020	350	805.638	8.920	147	805.821	0.620	78
805.113	4.160	181	805.298	6.200	148	805.494	0.020	350	805.639	4.180	147	805.822	4.520	79
805.114	5.140	181	805.299	7.300	148	805.495	0.020	350	805.640	6.250	147	805.823	4.640	79
805.115	6.160	181	805.305	7.500	295	805.496	0.020	350	805.641	8.450	147	805.824	4.760	79
805.116	9.100	181	805.306	7.400	295	805.497	0.020	350	805.642	12.400	147	805.825	4.860	79
805.117	1.400	181	805.356	0.280	348	805.498	0.020	350	805.643	4.540	147	805.826	1.760	83
805.118	4.650	181	805.397	0.050	588	805.499	0.020	350	805.644	5.860	147	805.827	0.005	370
805.119	5.080	181	805.412	0.430	264	805.527	0.320	184	805.645	7.150	147	805.828	0.520	164
805.151	4.900	199	805.413	0.200	348	805.530	2.100	300	805.646	1.950	194	805.829	1.060	182
805.152	3.400	199	805.423	6.000	583	805.531	1.200	100	805.647	1.170	372	805.830	1.400	182
805.156	0.070	348	805.424	4.040	136	805.532	0.190	355	805.655	4.100	201	805.831	2.100	185
805.157	0.060	348	805.430	3.790	136	805.535	9.300	295	805.656	4.700	201	805.832	2.300	185
805.158	0.050	348	805.431	4.200	136	805.536	9.950	295	805.657	10.100	201	805.833	0.800	194
805.159	0.040	348	805.433	4.720	136	805.537	6.560	294	805.658	6.400	175	805.834	1.000	194
805.168	1.900	100	805.435	4.950	136	805.538	3.450	296	805.659	7.600	175	805.835	0.410	267
805.170	4.400	100	805.436	5.980	136	805.539	3.900	296	805.660	6.840	175	805.836	0.430	267
805.172	1.040	360				805.540	5.070	296	805.661	8.820	175	805.837	0.480	267

List with Order Numbers and Weights

Order No.	Weight (kg)	Page	Order No.	Weight (kg)	Page	Order No.	Weight (kg)	Page	Order No.	Weight (kg)	Page	Order No.	Weight (kg)	Page
805.838	0.520	267	806.013	4.200	84	806.354	1.300	140	806.422	2.300	316	806.657	0.555	333
805.839	0.570	267	806.014	4.500	84	806.355	1.300	140	806.423	4.500	316	806.671	0.340	262
805.840	1.320	267	806.020	0.704	292	806.356	1.300	140	806.424	0.100	316	806.680	1.200	91
805.841	1.280	267	806.021	1.200	296	806.357	1.300	140	806.425	0.100	316	806.681	1.500	91
805.842	0.640	268	806.022	1.500	296	806.358	1.380	140	806.426	0.100	316	806.682	2.100	91
805.843	0.850	268	806.023	1.600	296	806.359	1.380	140	806.427	0.170	316	806.683	4.300	92
805.844	1.080	268	806.024	2.000	296	806.360	3.140	140	806.428	0.170	316	806.684	5.900	92
805.845	1.500	583	806.025	4.900	296	806.361	3.300	140	806.429	0.160	316	806.685	7.000	92
805.846	3.900	583	806.044	3.000	198	806.362	1.700	70	806.430	0.090	220	806.686	8.200	92
805.847	1.300	542	806.045	2.900	198	806.363	2.100	70	806.431	0.090	220	806.687	9.700	92
805.848	1.900	542	806.046	2.900	198	806.364	1.600	176	806.436	0.400	588	806.688	9.900	92
805.849	0.200	536	806.047	3.600	198	806.365	2.100	176	806.437	0.010	588	806.689	12.700	92
805.850	0.320	536	806.048	3.600	198	806.370	1.300	167	806.439	0.100	565	806.690	5.500	93
805.851	0.260	536	806.049	4.200	198	806.371	1.800	168	806.440	0.460	565	806.692	6.100	93
805.852	0.700	536	806.050	1.500	199	806.372	2.200	168	806.441	1.900	140	806.693	8.100	93
805.853	0.600	536	806.051	3.650	199	806.373	4.300	169	806.442	0.140	348	806.694	9.500	93
805.854	1.100	536	806.052	6.700	199	806.374	1.300	169	806.443	0.090	348	806.695	10.300	93
805.855	1.000	536	806.148	0.020	503	806.375	1.800	129	806.444	1.700	186	806.696	12.900	93
805.856	3.300	520	806.164	2.900	77	806.376	2.300	129	806.462	0.190	352	806.697	15.200	93
805.858	0.500	524	806.197	0.020	349	806.377	4.000	130	806.463	0.340	232	806.698	0.400	243
805.859	0.600	524	806.198	0.090	349	806.378	4.600	130	806.465	0.140	349	806.699	0.400	243
805.860	0.500	524	806.243	1.760	296	806.379	0.950	60	806.466	0.050	349	806.700	0.500	243
805.861	0.600	524	806.244	2.280	296	806.380	1.600	62	806.467	0.040	349	806.701	0.500	243
805.862	0.600	524	806.245	3.950	296	806.381	1.900	62	806.468	0.040	349	806.702	0.500	243
805.863	0.700	524	806.246	2.200	294	806.382	2.200	62	806.476	0.090	349	806.703	2.400	243
805.864	0.790	524	806.247	2.640	295	806.383	2.500	62	806.477	0.110	349	806.704	3.000	243
805.865	0.600	524	806.248	2.640	295	806.384	4.300	63	806.478	0.140	349	806.705	2.700	243
805.866	1.000	524	806.249	3.100	295	806.385	4.900	63	806.541	0.260	560	806.706	3.800	243
805.867	0.700	524	806.250	3.100	295	806.386	5.800	63	806.575	5.200	169	806.707	4.800	243
805.868	1.000	524	806.252	5.000	295	806.387	6.240	63	806.579	4.300	98	806.708	5.600	243
805.869	0.001	528	806.253	3.300	305	806.388	0.290	334	806.580	5.000	98	806.709	5.200	75
805.870	0.001	528	806.254	3.300	305	806.389	0.060	335	806.581	4.600	98	806.712	0.460	262
805.871	0.001	528	806.255	4.950	295	806.390	0.200	329	806.582	5.700	98	806.713	0.560	262
805.872	0.001	528	806.256	3.010	305	806.391	0.200	329	806.585	4.000	195	806.714	0.740	262
805.873	0.001	528	806.257	0.001	528	806.392	0.190	329	806.586	4.800	195	806.715	0.650	262
805.874	1.400	292	806.258	0.001	528	806.393	0.190	329	806.587	5.400	195	806.716	0.780	262
805.875	1.840	292	806.259	0.700	73	806.394	0.190	329	806.588	6.700	195	806.717	0.860	262
805.876	3.700	292	806.260	1.400	73	806.395	0.180	329	806.589	5.100	195	806.718	0.970	262
805.877	4.000	292	806.261	1.300	73	806.396	0.180	329	806.590	6.300	195	806.719	1.100	262
805.878	4.200	293	806.262	1.600	73	806.397	0.180	329	806.591	4.800	195	806.720	1.600	262
805.879	6.100	293	806.263	1.900	73	806.398	0.170	329	806.592	7.800	195	806.721	2.200	262
805.880	2.700	296	806.264	2.700	73	806.399	0.170	329	806.593	6.000	195	806.722	2.400	262
805.881	3.200	296	806.265	4.500	73	806.400	0.160	329	806.594	0.086	228	806.723	2.500	262
805.882	0.030	347	806.266	1.200	179	806.401	0.160	329	806.595	1.500	180	806.724	5.100	262
805.883	0.020	347	806.267	1.800	179	806.402	0.150	329	806.601	0.440	103	806.725	0.700	271
805.884	0.020	347	806.268	2.400	179	806.403	0.150	329	806.602	0.440	103	806.726	0.800	271
805.885	0.070	374	806.270	5.200	77	806.404	0.140	329	806.603	0.410	103	806.727	0.900	271
805.886	0.560	375	806.271	5.600	77	806.405	0.140	329	806.604	1.080	103	806.728	1.000	271
805.887	0.590	375	806.272	6.000	77	806.406	0.130	329	806.605	1.100	103	806.729	1.000	271
805.888	0.570	375	806.273	2.900	183	806.407	0.130	329	806.606	1.120	103	806.730	1.100	271
805.889	0.520	375	806.274	3.900	183	806.408	0.120	329	806.607	1.000	151	806.731	1.200	271
805.890	0.900	541	806.284	1.600	91	806.409	0.120	329	806.608	1.000	151	806.732	1.300	271
805.891	0.046	286	806.312	0.170	232	806.412	0.220	332	806.609	1.100	151	806.733	1.800	271
805.892	0.066	286	806.313	0.240	232	806.413	0.220	332	806.622	0.220	567	806.734	0.110	220
805.894	0.800	369	806.328	1.020	91	806.414	0.210	332	806.624	0.047	503	806.737	8.000	369
805.897	0.028	503	806.347	1.160	138	806.415	0.200	332	806.627	6.800	176	806.738	8.000	369
805.909	0.640	352	806.348	1.160	138	806.416	0.190	332	806.628	7.200	176	806.739	0.120	332
805.969	0.620	352	806.349	1.200	138	806.417	0.180	332	806.629	7.900	176	806.742	2.300	438
805.970	0.135	352	806.350	1.220	138	806.418	0.170	332	806.630	6.900	196	806.743	4.400	438
805.971	0.189	352	806.351	1.240	138	806.419	0.150	332	806.631	8.000	196	806.744	8.300	438
806.011	1.200	83	806.352	1.300	140	806.420	0.140	332	806.636	0.550	216	806.747	1.000	128
806.012	1.800	83	806.353	1.300	140	806.421	0.130	332	806.656	3.700	333	806.795	10.500	367

List with Order Numbers and Weights

Order No.	Weight (kg)	Page	Order No.	Weight (kg)	Page	Order No.	Weight (kg)	Page	Order No.	Weight (kg)	Page	Order No.	Weight (kg)	Page
806.800	0.230	166	806.994	0.260	318	807.200	1.200	102	807.437	0.750	240	807.578	0.240	349
806.802	0.100	316	806.995	0.250	318	807.201	1.300	102	807.438	0.780	240	807.579	0.210	349
806.803	0.100	316	806.996	0.240	318	807.202	1.400	102	807.439	1.100	240	807.580	0.500	78
806.804A	0.170	164	806.997	0.050	588	807.203	1.100	139	807.440	1.100	240	807.582	0.600	78
806.805	1.270	587	807.003	14.100	75	807.204	1.100	139	807.441	1.300	240	807.583	1.200	78
806.806	0.600	586	807.015	0.690	567	807.205	1.200	139	807.442	1.100	240	807.584	4.500	79
806.807	1.300	586	807.016	1.200	438	807.206	1.200	139	807.443	1.300	240	807.585	0.700	353
806.808	2.700	586	807.017	0.001	431	807.207	1.200	139	807.444	1.100	240	807.586	0.700	352
806.810	1.400	137	807.018	0.001	431	807.208	1.400	146	807.445	1.300	240	807.640	0.200	303
806.811	1.600	137	807.019	0.020	431	807.209	3.400	147	807.446	1.200	240	807.641	0.200	303
806.812	3.500	137	807.020	0.020	431	807.210	5.600	147	807.447	1.300	240	807.642	0.200	303
806.813	3.800	137	807.041	0.010	503	807.211	0.280	358	807.455	0.200	526	807.643	0.200	303
806.830	2.800	188	807.071	6.500	92	807.212	0.490	358	807.456	0.400	526	807.644	0.160	303
806.831	2.900	188	807.088	0.900	220	807.213	0.610	358	807.457	0.300	526	807.645	0.160	303
806.832	3.000	188	807.089	0.920	220	807.214	0.760	358	807.458	0.600	526	807.646	0.610	304
806.833	3.020	188	807.090	0.920	220	807.215	0.010	228	807.459	0.600	526	807.647	0.610	304
806.834	3.300	188	807.091	0.930	220	807.216	0.010	228	807.460	1.220	526	807.648	0.600	305
806.835	4.000	188	807.092	5.900	176	807.220	0.180	318	807.461	1.220	526	807.649	0.600	305
806.836	3.400	188	807.102	0.012	354	807.221	0.220	318	807.473	1.560	375	807.650	0.006	286
806.837	4.200	188	807.103	0.013	354	807.222	0.220	318	807.474	0.550	375	807.651	0.005	286
806.840	0.001	334	807.104	0.015	354	807.223	0.220	318	807.488	0.310	318	807.663	0.170	306
806.862	0.020	326	807.105	0.163	354	807.224	0.210	318	807.489	0.310	318	807.664	0.170	306
806.863	0.020	326	807.106	0.250	354	807.225	0.260	318	807.490	0.310	318	807.665	0.200	306
806.864	0.020	326	807.107	0.300	354	807.226	0.001	561	807.491	0.310	318	807.666	0.250	306
806.865	0.020	326	807.108	0.450	354	807.227	4.100	199	807.492	0.310	318	807.667	0.150	230
806.866	0.020	326	807.109	0.510	354	807.228	4.400	199	807.493	0.290	318	807.669	0.210	232
806.896	1.100	146	807.114	6.900	194	807.229	5.660	199	807.497	0.280	318	807.671	0.270	232
806.902	1.200	91	807.115	0.900	220	807.230	8.100	199	807.498	0.370	318	807.673	8.100	149
806.907	0.090	221	807.120	0.110	221	807.231	8.500	199	807.499	0.370	318	807.674	5.300	98
806.908	0.090	221	807.123	0.310	221	807.232	4.200	79	807.500	0.370	318	807.675	7.000	98
806.909	0.190	221	807.125	0.310	221	807.252	0.330	220	807.501	0.370	318	807.676	8.800	98
806.910	0.190	221	807.126	0.320	221	807.253	0.380	220	807.502	0.350	318	807.677	10.500	98
806.911	0.200	221	807.130	6.200	194	807.255	0.900	351	807.503	0.330	318	807.678	8.500	148
806.912	0.050	588	807.131	0.003	537	807.319	1.400	199	807.504	0.240	319	807.679	10.200	148
806.921	2.400	329	807.132	0.003	537	807.321	0.900	199	807.505	0.240	319	807.680	7.700	196
806.922	4.500	385	807.133	0.003	537	807.322	1.000	199	807.506	0.220	319	807.681	9.500	196
806.923	8.300	385	807.134	0.006	537	807.323	1.100	199	807.507	0.210	319	807.685	0.050	567
806.924	1.600	91	807.135	0.003	537	807.361	1.300	103	807.512	0.240	319	807.686	0.100	567
806.950	0.450	303	807.136	0.003	537	807.362	1.400	103	807.513	0.240	319	807.697	0.020	503
806.951	0.450	303	807.137	0.003	537	807.363	1.500	103	807.514	0.220	319	807.710	0.160	314
806.952	0.420	303	807.138	0.006	537	807.364	1.200	151	807.515	0.210	319	807.711	0.500	580
806.953	0.420	303	807.139	0.006	567	807.365	1.300	151	807.516	0.280	319	807.713	0.200	579
806.954	0.400	303	807.150	1.100	91	807.366	1.400	151	807.517	0.280	319	807.714	0.200	579
806.955	0.400	303	807.158	0.006	567	807.372	0.600	80	807.518	0.260	319	807.715	0.200	579
806.956	0.960	304	807.165	0.002	581	807.373	1.000	184	807.519	0.250	319	807.718	0.055	580
806.957	0.960	304	807.168	0.370	220	807.374	1.100	184	807.520	0.220	319	807.771	0.960	351
806.958	0.840	305	807.183	6.700	92	807.400	0.300	438	807.521	0.340	320	807.788	1.100	184
806.959	0.840	305	807.184	1.000	91	807.401	0.600	438	807.522	0.330	320	869.001	4.000	92
806.960	0.320	306	807.185	8.800	438	807.403	8.900	316	807.523	0.360	320	869.002	4.000	92
806.961	0.330	306	807.186	16.400	438	807.404	0.100	317	807.524	0.360	320	869.003	3.800	92
806.962	0.340	306	807.187	0.001	561	807.405	0.100	317	807.525	0.350	320	869.004	3.900	92
806.963	0.400	306	807.188	0.003	561	807.406	0.100	316	807.540	0.240	272	869.005	4.300	92
806.964	0.480	306	807.189	0.010	228	807.407	0.160	317	807.541	0.260	272	869.007	4.800	92
806.965	0.710	306	807.190	0.010	228	807.408	0.160	317	807.546	4.300	193	869.008	2.300	91
806.966	0.070	559	807.192	0.030	555	807.409	0.160	316	807.547	5.700	94	869.011	4.000	92
806.967	0.070	559	807.193	0.030	555	807.410	0.100	314	807.552	0.360	272	869.012	5.100	92
806.968	0.150	559	807.194	0.030	558	807.411	0.100	314	807.553	0.540	272	869.013	4.500	92
806.969	0.200	559	807.195	0.030	558	807.412	0.110	314	807.554	0.025	286	869.014	4.700	92
806.970	0.260	559	807.196	0.030	557	807.413	0.180	314	807.556	0.010	286	869.015	4.900	92
806.991	0.180	318	807.197	0.020	364	807.434	0.720	240	807.572	0.760	258	869.017	1.100	91
806.992	0.180	318	807.198	0.030	364	807.435	0.710	240	807.576	4.600	296	869.018	12.000	93
806.993	0.170	318	807.199	0.060	364	807.436	0.720	240	807.577	4.600	296	869.019	0.000	243

List with Order Numbers and Weights

Order No.	Weight (kg)	Page	Order No.	Weight (kg)	Page	Order No.	Weight (kg)	Page	Order No.	Weight (kg)	Page	Order No.	Weight (kg)	Page
869.024	4.900	192	958.061	0.002	573	961.155	0.010	330	961.295	2.040	368	961.497	0.003	325
869.025	7.500	192	958.062	0.002	573	961.156	0.004	330	961.296	3.380	368	961.498	0.300	326
938.834	0.001	471	958.063	0.002	573	961.160	0.020	330	961.297	4.500	368	961.500	0.005	327
938.835	0.004	490	958.065	0.002	573	961.161	0.020	330	961.331	0.270	375	961.501	0.004	327
938.837	0.001	488	958.066	0.002	573	961.165	0.050	330	961.332	0.260	375	961.502	0.005	327
938.840	0.001	488	958.067	0.002	573	961.166	0.040	330	961.333	0.240	375	961.503	0.005	327
938.841	0.001	471	958.071	0.002	573	961.167	0.030	330	961.336	0.240	375	961.504	0.004	327
938.862	0.010	491	958.072	0.002	573	961.168	0.090	330	961.338	2.600	367	961.505	0.005	327
938.866	0.001	490	958.073	0.002	573	961.169	0.080	330	961.339	2.900	367	961.506	0.005	327
938.867	0.001	490	958.075	0.002	573	961.170	0.080	330	961.342	2.950	367	961.507	0.004	327
938.868	0.004	490	958.076	0.002	573	961.171	0.080	330	961.346	2.600	367	961.508	0.005	327
938.869	0.004	490	958.077	0.002	573	961.172	0.080	330	961.347N	1.200	581	961.509	0.003	327
938.870	0.010	491	958.081	0.002	573	961.173	0.080	330	961.362	1.360	102	961.510	0.004	327
938.871	0.010	491	958.082	0.002	573	961.174	0.070	330	961.363	1.480	102	961.511	0.003	327
938.876	0.002	471	958.083	0.002	573	961.175	0.060	330	961.364	1.550	102	961.512	0.004	327
938.879	0.001	488	958.085	0.002	573	961.176	0.050	330	961.365	2.160	102	961.513	0.003	327
938.883	0.001	487	958.086	0.002	573	961.180	0.120	330	961.366	2.740	102	961.514	0.004	327
938.884	0.001	487	958.087	0.002	573	961.182	0.110	330	961.367	4.080	102	961.515	0.003	327
938.885	0.001	487	958.091	0.010	573	961.183	0.100	330	961.368	4.160	102	961.516	0.003	327
948.101	0.001	487	958.092	0.010	573	961.184	0.090	330	961.369	4.860	102	961.517	0.003	327
948.201	0.001	488	958.093	0.010	573	961.185	0.090	330	961.371	6.180	97	961.518	0.003	327
948.202	0.002	488	958.095	0.010	495	961.186	0.050	330	961.372	8.040	97	961.519	0.003	327
948.203	0.002	488	958.096	0.010	573	961.200	0.002	578	961.394	0.490	102	961.520	0.003	327
948.210	0.010	488	958.097	0.010	573	961.202	0.002	581	961.395	0.520	102	961.521	0.003	327
948.211	0.010	488	958.155	0.012	495	961.205	0.265	578	961.396	0.610	102	961.522	0.003	327
948.230	0.010	488	958.156	0.013	495	961.206	0.265	578	961.397	0.700	102	961.524	0.310	333
948.231	0.010	488	958.157	0.002	495	961.207	0.010	581	961.401	0.030	336	961.525	0.020	352
948.251A	0.001	488	958.158	0.003	495	961.210	0.002	581	961.402	0.030	336	961.526	0.010	334
948.252	0.001	488	958.313	0.002	495	961.214	0.030	581	961.403	0.030	336	961.527	0.003	335
948.253	0.001	488	958.314	0.002	495	961.237	0.440	576	961.404	0.050	336	961.531	0.010	327
948.270	0.001	488	958.425	0.004	444	961.238	0.400	577	961.405	0.040	336	961.532	0.010	327
948.271	0.001	488	958.430	0.004	444	961.252	0.290	373	961.406	0.050	336	961.533	0.010	327
948.301	0.010	471	958.433	0.004	444	961.253	0.380	373	961.407	0.040	336	961.534	0.010	327
948.302	0.001	471	958.435	0.004	444	961.254	0.005	373	961.408	0.050	336	961.535	0.010	327
948.310	0.001	471	958.440	0.004	444	961.255	5.200	373	961.409	0.020	338	961.536	0.010	327
948.311	0.001	471	958.475	0.004	444	961.256	7.000	373	961.410	0.020	338	961.537	0.010	327
948.312	0.001	471	958.480	0.004	444	961.257	9.500	373	961.411	0.020	338	961.538	0.010	327
948.330	0.001	471	958.483	0.004	444	961.264	1.500	584	961.412	0.040	338	961.539	0.010	327
948.331	0.001	471	958.485	0.004	444	961.269	5.890	584	961.413	0.040	338	961.540	0.010	327
948.332	0.001	471	958.490	0.004	444	961.270	2.900	367	961.414	0.040	338	961.541	0.010	327
948.350A	0.001	471	958.501	0.001	415	961.271	2.370	367	961.415	0.040	338	961.542	0.010	327
948.351A	0.001	471	958.502	0.001	415	961.272	6.860	367	961.416	0.040	338	961.543	0.004	327
948.352A	0.001	471	958.503	0.001	415	961.273	5.960	367	961.417	0.100	336	961.544	0.010	327
948.370	0.001	471	958.601	0.020	461	961.276	0.020	371	961.418	0.100	336	961.545	0.005	327
948.371	0.001	471	958.602	0.020	461	961.277	0.020	371	961.420	0.100	336	961.547	0.230	333
948.372	0.001	471	958.603	0.020	461	961.278	0.003	370	961.462	0.003	324	961.548	0.040	352
948.373	0.002	471	958.604	0.020	461	961.279	0.005	370	961.464	0.003	324	961.549	0.020	334
948.374	0.002	471	958.611	0.020	461	961.280	0.005	370	961.466	0.003	324	961.550	0.001	335
948.375	0.001	471	958.612	0.020	461	961.281	0.005	370	961.468	0.003	324	961.551	0.020	327
958.008	0.040	572	958.613	0.020	461	961.282	0.005	370	961.470	0.002	324	961.552	0.020	327
958.010	0.040	572	958.614	0.020	461	961.283	0.009	370	961.472	0.003	324	961.553	0.020	327
958.021	0.080	572	961.120	0.020	327	961.284	0.009	370	961.474	0.002	324	961.554	0.020	327
958.031	0.110	572	961.127	0.040	328	961.285	0.005	370	961.477	0.005	325	961.555	0.020	327
958.041	0.500	572	961.146	0.002	330	961.286	0.005	370	961.479	0.005	325	961.556	0.020	327
958.048	0.010	514	961.147	0.040	330	961.287	0.005	370	961.481	0.005	325	961.557	0.020	327
958.049	0.060	514	961.148	0.004	330	961.288	0.010	370	961.483	0.005	325	961.558	0.020	327
958.051	0.002	573	961.149	0.004	330	961.289	0.010	370	961.485	0.005	325	961.559	0.020	327
958.052	0.002	573	961.150	0.004	330	961.290	0.005	370	961.487	0.005	325	961.560	0.020	327
958.053	0.002	573	961.151	0.002	330	961.291	0.720	368	961.489	0.005	325	961.561	0.020	327
958.055	0.002	573	961.152	0.010	330	961.292	0.880	368	961.491	0.005	325	961.562	0.020	327
958.056	0.002	573	961.153	0.010	330	961.293	1.100	368	961.493	0.004	325	961.563	0.020	327
958.057	0.002	573	961.154	0.010	330	961.294	1.500	368	961.495	0.004	325	961.564	0.020	327

List with Order Numbers and Weights

Order No.	Weight (kg)	Page	Order No.	Weight (kg)	Page	Order No.	Weight (kg)	Page	Order No.	Weight (kg)	Page	Order No.	Weight (kg)	Page
961.565	0.020	327	961.631	0.080	334	961.726	0.540	265	961.945	1.810	71	962.405	0.050	348
961.566	0.020	327	961.632	0.005	335	961.727	0.690	265	961.946	1.100	71	962.406	0.150	348
961.567	0.010	327	961.641	0.100	329	961.728	0.840	265	961.947	1.440	71	962.407	0.100	348
961.569	0.360	333	961.642	0.100	329	961.731	0.580	265	961.948	1.980	71	962.408	0.370	348
961.570	0.040	352	961.643	0.100	329	961.732	0.730	265	961.959	2.310	71	962.409	0.370	348
961.571	0.040	334	961.644	0.100	329	961.733	0.880	265	961.962	3.680	72	962.410	0.370	348
961.572	0.010	335	961.645	0.100	329	961.736	0.769	266	961.963	3.740	72	962.411	0.360	348
961.573	0.040	328	961.646	0.100	329	961.737	0.300	266	961.964	3.820	72	962.412	0.360	348
961.574	0.040	328	961.647	0.100	329	961.741	0.800	266	961.966	3.740	72	962.413	0.350	348
961.575	0.040	328	961.648	0.100	329	961.742	1.055	266	961.967	3.880	72	962.414	0.340	348
961.576	0.040	328	961.649	0.100	329	961.746	0.820	266	961.970	3.840	72	962.415	0.330	348
961.577	0.040	328	961.650	0.100	329	961.747	1.080	266	961.971	4.060	72	962.416	0.290	348
961.578	0.040	328	961.651	0.100	329	961.748	1.550	266	961.972	4.220	72	962.417	0.280	348
961.579	0.040	328	961.652	0.100	329	961.749	2.200	266	961.975	3.800	72	962.418	0.270	348
961.580	0.040	328	961.653	0.100	329	961.751	0.850	266	961.976	3.960	72	962.419	0.260	348
961.581	0.040	328	961.654	0.100	329	961.752	1.120	266	961.977	4.240	72	962.420	0.350	348
961.582	0.040	328	961.655	0.100	329	961.753	1.360	266	961.978	4.450	72	962.421	0.240	348
961.583	0.040	328	961.656	0.100	329	961.754	1.620	266	961.983	4.120	72	962.422	0.230	348
961.584	0.040	328	961.657	0.100	329	961.756	0.900	266	961.984	4.500	72	962.423	0.200	348
961.585	0.040	328	961.658	0.100	329	961.757	1.140	266	961.985	5.200	72	962.424	0.190	348
961.586	0.030	328	961.659	0.090	329	961.758	1.630	266	961.988	3.920	72	962.437	0.120	348
961.587	0.040	328	961.660	0.090	329	961.761	0.900	266	961.989	4.200	72	962.438	0.120	348
961.588	0.040	328	961.661	0.090	329	961.762	1.120	266	961.990	4.660	72	962.439	0.120	348
961.589	0.030	328	961.662	0.090	329	961.763	1.620	266	961.991	5.030	72	962.440	0.120	348
961.590	0.030	328	961.663	0.090	329	961.773	0.100	264	961.992	5.980	72	962.441	0.120	348
961.591	0.030	328	961.664	0.080	329	961.774	0.140	264	962.121S	1.480	136	962.442	0.120	348
961.592	0.030	328	961.665	0.080	329	961.775	0.390	264	962.124S	1.900	136	962.443	0.110	348
961.593	0.030	328	961.666	0.080	329	961.776	0.430	264	962.205	0.060	349	962.444	0.110	348
961.595	0.350	333	961.667	0.080	329	961.777	0.060	264	962.248	0.250	349	962.445	0.100	348
961.596	0.080	352	961.668	0.080	329	961.778	0.120	264	962.249	0.220	349	962.446	0.100	348
961.597	0.060	334	961.669	0.070	329	961.779	0.180	264	962.250	0.190	349	962.447	0.080	348
961.598	0.020	335	961.670	0.070	329	961.831	0.840	134	962.260	0.090	349	962.448	0.070	348
961.599	0.020	327	961.671	0.070	329	961.833	1.000	134	962.262	0.090	349	962.457	0.350	348
961.601	0.070	328	961.672	0.060	329	961.835	1.120	134	962.263	0.090	349	962.458	0.340	348
961.602	0.080	328	961.673	0.060	329	961.839	1.370	134	962.264	0.080	349	962.459	0.340	348
961.603	0.070	328	961.674	0.060	329	961.876	3.200	135	962.265	0.070	349	962.460	0.330	348
961.604	0.070	328	961.675	0.050	329	961.889	3.450	135	962.266	0.050	349	962.461	0.310	348
961.605	0.070	328	961.676	3.960	333	961.902	0.470	71	962.271	0.160	349	962.462	0.310	348
961.606	0.070	328	961.677	0.550	333	961.903	0.530	71	962.272	0.160	349	962.463	0.290	348
961.607	0.070	328	961.678	0.100	352	961.908	0.560	71	962.273	0.160	349	962.464	0.270	348
961.608	0.080	328	961.679	0.080	334	961.909	0.720	71	962.274	0.150	349	962.465	0.190	348
961.609	0.070	328	961.680	0.010	335	961.915	0.560	71	962.276	0.130	349	962.468	0.070	347
961.610	0.070	328	961.681	0.010	335	961.916	0.920	71	962.278	0.090	349	962.469	0.060	347
961.611	0.070	328	961.683	0.020	335	961.917	0.440	71	962.281	0.290	349	962.470	0.050	347
961.612	0.070	328	961.684	0.020	335	961.918	0.480	71	962.282	0.290	349	962.471	0.040	347
961.613	0.070	328	961.685	0.020	335	961.919	0.470	71	962.283	0.300	349	962.472	0.100	347
961.614	0.070	328	961.701	0.230	265	961.920	0.570	71	962.284	0.290	349	962.473	0.110	347
961.615	0.070	328	961.702	0.330	265	961.921	0.510	71	962.285	0.270	349	962.474	0.110	347
961.616	0.060	328	961.703	0.520	265	961.922	0.650	71	962.286	0.270	349	962.475	0.110	347
961.617	0.070	328	961.706	0.250	265	961.923	0.520	71	962.287	0.260	349	962.476	0.110	347
961.618	0.070	328	961.707	0.350	265	961.924	0.720	71	962.288	0.240	349	962.477	0.110	347
961.619	0.060	328	961.708	0.540	265	961.925	0.540	71	962.289	0.180	349	962.478	0.100	347
961.620	0.060	328	961.711	0.270	265	961.926	0.830	71	962.291	0.210	352	962.479	0.100	347
961.621	0.060	328	961.712	0.360	265	961.932	1.060	71	962.292	0.380	352	962.480	0.090	347
961.622	0.060	328	961.713	0.550	265	961.933	1.130	71	962.293	0.400	352	962.481	0.090	347
961.623	0.060	328	961.714	0.920	265	961.935	1.150	71	962.294	0.170	352	962.483	0.060	347
961.624	0.060	328	961.716	0.300	265	961.936	1.270	71	962.312	0.020	350	962.484	0.180	347
961.625	0.060	328	961.717	0.300	265	961.938	1.200	71	962.313	0.080	350	962.485	0.180	347
961.626	0.050	328	961.718	0.300	265	961.939	1.390	71	962.401	0.120	348	962.486	0.170	347
961.627	0.050	328	961.721	0.520	265	961.941	1.270	71	962.402	0.110	348	962.487	0.170	347
961.629	0.730	333	961.722	0.670	265	961.942	1.550	71	962.403	0.100	348	962.488	0.080	347
961.630	0.080	352	961.723	0.530	265	961.944	1.360	71	962.404	0.090	348	962.489	0.140	347

List with Order Numbers and Weights

Order No.	Weight (kg)	Page	Order No.	Weight (kg)	Page	Order No.	Weight (kg)	Page	Order No.	Weight (kg)	Page	Order No.	Weight (kg)	Page
962.491	0.100	347	963.629	0.220	356	963.691	0.750	360	966.099	1.300	522	966.171	2.200	520
962.492	0.330	347	963.630	0.280	356	963.692	0.900	360	966.100	1.500	522	966.172	2.400	520
962.493	0.320	347	963.631	0.360	356	963.693	1.080	360	966.101	0.320	521	966.173	0.074	523
962.494	0.320	347	963.632	0.100	356	963.700	0.020	364	966.102	0.340	521	966.174	0.160	523
962.495	0.310	347	963.633	0.160	356	963.702	0.020	364	966.103	0.400	521	966.181	0.160	526
962.496	0.290	347	963.634	0.210	356	963.703	0.140	364	966.104	0.380	521	966.182	0.250	526
962.497	0.290	347	963.635	0.280	356	963.711	0.010	364	966.105	0.600	521	966.183	0.290	526
962.499	0.250	347	963.636	0.360	356	963.713	0.020	364	966.106	0.580	521	966.184	0.600	526
962.500	0.190	347	963.637	0.180	358	963.721	0.005	364	966.107	0.600	521	966.185	0.520	526
962.571	0.370	377	963.638	0.280	358	963.722	0.010	364	966.108	0.600	521	966.186	1.220	526
962.572	0.310	377	963.639	0.340	358	963.723	0.020	364	966.109	0.600	521	966.187	1.000	526
962.574	0.170	377	963.640	0.460	358	964.101S	0.730	74	966.110	0.700	521	966.206	1.200	520
962.581	0.520	355	963.641	0.850	358	964.102S	0.880	74	966.111	0.720	521	966.207	1.250	520
962.582	0.340	355	963.642	0.180	358	964.103S	1.040	74	966.112	1.000	521	966.208	1.330	520
962.586	0.320	355	963.643	0.280	358	964.190S	1.320	74	966.115	0.270	523	966.209	1.300	520
962.596	0.160	355	963.644	0.340	358	964.191S	1.400	74	966.120	0.640	518	966.210	1.360	520
962.597	0.120	355	963.645	0.460	358	964.192S	1.540	74	966.121	1.260	518	966.211	1.400	520
962.598	0.290	355	963.646	0.580	358	964.194S	1.840	74	966.122	1.360	518	966.212	0.320	527
962.599	0.200	355	963.647	0.180	358	964.195S	2.140	74	966.123	1.700	518	966.213	0.500	527
962.642	4.100	159	963.648	0.270	358	964.196S	2.070	74	966.124	1.280	518	966.214	1.120	527
962.649	5.000	161	963.649	0.340	358	965.400	0.460	107	966.125	1.400	518	966.216	0.550	518
962.661	1.920	366	963.650	0.460	358	965.401	0.660	106	966.126	1.750	518	966.217	0.480	518
962.667	4.000	160	963.651	0.580	358	965.402	0.710	106	966.127	1.420	518	966.218	0.520	518
962.668	4.850	160	963.652	0.170	358	965.403	1.430	106	966.128	1.540	518	966.219	0.560	518
962.669	8.700	160	963.653	0.260	358	965.404	1.230	106	966.129	1.900	518	966.220	0.540	518
962.670	9.700	160	963.654	0.340	358	965.405	1.300	106	966.130	1.520	518	966.221	1.220	518
962.785	0.600	119	963.655	0.460	358	965.406	1.740	106	966.131	1.680	518	966.222	1.160	518
962.786	0.700	119	963.656	0.570	358	965.407	3.820	106	966.132	2.100	518	966.223	1.200	518
962.793	0.530	119	963.657	0.170	358	965.408	3.920	106	966.133	1.790	518	966.224	1.260	518
962.794	0.700	119	963.658	0.260	358	965.409	4.300	106	966.134	2.000	518	966.225	1.460	518
962.795	0.750	119	963.659	0.340	358	965.505	3.500	213	966.135	2.400	518	966.226	1.400	518
962.796	0.750	119	963.660	0.450	358	965.506	3.900	213	966.136	2.140	518	966.231	0.900	521
963.399	0.450	359	963.661	0.570	358	965.511S	1.400	180	966.137	2.400	518	966.232	0.890	521
963.400	0.110	357	963.662	0.520	360	965.523	3.190	194	966.138	2.940	518	966.233	0.930	521
963.401	1.280	152	963.663	0.800	360	965.601	0.530	201	966.141	0.800	521	966.234	1.000	521
963.402	1.320	152	963.664	0.950	360	965.602	0.700	201	966.142	1.100	521	966.235	1.100	521
963.403	1.820	152	963.665	1.150	360	965.603	0.800	201	966.143	1.300	521	966.236	1.160	521
963.404	3.420	152	963.666	0.520	360	965.604	0.820	201	966.144	1.000	521	966.237	0.110	525
963.405	3.480	152	963.667	0.780	360	965.606	1.000	201	966.145	1.200	521	966.238	0.120	525
963.406	4.060	152	963.668	0.940	360	965.607	1.080	201	966.146	1.400	521	966.239	0.120	525
963.432	0.010	364	963.669	1.120	360	965.608	1.660	201	966.147	1.100	521	966.240	0.230	525
963.601	0.510	273	963.670	0.510	360	965.609	2.410	201	966.148	1.230	521	966.241	0.400	525
963.602	0.750	273	963.671	0.780	360	965.610	2.510	201	966.149	1.500	521	966.242	0.700	525
963.603	1.480	273	963.672	0.930	360	965.611	3.100	201	966.150	1.220	521	966.243	0.800	525
963.611	0.110	356	963.673	1.110	360	966.081	0.520	519	966.151	1.220	521	966.244	0.960	525
963.612	0.180	356	963.674	0.510	360	966.082	0.620	519	966.152	1.700	521	966.245	0.001	528
963.613	0.220	356	963.675	0.800	360	966.083	0.620	519	966.153	1.300	521	966.248	0.002	528
963.614	0.300	356	963.676	0.950	360	966.084	0.710	519	966.154	1.650	521	966.249	0.002	528
963.615	0.110	356	963.677	1.150	360	966.085	1.300	519	966.155	1.860	521	966.250	0.001	528
963.616	0.180	356	963.678	0.510	360	966.086	1.320	519	966.156	1.840	521	966.253	0.002	528
963.617	0.220	356	963.679	0.800	360	966.087	1.400	519	966.157	2.040	521	966.254	0.003	528
963.618	0.300	356	963.680	0.930	360	966.088	1.500	519	966.158	2.800	521	966.255	0.001	528
963.619	0.110	356	963.681	1.100	360	966.089	1.440	519	966.161	1.300	520	966.258	0.002	528
963.620	0.170	356	963.682	0.500	360	966.090	1.580	519	966.162	1.400	520	966.259	0.003	528
963.621	0.220	356	963.683	0.760	360	966.091	1.700	519	966.163	1.100	520	966.260	0.001	528
963.622	0.300	356	963.684	0.910	360	966.092	1.740	519	966.164	1.300	520	966.263	0.005	528
963.623	0.110	356	963.685	1.090	360	966.093	0.900	522	966.165	1.200	520	966.264	0.005	528
963.624	0.170	356	963.686	0.490	360	966.094	1.000	522	966.166	1.600	520	966.265	0.005	528
963.625	0.220	356	963.687	0.750	360	966.095	1.000	522	966.167	1.500	520	966.268	0.005	528
963.626	0.300	356	963.688	0.900	360	966.096	1.200	522	966.168	1.700	520	966.269	0.005	528
963.627	0.110	356	963.689	1.090	360	966.097	1.100	522	966.169	1.700	520	966.270	0.005	528
963.628	0.170	356	963.690	0.500	360	966.098	1.130	522	966.170	2.000	520	966.271	0.040	503

List with Order Numbers and Weights

Order No.	Weight (kg)	Page	Order No.	Weight (kg)	Page	Order No.	Weight (kg)	Page	Order No.	Weight (kg)	Page	Order No.	Weight (kg)	Page
966.272	0.040	503	966.474	0.070	558	966.639	1.400	534	967.523	0.020	342	967.585	0.060	343
966.273	0.050	503	966.475	0.070	558	966.640	1.100	534	967.524	0.020	342	967.586	0.060	343
966.274	0.040	540	966.476	0.070	558	966.641	1.280	534	967.525	0.020	342	967.587	0.060	343
966.275	0.040	540	966.477	0.080	558	966.642	1.500	534	967.526	0.020	342	967.588	0.060	343
966.280	0.005	528	966.478	0.130	558	966.652	0.001	537	967.527	0.020	342	967.589	0.050	343
966.283	0.005	528	966.479	0.150	558	966.653	0.003	537	967.528	0.020	342	967.590	0.050	343
966.284	0.005	528	966.480	0.140	558	966.658	0.001	537	967.529	0.020	342	967.591	0.050	343
966.285	0.005	528	966.481	0.170	558	966.662	0.001	537	967.530	0.020	342	967.592	0.140	343
966.288	0.002	528	966.482	0.260	558	966.663	0.001	537	967.531	0.020	342	967.593	0.140	343
966.289	0.002	528	966.483	0.280	558	966.667	0.001	537	967.532	0.040	342	967.594	0.140	343
966.341	0.980	102	966.484	0.260	558	966.668	0.001	537	967.533	0.040	342	967.595	0.140	343
966.353	1.300	87	966.485	0.320	558	966.669	0.005	537	967.534	0.040	342	967.596	0.140	343
966.354	1.300	87	966.486	0.040	557	966.671	0.500	534	967.535	0.040	342	967.597	0.140	343
966.401	0.210	551	966.487	0.040	557	966.672	0.600	534	967.536	0.040	342	967.598	0.140	343
966.404	3.200	551	966.488	0.050	557	966.673	0.600	534	967.537	0.040	342	967.599	0.140	343
966.405	0.400	551	966.489	0.180	557	966.674	0.700	534	967.538	0.040	342	967.600	0.140	343
966.406	0.430	551	966.501	0.040	563	966.675	0.820	535	967.539	0.040	342	967.601	0.140	343
966.407	0.390	552	966.502	0.140	563	966.676	1.000	535	967.540	0.040	342	967.602	0.140	343
966.408	0.130	569	966.503	0.160	563	966.677	1.100	535	967.541	0.040	342	967.603	0.140	343
966.409	0.004	569	966.504	0.810	563	966.678	0.990	535	967.542	0.040	342	967.604	0.140	343
966.411	0.420	568	966.505	0.120	564	966.679	1.100	535	967.543	0.040	342	967.605	0.140	343
966.412	0.480	568	966.506	0.290	564	966.680	1.060	535	967.544	0.040	342	967.606	0.140	343
966.413	1.120	568	966.530	0.001	566	966.681	1.260	535	967.545	0.040	342	967.607	0.140	343
966.414	1.280	568	966.531	0.001	566	966.682	1.320	535	967.546	0.040	342	967.608	0.140	343
966.415	0.090	568	966.532	0.001	566	966.683	0.510	531	967.547	0.040	342	967.609	0.140	343
966.416	0.130	568	966.533	0.001	566	966.684	0.500	532	967.548	0.040	342	967.610	0.140	343
966.417	0.270	568	966.534	0.001	566	966.685	0.520	531	967.549	0.040	342	967.611	0.140	343
966.418	0.420	568	966.535	0.001	566	966.686	0.580	532	967.550	0.040	342	967.612	0.140	343
966.422	0.030	568	966.536	0.001	566	966.687	0.520	531	967.551	0.040	342	967.613	0.140	343
966.423	0.050	568	966.537	0.001	566	966.688	0.640	532	967.552	0.040	342	967.614	0.140	343
966.424	0.090	568	966.601	1.100	533	966.689	0.550	531	967.553	0.040	342	967.615	0.140	343
966.425	0.250	568	966.602	1.500	533	966.690	0.700	532	967.554	0.040	342	967.616	0.140	343
966.431	0.040	557	966.603	1.600	533	966.691	1.200	532	967.555	0.040	342	967.617	0.140	343
966.432	0.040	556	966.604	0.950	533	966.692	1.320	532	967.556	0.030	342	967.618	0.140	343
966.433	0.080	555	966.605	1.300	533	966.693	1.300	532	967.557	0.030	342	967.619	0.140	343
966.434	0.300	555	966.606	1.700	533	966.694	1.480	532	967.558	0.030	342	967.620	0.130	343
966.435	1.040	555	966.607	1.100	533	966.695	1.440	532	967.559	0.080	343	967.621	0.130	343
966.436	0.150	557	966.608	1.320	533	966.696	1.580	532	967.560	0.080	343	967.622	0.130	343
966.437	0.150	557	966.609	1.800	533	966.697	1.670	532	967.561	0.080	343	967.623	0.130	343
966.440	0.001	561	966.610	1.220	533	966.698	1.780	532	967.562	0.070	343	967.624	0.130	343
966.441	0.001	561	966.611	1.450	533	967.501	0.030	342	967.563	0.070	343	967.625	0.130	343
966.442	0.001	561	966.612	1.610	533	967.502	0.030	342	967.564	0.070	343	967.627	0.120	343
966.443	0.001	561	966.616	1.220	531	967.503	0.030	342	967.565	0.070	343	967.628	0.110	343
966.445	0.001	541	966.617	1.420	531	967.504	0.030	342	967.566	0.070	343	967.629	0.110	343
966.446	0.001	541	966.618	1.600	531	967.505	0.030	342	967.567	0.080	343	967.630	0.110	343
966.447	0.002	561	966.619	1.160	531	967.506	0.030	342	967.568	0.080	343	967.631	0.110	343
966.448	0.020	503	966.620	1.530	531	967.507	0.030	342	967.569	0.080	343	967.632	0.100	343
966.449	0.010	503	966.621	1.600	531	967.508	0.030	342	967.570	0.080	343	967.801	0.070	344
966.450	0.010	503	966.622	1.200	531	967.509	0.030	342	967.571	0.070	343	967.802	0.100	344
966.461	0.070	555	966.623	1.480	531	967.510	0.030	342	967.572	0.070	343	967.803	0.140	344
966.462	0.080	555	966.624	1.800	531	967.511	0.020	342	967.573	0.070	343	967.804	0.140	344
966.463	0.090	555	966.625	1.260	531	967.512	0.020	342	967.574	0.070	343	967.810	0.005	370
966.464	0.160	555	966.626	1.500	531	967.513	0.020	342	967.575	0.070	343	967.811	0.011	370
966.465	0.310	555	966.627	1.900	531	967.514	0.020	342	967.576	0.070	343	967.812	0.014	370
966.466	0.370	555	966.631	0.870	534	967.515	0.020	342	967.577	0.070	343	967.813	0.020	370
966.467	1.240	555	966.632	1.080	534	967.516	0.020	342	967.578	0.070	343	967.814	0.029	370
966.468	0.040	556	966.633	1.200	534	967.517	0.020	342	967.579	0.070	343	967.850	0.080	345
966.469	0.040	556	966.634	0.900	534	967.518	0.020	342	967.580	0.070	343	967.851	0.080	345
966.470	0.050	556	966.635	1.200	534	967.519	0.020	342	967.581	0.070	343	967.852	0.080	345
966.471	0.140	556	966.636	1.200	534	967.520	0.020	342	967.582	0.070	343	967.853	0.080	345
966.472	0.040	558	966.637	0.920	534	967.521	0.020	342	967.583	0.060	343	967.854	0.080	345
966.473	0.040	558	966.638	1.120	534	967.522	0.020	342	967.584	0.060	343	967.855	0.080	345

List with Order Numbers and Weights

Order No.	Weight (kg)	Page	Order No.	Weight (kg)	Page	Order No.	Weight (kg)	Page	Order No.	Weight (kg)	Page	Order No.	Weight (kg)	Page
967.856	0.080	345	967.920	0.220	346	968.113	7.100	173	968.199	1.140	64	968.270	2.550	171
967.857	0.080	345	967.921	0.220	346	968.114	5.500	173	968.200	1.400	64	968.271	2.640	171
967.858	0.080	345	967.922	0.220	346	968.121	3.980	174	968.201	1.400	64	968.272	2.760	171
967.859	0.080	345	967.923	0.220	346	968.122	4.880	174	968.202	1.700	64	968.273	3.020	171
967.861	0.080	345	967.924	0.220	346	968.123	5.780	174	968.203	1.800	64	968.274	2.500	171
967.862	0.080	345	967.925	0.220	346	968.124	4.240	174	968.204	1.940	64	968.275	2.500	171
967.863	0.080	345	967.926	0.220	346	968.125	5.360	174	968.205	2.500	64	968.276	2.650	171
967.864	0.080	345	967.927	0.220	346	968.126	6.800	174	968.206	3.100	64	968.277	2.760	171
967.865	0.110	345	967.928	0.220	346	968.127	4.780	174	968.207	1.200	65	968.278	2.920	171
967.866	0.110	345	967.929	0.220	346	968.128	5.540	174	968.208	1.380	65	968.279	3.300	171
967.867	0.110	345	967.930	0.220	346	968.129	6.840	174	968.209	1.570	65	968.280	2.600	171
967.868	0.110	345	967.931	0.220	346	968.130	5.500	174	968.210	1.780	65	968.281	2.600	171
967.869	0.110	345	967.932	0.220	346	968.131	3.280	174	968.211	2.020	65	968.282	2.740	171
967.870	0.110	345	967.933	0.220	346	968.132	3.500	173	968.212	2.280	65	968.283	2.920	171
967.871	0.110	345	967.934	0.220	346	968.136S	1.720	180	968.213	2.740	65	968.284	3.100	171
967.872	0.110	345	968.026	5.200	67	968.137S	2.000	180	968.214	3.700	65	968.285	3.560	171
967.873	0.110	345	968.027	5.700	67	968.142	1.110	131	968.216	3.800	65	968.287	2.760	171
967.874	0.110	345	968.028	6.600	67	968.144	1.200	131	968.217	3.920	65	968.288	3.000	171
967.875	0.010	345	968.030	6.800	67	968.145	1.300	131	968.218	4.400	65	968.289	3.360	171
967.876	0.010	345	968.031	7.700	67	968.147	1.300	131	968.219	4.900	65	968.290	3.420	171
967.877	0.110	345	968.033	7.460	67	968.148	1.400	131	968.220	3.900	65	968.291	4.000	171
967.878	0.110	345	968.034	8.900	67	968.150	1.100	131	968.221	4.040	65	968.301	0.002	324
967.879	0.110	345	968.036	4.800	67	968.151	1.700	131	968.222	4.600	65	968.302	0.002	324
967.880	0.110	345	968.037	8.300	67	968.152	1.910	131	968.223	5.200	65	968.303	0.002	324
967.881	0.110	345	968.038	9.560	67	968.154	3.300	131	968.224	4.000	65	968.304	0.002	324
967.882	0.110	345	968.039	12.100	67	968.156	3.340	131	968.225	4.160	65	968.305	0.002	324
967.883	0.110	345	968.041	6.000	67	968.159	3.600	131	968.226	4.900	65	968.306	0.002	324
967.884	0.120	345	968.042	7.800	67	968.161	3.600	131	968.227	5.500	65	968.307	0.002	324
967.885	0.160	346	968.043	9.600	67	968.162	3.800	131	968.228	4.020	65	968.308	0.002	324
967.886	0.160	346	968.055	4.100	173	968.163	4.400	131	968.229	4.410	65	968.309	0.002	324
967.887	0.160	346	968.056	4.700	173	968.166	0.500	64	968.230	5.230	65	968.310	0.002	324
967.888	0.160	346	968.057	6.900	173	968.167	0.580	64	968.231	6.000	65	968.311	0.002	324
967.889	0.160	346	968.059	5.020	132	968.168	0.700	64	968.235	0.350	170	968.312	0.002	324
967.890	0.160	346	968.060	5.120	132	968.169	1.000	64	968.236	0.416	170	968.313	0.002	324
967.891	0.150	346	968.061	5.800	132	968.170	0.500	64	968.238	0.410	170	968.314	0.002	324
967.892	0.150	346	968.076	5.160	69	968.171	0.620	64	968.239	0.465	170	968.315	0.002	324
967.893	0.150	346	968.077	5.700	69	968.172	0.800	64	968.241	0.470	170	968.316	0.002	324
967.894	0.150	346	968.078	6.600	69	968.173	0.800	64	968.242	0.670	170	968.317	0.002	324
967.895	0.150	346	968.079	7.000	69	968.174	0.520	64	968.243	0.540	170	968.318	0.002	324
967.896	0.150	346	968.080	6.770	69	968.175	0.800	64	968.244	0.688	170	968.319	0.002	324
967.897	0.150	346	968.081	7.700	69	968.176	1.000	64	968.247	0.800	170	968.320	0.002	324
967.898	0.150	346	968.082	9.100	69	968.177	1.000	64	968.248	0.980	170	968.321	0.002	324
967.899	0.150	346	968.083	7.480	69	968.178	0.560	64	968.249	1.100	170	968.322	0.002	324
967.900	0.150	346	968.084	8.900	69	968.179	0.590	64	968.250	1.180	170	968.323	0.002	324
967.901	0.150	346	968.085	10.800	69	968.180	0.960	64	968.251	1.300	170	968.324	0.001	324
967.902	0.160	346	968.086	4.800	69	968.181	1.120	64	968.252	0.900	170	968.325	0.001	324
967.903	0.160	346	968.087	8.320	69	968.183	1.080	64	968.253	1.050	170	968.326	0.002	324
967.904	0.150	346	968.088	9.580	69	968.184	1.400	64	968.254	1.180	170	968.327	0.001	324
967.905	0.150	346	968.089	12.100	69	968.185	1.200	64	968.255	1.300	170	968.328	0.002	324
967.906	0.150	346	968.090	14.300	69	968.186	1.300	64	968.256	1.450	170	968.329	0.005	324
967.908	0.220	346	968.091	6.000	69	968.187	1.500	64	968.257	1.000	170	968.330	0.110	326
967.909	0.220	346	968.092	7.800	69	968.188	1.560	64	968.258	1.140	170	968.334	0.003	324
967.910	0.220	346	968.093	9.600	69	968.189	1.900	64	968.259	1.290	170	968.335	0.003	324
967.911	0.220	346	968.095	3.950	174	968.190	2.400	64	968.260	1.480	170	968.336	0.003	324
967.912	0.220	346	968.105	3.970	173	968.191	1.120	64	968.261	1.550	170	968.337	0.003	324
967.913	0.220	346	968.106	5.000	173	968.192	1.300	64	968.262	1.150	170	968.338	0.003	324
967.914	0.220	346	968.107	5.900	173	968.193	1.300	64	968.263	1.320	170	968.339	0.003	324
967.915	0.220	346	968.108	3.900	173	968.194	1.500	64	968.264	1.480	170	968.340	0.002	324
967.916	0.220	346	968.109	5.600	173	968.195	1.700	64	968.265	1.670	170	968.341	0.003	324
967.917	0.220	346	968.110	6.800	173	968.196	1.730	64	968.266	1.830	170	968.342	0.003	324
967.918	0.220	346	968.111	4.760	173	968.197	2.100	64	968.268	2.350	171	968.343	0.003	324
967.919	0.220	346	968.112	5.800	173	968.198	2.600	64	968.269	2.450	171	968.344	0.003	324

List with Order Numbers and Weights

Order No.	Weight (kg)	Page	Order No.	Weight (kg)	Page	Order No.	Weight (kg)	Page	Order No.	Weight (kg)	Page	Order No.	Weight (kg)	Page
968.345	0.003	324	968.412	0.004	325	968.578	2.660	178	968.783	0.940	177	968.871	0.080	216
968.346	0.003	324	968.413	0.004	325	968.580	2.610	178	968.784	1.130	177	968.872	0.070	216
968.347	0.003	324	968.414	0.003	325	968.581	2.840	178	968.785	1.310	177	968.873	0.100	216
968.348	0.003	324	968.415	0.004	325	968.583	2.720	178	968.787	1.100	177	968.874	0.070	216
968.349	0.003	324	968.421	0.010	340	968.584	3.020	178	968.788	1.290	177	968.875	0.090	216
968.350	0.003	324	968.423	0.010	340	968.587	2.890	178	968.789	1.580	177	968.876	0.140	217
968.351	0.003	324	968.424	0.010	340	968.588	3.320	178	968.790	1.850	177	968.877	0.150	217
968.352	0.002	324	968.425	0.010	340	968.592	2.680	178	968.791	2.200	177	968.878	0.140	217
968.353	0.003	324	968.427	0.020	340	968.593	3.000	178	968.792	1.070	177	968.879	0.150	217
968.354	0.003	324	968.429	0.020	340	968.594	3.800	178	968.793	1.380	177	968.880	0.140	216
968.355	0.002	324	968.430	0.020	340	968.604	1.340	71	968.794	1.650	177	968.881	0.160	216
968.356	0.003	324	968.431	0.020	340	968.610	1.660	71	968.795	2.300	177	968.882	0.140	216
968.357	0.002	324	968.433	0.020	340	968.611	1.250	71	968.796	2.470	177	968.883	0.160	216
968.358	0.002	324	968.434	0.040	340	968.613	1.770	71	968.803	0.790	165	968.884	0.160	218
968.359	0.002	324	968.436	0.040	340	968.708	4.600	69	968.811	0.870	168	968.885	0.190	218
968.360	0.002	324	968.437	0.040	340	968.709	5.030	69	968.812	0.900	168	968.886	0.200	218
968.361	0.003	324	968.438	0.040	340	968.710	5.920	69	968.813	0.940	168	968.887	0.270	218
968.362	0.002	324	968.440	0.040	340	968.711	5.360	69	968.814	0.880	168	968.888	0.280	218
968.363	0.003	324	968.442	0.030	340	968.712	6.500	69	968.815	0.870	168	968.889	0.310	218
968.364	0.120	326	968.443	0.070	340	968.713	5.460	69	968.816	0.940	168	968.890	0.230	216
968.369	0.004	325	968.445	0.070	340	968.714	6.890	69	968.818	1.150	168	968.891	0.260	216
968.370	0.004	325	968.446	0.070	340	968.716	0.220	217	968.819	0.910	168	968.892	0.240	216
968.371	0.004	325	968.447	0.070	340	968.717	0.250	218	968.820	1.050	168	968.893	0.270	216
968.372	0.005	325	968.448	0.060	340	968.718	0.300	218	968.822	1.350	168	968.894	0.310	216
968.373	0.005	325	968.449	0.060	340	968.719	0.290	218	968.823	0.960	168	968.895	0.270	218
968.374	0.004	325	968.451	0.060	340	968.720	0.360	218	968.824	1.120	168	968.896	0.340	218
968.375	0.004	325	968.453	0.050	340	968.721	0.350	218	968.826	1.540	168	968.897	0.400	218
968.376	0.004	325	968.461	0.040	340	968.722	0.490	218	968.827	1.020	168	968.898	0.430	218
968.377	0.004	325	968.462	0.070	340	968.723	0.470	218	968.828	1.280	168	968.899	0.420	218
968.378	0.004	325	968.463	0.083	340	968.725	0.419	217	968.829	1.580	168	968.900	0.420	218
968.379	0.005	325	968.464	0.150	340	968.727	0.500	219	968.830	1.860	168	968.901	0.570	218
968.380	0.005	325	968.468	0.050	341	968.728	0.490	219	968.831	2.400	168	968.902	0.794	218
968.381	0.005	325	968.469	0.050	341	968.729	0.500	219	968.832	1.060	168	968.903	1.000	218
968.382	0.005	325	968.470	0.050	341	968.730	0.600	219	968.833	1.380	168	968.904	0.430	218
968.383	0.005	325	968.471	0.050	341	968.731	0.540	219	968.835	2.040	168	968.905	0.540	218
968.384	0.005	325	968.472	0.070	341	968.732	0.700	219	968.836	2.500	168	968.906	0.500	216
968.385	0.005	325	968.473	0.070	341	968.733	0.620	219	968.841	2.440	169	968.907	0.460	216
968.386	0.005	325	968.474	0.070	341	968.734	0.750	219	968.842	2.400	169	968.910	1.150	219
968.387	0.005	325	968.475	0.070	341	968.735	0.900	219	968.843	2.520	169	968.911	1.020	219
968.388	0.005	325	968.476	0.070	341	968.736	0.880	219	968.844	2.400	169	968.912	1.500	219
968.389	0.005	325	968.477	0.070	341	968.738	0.570	167	968.845	2.500	169	968.914	0.130	217
968.390	0.005	325	968.478	0.100	341	968.742	1.010	167	968.846	2.700	169	968.915	0.220	217
968.391	0.005	325	968.479	0.100	341	968.745	0.660	167	968.847	2.590	169	968.916	0.408	217
968.392	0.005	325	968.480	0.100	341	968.752	0.090	218	968.848	2.600	169	968.917	0.150	216
968.393	0.005	325	968.481	0.100	341	968.753	0.120	218	968.849	2.840	169	968.918	0.170	216
968.394	0.005	325	968.482	0.100	341	968.754	0.180	218	968.850	2.540	169	968.919	0.320	216
968.395	0.005	325	968.483	0.100	341	968.756	0.230	217	968.851	2.720	169	968.920	0.250	216
968.396	0.004	325	968.484	0.100	341	968.757	0.230	217	968.852	2.990	169	968.921	0.443	216
968.397	0.004	325	968.485	0.100	341	968.759	0.500	217	968.853	3.280	169	968.925	0.260	164
968.398	0.004	325	968.486	0.150	341	968.760	0.460	217	968.854	2.620	169	968.926	0.280	164
968.399	0.005	325	968.487	0.150	341	968.761	0.600	219	968.855	2.900	169	968.927	0.310	164
968.400	0.005	325	968.488	0.150	341	968.763	1.000	219	968.856	3.320	169	968.929	0.250	165
968.401	0.004	325	968.489	0.150	341	968.764	0.770	219	968.857	3.680	169	968.930	0.280	165
968.402	0.004	325	968.490	0.150	341	968.771	0.900	177	968.858	2.700	169	968.931	0.250	165
968.403	0.004	325	968.491	0.150	341	968.772	0.900	177	968.859	3.000	169	968.932	0.260	165
968.404	0.004	325	968.492	0.150	341	968.773	0.960	177	968.860	3.500	169	968.933	0.240	165
968.405	0.004	325	968.493	0.150	341	968.775	0.860	177	968.861	3.920	169	968.934	0.260	164
968.406	0.004	325	968.494	0.150	341	968.776	0.980	177	968.866	0.060	217	968.936	0.260	164
968.408	0.004	325	968.495	0.150	341	968.777	1.080	177	968.867	0.072	217	968.937	0.290	164
968.409	0.004	325	968.572	2.500	178	968.779	0.900	177	968.868	0.060	217	968.940	0.280	166
968.410	0.004	325	968.573	2.600	178	968.780	1.050	177	968.869	0.080	217	968.941	0.340	166
968.411	0.004	325	968.575	2.600	178	968.781	1.200	177	968.870	0.160	216	968.942	0.350	166

List with Order Numbers and Weights

Order No.	Weight (kg)	Page	Order No.	Weight (kg)	Page	Order No.	Weight (kg)	Page	Order No.	Weight (kg)	Page	Order No.	Weight (kg)	Page
968.943	0.310	166	969.083	3.420	135	969.322	0.980	58	969.461	0.560	353	969.533	1.080	61
968.945	0.410	166	969.084	3.600	135	969.323	1.080	58	969.462	0.360	351	969.534	0.660	60
968.946	0.350	166	969.085	4.000	135	969.324	0.980	58	969.462L	0.570	351	969.535	1.420	61
968.948	0.490	166	969.087	2.980	135	969.325	1.100	58	969.463	0.520	353	969.536	1.560	61
968.949	0.460	166	969.088	3.200	135	969.326	1.000	58	969.464L	0.780	351	969.537	1.720	61
968.950	0.460	166	969.090	4.000	135	969.327	1.100	58	969.465	0.370	351	969.538	1.100	61
968.951	0.520	166	969.091	4.340	135	969.328	1.120	58	969.465L	0.640	351	969.539	1.280	61
968.952	0.780	166	969.208	1.100	128	969.329	1.200	58	969.466	0.790	353	969.540	1.560	61
968.953	0.700	166	969.209	0.380	58	969.330	0.990	58	969.467L	0.850	351	969.541	1.760	61
968.961	0.770	164	969.210	0.400	58	969.331	1.000	58	969.468L	0.960	351	969.542	1.960	61
968.963	0.860	164	969.211	0.480	58	969.332	1.030	58	969.469L	0.980	351	969.543	1.100	62
968.965	0.780	165	969.212	0.500	58	969.333	1.060	58	969.470L	1.040	351	969.544	1.400	62
968.966	0.820	164	969.213	0.500	58	969.334	1.120	58	969.471L	1.300	351	969.545	1.810	62
968.968	0.902	164	969.214	0.440	58	969.335	1.200	58	969.472L	1.700	351	969.546	2.100	62
968.970	0.774	164	969.215	0.470	58	969.341	0.480	60	969.473L	1.370	351	969.547	2.430	62
968.971	0.800	164	969.217	0.600	58	969.342	0.540	60	969.475	0.030	228	969.548	1.100	62
968.973	0.860	164	969.218	0.400	58	969.343	0.550	60	969.480	0.004	326	969.549	1.460	62
968.975	0.980	164	969.220	0.470	58	969.344	0.530	60	969.481	0.010	326	969.550	1.940	62
968.981	0.900	168	969.221	0.500	58	969.345	0.620	60	969.482	0.080	326	969.551	2.290	62
968.982	1.000	168	969.222	0.580	58	969.346	0.670	60	969.483	0.020	334	969.552	2.690	62
968.983	1.120	168	969.224	0.990	129	969.347	0.570	60	969.484	0.040	334	969.553	3.640	63
968.984	1.240	168	969.225	1.080	129	969.348	0.720	60	969.485	0.060	334	969.554	3.700	63
968.985	1.040	168	969.229	1.060	129	969.349	0.630	60	969.486	0.090	334	969.555	3.800	63
968.986	1.500	168	969.230	1.330	129	969.350	0.820	60	969.487	0.120	334	969.556	3.870	63
968.989	2.460	169	969.234	1.250	129	969.351	0.700	60	969.488	0.140	334	969.557	3.680	63
968.990	2.700	169	969.235	1.340	129	969.352	1.000	60	969.491	0.020	333	969.558	3.790	63
968.991	2.520	169	969.239	1.200	129	969.353	0.720	60	969.492	0.050	333	969.559	3.940	63
968.992	2.700	169	969.240	1.480	129	969.354	1.080	60	969.493	0.030	333	969.560	4.040	63
968.993	2.620	169	969.241	1.660	129	969.361	1.050	61	969.494	0.040	333	969.561	3.750	63
968.994	2.820	169	969.244	1.320	129	969.362	1.100	61	969.495	0.100	333	969.562	3.880	63
968.995	2.760	169	969.245	1.800	129	969.363	1.140	61	969.496	0.030	333	969.563	4.100	63
968.996	3.040	169	969.246	2.010	129	969.364	1.080	61	969.497	0.030	333	969.564	4.260	63
968.997	2.860	169	969.248	1.100	129	969.365	1.180	61	969.498	0.040	333	969.565	4.500	63
968.998	3.300	169	969.249	1.360	129	969.366	1.210	61	969.499	0.040	333	969.566	4.720	63
969.023	3.340	132	969.250	1.900	129	969.367	1.160	61	969.502	0.500	59	969.567	3.840	63
969.025	4.580	132	969.251	2.400	129	969.368	1.280	61	969.503	0.500	59	969.568	4.000	63
969.032	1.070	134	969.252	2.550	129	969.369	1.350	61	969.504	0.500	59	969.569	4.270	63
969.034	1.030	134	969.253	3.000	130	969.370	1.200	61	969.506	1.000	59	969.570	4.480	63
969.036	1.260	134	969.254	3.800	130	969.371	1.380	61	969.508	1.000	59	969.571	4.780	63
969.037	1.040	134	969.255	3.030	130	969.372	1.460	61	969.509	0.450	60	969.572	5.080	63
969.038	1.170	134	969.261	3.200	130	969.373	1.250	62	969.510	0.510	60	969.573	3.770	63
969.040	0.900	134	969.262	3.160	130	969.374	1.520	62	969.511	0.460	60	969.574	3.920	63
969.041	1.230	134	969.263	3.360	130	969.375	1.680	62	969.512	0.530	60	969.575	4.160	63
969.042	1.500	134	969.267	3.200	130	969.376	1.270	62	969.513	0.520	60	969.576	4.520	63
969.043	0.918	134	969.268	3.400	130	969.377	1.600	62	969.514	1.220	61	969.577	4.850	63
969.044	1.360	134	969.269	3.700	130	969.378	1.780	62	969.516	0.520	60	969.578	5.240	63
969.045	1.670	134	969.274	3.230	130	969.446	0.090	351	969.517	0.740	60	969.579	3.800	63
969.046	1.010	134	969.275	3.460	130	969.447	0.240	351	969.518	0.930	60	969.580	3.950	63
969.047	1.340	134	969.276	3.840	130	969.448	0.530	351	969.519	0.560	60	969.581	4.260	63
969.048	1.870	134	969.277	4.400	130	969.449	0.070	351	969.520	0.850	60	969.582	4.680	63
969.059	2.300	134	969.280	3.280	130	969.450	0.086	351	969.521	0.600	60	969.583	5.060	63
969.060	2.400	134	969.281	3.580	130	969.451	0.180	353	969.522	0.900	60	969.584	5.560	63
969.062	2.720	135	969.282	4.040	130	969.452	0.090	351	969.523	1.030	61	969.592	4.600	67
969.063	3.100	135	969.283	4.600	130	969.453	0.180	353	969.524	1.070	61	969.593	5.060	67
969.066	3.200	135	969.302	1.000	128	969.454	0.120	351	969.525	1.150	61	969.594	6.000	67
969.067	3.000	135	969.305	0.930	128	969.455	0.200	353	969.526	1.230	61	969.595	5.360	67
969.069	2.800	135	969.307	0.900	128	969.456	0.180	351	969.527	1.320	61	969.596	6.490	67
969.070	3.100	135	969.308	0.970	128	969.457	0.300	353	969.528	1.060	61	969.597	5.460	67
969.071	3.300	135	969.309	1.070	128	969.458	0.250	351	969.529	1.140	61	969.598	7.000	67
969.075	2.840	135	969.316	0.600	58	969.459	0.400	353	969.530	1.260	61	969.601	0.004	331
969.077	3.500	135	969.319	0.440	58	969.460	0.310	351	969.531	1.380	61	969.602	0.003	331
969.082	3.000	135	969.321	1.000	58	969.460L	0.200	351	969.532	1.500	61	969.603	0.003	331

List with Order Numbers and Weights

Order No.	Weight (kg)	Page	Order No.	Weight (kg)	Page	Order No.	Weight (kg)	Page	Order No.	Weight (kg)	Page	Order No.	Weight (kg)	Page
969.604	0.003	331	969.674	0.080	332	969.874	0.070	336	969.941	0.083	338	973.003	1.060	300
969.605	0.004	331	969.675	0.080	332	969.875	0.070	336	969.942	0.083	338	973.005	0.980	300
969.606	0.003	331	969.676	0.080	332	969.876	0.100	336	969.943	0.080	338	973.006	1.480	300
969.607	0.003	331	969.677	0.080	332	969.877	0.100	336	969.944	0.080	338	973.007	1.920	300
969.608	0.003	331	969.678	0.080	332	969.878	0.100	336	969.945	0.080	338	973.011	4.000	300
969.609	0.003	331	969.679	0.080	332	969.879	0.100	336	969.946	0.115	339	973.013	4.200	300
969.610	0.003	331	969.680	0.070	332	969.880	0.100	336	969.947	0.115	339	973.014	0.470	284
969.611	0.003	331	969.681	0.070	332	969.881	0.100	336	969.948	0.116	339	973.015	0.491	284
969.612	0.003	331	969.682	0.070	332	969.882	0.100	336	969.949	0.116	339	973.016	0.492	284
969.613	0.003	331	969.683	0.070	332	969.883	0.100	336	969.950	0.116	339	973.017	0.465	284
969.615	0.010	331	969.684	0.070	332	969.884	0.100	336	969.951	0.117	339	973.018	0.464	284
969.616	0.010	331	969.685	0.060	332	969.885	0.100	336	969.952	0.117	339	973.019	0.740	284
969.617	0.010	331	969.686	0.060	332	969.886	0.140	337	969.953	0.320	339	973.020	0.740	284
969.618	0.010	331	969.687	0.060	332	969.887	0.140	337	969.954	0.117	339	973.021	0.433	284
969.619	0.010	331	969.688	0.060	332	969.888	0.140	337	969.955	0.116	339	973.022	0.684	284
969.620	0.010	331	969.689	0.060	332	969.889	0.150	337	969.956	0.111	339	973.023	0.683	284
969.621	0.010	331	969.690	0.060	332	969.890	0.150	337	969.957	0.112	339	973.024	0.440	284
969.622	0.010	331	969.691	0.050	332	969.891	0.150	337	969.958	0.112	339	973.025	0.943	284
969.623	0.010	331	969.697	0.120	332	969.892	0.150	337	969.959	0.132	339	973.026	1.140	304
969.624	0.010	331	969.698	0.120	332	969.893	0.150	337	969.960	0.133	339	973.027	1.140	304
969.625	0.010	331	969.699	0.120	332	969.894	0.150	337	969.961	0.133	339	973.028	1.270	304
969.627	0.030	331	969.700	0.120	332	969.895	0.150	337	969.962	0.133	339	973.030	6.600	304
969.628	0.030	331	969.701	0.110	332	969.896	0.140	337	969.963	0.133	339	973.031	6.620	304
969.629	0.030	331	969.702	0.110	332	969.897	0.140	337	969.964	0.135	339	973.032	1.600	305
969.630	0.020	331	969.703	0.110	332	969.898	0.140	337	969.965	0.135	339	973.033	1.600	305
969.631	0.020	331	969.704	0.110	332	969.899	0.170	337	969.966	0.135	339	973.034	3.100	305
969.632	0.020	331	969.705	0.110	332	969.900	0.170	337	969.967	0.134	339	973.035	3.100	305
969.633	0.020	331	969.706	0.110	332	969.901	0.170	337	969.968	0.136	339	973.038	6.000	305
969.634	0.020	331	969.707	0.110	332	969.902	0.170	337	969.969	0.135	339	973.039	6.000	305
969.635	0.020	331	969.708	0.100	332	969.903	0.168	337	969.970	0.133	339	973.040	2.560	305
969.636	0.020	331	969.709	0.100	332	969.904	0.170	337	969.971	0.133	339	973.041	2.560	305
969.637	0.020	331	969.710	0.100	332	969.905	0.170	337	969.972	0.129	339	973.045	5.000	305
969.638	0.020	331	969.711	0.100	332	969.906	0.170	337	969.973	0.128	339	973.046	6.100	305
969.639	0.020	331	969.712	0.100	332	969.907	0.170	337	969.974	0.128	339	973.047	6.100	305
969.640	0.020	331	969.713	0.090	332	969.908	0.170	337	969.975	0.129	339	973.052	0.850	302
969.641	0.020	331	969.714	0.090	332	969.909	0.168	337	969.981	0.002	337	973.053	1.380	302
969.643	0.040	331	969.715	0.090	332	969.910	0.169	337	969.982	0.002	337	973.054	2.000	302
969.644	0.050	331	969.716	0.090	332	969.911	0.169	337	969.983	0.002	337	973.055	0.950	302
969.645	0.050	331	969.717	0.080	332	969.912	0.163	337	969.984	0.005	337	973.056	1.998	302
969.646	0.040	331	969.718	0.080	332	969.913	0.164	337	969.985	0.004	337	973.057	2.600	302
969.647	0.040	331	969.719	0.080	332	969.914	0.164	337	969.986	0.005	337	973.058	3.320	302
969.648	0.040	331	969.720	0.080	332	969.915	0.163	337	969.987	0.004	337	973.059	4.280	302
969.649	0.040	331	969.721	0.070	332	969.921	0.020	338	969.988	0.010	337	973.060	2.100	302
969.650	0.040	331	969.722	0.070	332	969.922	0.020	338	969.989	0.006	337	973.061	3.720	302
969.651	0.040	331	969.723	0.068	332	969.923	0.020	338	969.990	0.005	337	973.062	4.750	302
969.652	0.010	331	969.724	0.060	332	969.924	0.036	338	969.991	0.001	337	973.063	5.700	302
969.653	0.040	331	969.725	0.060	332	969.925	0.036	338	969.992	0.010	337	973.064	0.240	285
969.654	0.040	331	969.726	0.060	332	969.926	0.037	338	969.993	0.010	337	973.065	0.700	285
969.655	0.040	331	969.727	0.050	332	969.927	0.035	338	969.994	0.002	337	973.066	0.240	285
969.656	0.040	331	969.861	0.030	336	969.928	0.035	338	969.995	0.002	337	973.067	0.240	285
969.657	0.040	331	969.862	0.030	336	969.929	0.054	338	969.996	0.002	337	973.068	0.300	285
969.658	0.030	331	969.863	0.030	336	969.930	0.054	338	969.997	0.010	337	973.069	0.300	285
969.659	0.030	331	969.864	0.050	336	969.931	0.054	338	972.304	0.005	578	973.070	0.210	285
969.660	0.030	331	969.865	0.050	336	969.932	0.054	338	972.306	0.005	578	973.071	0.210	285
969.661	0.030	331	969.866	0.050	336	969.933	0.054	338	972.309	0.003	578	973.072	0.245	285
969.662	0.030	331	969.867	0.040	336	969.934	0.052	338	972.310	0.003	578	973.073	0.245	285
969.663	0.030	331	969.868	0.040	336	969.935	0.052	338	972.311	0.003	578	973.076	0.338	285
969.669	0.080	332	969.869	0.070	336	969.936	0.080	338	972.321	0.012	349	973.077	0.700	285
969.670	0.080	332	969.870	0.070	336	969.937	0.080	338	972.322	0.029	349	973.078	0.400	285
969.671	0.080	332	969.871	0.070	336	969.938	0.083	338	972.331	0.950	369	973.079	0.400	285
969.672	0.080	332	969.872	0.070	336	969.939	0.083	338	973.001	0.550	300	973.080	0.330	285
969.673	0.080	332	969.873	0.070	336	969.940	0.083	338	973.002	0.761	300	973.081	0.700	285

List with Order Numbers and Weights

Order No.	Weight (kg)	Page	Order No.	Weight (kg)	Page	Order No.	Weight (kg)	Page	Order No.	Weight (kg)	Page	Order No.	Weight (kg)	Page
973.082	0.380	285	973.208	0.450	231	973.274	1.400	233	973.359	2.100	235	973.576	1.150	247
973.083	0.700	285	973.209	0.468	231	973.275	1.580	233	973.360	1.300	235	973.577	0.990	247
973.084	0.406	285	973.210	0.782	231	973.276	2.200	233	973.361	1.020	235	973.578	2.600	247
973.085	0.700	285	973.211	0.801	231	973.277	1.040	233	973.362	1.140	235	973.579	2.800	247
973.086	0.258	285	973.212	0.800	231	973.278	1.120	233	973.363	1.280	235	973.580	2.420	247
973.087	0.276	285	973.213	0.500	232	973.279	1.260	233	973.364	1.800	235	973.598	1.000	105
973.088	0.700	306	973.214	0.400	232	973.280	1.400	233	973.365	1.900	235	973.600	1.200	105
973.089	0.700	306	973.215	0.560	232	973.281	1.520	233	973.366	2.400	235	973.601	1.700	105
973.090	0.700	306	973.216	0.600	232	973.282	1.650	233	973.367	1.400	235	973.602	3.600	105
973.091	0.800	306	973.217	0.600	232	973.283	2.400	233	973.368	1.500	235	973.603	3.600	105
973.092	0.970	306	973.218	0.530	232	973.284	2.700	233	973.369	1.250	235	973.604	3.500	105
973.093	1.300	306	973.219	0.500	232	973.285	1.140	233	973.370	1.800	235	973.605	3.620	105
973.094	1.500	306	973.220	0.630	232	973.286	1.180	233	973.371	2.000	235	973.609	1.017	524
973.095	2.000	306	973.221	0.600	232	973.287	1.340	233	973.372	2.200	235	973.680	2.500	239
973.096	3.700	306	973.222	0.700	232	973.288	1.500	233	973.373	2.700	235	973.682	4.700	239
973.097	1.000	306	973.223	0.550	232	973.289	1.640	233	973.374	1.120	236	973.684	3.500	239
973.098	1.000	306	973.224	0.650	232	973.290	2.300	233	973.375	1.600	236	973.686	3.650	239
973.099	1.000	306	973.225	0.720	232	973.291	2.600	233	973.376	1.440	236	973.688	3.550	239
973.100	1.100	306	973.226	0.500	232	973.292	2.900	233	973.377	1.660	236	973.690	4.780	239
973.101	1.280	306	973.227	0.500	232	973.293	1.860	234	973.378	1.900	236	973.710	1.500	242
973.102	1.580	306	973.229	0.580	232	973.295	1.900	234	973.379	2.600	236	973.711	1.400	242
973.103	1.840	306	973.230	0.710	232	973.297	2.020	234	973.380	2.800	236	973.712	1.200	242
973.104	2.350	306	973.231	0.800	232	973.298	2.600	234	973.382	2.600	236	973.713	1.600	242
973.105	3.720	306	973.232	0.500	232	973.300	2.700	234	973.385	2.300	236	973.714	1.400	242
973.110	2.000	307	973.233	0.600	232	973.302	2.200	234	973.388	2.700	236	973.715	1.300	242
973.111	3.300	307	973.235	0.700	232	973.304	2.010	234	973.391	3.200	236	973.716	1.500	242
973.112	2.820	307	973.236	0.800	232	973.306	2.140	234	973.394	2.150	236	973.718	1.000	244
973.113	3.320	307	973.237	0.930	232	973.308	2.380	234	973.396	3.200	236	973.720	1.180	244
973.114	4.400	307	973.238	0.600	232	973.311	2.040	234	973.397	2.680	236	973.721	1.110	244
973.115	0.880	245	973.239	0.600	232	973.313	2.220	234	973.400	2.300	236	973.722	1.800	244
973.116	0.840	245	973.241	0.710	232	973.315	3.200	234	973.402	2.750	236	973.723	2.200	244
973.117	0.940	245	973.242	0.800	232	973.316	2.700	234	973.403	3.400	236	973.724	1.800	244
973.119	1.700	245	973.243	1.000	232	973.318	2.160	234	973.404	4.300	236	973.725	2.100	244
973.120	1.260	245	973.244	0.600	232	973.320	2.420	234	973.465	2.180	238	973.726	2.300	244
973.121	1.180	245	973.245	0.600	232	973.322	2.800	234	973.466	2.920	238	973.727	2.900	244
973.122	1.580	245	973.247	0.820	233	973.325	2.220	234	973.467	3.550	238	973.728	3.500	244
973.123	1.780	245	973.248	0.860	233	973.327	2.520	234	973.469	2.570	238	973.729	4.100	244
973.124	2.200	245	973.249	0.890	233	973.329	3.040	234	973.471	3.000	238	973.730	3.200	244
973.125	2.200	245	973.250	1.300	233	973.330	3.410	234	973.472	5.200	238	973.731	3.450	244
973.126	2.100	245	973.251	0.950	233	973.331	0.500	235	973.473	2.700	238	973.732	5.200	244
973.127	2.580	245	973.252	1.200	233	973.333	0.700	235	973.475	4.740	238	973.737	2.800	585
973.128	2.660	245	973.253	1.070	233	973.334	0.800	235	973.476	5.780	238	973.738	3.770	585
973.181	0.012	286	973.254	0.850	233	973.335	0.900	235	973.477	3.350	238	973.739	3.820	585
973.182	0.012	286	973.255	1.300	233	973.336	0.600	235	973.478	3.940	238	973.740	4.840	585
973.183	0.012	286	973.256	0.970	233	973.338	0.800	235	973.479	5.240	238	973.751	1.635	301
973.184	0.008	286	973.257	1.000	233	973.339	1.000	235	973.480	6.500	238	973.752	1.352	301
973.185	0.011	286	973.258	1.060	233	973.340	1.100	235	973.553	1.200	242	973.753	2.600	305
973.186	0.017	286	973.259	1.100	233	973.341	0.600	235	973.554	1.300	242	973.754	1.110	248
973.187	0.013	286	973.260	1.200	233	973.343	0.900	235	973.555	1.300	242	973.755	1.180	248
973.188	0.017	286	973.261	0.890	233	973.344	1.100	235	973.556	1.400	242	973.756	1.722	248
973.194	0.007	371	973.262	1.400	233	973.345	1.300	235	973.557	1.400	242	973.954	0.270	230
973.195	0.015	371	973.263	1.040	233	973.347	0.760	235	973.558	2.100	242	973.955	0.290	230
973.196	0.011	371	973.264	1.110	233	973.348	0.900	235	973.559	1.500	242	974.006	1.300	292
973.197	0.015	371	973.265	1.180	233	973.349	1.080	235	973.560	2.500	242	974.028	2.700	294
973.198	0.020	371	973.266	1.250	233	973.350	1.300	235	973.562	1.800	246	974.056	1.800	293
973.201	0.530	230	973.267	1.380	233	973.351	1.400	235	973.563	1.900	246	974.057	2.400	293
973.202	1.040	230	973.268	2.000	233	973.353	1.200	235	973.564	2.900	246	974.100	1.050	296
973.203	0.580	230	973.269	0.930	233	973.354	0.950	235	973.565	3.500	246	974.102	1.540	296
973.204	0.890	230	973.270	1.050	233	973.355	1.040	235	973.572	0.660	247	978.001	0.418	90
973.205	0.940	230	973.271	1.120	233	973.356	1.140	235	973.573	0.900	247	978.002	0.445	90
973.206	0.960	230	973.272	0.900	233	973.357	1.280	235	973.574	1.200	247	978.003	0.479	90
973.207	0.000	231	973.273	1.300	233	973.358	1.800	235	973.575	0.990	247	978.004	0.530	90

List with Order Numbers and Weights

Order No.	Weight (kg)	Page	Order No.	Weight (kg)	Page	Order No.	Weight (kg)	Page	Order No.	Weight (kg)	Page	Order No.	Weight (kg)	Page
978.005	0.520	90	978.109	3.680	90	978.199	1.040	224	978.325	1.540	201	978.833	0.004	528
978.006	0.555	90	978.111	3.700	90	978.201	0.410	232	978.326	0.513	96	978.834	0.004	528
978.007	0.550	88	978.113	3.740	90	978.202	0.470	232	978.330	1.320	363	978.835	0.004	528
978.010	0.790	170	978.114	4.180	90	978.203	0.700	232	978.331	1.600	363	978.836	0.004	528
978.011	0.962	172	978.115	3.840	90	978.204	0.800	232	978.334	0.400	232	978.837	0.004	528
978.017	5.020	102	978.119	4.340	584	978.205	1.060	88	978.335	0.500	232	978.838	0.004	528
978.018	6.450	102	978.120	3.780	194	978.207	0.780	60	978.336	1.240	551	978.839	0.004	528
978.020	1.100	188	978.121	4.410	194	978.208	2.355	96	978.338	0.930	551	978.898	0.004	370
978.021	1.100	188	978.123	1.260	224	978.215	1.000	224	978.339	1.300	551	978.899	0.004	370
978.022	1.300	188	978.124	1.340	224	978.219	1.420	96	978.341	4.000	97	978.900	0.005	370
978.023	1.500	188	978.128	2.390	96	978.222	3.900	585	978.343	1.300	83	978.901	0.015	370
978.024	1.600	188	978.129	3.840	97	978.226	4.940	147	978.356	0.172	274	978.902	0.012	370
978.025	0.735	82	978.130	4.480	97	978.236	4.220	582	978.357	1.500	271	978.903	0.027	370
978.027	1.340	83	978.131	5.060	97	978.237	1.600	582	978.367	1.120	88	978.904	0.043	370
978.028	1.360	83	978.132	4.160	97	978.238	2.600	582	978.368	1.400	96	978.905	0.070	370
978.029	8.180	97	978.133	6.610	97	978.239	0.650	167	978.370	0.171	164	978.907	0.009	228
978.030	0.723	68	978.134	1.040	230	978.248	3.200	288	978.372	0.180	164	978.908	0.013	569
978.031	0.586	167	978.135	1.270	296	978.252	1.840	289	978.378	2.600	96	978.909	0.006	228
978.034	0.645	82	978.136	1.160	88	978.253	1.350	584	978.379	0.181	353	978.910	0.026	228
978.035	2.380	96	978.137	1.220	88	978.254	0.499	104	978.399	1.005	104	978.911	0.130	228
978.037	1.675	368	978.138	1.240	88	978.255	0.680	104	978.400	1.170	104	978.912	0.002	366
978.038	0.805	82	978.139	1.380	88	978.256	0.002	568	978.402	1.180	186	978.913	0.010	228
978.046	1.160	83	978.141	8.150	97	978.259	0.725	96	978.403	4.060	97	978.914	0.024	366
978.047	1.040	224	978.142	7.800	97	978.261	0.705	167	978.404	1.500	186	978.915	0.024	334
978.056	1.020	90	978.143	9.920	97	978.262	1.300	167	978.406	0.900	271	978.916	0.024	334
978.057	1.060	90	978.145	1.240	96	978.273	0.902	96	978.407	7.660	288	978.917	0.024	334
978.058	1.132	90	978.146	0.920	224	978.274	0.474	104	978.413	0.700	271	978.918	0.010	553
978.059	1.150	90	978.147	1.200	224	978.275	7.700	543	978.476	1.360	304	978.921	0.005	228
978.060	1.170	90	978.148	5.700	97	978.276	0.378	542	978.499	0.008	327	978.951	0.027	374
978.061	1.252	90	978.149	4.430	97	978.277	1.200	542	978.500	0.009	327	978.953	0.029	374
978.071	0.580	82	978.150	4.450	372	978.278	0.001	542	978.501	0.074	348	978.954	0.071	374
978.072	0.700	82	978.151	1.120	224	978.279S	1.960	74	978.504	0.167	337	978.955	0.070	374
978.073	0.781	82	978.152	1.060	224	978.280	2.820	87	978.505	0.009	327	978.956	0.028	374
978.074	0.700	82	978.160	1.540	287	978.281	4.200	87	978.506	0.010	327	978.958	0.082	374
978.075	0.578	82	978.161	2.740	288	978.283	0.002	553	978.507	0.008	327	978.965	0.275	375
978.076	0.652	82	978.162	2.300	287	978.284	0.006	503	978.508	0.075	327	978.966	0.214	375
978.077	0.800	82	978.164	0.980	104	978.285	3.360	288	978.509	0.022	327	978.967	0.277	375
978.078	0.810	82	978.165	1.360	104	978.286	0.180	359	978.511	0.008	326	978.971	0.068	374
978.079	0.700	82	978.167	5.040	97	978.287	0.179	359	978.512	0.170	337	978.972	0.025	374
978.080	0.566	82	978.168	5.600	97	978.288	0.177	359	978.513	0.008	326	978.975	0.070	374
978.081	0.764	82	978.170	0.670	170	978.289	0.172	359	978.516	0.010	326	978.976	0.263	576
978.082	0.800	82	978.173	1.400	86	978.290	7.150	584	978.517	0.009	326	978.977	0.070	374
978.083	0.876	82	978.174	4.730	97	978.291	0.990	90	978.518	0.099	336	978.978	0.030	374
978.084	0.800	82	978.175	6.040	97	978.292	1.188	289	978.801	0.002	528	978.979	0.030	374
978.085	0.620	82	978.178	1.100	585	978.293	1.546	289	978.803	0.003	528	979.010	0.235	166
978.086	0.710	82	978.179	0.449	88	978.294	6.450	102	978.804	0.001	528	979.140	1.600	585
978.087	0.800	82	978.180	0.480	88	978.295	0.900	190	978.807	0.002	528	979.194	0.873	194
978.088	0.940	82	978.181S	1.340	74	978.296	0.800	190	978.809	0.002	528	979.196	1.880	194
978.089	0.800	82	978.183	12.760	97	978.297	0.918	190	978.810	0.002	528	979.198	0.900	296
978.090	0.900	82	978.184	0.779	68	978.298	0.933	190	978.811	0.002	528	979.199	0.890	296
978.091	0.900	82	978.185	1.380	194	978.299	0.966	190	978.812	0.002	528	979.202	1.200	186
978.092	0.512	82	978.186	1.600	194	978.307	0.450	585	978.813	0.003	528	979.203	1.260	186
978.093	0.900	82	978.187	0.800	66	978.310	0.483	165	978.814	0.003	528	979.204	1.280	186
978.094	0.900	82	978.188	0.800	66	978.313	0.616	542	978.817	0.009	553	979.206	1.480	186
978.095	0.736	82	978.189	0.840	224	978.314	0.950	101	978.820	0.001	542	979.976	0.006	366
978.096	1.000	82	978.190	0.890	224	978.315	0.930	101	978.821	0.005	528	979.980	0.136	352
978.097	1.520	82	978.192	1.340	83	978.317	2.320	101	978.826	0.042	553	979.986	0.070	336
978.098	1.800	82	978.193	1.400	83	978.318	2.380	101	978.827	0.002	528	979.987	0.068	336
978.100	0.440	217	978.194	1.420	83	978.319	2.120	289	978.828	0.004	528	979.995	0.070	371
978.102	0.980	224	978.195	1.040	224	978.320	2.760	289	978.829	0.004	528	979.996	0.070	371
978.104	0.226	165	978.196	0.350	232	978.321	4.360	289	978.830	0.004	528	979.997	0.070	371
978.105	3.580	90	978.197	0.700	232	978.323	1.347	289	978.831	0.004	528	979.998	0.070	371
978.107	3.630	90	978.198	1.900	585	978.324	1.440	96	978.832	0.004	528			

