

UNION TOOL

Tungsten Carbide End Mills UNIMAX Series · V Series Vol.21



1 Flute

2 Flutes

3 Flutes

4 Flutes

5 Flutes

6 Flutes

10 Flutes

Ø3mm Shank
V Series

UDC-PCD
Series

CBN
Series

Square
Long Neck
Square

Radius

Radius
Long Neck
Radius

Taper Neck
Radius

Ball / Long
Shank Ball

Ball
Long Neck
Ball

Taper Neck
Ball

Taper
Taper

Barrel

Spiral
V Cutter

Drill

Technical Data



UNION TOOL CO.

UNIMAX End Mills Tool Finder

- Our catalogue PDF data and DXF files can be downloaded.
- Products that meet your needs can be searched by tool types, sizes, series names and work materials.

▼ View from here ▼

For smart devices



For computers

UNIMAX end mill tool finder

Search



TOOL T N N N

- 1 Flute
- 2 Flutes
- 3 Flutes
- 4 Flutes
- 5 Flutes
- 6 Flutes
- 10 Flutes

● ϕ 3mm Shank V Series / 32-58

● For Cemented Carbide UDC·PCD / 60-116



● CBN Series / 118-151

● Square / 152-241



● Long Neck Square / 242-301



● Radius / 302-323

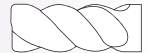

● Long Neck Radius / 324-411

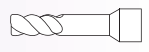

● Taper Neck Radius / 412-421



● Ball / Long Shank Ball / 422-459



● Long Neck Ball / 460-535



● Taper Neck Ball / 536-563



● Taper / 564-571



● Barrel / 572-577



● Spiral V Cutter / 578-579

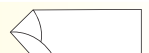

● Drill / 580-601



● Technical Data / 602-608

1 Flute

2 Flutes

3 Flutes

4 Flutes

5 Flutes

6 Flutes

10 Flutes

ϕ 3mm Shank
V Series

UDC·PCD
Series

CBN
Series

Square

Long Neck
Square

Radius

Long Neck
Radius

Taper Neck
Radius

Ball / Long
Shank Ball

Long Neck
Ball

Taper Neck
Ball

Taper

Barrel

Spiral
V Cutter

Drill

Technical Data

Index

Alphabetical Order

Model Number	Page	Characteristic
A		
AZS	278	3 Flute Long Neck Square
C		
CAS	192	2 Flute Square
CBN-LBF	126	2 Flute CBN Long Neck Ball
CBN-LBSF	122	2 Flute CBN Long Neck Ball
CBN-LRF2000	136	2 Flute CBN Long Neck Radius
CBN-LRF4000	146	4 Flute CBN Long Neck Radius
CBN-PLB	120	2 Flute CBN Long Neck Ball
CBN-RSF	132	1 Flute CBN Long Neck Radius
CESUS	228	4 Flute Square
CFB	442	3 Flute Ball
CFLB	530	3 Flute Long Neck Ball
GGB2000	440	2 Flute Ball
GGB4000	458	4 Flute Ball
CGE	236	4 Flute Square
CNRS	306	4 Flute Radius
COVB	572	4 Flute Oval Barrel Form
CPR	270	2 Flute Long Neck Square
CPRB	526	2 Flute Long Neck Ball
CPRL	274	2 Flute Long Neck Square (Long Shank)
CPS	190	2 Flute Square
CRN-ES2000	186	2 Flute Square
CRN-ES4000	232	4 Flute Square
CRRS	390	4 Flute Long Neck Radius
CSTB	574	4 Flute Standard Taper Barrel Form
CWTB	576	4 Flute Wide Taper Barrel Form
CSEB	432	2 Flute Ball (R0.05/0.2 Length of Cut: Single Flute)

Model Number	Page	Characteristic
CSELB	496	2 Flute Long Neck Ball for Deep Rib Milling
CSS	152	2 Flute Square
CXERS	310	4 Flute Radius
CXES	216	4 Flute Square
CXLRS	400	5 Flute Long Neck Radius
CXRS	316	5 Flute Radius
CXS	294	4 Flute Long Neck Square
CZS	202	4 Flute Square
C-CER	256	2 Flute Long Neck Square for Deep Rib Milling
C-CES2000	166	2 Flute Square
C-CES2000S	180	2 Flute Square (Sharp Corner)
C-CES4000	194	4 Flute Square
C-CES4000S	200	4 Flute Square (Sharp Corner)
C-CRS	302	2 Flute Radius
C-CTE2000	564	2 Flute Taper
C-CTE4000	568	4 Flute Taper
C-UMD	588	2 Flute UNIMAX Drill
D		
DCB	438	2 Flute Ball
DCES2000	188	2 Flute Square
DCES4000	234	4 Flute Square
DCLB	512	2 Flute Long Neck Ball
DCLRS	396	4 Flute Long Neck Radius
DCLS	266	2 Flute Long Neck Square
DCTNB	556	2 Flute Taper Neck Ball
DLC-AZS	282	3 Flute Long Neck Square
DLC-CFB	448	3 Flute Ball
DLCLB	516	2 Flute Long Neck Ball

Index

Alphabetical Order

Model Number	Page	Characteristic
H		
HBL	430	2 Flute Ball (Long Shank)
HFB	452	4 Flute Ball
HFB-S	453	4 Flute Ball (Short Shank)
HFTNB	558	3 Flute Taper Neck Ball
HGB	422	2 Flute Ball
HGLB	460	2 Flute Long Neck Ball
HGLRS	344	4 Flute Long Neck Radius
HGRRS	408	5 Flute / 6 Flute Long Neck Radius
HHRS	404	4 Flute / 6 Flute Long Neck Radius
HLRS2000	324	2 Flute Long Neck Radius
HLRS4000	358	4 Flute Long Neck Radius
HLRS2000E	324	2 Flute Long Neck Radius (High Radius Accuracy)
HLS2000	242	2 Flute Long Neck Square
HLS4000	288	4 Flute Long Neck Square
HMERS	320	4 Flute / 6 Flute Radius
HMS	238	3-6 Flute Square
HRRS	382	4 Flute Long Neck Radius
HRRS-S	388	4 Flute Long Neck Radius (Short Shank)
HSB	424	2 Flute Ball (R0.05: Single Flute)
HSB-S	428	2 Flute Ball (Short Shank)
HSLB	476	2 Flute Long Neck Ball
HSLB-S	492	2 Flute Long Neck Ball (Short Shank)
HTNB	536	2 Flute Taper Neck Ball
HTNRS	412	4 Flute Taper Neck Radius
HWLB	470	2 Flute Long Neck Ball
S		
SV	578	2 Flute Spiral Chamfering Cutter

Model Number	Page	Characteristic
P		
PMD STD	598	P Series Non-coat Drill
PMD PLT	599	P Series Non-coat Drill for Pilot Hole Drilling
PSM	599	P Series Gun Barrel Drill
U		
UDCB	72	2 Flute Ball
UDCBF	70	2 Flute Ball
UDCBH	68	2 Flute Ball
UDCLB	84	2 Flute Long Neck Ball
UDCLBF	80	2 Flute Long Neck Ball
UDCLBH	76	2 Flute Long Neck Ball
UDCLRS	98	2 Flute Long Neck Radius
UDCLRSF	90	2 Flute Long Neck Radius
UDCMX	110	2 Flute Drill
UDCRRS	104	6 Flute / 10 Flute Long Neck Radius
UDCT	114	2 Flute Thread Mill
UPDLB	88	1 Flute Long Neck Ball
UPDLRS	108	1 Flute Long Neck Radius
UTDF	580	2 Flute UNIMAX Flat Drill
UTDLX	594	2 Flute UNIMAX Drill (Long Flute)
UTDSX	586	2 Flute UNIMAX Drill (Short Flute)
V		
VCSELB	44	2 Flute Long Neck Ball (Short Shank)
VDLCLB	48	2 Flute Long Neck Ball (Short Shank)
VHGLB	34	2 Flute Long Neck Ball (Short Shank)
VHLRS	55	2 Flute Long Neck Radius (Short Shank)
VHLS	52	2 Flute Long Neck Square (Short Shank)
VHSLB	37	2 Flute Long Neck Ball (Short Shank)

How to find your tool

Cover page



Search by number of flutes or shape from index



INDEX

Search by end geometry

P.12~23

P.24~29

Search by series name

To the main description

INDEX

5 Flutes UTICOAT

Size: 04.1~012

CSS (MIG, CoCr, CoTi, CoNi, CoAl, CoSi)

Material Applications: **Highly Recommended** (Steel, Inconel, Ti, Al, Cu) **Recommended** (Stainless Steel, Nickel Alloys, Ti Alloys) **Suggested** (Aluminum, Magnesium, Brass, Copper)

Unique Cross Section design

Flute shape: Conventional, CSS (New flute shape with higher rigidity and better chip evacuation, larger cross section area than conventional design)

Cross section: The flank taper angle shown is not an exact value but the exact angle and the exact shape are recommended that are specified for precise data of the single flute. Flank taper angle should be taken contact with the each piece.

Model Number	Diameter ØD	Length of Cut	Flank Taper Angle (°)	Flute Depth	Depth of Cut	Lead (mm)	
						Lead 1	Lead 2
CSS 200-0401	4.0	4.0	10°	1.0	2.0	2.0	1.0
CSS 200-0402	4.0	6.0	10°	1.0	2.0	2.0	1.0
CSS 200-0403	4.0	8.0	10°	1.0	2.0	2.0	1.0
CSS 200-0404	4.0	10.0	10°	1.0	2.0	2.0	1.0
CSS 200-0405	4.0	12.0	10°	1.0	2.0	2.0	1.0
CSS 200-0406	4.0	14.0	10°	1.0	2.0	2.0	1.0
CSS 200-0407	4.0	16.0	10°	1.0	2.0	2.0	1.0
CSS 200-0408	4.0	18.0	10°	1.0	2.0	2.0	1.0
CSS 200-0409	4.0	20.0	10°	1.0	2.0	2.0	1.0
CSS 200-0410	4.0	22.0	10°	1.0	2.0	2.0	1.0
CSS 200-0411	4.0	24.0	10°	1.0	2.0	2.0	1.0
CSS 200-0412	4.0	26.0	10°	1.0	2.0	2.0	1.0
CSS 200-0413	4.0	28.0	10°	1.0	2.0	2.0	1.0
CSS 200-0414	4.0	30.0	10°	1.0	2.0	2.0	1.0
CSS 200-0415	4.0	32.0	10°	1.0	2.0	2.0	1.0
CSS 200-0416	4.0	34.0	10°	1.0	2.0	2.0	1.0
CSS 200-0417	4.0	36.0	10°	1.0	2.0	2.0	1.0
CSS 200-0418	4.0	38.0	10°	1.0	2.0	2.0	1.0
CSS 200-0419	4.0	40.0	10°	1.0	2.0	2.0	1.0
CSS 200-0420	4.0	42.0	10°	1.0	2.0	2.0	1.0
CSS 200-0421	4.0	44.0	10°	1.0	2.0	2.0	1.0
CSS 200-0422	4.0	46.0	10°	1.0	2.0	2.0	1.0
CSS 200-0423	4.0	48.0	10°	1.0	2.0	2.0	1.0
CSS 200-0424	4.0	50.0	10°	1.0	2.0	2.0	1.0
CSS 200-0425	4.0	52.0	10°	1.0	2.0	2.0	1.0
CSS 200-0426	4.0	54.0	10°	1.0	2.0	2.0	1.0
CSS 200-0427	4.0	56.0	10°	1.0	2.0	2.0	1.0
CSS 200-0428	4.0	58.0	10°	1.0	2.0	2.0	1.0
CSS 200-0429	4.0	60.0	10°	1.0	2.0	2.0	1.0
CSS 200-0430	4.0	62.0	10°	1.0	2.0	2.0	1.0
CSS 200-0431	4.0	64.0	10°	1.0	2.0	2.0	1.0
CSS 200-0432	4.0	66.0	10°	1.0	2.0	2.0	1.0
CSS 200-0433	4.0	68.0	10°	1.0	2.0	2.0	1.0
CSS 200-0434	4.0	70.0	10°	1.0	2.0	2.0	1.0
CSS 200-0435	4.0	72.0	10°	1.0	2.0	2.0	1.0
CSS 200-0436	4.0	74.0	10°	1.0	2.0	2.0	1.0
CSS 200-0437	4.0	76.0	10°	1.0	2.0	2.0	1.0
CSS 200-0438	4.0	78.0	10°	1.0	2.0	2.0	1.0
CSS 200-0439	4.0	80.0	10°	1.0	2.0	2.0	1.0
CSS 200-0440	4.0	82.0	10°	1.0	2.0	2.0	1.0
CSS 200-0441	4.0	84.0	10°	1.0	2.0	2.0	1.0
CSS 200-0442	4.0	86.0	10°	1.0	2.0	2.0	1.0
CSS 200-0443	4.0	88.0	10°	1.0	2.0	2.0	1.0
CSS 200-0444	4.0	90.0	10°	1.0	2.0	2.0	1.0
CSS 200-0445	4.0	92.0	10°	1.0	2.0	2.0	1.0
CSS 200-0446	4.0	94.0	10°	1.0	2.0	2.0	1.0
CSS 200-0447	4.0	96.0	10°	1.0	2.0	2.0	1.0
CSS 200-0448	4.0	98.0	10°	1.0	2.0	2.0	1.0
CSS 200-0449	4.0	100.0	10°	1.0	2.0	2.0	1.0
CSS 200-0450	4.0	102.0	10°	1.0	2.0	2.0	1.0

Total 112 models

INDEX

Icon Guide Lines

unit : mm







Tool Material

 Super MG Super Micro Grain	 CBN CBN
 MG Micro Grain	 Binderless PCD Binderless PCD



Coating

 HMG COAT HMGCOAT	 UTS COAT UTSCOAT
 HMW COAT HMWCOAT	 CrN COAT CrN COAT
 HARD MAX HARDMAX	 UDC UDC
 UT COAT UTCOAT	 DIA DIA
 MICRO COAT UT MICRO COAT	 DLC DLC







Geometry

 Corner Radius Design	 Back Taper Geometry
 Sharp Corner Design	 Variable Pitch
 Flatland Design	 Variable Helix
 X Thinning Design	

Shank Diameter Tolerance

 Shank Dia 0/-0.003 Tolerance of Shank Diameter : 0/-0.003	 Shank Dia 0/-0.004 Tolerance of Shank Diameter : 0/-0.004
 Shank Dia 0/-0.005 Tolerance of Shank Diameter : 0/-0.005	



Ball Radius Tolerance

 Ball Radius Tolerance : ±0.002	 Ball Radius Tolerance : ±0.005
 Ball Radius Tolerance : ±0.003	 Ball Radius Tolerance : ±0.007
 Ball Radius Tolerance : ±0.004	 Ball Radius Tolerance : ±0.01

Form Tolerance

 Form Form Tolerance
--

Corner Radius Tolerance

 Corner Radius Tolerance : ±0.002	 Corner Radius Tolerance : ±0.01
 Corner Radius Tolerance : ±0.003	 Corner Radius Tolerance : ±0.015
 Corner Radius Tolerance : ±0.005	 Corner Radius Tolerance : ±0.02

Half Included Angle Tolerance

 Half Included Angle Tolerance : ±5'

Helix Angle

 Helix Angle 0°	 Helix Angle 42°~45°
 Helix Angle 20°	 Helix Angle 45°
 Helix Angle 24°	 Helix Angle 0°
 Helix Angle 25°	 Helix Angle 20°
 Helix Angle 30°	 Helix Angle 30°
 Helix Angle 37°~40°	 Helix Angle 35°
 Helix Angle 40°	 Helix Angle 40°
 Helix Angle 40°~42°	

Features of Coating

★Highly Recommended ●Recommended ○Suggested △Satisfactory

Coating Series			Hardness (HV)	Heat Resistance	Toughness	Lubricant Efficiency	Recommended Use
Ceramics based	HMGCOAT		3700~4200	★	○	●	For Steels
	HMWCOAT		3700~4000	★	●	●	
	HARDMAX		3500~4000	★	○	●	
	UTCOAT		3000~3500	●	●	★	For Copper / Raw Materials up to 55HRC
	UTSCOAT		3000~3500	●	●	★	For Stainless Steels
	CrN		2000~2200	○	●	★	For Copper
DLC	DLC		4000~6000	△	△	★	For Copper / Aluminum / Plastics
Diamond	DIA		around 9000	△	△	●	For Graphite
	UDC		around 9000	△	○	●	For Cemented Carbide / Hard Brittle Materials

How to find best coating for your material applications

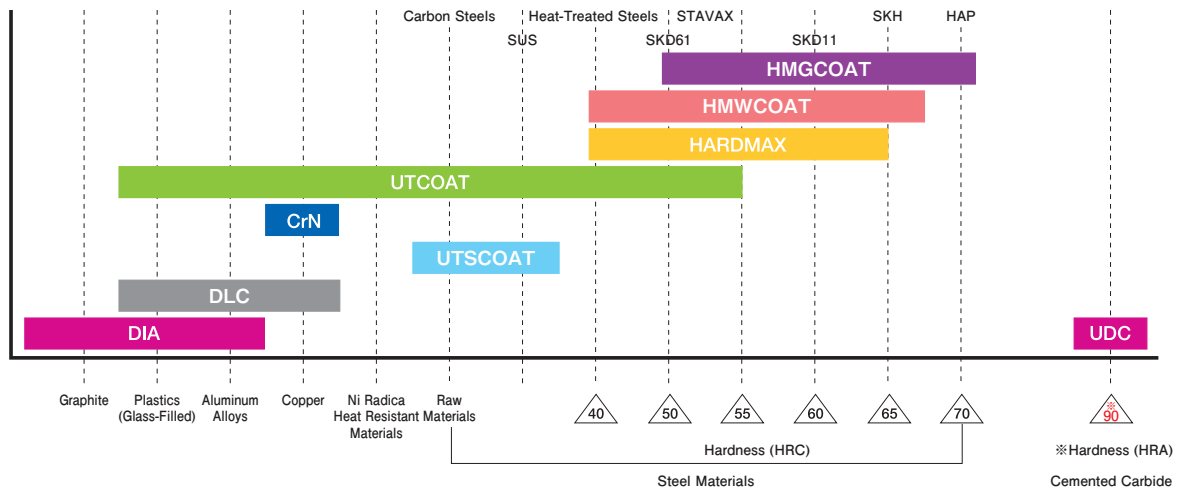



Advisory for Safe Use of End Mills

Correct application and operation is strongly advised to avoid clogging, abrasion, etc, that could cause serious accidents or injuries.

Ignition or sparks generated during milling could lead to fire or extreme damage to the work piece.

End Mills are made with very sharp cutting edges and must be handled with extra care.

- Never touch the cutting edge with your bare hands, as this could cause serious injury. Special caution is required when opening the package.
- Dropping the tool could cause breakage or flying debris, leading to serious injury.
- During milling, unexpected impact or shock on the tool could cause breakage or flying debris. Ensure to use protective items such as safety glasses and a face guard.
- For best results, fine parameter adjustment may be required, depending on the materials; milling shape and strategy; machine rigidity and spindle capability.
- Use a machine that has high rigidity and generates a low level of vibration. Recommend setting the runout control value at $5\mu\text{m}$ or below for the small diameter tools $\phi 1$ or below.
- Do not use flammable cutting oils.

Advisory for Regrinding End Mills

- Never regrind the tool without wearing safety glasses and a face guard.

Value Series

Φ3 Shank × Overall length 38mm

VHGLB

For Hard Materials
2 Flutes Long Neck Ball



34

VDCLB

DLCCOAT for
Copper and Aluminum
2 Flutes Long Neck Ball

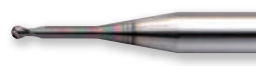

48

VHSLB

For Hard Materials
2 Flutes Long Neck Ball



37

VHLS

HARDMAX
2 Flutes Long Neck Square



52

VCSELB

For Raw Materials and up to 55HRC
2 Flutes Long Neck Ball



44

VHLRS

HARDMAX
2 Flutes Long Neck Radius



55

For Cemented Carbide / Hard Brittle Materials

UDC Series

UDCLBH

For higher efficiency
2 Flutes High-speed Long Neck Ball



76

UDCRRS

6 Flutes / 10 Flutes
High Efficiency Long Neck Radius



104

CBN Series

CBN-PLB

For Super Mirror Milling
2 Flutes Long Neck Ball



120

CBN-LRF4000

Long Tool Life
4 Flutes Long Neck Radius



146

HMWCOAT Series

HWLB

For Hard Materials
2 Flutes Long Neck Ball



470

NEW PRODUCTS

For Hard Materials HMGCOAT Series

HGRRS

High Efficiency for
Hard Materials
5 Flutes / 6 Flutes Long Neck Radius



408

HGLRS

For Hard Materials
4 Flutes Long Neck Radius



344

For Highly Efficient Finishing Barrel End Mills

COVB

4 Flutes Oval Barrel Form



572

CSTB

4 Flutes
Standard Taper Barrel Form



574

CWTB

4 Flutes
Wide Taper Barrel Form



576

ADDITIONAL MODELS

For Cemented Carbide / Hard Brittle Materials UDC Series

UDCBH

For higher efficiency
2 Flutes High-speed Ball



68

UDCBF

For better surface finish
2 Flutes High-grade Ball



70

UDCLRSF

For better surface finish
2 Flutes High-grade Long Neck Radius



90

CBN Series

CBN-LBF

Long Tool Life
2 Flutes Long Neck Ball



126

CBN-LRF2000

Long Tool Life
2 Flutes Long Neck Radius



136

For Hard Materials HARDMAX Series

HHR









4 Flutes / 6 Flutes
High-rigidity Long Neck Radius













404

Tool Chart

Square / Long Neck Square for Steel



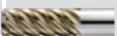



	Copper, Raw Materials	~40HRC	~50HRC	~60HRC	~70HRC
High efficiency			For Hard Materials 3~6 Flutes	HMS 	238
	4 Flutes Drillable Square	CZS 	202		
	4 Flutes Variable pitch and helix	CXES/CXS 	216 294		
Multi-purpose	4 Flutes for SUS Variable pitch and helix	CESUS 	228		
	2 Flutes Multi-purpose	CSS 	152		
Finishing	2 Flutes / 4 Flutes Multi-purpose	C-CES 2000/4000 	166 194		
	2 Flutes Long Neck Square · Tip design : Negative		2 Flutes / 4 Flutes Long Neck Square · Tip design : Negative	HLS 2000/4000 	242 288
	2 Flutes Long Neck Square · Tip design : Positive	C-CER 	256		



Radius / Long Neck Radius for Steel

	Copper, Raw Materials	~40HRC	~50HRC	~60HRC	~70HRC		
High efficiency			5 Flutes / 6 Flutes For bottom surface milling	HGRRS 	408		
	5 Flutes Variable pitch and helix	CXRS/CXLRS 	316 400				
	4 Flutes Variable pitch		4 Flutes Variable pitch	HRRS 	382		
	4 Flutes Variable pitch	CRRS 	390	4 Flutes Variable pitch and helix	CXERS 	310	
Multi-purpose	4 Flutes For difficult to cut materials	CNRS 	306	4 Flutes / 6 Flutes High-rigidity	HHRS 	404	
	2 Flutes Multi-purpose	C-CRS 	302		4 Flutes / 6 Flutes For high efficiency side milling	HMERS 	320
	2 Flutes / 4 Flutes For high-precision milling	HLRS 2000/4000 	324 358		4 Flutes For Hard Materials and high-precision milling	HGLRS 	344

Tool Chart

Ball / Long Neck Ball for Steel

	Copper, Raw Materials	~40HRC	~50HRC	~60HRC	~70HRC
Negative			2 Flutes For Hard Materials · Tip design : Negative	HGB/HGLB	  422 460
			2 Flutes For Hard Materials · Tip design : Negative	HWLB	 470
Tip design		2 Flutes For Hard Materials · Tip design : Negative	HSB/HSLB	  424 476	
Positive		2 Flutes Multi-purpose / For better surface finish · Tip design : Neutral	CSEB/CSELB	  432 496	

	Copper, Raw Materials	~40HRC	~50HRC	~60HRC	~70HRC
3 Flutes / 4 Flutes		3 Flutes · Tip design : Positive	CFB/CFLB	  442 530	
			4 Flutes · Tip design : Negative	HFB	 452

For Graphite		
Square	DCES2000 (All Flute / 2 Flutes)	188
	DCES4000 (All Flute / 4 Flutes)	234
	DCLS (Long Neck / 2 Flutes)	266
Radius	DCLRS (Long Neck / 4 Flutes)	396
Ball	DCB (All Flute / 2 Flutes)	438
	DCLB (Long Neck / 2 Flutes)	512
	DCTNB (Taper Neck / 2 Flutes)	556

For Copper		
Square	CRN-ES2000 (All Flute / 2 Flutes)	186
	CRN-ES4000 (All Flute / 4 Flutes)	232
Ball	DLCLB (Long Neck / 2 Flutes)	516
	VDLCLB (Long Neck / 2 Flutes)	48

For Heat Resistant Alloys		
Radius	CNRS (All Flute / 4 Flutes)	306
	CRRS (Long Neck / 4 Flutes)	390
Ball	CFB (All Flute / 3 Flutes)	442
	CFLB (Long Neck / 3 Flutes)	530

For Plastics		
Square	CPS (All Flute / 2 Flutes)	190
	CPR (Long Neck / 2 Flutes)	270
	CPRL (Long Neck / 2 Flutes)	274
Ball	CPRB (Long Neck / 2 Flutes)	526





For Aluminum Alloys		
Square (Finishing)	CAS (All Flute / 2 Flutes)	192
Square (Efficiency)	AZS/DLC-AZS (Long Neck / 3 Flutes)	278 282
	Ball	DLC-CFB (All Flute / 3 Flutes)

Tool Type



Number of Flute	Appearance	Model Number	Coating	Helix Angle	Features
-----------------	------------	--------------	---------	-------------	----------

Square

Square for Steels

2 Flutes		CSS	UT COAT	30° & 40°	Standard 2 flute square Length of cut L/D 1D, 2D, 2.5D, and 3D
2 Flutes		C-CES 2000	UT COAT	30°	Standard 2 flute square Length of cut L/D 1.5D, 2D, 2.5D, 3D, and 4D
2 Flutes		C-CES 2000S	UT COAT	30°	C-CES 2000 with sharp edge
4 Flutes		C-CES 4000	UT COAT	30°	Standard 4 flute square Length of cut L/D 2.5D, 3D, and 4D
4 Flutes		C-CES 4000S	UT COAT	30°	C-CES 4000 with sharp edge

High Efficiency

4 Flutes		CZS	UT COAT	40°	4 flute highly efficient square and enables vertical milling
4 Flutes		CXES	UT COAT	37° ~ 40°	4 flute highly efficient square with variable pitch and helix design Recommended for Raw Materials, SUS, Hardened Steels and etc

For Hard Materials

3-6 Flutes		HMS	HARD MAX	45°	3-6 flute square for Hard Materials Recommended for milling on 65HRC High Speed Steels
------------	---	------------	----------	-----	---





Square for Aluminum Milling

2 Flutes		CAS	—	45°	For Aluminum milling NON-COAT standard 2 flute square
----------	---	------------	---	-----	--

Square for Stainless Steel Milling

4 Flutes		CESUS	UTS COAT	40° ~ 42°	Special design for SUS milling 4 flute highly efficient square with variable pitch and helix design
----------	--	--------------	----------	-----------	--

Square for Copper Electrode Milling

2 Flutes		CRN-ES 2000	CrN COAT	20°	CrN COAT 2 flute square	Positive rake angle 
4 Flutes		CRN-ES 4000	CrN COAT	25°	CrN COAT 4 flute square	Positive rake angle 

Square for Plastic Milling

2 Flutes		CPS	—	30°	NON-COAT 2 flute square
----------	---	------------	---	-----	-------------------------

Square for Graphite Milling

2 Flutes		DCES 2000	DIA	30°	DIA COAT 2 flute square
4 Flutes		DCES 4000	DIA	30°	DIA COAT 4 flute square
4 Flutes		CGE	—	45°	NON-COAT 4 flute square

Model Number	Size	Carbon Steels	Alloy Steels SUS	Prehardened Steels	Hardened Steels					Cast Iron	Aluminum Alloys	Graphite	Copper	Plastics	Glass Filled Plastics	Titanium Alloys	Heat Resistant Alloys	Cemented Carbide	Hard Brake (Non-Metallic) Materials	Page
					50 HRC	55 HRC	60 HRC	65 HRC	70 HRC											

Square

For Steels

CSS	φ0.1 ~ φ12	●	●	●	●	●					○	○		●			○	○			152
C-CES 2000	φ0.1 ~ φ20	●	●	●	●	○					○			●			○	○			166
C-CES 2000S	φ0.2 ~ φ12	●	●	●	●	○					○			●			○	○			180
C-CES 4000	φ1 ~ φ20	●	●	●	●	○					○			●			○	○			194
C-CES 4000S	φ1 ~ φ12	●	●	●	●	○					○			●			○	○			200

High Efficiency

CZS	φ1 ~ φ20	●	●	●	●	○					○	○		●			○	○			202
CXES	φ1 ~ φ16	●	●	●	●	○					○			●			○	○			216

For Hard Materials

HMS	φ1 ~ φ12			○	●	●	●	●														238
------------	----------	--	--	---	---	---	---	---	--	--	--	--	--	--	--	--	--	--	--	--	--	-----

For Aluminum Milling

CAS	φ0.5 ~ φ12										★			○								192
------------	------------	--	--	--	--	--	--	--	--	--	---	--	--	---	--	--	--	--	--	--	--	-----

For Stainless Steel Milling

CEBUS	φ6 ~ φ12	●	★	○							○			○			○	○				228
--------------	----------	---	---	---	--	--	--	--	--	--	---	--	--	---	--	--	---	---	--	--	--	-----

For Copper Electrode Milling

CRN-ES 2000	φ0.2 ~ φ12										○			★	○							186
CRN-ES 4000	φ3 ~ φ12										○			★	○							232

For Plastic Milling

CPS	φ0.3 ~ φ12										○			●	★							190
------------	------------	--	--	--	--	--	--	--	--	--	---	--	--	---	---	--	--	--	--	--	--	-----

For Graphite Milling

DCES 2000	φ0.2 ~ φ6										○	★	○	○	●						○	188
DCES 4000	φ3 ~ φ10										○	★	○	○	●						○	234
CGE	φ2 ~ φ20										○	★	○	○	○							236

★ Highly Recommended ● Recommended ○ Suggested













Tool Type

Number of Flute	Appearance	Model Number	Coating	Helix Angle	Features
-----------------	------------	--------------	---------	-------------	----------



Long Neck Square

Long Neck Square for Steels



High Precision, for Finishing

2 Flutes		VHLS		30°	V series $\phi 3$ shank x overall length 38 2 flute long neck square for Hard Materials	Negative rake angle 
2 Flutes		HLS 2000		30°	2 flute long neck square for Hard Materials	Negative rake angle 
2 Flutes		C-CER		30°	From Raw Materials and SUS to 55HRC 2 flute long neck square	Positive rake angle 
4 Flutes		HLS 4000		30°	4 flute long neck square for Hard Materials	Negative rake angle 



High Efficiency

4 Flutes		CXS		37° ~ 40°	4 flute highly efficient square with variable pitch and helix design Effective length L/D=3~ about 5 times	
----------	---	------------	---	--------------	---	--

Long Neck Square for Aluminum Milling

3 Flutes		AZS	—	45°	NON-COAT 3 flute long neck square and enables vertical milling	
3 Flutes		DLC-AZS		45°	AZS with DLC coating	

Long Neck Square for Plastic Milling

2 Flutes		CPR	—	30°	NON-COAT 2 flute long neck square	
2 Flutes		CPRL	—	30°	CPR with long shank Long neck & long shank	

Long Neck Square for Graphite Milling









2 Flutes		DCLS		30°	DIA COAT 2 flute long neck square	
----------	--	-------------	--	-----	-----------------------------------	--

Radius

Radius for Steels

2 Flutes		C-CRS		30°	Standard	Neutral rake angle 
----------	---	--------------	---	-----	----------	--

High Efficiency

4 Flutes		CXERS		37° ~ 40°	4 flute highly efficient radius square with variable pitch and helix design From Raw Materials and SUS to 55HRC	Positive rake angle 
5 Flutes		CXRS		42° ~ 45°	5 flute highly efficient radius square with variable pitch and helix design From Raw Materials and SUS to 55HRC	Positive rake angle 
4 Flutes		CNRS		45°	4 flute radius square with variable pitch and high helix For Titanium Alloys and Heat Resistant Alloys milling	Positive rake angle 

For Hard Materials

4-6 Flutes		HMERS		45°	For Hard Materials (~ 65HRC) 4-6 flute radius	Negative rake angle 
------------	---	--------------	---	-----	--	---

Model Number	Size	Carbon Steels	Alloy Steels SUS	Prehardened Steels	Hardened Steels					Cast Iron	Aluminum Alloys	Graphite	Copper	Plastics	Glass Filled Plastics	Titanium Alloys	Heat Resistant Alloys	Cemented Carbide	Hard Brake (Non-Metallic) Materials	Page
					50 HRC	55 HRC	60 HRC	65 HRC	70 HRC											

Long Neck Square

For Steels

High Precision, for Finishing

VHLS	φ0.1 ~ φ2	○	○	●	●	●	○			○			○			○	○			52
HLS 2000	φ0.1 ~ φ6	○	○	●	●	●	○			○			○			○	○			242
C-CER	φ0.1 ~ φ6	●	●	●	●	○				○			●			○	○			256
HLS 4000	φ1 ~ φ6	○	○	●	●	●	○			○			○			○	○			288

High Efficiency

CXS	φ1 ~ φ12	●	●	●	●	○				○			●			○	○			294
------------	----------	---	---	---	---	---	--	--	--	---	--	--	---	--	--	---	---	--	--	-----

For Aluminum Milling

AZS	φ1 ~ φ12									★			○	○						278
DLC-AZS	φ1 ~ φ12									★			○	○						282

For Plastic Milling

CPR	φ0.5 ~ φ6									○			●	★						270
CPRL	φ0.5 ~ φ4									○			●	★						274

For Graphite Milling

DCLS	φ0.4 ~ φ6									○	★		○	○	●					○	266
-------------	-----------	--	--	--	--	--	--	--	--	---	---	--	---	---	---	--	--	--	--	---	-----

Radius

For Steels

C-CRS	φ1 ~ φ12	●	●	●	●	●				○			●			○	○			302
High Efficiency																				
CXERS	φ1 ~ φ12	●	●	●	●	●				○			●			○	○			310
CXRS	φ3 ~ φ12	●	●	●	●	●				○	○		●			○	○			316
CNRS	φ6 ~ φ12	●	●	●	●	●				○	○		●			★	★			306

For Hard Materials

HMERS	φ3 ~ φ12			○	●	●	●	●													320
--------------	----------	--	--	---	---	---	---	---	--	--	--	--	--	--	--	--	--	--	--	--	-----

★ Highly Recommended ● Recommended ○ Suggested













Tool Type

Number of Flute	Appearance	Model Number	Coating	Helix Angle	Features
-----------------	------------	--------------	---------	-------------	----------















Long Neck Radius

Long Neck Radius for Steels

High Precision, for Finishing

2 Flutes		VHLRS		30°	V series $\phi 3$ shank x overall length 38 2 flute long neck radius for Hard Materials	Negative rake angle 
2 Flutes		HLRS 2000/E		30°	2 flute long neck radius for Hard Materials	Negative rake angle 
4 Flutes		HGLRS		30°	For Hard Materials (~ 70HRC) 4 flute long neck radius	Super negative rake angle 
4 Flutes		HLRS 4000		30°	4 flute long neck radius for Hard Materials	Negative rake angle 



High Efficiency

4 Flutes		HRRS		45°	4 flute highly efficient long neck radius with variable pitch and back taper geometry	Negative rake angle 
4 Flutes		HRRS-S		45°	HRRS with short shank	Negative rake angle 
4 Flutes		CRRS		45°	From Raw Materials and SUS to 55HRC 4 flute highly efficient long neck radius with effective length L/D=3 times	Positive rake angle 
5 Flutes		CXLRS		42° ~ 45°	Effective length L/D=3-4 times 5 flute highly efficient long neck radius with variable pitch and helix design	Positive rake angle 
5-6 Flutes		HGRRS		45°	For Hard Materials (~70HRC) 5-6 flute highly efficient long neck radius with effective length L/D=3 times	Super negative rake angle 

High Rigidity

4-6 Flutes		HHRS		30° & 45°	For Hard Materials 4-6 flute long neck radius with effective length L/D=3 times	Positive rake angle 
------------	---	-------------	---	--------------	--	---







CBN Long Neck Radius

1 Flute		CBN-RSF	—	0°	SF series provides excellent surface finish 1 flute long neck radius	
2 Flutes		CBN-LRF 2000	—	0°	High rigidity and long tool life 2 flute long neck radius	
4 Flutes		CBN-LRF 4000	—	0°	High rigidity and long tool life 4 flute long neck radius	

Long Neck Radius for Graphite Milling

4 Flutes		DCLRS		30°	DIA COAT 4 flute long neck radius	
----------	---	--------------	---	-----	-----------------------------------	--

UDC Long Neck Radius for Cemented Carbide and Hard Brittle Materials

1 Flute		UPDLRS	—	0°	1 flute long neck radius with binderless PCD After milling with UDC, improve mirror surface finish by using UPD	
2 Flutes		UDCLRSF		0°	Excellent surface quality 2 flute long neck radius	
2 Flutes		UDCLRS		0°	Lower costs 2 flute long neck radius	
6-10 Flutes		UDCRRS		40°	For roughing 6-10 flute highly efficient long neck radius	

Taper Neck Radius

Taper Neck Radius for Steels

4 Flutes		HTNRS		45°	4 flute taper neck radius for Hard Materials Variable pitch & high helix & back taper geometry	Negative rake angle 
----------	---	--------------	---	-----	---	---

Model Number	Size	Carbon Steels	Alloy Steels SUS	Prehardened Steels	Hardened Steels					Cast Iron	Aluminum Alloys	Graphite	Copper	Plastics	Glass Filled Plastics	Titanium Alloys	Heat Resistant Alloys	Cemented Carbide	Hard Brittle (Non-Metallic) Materials	Page
					50 HRC	55 HRC	60 HRC	65 HRC	70 HRC											

Long Neck Radius

For Steels

High Precision, for Finishing

VHLRS	φ0.2 ~ φ2	○	○	●	●	●	●	○		○			●			○	○			55
HRLRS 2000/E	φ0.2 ~ φ6	○	○	●	●	●	●	○		○			●			○	○			324
HGLRS	φ0.2 ~ φ6			○	●	●	●	★	★											344
HRLRS 4000	φ0.2 ~ φ6	○	○	●	●	●	●	○		○			○			○	○			358

High Efficiency

HRRS	φ2 ~ φ12			●	●	●	●	○		○										382
HRRS-S	φ2 ~ φ12			●	●	●	●	○		○										388
CRRS	φ2 ~ φ12	●	●	●	●					○	○		●			●	●			390
CXLRs	φ3 ~ φ12	●	●	●	●					○	○		●			○	○			400
HGRRS	φ2 ~ φ12			○	●	●	★	●	●											408

High Rigidity

HHRS	φ3 ~ φ12	○	○	●	●	●	○			○			○			○	○			404
-------------	----------	---	---	---	---	---	---	--	--	---	--	--	---	--	--	---	---	--	--	-----

CBN

CBN-RSF	φ0.2 ~ φ2						●	●												132
CBN-LRF 2000	φ0.1 ~ φ3			○	●	●	●	●	●											136
CBN-LRF 4000	φ0.1 ~ φ2			○	●	●	●	●	●											146

For Graphite Milling

DCLRS	φ1 ~ φ6									○	★	○	○	●					○	396
--------------	---------	--	--	--	--	--	--	--	--	---	---	---	---	---	--	--	--	--	---	-----

UDC for Cemented Carbide and Hard Brittle Materials

UPDLRS	φ0.2 ~ φ2																	★	●	108
UDCLRSF	φ0.25 ~ φ2													○				★	●	90
UDCLRS	φ0.3 ~ φ2													○				★	●	98
UDCRRS	φ2 ~ φ6													○				★	●	104

Taper Neck Radius

For Steels

HTNRS	φ1 ~ φ6			●	●	●	●	○		○										412
--------------	---------	--	--	---	---	---	---	---	--	---	--	--	--	--	--	--	--	--	--	-----















★ Highly Recommended ● Recommended ○ Suggested

Tool Type

Number of Flute	Appearance	Model Number	Coating	Helix Angle	Features
-----------------	------------	--------------	---------	-------------	----------

Ball

Ball for Steels

2 Flutes		HGB	HMG COAT	30°	For Hard Materials (~ 70HRC) 2 flute ball	Super negative rake angle 
2 Flutes		HSB	HARD MAX	30°	2 flute ball for Hard Materials The most popular multi-purpose tool	Negative rake angle 
2 Flutes		HSB-S	HARD MAX	30°	HSB with short shank	Negative rake angle 
2 Flutes		CSEB	UT COAT	30°	Standard 2 flute ball Excellent surface quality	Neutral rake angle 
3 Flutes		CFB	UT COAT	30°	From Raw Materials, SUS, Aluminum to 55HRC 3 flute highly efficient ball for excellent surface quality	Positive rake angle 
4 Flutes		HFB	HARD MAX	40°	4 flute ball for Hard Materials High feed and highly efficient milling	Negative rake angle 
4 Flutes		HFB-S	HARD MAX	40°	HFB with short shank	Negative rake angle 



Long Shank Ball

2 Flutes		HBL	HARD MAX	30°	HB with long shank 2 flute long shank ball (straight shank)	Positive rake angle 
----------	---	------------	----------	-----	--	---



Ball for Aluminum Milling

3 Flutes		DLC-CFB	DLC	30°	DLC coating 3 flute ball	
----------	---	----------------	-----	-----	--------------------------	--

Ball for Graphite Milling









2 Flutes		DCB	DIA	35°	DIA COAT 2 flute ball	
2 Flutes		CGB 2000	—	35°	NON-COAT 2 flute ball	
4 Flutes		CGB 4000	—	35°	NON-COAT 4 flute ball	

UDC Ball for Cemented Carbide and Hard Brittle Materials

2 Flutes		UDCBH	UDC	0°	High efficiency 2 flute ball	
2 Flutes		UDCBF	UDC	0°	2 flute ball for excellent surface finish	
2 Flutes		UDCB	UDC	0°	Lower costs 2 flute ball	

Long Neck Ball

Long Neck Ball for Steels

2 Flutes		VHGLB	HMG COAT	30°	V series $\phi 3$ shank x overall length 38 2 flute long neck ball for Hard Materials	Super negative rake angle 
2 Flutes		HGLB	HMG COAT	30°	For Hard Materials (~ 70HRC) 2 flute long neck ball	Super negative rake angle 
2 Flutes		HWLB	HMW COAT	30°	2 flute long neck ball for Hard Materials Using upgraded version of HARDMAX coating	Negative rake angle 
2 Flutes		VHSLB	HARD MAX	30°	V series $\phi 3$ shank x overall length 38 2 flute long neck ball for Hard Materials	Negative rake angle 

Model Number	Size	Carbon Steels	Alloy Steels SUS	Prehardened Steels	Hardened Steels					Cast Iron	Aluminum Alloys	Graphite	Copper	Plastics	Glass Filled Plastics	Titanium Alloys	Heat Resistant Alloys	Cemented Carbide	Hard Brittle (Non-Metallic) Materials	Page
					50 HRC	55 HRC	60 HRC	65 HRC	70 HRC											

Ball

For Steels																					
HGB	R0.05 ~ R3			○	●	●	●	★	★												422
HSB	R0.03 ~ R6	○	○	●	●	●	●	○		○			○			○	○				424
HSB-S	R0.1 ~ R2	○	○	●	●	●	●	○		○			○			○	○				428
CSEB	R0.05 ~ R6	●	●	●	●	●				○	●		●			○	○				432
CFB	R0.3 ~ R6	●	●	●	●	●				○	●		●	○		●	●				442
HFB	R1 ~ R6				●	●	●	●	●												452
HFB-S	R1 ~ R6				●	●	●	●	●												453

Long Shank

HBL	R1.5 ~ R6	○	○	●	●	●	○			○			●			○	○				430
------------	-----------	---	---	---	---	---	---	--	--	---	--	--	---	--	--	---	---	--	--	--	-----

For Aluminum Milling

DLC-CFB	R0.3 ~ R6										★		○	○							448
----------------	-----------	--	--	--	--	--	--	--	--	--	---	--	---	---	--	--	--	--	--	--	-----

For Graphite Milling

DCB	R0.5 ~ R6										○	★	○	○	●					○	438
CGB 2000	R0.2 ~ R6										○	★	○	○	○						440
CGB 4000	R2 ~ R10										○	★	○	○	○						458

UDC for Cemented Carbide and Hard Brittle Materials

UDCBH	R0.3 ~ R1														○				★	●	68
UDCBF	R0.1 ~ R3														○				★	●	70
UDCB	R0.1 ~ R3														○				★	●	72











Long Neck Ball



For Steels																					
VHGLB	R0.05 ~ R1.5			○	●	●	●	★	★												34
HGLB	R0.05 ~ R3			○	●	●	●	★	★												460
HWLB	R0.25 ~ R1	○	○	●	★	★	★	●	●	○			○			○	○				470
VHSLB	R0.05 ~ R1.5	○	○	●	●	●	●	○		○			○			○	○				37



★ Highly Recommended ● Recommended ○ Suggested

Tool Type

Number of Flute	Appearance	Model Number	Coating	Helix Angle	Features
-----------------	------------	--------------	---------	-------------	----------





Long Neck Ball for Steels						
2 Flutes		HSLB	HARD MAX	30°	2 flute long neck ball for Hard Materials The most popular multi-purpose tool	Negative rake angle 
2 Flutes		HSLB-S	HARD MAX	30°	HSLB with short shank	Negative rake angle 
2 Flutes		VCSELB	UT COAT	30°	V series $\phi 3$ shank x overall length 38 Standard 2 flute long neck ball	Neutral rake angle 
2 Flutes		CSELB	UT COAT	30°	Standard 2 flute long neck ball Excellent surface quality	Neutral rake angle 
3 Flutes		CFLB	UT COAT	30°	From Raw Materials, SUS, Aluminum to 55HRC 3 flute long neck ball for excellent surface quality	Positive rake angle 

CBN Long Neck Ball						
2 Flutes		CBN-PLB	—	0°	For super mirror milling (burnishing effect) 2 flute long neck ball	
2 Flutes		CBN-LBSF	—	20°	Excellent surface quality 2 flute long neck ball	
2 Flutes		CBN-LBF	—	0°	High rigidity and long tool life 2 flute long neck ball	



Long Neck Ball for Copper Electrode Milling						
2 Flutes		VDCLB	DLC	30°	V series $\phi 3$ shank x overall length 38 DLC coating 2 flute long neck ball	Positive rake angle 
2 Flutes		DLCLB	DLC	30°	DLC coating 2 flute long neck ball	Positive rake angle 

Long Neck Ball for Plastic Milling						
2 Flutes		CPRB	—	30°	NON-COAT 2 flute long neck ball	

Long Neck Ball for Graphite Milling						
2 Flutes		DCLB	DIA	35°	DIA COAT 2 flute long neck ball	

UDC Long Neck Ball for Cemented Carbide and Hard Brittle Materials						
1 Flute		UPDLB	—	0°	1 flute long neck ball with binderless PCD After milling with UDC, improve mirror surface finish by using UPD	
2 Flutes		UDCLBH	UDC	0°	High efficiency 2 flute long neck ball	
2 Flutes		UDCLBF	UDC	0°	For finishing 2 flute long neck ball	
2 Flutes		UDCLB	UDC	0°	Lower costs 2 flute long neck ball	

Taper Neck Ball

Taper Neck Ball for Steels						
2 Flutes		HTNB	HARD MAX	30°	2 flute taper neck ball	Positive rake angle 
3 Flutes		HFTNB	HARD MAX	40°	For Hard Materials 3 flute taper neck ball	Negative rake angle 

Taper Neck Ball for Graphite Milling						
2 Flutes		DCTNB	DIA	35°	DIA COAT 2 flute taper neck ball	

Model Number	Size	Carbon Steels	Alloy Steels SUS	Prehardened Steels	Hardened Steels					Cast Iron	Aluminum Alloys	Graphite	Copper	Plastics	Glass Filled Plastics	Titanium Alloys	Heat Resistant Alloys	Cemented Carbide	Hard Brittle (Non-Metallic) Materials	Page
					50 HRC	55 HRC	60 HRC	65 HRC	70 HRC											

For Steels																				
HSLB	R0.05 ~ R3	○	○	●	●	●	●	○		○			○			○	○			476
HSLB-S	R0.1 ~ R3	○	○	●	●	●	●	○		○			○			○	○			492
VCSELB	R0.05 ~ R1.5	●	●	●	●	●				○	●		●			○	○			44
CSELB	R0.05 ~ R3	●	●	●	●	●				○	●		●			○	○			496
CFLB	R0.3 ~ R3	●	●	●	●	●				○	●		●	○		●	●			530
CBN																				
CBN-PLB	R0.2 ~ R0.5			○	●	●	●	●	●											120
CBN-LBSF	R0.05 ~ R1			○	●	●	●	●	●											122
CBN-LBF	R0.05 ~ R2			○	●	●	●	●	●											126
For Copper Electrode Milling																				
VDCLB	R0.05 ~ R1										●		★							48
DLCLB	R0.05 ~ R3										●		★							516
For Plastic Milling																				
CPRB	R0.2 ~ R3										○		●	★						526
For Graphite Milling																				
DCLB	R0.2 ~ R3										○	★	○	○	●					512
UDC for Cemented Carbide and Hard Brittle Materials																				
UPDLB	R0.1 ~ R1																	★	●	88
UDCLBH	R0.3 ~ R1																	★	●	76
UDCLBF	R0.1 ~ R3																	★	●	80
UDCLB	R0.1 ~ R3																	★	●	84

Taper Neck Ball

For Steels																				
HTNB	R0.1 ~ R2	○	○	●	●	●	●	●		○			●			○	○			536
HFTNB	R0.5 ~ R2	○	○	●	●	●	●	●		○						○	○			558
For Graphite Milling																				
DCTNB	R0.5 ~ R1										○	★	○	○	●					556





★ Highly Recommended ● Recommended ○ Suggested

Tool Type







Number of Flute	Appearance	Model Number	Coating	Helix Angle	Features
-----------------	------------	--------------	---------	-------------	----------

Taper / Barrel / Chamfering / Drill

Taper

2 Flutes		C-CTE 2000		30°	2 flute taper end mill Half included angle 30°~15°
4 Flutes		C-CTE 4000		30°	4 flute taper end mill Half included angle 30°~7°

Barrel Form



4 Flutes		COVB		—	Oval barrel form Suitable for narrow area with small inclined angle
4 Flutes		CSTB		—	Standard taper barrel form Suitable for highly efficient finishing with larger barrel R
4 Flutes		CWTB		—	Wide taper barrel form Suitable for finishing with wide taper angle

NON-COAT for Chamfering



2 Flutes		SV	—	30°	NON-COAT and half included angle 45° Peripheral spiral shape designed for reducing burrs
----------	---	-----------	---	-----	---

Drill







Over All Length 38.1 x Shank Diameter 3.175 mm
P Series Micro Diameter Drill / Chamfering Cutter and Center Drill

2 Flutes		PMD STD	—	—	NON-COAT micro diameter drill Flute length L/D=10 times	4-facet drill point
2 Flutes		PMD PLT	—	—	NON-COAT micro diameter drill for pilot drilling Flute length L/D=2 times	4-facet drill point
1 Flute		PSM	—	0°	NON-COAT chamfering, counter sink, and center drill Taper angle 45°	—





Flat Drill

2 Flutes		UTDF		30°	Size M4 - M12 for drilling pilot holes before tapping	Point angle 180°
----------	---	-------------	---	-----	---	------------------

Carbide Drill

2 Flutes		UTDSX		30°	Short slot length L/D=5 times Diameter tolerance 0/-0.01	Point angle 130° X thinning
2 Flutes		C-UMD		24°	Medium slot length Diameter tolerance 0/-0.01	Point angle 150°
2 Flutes		UTDLX		30°	Long slot length L/D=15 times Diameter tolerance 0/-0.01	Point angle 130° X thinning

UDC Drill / Thread Mills

2 Flutes		UDCMX		30°	For Cemented Carbide and Hard Brittle Materials Drill
2 Flutes		UDCT		—	For Cemented Carbide and Hard Brittle Materials Thread mill

Model Number	Size	Carbon Steels	Alloy Steels SUS	Prehardened Steels	Hardened Steels					Cast Iron	Aluminum Alloys	Graphite	Copper	Plastics	Glass Filled Plastics	Titanium Alloys	Heat Resistant Alloys	Cemented Carbide	Heat Treat (Non-Metallic) Materials	Page
					50 HRC	55 HRC	60 HRC	65 HRC	70 HRC											

Taper / Barrel / Chamfering / Drill

Taper		Carbon Steels	Alloy Steels SUS	Prehardened Steels	50 HRC	55 HRC	60 HRC	65 HRC	70 HRC	Cast Iron	Aluminum Alloys	Graphite	Copper	Plastics	Glass Filled Plastics	Titanium Alloys	Heat Resistant Alloys	Cemented Carbide	Heat Treat (Non-Metallic) Materials	Page
C-CTE 2000	$\phi 0.2 \sim \phi 2.5$	●	●	●	●	●				○			○							564
C-CTE 4000	$\phi 3 \sim \phi 10$	●	●	●	●	●				○			○							568
Barrel Form		Carbon Steels	Alloy Steels SUS	Prehardened Steels	50 HRC	55 HRC	60 HRC	65 HRC	70 HRC	Cast Iron	Aluminum Alloys	Graphite	Copper	Plastics	Glass Filled Plastics	Titanium Alloys	Heat Resistant Alloys	Cemented Carbide	Heat Treat (Non-Metallic) Materials	Page
COVB	Tip R1 and R2	●	●	●	●	●				○	●		●			○	○			572
CSTB	Tip R1 ~ R3	●	●	●	●	●				○	●		●			○	○			574
CWTB	Tip R1	●	●	●	●	●				○	●		●			○	○			576
NON-COAT for Chamfering		Carbon Steels	Alloy Steels SUS	Prehardened Steels	50 HRC	55 HRC	60 HRC	65 HRC	70 HRC	Cast Iron	Aluminum Alloys	Graphite	Copper	Plastics	Glass Filled Plastics	Titanium Alloys	Heat Resistant Alloys	Cemented Carbide	Heat Treat (Non-Metallic) Materials	Page
SV	$\phi 3 \sim \phi 12$	●	●	●						○	○	○	○	○						578
Drill		Carbon Steels	Alloy Steels SUS	Prehardened Steels	50 HRC	55 HRC	60 HRC	65 HRC	70 HRC	Cast Iron	Aluminum Alloys	Graphite	Copper	Plastics	Glass Filled Plastics	Titanium Alloys	Heat Resistant Alloys	Cemented Carbide	Heat Treat (Non-Metallic) Materials	Page
P Series Over All Length 38.1 x Shank Diameter 3.175 mm Micro Diameter Drill / Chamfering Cutter and Center Drill																				
PMD STD	$\phi 0.02 \sim \phi 0.1$	○	○	●						○	●		●	●						598
PMD PLT	$\phi 0.02 \sim \phi 0.1$	○	○	●						○	●		●	●						599
PSM	$\phi 1$ X half included angle 45°	○	○	●						○	●		●	●						599
Flat Drill		Carbon Steels	Alloy Steels SUS	Prehardened Steels	50 HRC	55 HRC	60 HRC	65 HRC	70 HRC	Cast Iron	Aluminum Alloys	Graphite	Copper	Plastics	Glass Filled Plastics	Titanium Alloys	Heat Resistant Alloys	Cemented Carbide	Heat Treat (Non-Metallic) Materials	Page
UTDF	$\phi 2 \sim \phi 12$	●	●	○						●	●									580
Carbide Drill		Carbon Steels	Alloy Steels SUS	Prehardened Steels	50 HRC	55 HRC	60 HRC	65 HRC	70 HRC	Cast Iron	Aluminum Alloys	Graphite	Copper	Plastics	Glass Filled Plastics	Titanium Alloys	Heat Resistant Alloys	Cemented Carbide	Heat Treat (Non-Metallic) Materials	Page
UTDSX	$\phi 0.3 \sim \phi 2$	●	●	○						○	●		○			○	○			586
C-UMD	$\phi 0.1 \sim \phi 3$	●	●	○						○	●		○			○	○			588
UTDLX	$\phi 0.3 \sim \phi 3$	●	●	○						○	●		○			○	○			594
UDC Drill / Thread Mill		Carbon Steels	Alloy Steels SUS	Prehardened Steels	50 HRC	55 HRC	60 HRC	65 HRC	70 HRC	Cast Iron	Aluminum Alloys	Graphite	Copper	Plastics	Glass Filled Plastics	Titanium Alloys	Heat Resistant Alloys	Cemented Carbide	Heat Treat (Non-Metallic) Materials	Page
UDCMX	$\phi 0.3 \sim \phi 7$			●											●			★	●	110
UDCT	M2 ~ M8			●										○				★	●	114

★ Highly Recommended ● Recommended ○ Suggested













Series

※ For the different types of square, radius and ball for steels, please refer to "Tool Type".

Number of Flute	Appearance	Model Number	Coating	Helix Angle	Features
-----------------	------------	--------------	---------	-------------	----------

V Series / $\phi 3$ Shank x Overall Length 38

V Series Long Neck Ball

2 Flutes		VHGLB		30°	Long neck ball for hard materials Suitable for 60HRC or above such as high-speed steels	Super negative rake angle 
2 Flutes		VHSLB		30°	Long neck ball for hard materials	Negative rake angle 
2 Flutes		VCSELB		30°	Standard shaped long neck ball Prioritizes surface quality	Neutral rake angle 
2 Flutes		VDCLB		30°	DLC coated long neck ball Prevents burrs and chattering with positive rake angle	Positive rake angle 

V Series Long Neck Square



2 Flutes		VHLS		30°	Long neck square for hard materials	Negative rake angle 
----------	---	-------------	---	-----	-------------------------------------	---

V Series Long Neck Radius



2 Flutes		VHLRS		30°	Long neck radius for hard materials	Negative rake angle 
----------	---	--------------	---	-----	-------------------------------------	---

CBN

CBN Long Neck Ball







2 Flutes		CBN-PLB	—	0°	For super mirror milling (burnishing effect) 2 flute long neck ball	
2 Flutes		CBN-LBSF	—	20°	Excellent surface quality 2 flute long neck ball	
2 Flutes		CBN-LBF	—	0°	High rigidity and long tool life 2 flute long neck ball	

CBN Long Neck Radius







1 Flute		CBN-RSF	—	0°	Excellent surface finish 1 flute long neck radius	
2 Flutes		CBN-LRF 2000	—	0°	High rigidity and long tool life 2 flute long neck radius	
4 Flutes		CBN-LRF 4000	—	0°	High rigidity and long tool life 4 flute long neck radius	

UDC for Cemented Carbide and Hard Brittle Materials

UDC Ball

2 Flutes		UDCBH		0°	High efficiency 2 flute ball	
2 Flutes		UDCBF		0°	For finishing 2 flute ball	
2 Flutes		UDCB		0°	Lower costs 2 flute ball	

UDC Long Neck Ball

2 Flutes		UDCLBH		0°	High efficiency 2 flute long neck ball	
2 Flutes		UDCLBF		0°	For finishing 2 flute long neck ball	
2 Flutes		UDCLB		0°	Lower costs 2 flute long neck ball	

Model Number	Size	Carbon Steels	Alloy Steels SUS	Prehardened Steels	Hardened Steels					Cast Iron	Aluminum Alloys	Graphite	Copper	Plastics	Glass Filled Plastics	Titanium Alloys	Heat Resistant Alloys	Cemented Carbide	Hard Brittle (Non-Metallic) Materials	Page
					≤ 50 HRC	≤ 55 HRC	≤ 60 HRC	≤ 65 HRC	≤ 70 HRC											

V Series / φ3 Shank x Overall Length 38

V Series Long Neck Ball

VHGLB	R0.05 ~ R1.5			○	●	●	●	★	★											34
VHSLB	R0.05 ~ R1.5	○	○	●	●	●	●	○		○			○			○	○			37
VCSELB	R0.05 ~ R1.5	●	●	●	●	●				○	●		●			○	○			44
VDCLB	R0.05 ~ R1									●		★								48

V Series Long Neck Square

VHLS	φ0.1 ~ φ2	○	○	●	●	●	○			○			○			○	○			52
-------------	-----------	---	---	---	---	---	---	--	--	---	--	--	---	--	--	---	---	--	--	----

V Series Long Neck Radius

VHLRS	φ0.2 ~ φ2	○	○	●	●	●	●	○		○			●			○	○			55
--------------	-----------	---	---	---	---	---	---	---	--	---	--	--	---	--	--	---	---	--	--	----

CBN

CBN Long Neck Ball

CBN-PLB	R0.2 ~ R0.5			○	●	●	●	●	●											120
CBN-LBSF	R0.05 ~ R1			○	●	●	●	●	●											122
CBN-LBF	R0.05 ~ R2			○	●	●	●	●	●											126

CBN Long Neck Radius

CBN-RSF	φ0.2 ~ φ2						●	●												132
CBN-LRF 2000	φ0.1 ~ φ3			○	●	●	●	●	●											136
CBN-LRF 4000	φ0.1 ~ φ2			○	●	●	●	●	●											146

UDC for Cemented Carbide and Hard Brittle Materials

UDC Ball

UDCBH	R0.3 ~ R1														○			★	●	68
UDCBF	R0.1 ~ R3														○			★	●	70
UDCB	R0.1 ~ R3														○			★	●	72































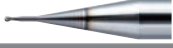



UDC Long Neck Ball

UDCLBH	R0.3 ~ R1														○			★	●	76
UDCLBF	R0.1 ~ R3														○			★	●	80
UDCLB	R0.1 ~ R3														○			★	●	84

★ Highly Recommended ● Recommended ○ Suggested

Series

※ For the different types of square, radius and ball for steels, please refer to "Tool Type".

Number of Flute	Appearance	Model Number	Coating	Helix Angle	Features	
UDC Long Neck Radius						
2 Flutes		UDCLRSF		0°	For finishing 2 flute long neck radius	
2 Flutes		UDCLRS		0°	Lower costs 2 flute long neck radius	
6-10 Flutes		UDCRRS		40°	6-10 flute highly efficient long neck radius for roughing	
UDC Drill						
2 Flutes		UDCMX		30°	Drills for Cemented Carbide and Hard Brittle Materials	
UDC for Threading						
2 Flutes		UDCT		—	Thread mills for Cemented Carbide and Hard Brittle Materials	
PCD for Finishing Cemented Carbide and Hard Brittle Materials						
1 Flute		UPDLRS	—	0°	1 flute long neck radius with binderless PCD After milling with UDC, improve mirror surface finish by using UPD	
1 Flute		UPDLB	—	0°	1 flute long neck ball with binderless PCD After milling with UDC, improve mirror surface finish by using UPD	
For Copper Electrode Milling						
2 Flutes		CRN-ES 2000		20°	CrN COAT 2 flute square	Positive rake angle 
4 Flutes		CRN-ES 4000		25°	CrN COAT 4 flute square	Positive rake angle 
2 Flutes		VDLCLB		30°	V series $\phi 3$ shank x overall length 38 DLC coating 2 flute long neck ball	Positive rake angle 
2 Flutes		DLCLB		30°	DLC coating 2 flute long neck ball	Positive rake angle 
For Stainless Steel Milling						
4 Flutes		CESUS		40° ~ 42°	Special design for SUS milling 4 flute highly efficient square with variable pitch and helix design	
For Aluminum Milling						
2 Flutes		CAS	—	45°	NON-COAT 2 flute square	
3 Flutes		AZS	—	45°	NON-COAT 3 flute highly efficient long neck square that enables vertical milling	
3 Flutes		DLC-AZS		45°	AZS with DLC coating DLC coating 3 flute long neck square	
3 Flutes		DLC-CFB		30°	DLC coating 3 flute ball	
NON-COAT for Plastic Milling						
2 Flutes		CPS	—	30°	NON-COAT 2 flute square	
2 Flutes		CPR	—	30°	NON-COAT 2 flute long neck square	
2 Flutes		CPRL	—	30°	CPR with long shank NON-COAT 2 flute Long neck & long shank	
2 Flutes		CPRB	—	30°	NON-COAT 2 flute long neck ball	

Model Number	Size	Carbon Steels	Alloy Steels SUS	Prehardened Steels	Hardened Steels					Cast Iron	Aluminum Alloys	Graphite	Copper	Plastics	Glass Filled Plastics	Titanium Alloys	Heat Resistant Alloys	Cemented Carbide	Hard Brittle (Non-Metallic) Materials	Page
					50 HRC	55 HRC	60 HRC	65 HRC	70 HRC											

UDC Long Neck Radius																				
UDCLRSF	φ0.25 ~ φ2													○				★	●	90
UDCLRS	φ0.3 ~ φ2													○				★	●	98
UDCRRS	φ2 ~ φ6													○				★	●	104
UDC Drill																				
UDCMX	φ0.3 ~ φ7													●				★	●	110
UDC for Threading																				
UDCT	M2 ~ M8													○				★	●	114
PCD for Finishing Cemented Carbide and Hard Brittle Materials																				
UPDLRS	φ0.2 ~ φ2																	★	●	108
UPDLB	R0.1 ~ R1																	★	●	88
For Copper Electrode Milling																				
CRN-ES 2000	φ0.2 ~ φ12										○		★	○						186
CRN-ES 4000	φ3 ~ φ12										○		★	○						232
VDLCLB	R0.05 ~ R1										●		★							48
DLCLB	R0.05 ~ R3										●		★							516
For Stainless Steel Milling																				
CESUS	φ6 ~ φ12	●	★	○							○		○			○	○			228
For Aluminum Milling																				
CAS	φ0.5 ~ φ12										★		○							192
AZS	φ1 ~ φ12										★		○	○						278
DLC-AZS	φ1 ~ φ12										★		○	○						282
DLC-CFB	R0.3 ~ R6										★		○	○						448
NON-COAT for Plastic Milling																				
CPS	φ0.3 ~ φ12										○		●	★						190
CPR	φ0.5 ~ φ6										○		●	★						270
CPRL	φ0.5 ~ φ4										○		●	★						274
CPRB	R0.2 ~ R3										○		●	★						526















★ Highly Recommended ● Recommended ○ Suggested

Series



※ For the different types of square, radius and ball for steels, please refer to "Tool Type".

Number of Flute	Appearance	Model Number	Coating	Helix Angle	Features
-----------------	------------	--------------	---------	-------------	----------

DIA COAT for Graphite Milling

2 Flutes		DCEs 2000		30°	DIA COAT 2 flute square
4 Flutes		DCEs 4000		30°	DIA COAT 4 flute square
2 Flutes		DCLS		30°	DIA COAT 2 flute long neck square
4 Flutes		DCLRS		30°	DIA COAT 4 flute long neck radius
2 Flutes		DCB		35°	DIA COAT 2 flute ball
2 Flutes		DCLB		35°	DIA COAT 2 flute long neck ball
2 Flutes		DCTNB		35°	DIA COAT 2 flute taper neck ball

NON-COAT for Graphite Milling

4 Flutes		CGE	—	45°	NON-COAT 4 flute square
2 Flutes		CGB 2000	—	35°	NON-COAT 2 flute ball
4 Flutes		CGB 4000	—	35°	NON-COAT 4 flute ball

Barrel Form



4 Flutes		COVB		—	Oval barrel form Suitable for narrow area with small inclined angle
4 Flutes		CSTB		—	Standard taper barrel form Suitable for highly efficient finishing with larger barrel R
4 Flutes		CWTB		—	Wide taper barrel form Suitable for finishing with wide taper angle

NON-COAT for Chamfering

2 Flutes		SV	—	30°	NON-COAT and half included angle 45° Peripheral spiral shape designed for reducing burrs
----------	---	-----------	---	-----	---

Drill







Over All Length 38.1 x Shank Diameter 3.175 mm
P Series Micro Diameter Drill / Chamfering Cutter and Center Drill

2 Flutes		PMD STD	—	—	NON-COAT micro diameter drill Flute length L/D=10 times	4-facet drill point
2 Flutes		PMD PLT	—	—	NON-COAT micro diameter drill for pilot drilling Flute length L/D=2 times	4-facet drill point
1 Flute		PSM	—	0°	NON-COAT for chamfering, counter sink, and center drill Taper angle 90°	—

Flat Drill

2 Flutes		UTDF		30°	Size M4 - M12 for drilling pilot holes before tapping	Point angle 180°
----------	---	-------------	---	-----	---	------------------

Carbide Drill

2 Flutes		UTDSX		30°	Short slot length L/D=5 times Diameter tolerance 0/-0.01	Point angle 130° X thinning
2 Flutes		C-UMD		24°	Medium slot length Diameter tolerance 0/-0.01	Point angle 150°
2 Flutes		UTDLX		30°	Long slot length L/D=15 times Diameter tolerance 0/-0.01	Point angle 130° X thinning

Model Number	Size	Carbon Steels	Alloy Steels SUS	Prehardened Steels	Hardened Steels					Cast Iron	Aluminum Alloys	Graphite	Copper	Plastics	Glass Filled Plastics	Titanium Alloys	Heat Resistant Alloys	Cemented Carbide	Heat Treatable (Non-ferrous) Materials	Page
					50 HRC	55 HRC	60 HRC	65 HRC	70 HRC											

DIA COAT for Graphite Milling

DCES 2000	φ0.2 ~ φ6										○	★	○	○	●				○	188
DCES 4000	φ3 ~ φ10										○	★	○	○	●				○	234
DCLS	φ0.4 ~ φ6										○	★	○	○	●				○	266
DCLRS	φ1 ~ φ6										○	★	○	○	●				○	396
DCB	R0.5 ~ R6										○	★	○	○	●				○	438
DCLB	R0.2 ~ R3										○	★	○	○	●				○	512
DCTNB	R0.5 ~ R1										○	★	○	○	●				○	556

NON-COAT for Graphite Milling

CGE	φ2 ~ φ20										○	★	○	○	○					236
CGB 2000	R0.2 ~ R6										○	★	○	○	○					440
CGB 4000	R2 ~ R10										○	★	○	○	○					458

Barrel Form

COVB	Tip R1 and R2	●	●	●	●	●				○	●		●			○	○			572
CSTB	Tip R1 ~ R3	●	●	●	●	●				○	●		●			○	○			574
CWTB	Tip R1	●	●	●	●	●				○	●		●			○	○			576

NON-COAT for Chamfering

SV	φ3 ~ φ12	●	●	●						○	○	○	○	○						578
-----------	----------	---	---	---	--	--	--	--	--	---	---	---	---	---	--	--	--	--	--	-----

Drill

Over All Length 38.1 x Shank Diameter 3.175 mm
P Series Micro Diameter Drill / Chamfering Cutter and Center Drill

PMD STD	φ0.02 ~ φ0.1	○	○							○	●		●	●						598
PMD PLT	φ0.02 ~ φ0.1	○	○							○	●		●	●						599
PSM	φ1 x half included angle 45°	○	○							○	●		●	●						599

Flat Drill

UTDF	φ2 ~ φ12	●	●	○						●	●									580
-------------	----------	---	---	---	--	--	--	--	--	---	---	--	--	--	--	--	--	--	--	-----

Carbide Drill

UTDSX	φ0.3 ~ φ2	●	●	○						○	●		○			○	○			586
C-UMD	φ0.1 ~ φ3	●	●	○						○	●		○			○	○			588
UTDLX	φ0.3 ~ φ3	●	●	○						○	●		○			○	○			594

★ Highly Recommended ● Recommended ○ Suggested

Value Series
ϕ3mm Shank End Mills



Recommended for improved milling quality and cost reduction!

New $\phi 3$ mm shank

Union Tool's new standard: Value series

$\phi 3$ mm Shank (h4 tolerance) × Overall length 38 mm

Fixed size of $\phi 3$ Shank x Overall Length 38 mm

$\phi 3$ shank is used to save valuable carbide material. h4 tolerance is compatible for both shrink fit and collet holders. More series to follow in the future.

Cost effective

PCB drills mass production technology is applied to end mills.

To attain affordable prices, we applied our existing and proven automatic mass production technology for blank rods, flute grinding, coating and inspection to these new end mills.

High Quality

Small diameter V series are high-precision as a result of using the latest in-house technologies.

We developed new grinding machines specialized for small diameter end mills for high-precision milling that will innovate manufacturing technology for high-precision, high-efficiency milling.

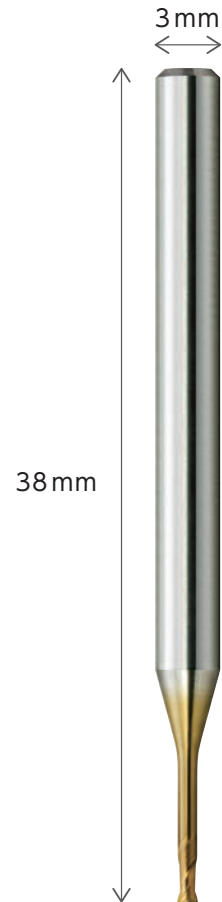

Our in-house developed production facility for PCB tools

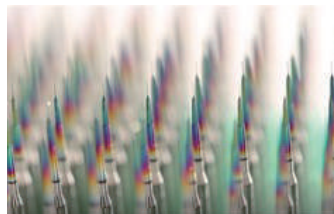

Over 5 million coated PCB tools manufactured every month



Carefully crafted in Mitsuke of Niigata prefecture

PCB: Printed Circuit Board

Find the best coating for your material applications

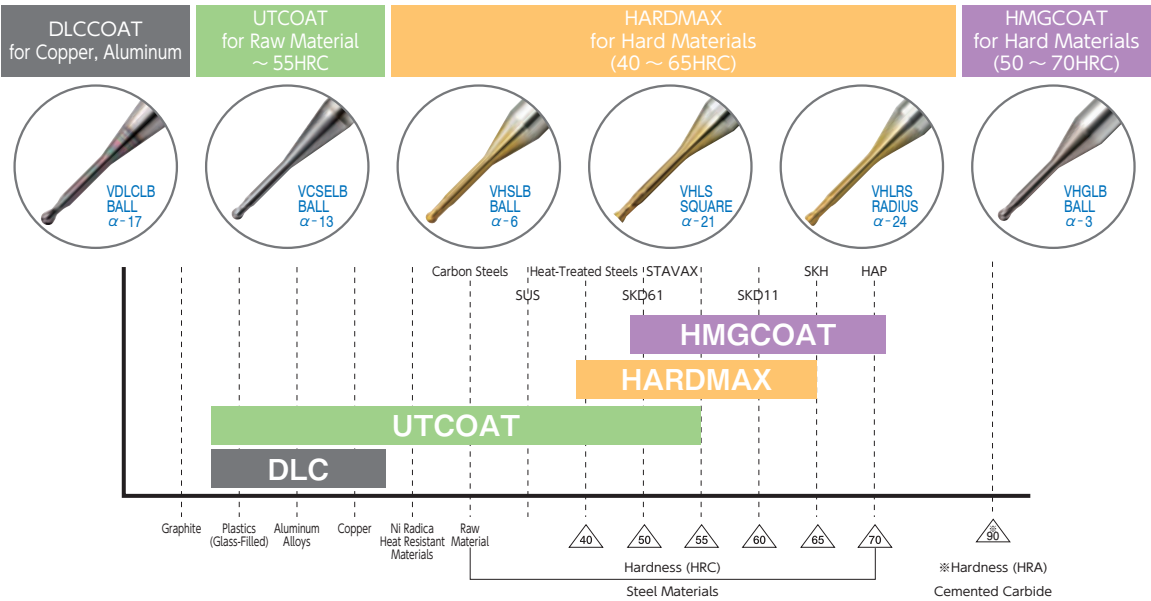

Long Neck Ball End Mills R0.5 x Effective Length 6

Milling examples of shank diameter difference between $\phi 3$ mm & $\phi 4$ mm

Comparison of tool wearing and Dimensional accuracy

<Condition>

Work material : SKD11(60HRC) (DIN : 1.2379, AISI : D2)
 Coolant : Air blow
 Tool holder : Collet holder
 Milling shape : Pocket (□8mm x 8mm x depth 3mm)
 Cycle time : about 35 min.

n : 21,500 min⁻¹
 V_f : 1,250 mm/min
 a_p : 0.03 mm
 a_e : 0.17 mm

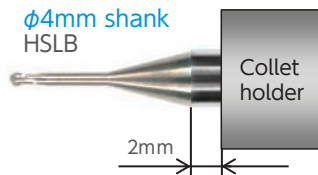
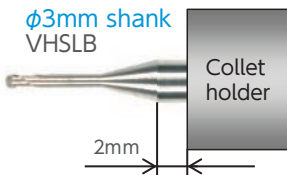

<Tool damage>

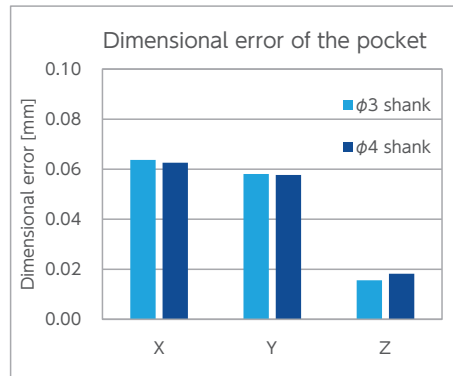
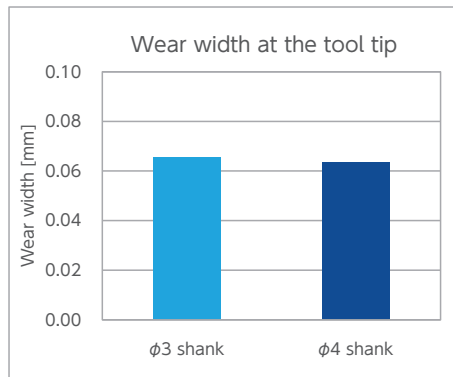
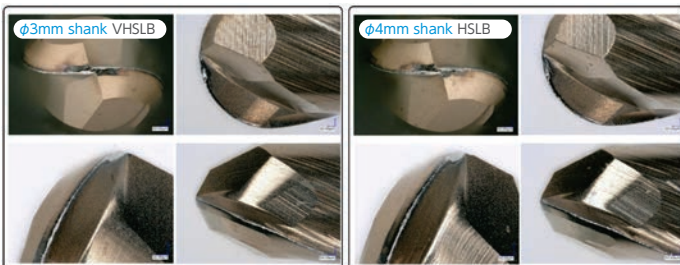

If the overhang is shortened, the performance equivalent to that of a $\phi 4$ mm shank can be obtained.

VHGLB

Value Series HMGCOAT Longneck Ball

HMGCOAT 2 Flutes Short Shank Long Neck Ball End Mills

NEW

Super
MG

HMG
COAT

Shank Dia
0/-0.003



Back Taper
Geometry

Except for R0.05~R0.4

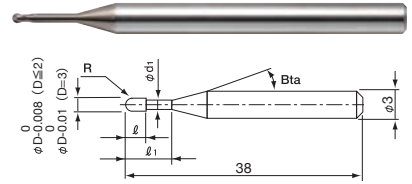

The shank taper angle shown is not an exact value and to avoid contact with the work piece, we recommend the user controls the precise value of this angle. Shank taper angle should not make contact with the work piece.

Radius of Ball Nose	Diameter Tolerance	Ball Radius Accuracy
R0.05 ~ R0.075	0/-0.008	± 0.002
R0.1 ~ R1		± 0.003
R1.5	0/-0.01	

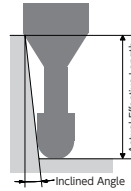

Material Applications (★ Highly Recommended ● Recommended ○ Suggested)

CARBON STEELS S45C S55C	ALLOY STEELS SK / SCM SUS	PREHARDENED STEELS NAK HPM	HARDENED STEELS					CAST IRON	ALUMINUM ALLOYS	GRAPHITE	COPPER	PLASTICS	GLASS FILLED PLASTICS	TITANIUM ALLOYS	HEAT RESISTANT ALLOYS	CEMENTED CARBIDE	HARD BRITTLE (NON-METALLIC) MATERIALS
			~50HRC	~55HRC	~60HRC	~65HRC	~70HRC										
		○	●	●	●	★	★										

Total 31 models

Unit (mm)

Model Number	Radius of Ball Nose R	Effective Length L ₂	Length of Cut L ₃	Neck Diameter φD ₁	Shank Taper Angle Bta	Effective Length by Inclined Angles					Suggested Retail Price ¥
						30°	1°	1° 30'	2°	3°	
VHGLB 2001-003	R0.05	0.3	0.08	0.093	16°	0.34	0.36	0.38	0.40	0.44	6,180
VHGLB 20015-003	R0.075	0.3	0.12	0.14	16°	0.36	0.38	0.40	0.41	0.45	7,200
VHGLB 2002-005	R0.1	0.5	0.16	0.18	16°	0.63	0.66	0.68	0.71	0.76	4,320
VHGLB 2002-010	R0.1	1	0.16	0.18	16°	1.15	1.20	1.24	1.28	1.37	4,320
VHGLB 2003-010	R0.15	1	0.24	0.28	16°	1.15	1.19	1.23	1.27	1.36	4,260
VHGLB 2003-015	R0.15	1.5	0.24	0.28	16°	1.67	1.73	1.78	1.84	1.97	4,560
VHGLB 2004-010	R0.2	1	0.32	0.38	16°	1.15	1.19	1.23	1.27	1.35	2,940
VHGLB 2004-020	R0.2	2	0.32	0.38	16°	2.19	2.25	2.33	2.40	2.57	3,060
VHGLB 2004-030	R0.2	3	0.32	0.38	16°	3.22	3.32	3.43	3.54	3.79	3,360
VHGLB 2005-015	R0.25	1.5	0.4	0.48	16°	1.67	1.72	1.77	1.83	1.95	2,940
VHGLB 2005-020	R0.25	2	0.4	0.48	16°	2.19	2.25	2.32	2.40	2.56	2,940
VHGLB 2005-025	R0.25	2.5	0.4	0.48	16°	2.71	2.79	2.87	2.97	3.18	2,940
VHGLB 2006-010	R0.3	1	0.48	0.58	16°	1.15	1.19	1.22	1.26	1.33	2,520
VHGLB 2006-015	R0.3	1.5	0.48	0.58	16°	1.67	1.72	1.77	1.82	1.94	2,280
VHGLB 2006-020	R0.3	2	0.48	0.58	16°	2.19	2.25	2.32	2.39	2.55	2,280
VHGLB 2006-030	R0.3	3	0.48	0.58	16°	3.22	3.32	3.42	3.53	3.78	2,340
VHGLB 2006-040	R0.3	4	0.48	0.58	16°	4.25	4.38	4.52	4.67	5.00	2,400
VHGLB 2008-020	R0.4	2	0.64	0.78	16°	2.18	2.25	2.31	2.38	2.53	2,280
VHGLB 2008-040	R0.4	4	0.64	0.78	16°	4.25	4.37	4.51	4.66	4.98	2,400
VHGLB 2010-020	R0.5	2	0.8	0.97	16°	2.20	2.26	2.32	2.38	2.53	2,000
VHGLB 2010-025	R0.5	2.5	0.8	0.97	16°	2.72	2.79	2.87	2.95	3.14	2,000
VHGLB 2010-030	R0.5	3	0.8	0.97	16°	3.23	3.32	3.42	3.52	3.75	2,000
VHGLB 2010-040	R0.5	4	0.8	0.97	16°	4.26	4.39	4.52	4.66	4.98	2,160
VHGLB 2010-060	R0.5	6	0.8	0.97	16°	6.33	6.52	6.72	6.94	7.43	2,340
VHGLB 2015-030	R0.75	3	1.2	1.46	16°	3.11	3.19	3.28	3.37	3.57	2,220
VHGLB 2015-040	R0.75	4	1.2	1.46	16°	4.15	4.26	4.38	4.51	4.79	2,220
VHGLB 2015-060	R0.75	6	1.2	1.46	16°	6.21	6.39	6.58	6.78	7.24	2,220
VHGLB 2020-030	R1	3	1.6	1.96	16°	3.11	3.18	3.25	3.33	3.52	2,000
VHGLB 2020-040	R1	4	1.6	1.96	16°	4.14	4.24	4.35	4.47	4.74	2,000
VHGLB 2020-060	R1	6	1.6	1.96	16°	6.20	6.37	6.55	6.75	7.19	2,160
VHGLB 2030-060	R1.5	6	2.4	2.93	-	No Interference	No Interference	No Interference	No Interference	No Interference	2,340

VHGLB Milling Conditions

WORK MATERIAL			PREHARDENED STEELS / HARDENED STEELS NAK / STAVAX (~55HRC)				HARDENED STEELS SKD11 (55~62HRC)				HARDENED STEELS HAP10 (62~66HRC)			
Model Number	Radius of Ball Nose (mm)	Effective Length (mm)	Spindle Speed (min ⁻¹)	Feed Rate (mm/min)	a _p Axial Depth (mm)	a _e Radial Depth (mm)	Spindle Speed (min ⁻¹)	Feed Rate (mm/min)	a _p Axial Depth (mm)	a _e Radial Depth (mm)	Spindle Speed (min ⁻¹)	Feed Rate (mm/min)	a _p Axial Depth (mm)	a _e Radial Depth (mm)
2001-003	R0.05	0.3	48,000	200	0.005	0.01	48,000	200	0.005	0.01	48,000	150	0.003	0.006
20015-003	R0.075	0.3	48,000	230	0.007	0.014	48,000	230	0.007	0.014	48,000	170	0.005	0.01
2002-005	R0.1	0.5	44,000	250	0.01	0.03	42,000	250	0.01	0.03	40,000	200	0.008	0.024
2002-010	R0.1	1	44,000	250	0.01	0.03	42,000	250	0.01	0.03	40,000	200	0.008	0.024
2003-010	R0.15	1	44,000	400	0.01	0.03	42,000	350	0.01	0.03	40,000	300	0.01	0.03
2003-015	R0.15	1.5	44,000	400	0.01	0.03	42,000	350	0.01	0.03	40,000	300	0.01	0.03
2004-010	R0.2	1	44,000	600	0.015	0.045	42,000	550	0.015	0.045	40,000	500	0.013	0.036
2004-020	R0.2	2	44,000	600	0.015	0.045	42,000	550	0.015	0.045	40,000	500	0.013	0.036
2004-030	R0.2	3	35,200	330	0.008	0.024	33,600	310	0.008	0.024	32,000	280	0.008	0.022
2005-015	R0.25	1.5	44,000	900	0.02	0.065	40,000	800	0.015	0.05	36,000	600	0.015	0.05
2005-020	R0.25	2	44,000	900	0.02	0.065	40,000	800	0.015	0.05	36,000	600	0.015	0.05
2005-025	R0.25	2.5	44,000	900	0.02	0.065	40,000	800	0.015	0.05	36,000	600	0.015	0.05
2006-010	R0.3	1	40,000	1,400	0.045	0.15	36,000	1,500	0.03	0.13	32,000	1,000	0.02	0.1
2006-015	R0.3	1.5	40,000	1,400	0.03	0.13	36,000	1,300	0.03	0.13	32,000	1,000	0.02	0.1
2006-020	R0.3	2	40,000	1,400	0.03	0.13	36,000	1,300	0.03	0.13	32,000	1,000	0.02	0.1
2006-030	R0.3	3	40,000	1,200	0.025	0.1	36,000	1,100	0.025	0.1	32,000	900	0.02	0.1
2006-040	R0.3	4	40,000	1,000	0.02	0.08	32,000	800	0.02	0.08	32,000	700	0.015	0.07
2008-020	R0.4	2	35,000	1,600	0.06	0.21	30,000	1,600	0.04	0.17	26,000	1,350	0.04	0.15
2008-040	R0.4	4	35,000	1,600	0.06	0.21	30,000	1,600	0.04	0.17	26,000	1,350	0.04	0.15
2010-020	R0.5	2	30,000	1,750	0.2	0.4	24,000	2,000	0.1	0.3	21,000	1,750	0.05	0.2
2010-025	R0.5	2.5	30,000	1,750	0.2	0.4	24,000	2,000	0.1	0.3	21,000	1,750	0.05	0.2
2010-030	R0.5	3	30,000	1,750	0.1	0.3	24,000	2,000	0.1	0.2	21,000	1,750	0.03	0.17
2010-040	R0.5	4	30,000	1,750	0.1	0.3	24,000	2,000	0.1	0.2	21,000	1,750	0.03	0.17
2010-060	R0.5	6	30,000	1,150	0.06	0.23	21,500	1,250	0.03	0.17	19,700	1,050	0.025	0.15
2015-030	R0.75	3	30,000	2,450	0.25	0.55	17,000	2,000	0.12	0.4	15,000	1,750	0.06	0.29
2015-040	R0.75	4	30,000	2,450	0.25	0.55	17,000	2,000	0.12	0.4	15,000	1,750	0.06	0.29
2015-060	R0.75	6	30,000	2,450	0.15	0.45	17,000	2,000	0.07	0.31	15,000	1,750	0.04	0.24
2020-030	R1	3	28,000	2,900	0.3	0.7	14,000	2,100	0.15	0.5	14,700	2,100	0.15	0.35
2020-040	R1	4	28,000	2,900	0.3	0.7	14,000	2,100	0.15	0.5	14,700	2,100	0.15	0.35
2020-060	R1	6	28,000	2,900	0.2	0.6	14,000	2,100	0.1	0.4	14,700	2,100	0.15	0.3
2030-060	R1.5	6	21,000	3,000	0.4	1	13,250	2,500	0.24	0.55	11,040	2,280	0.24	0.55

2 Flutes

Ø3mm Shank
V Series

UDC-PCD
Series

CBN
Series

Square
Square
Long Neck
Square

Radius
Radius
Long Neck
Radius

Taper Neck
Radius

Ball / Long
Shank Ball
Long Neck
Ball

Taper Neck
Ball

Taper
Taper

Barrel

Spiral
V Cutter

Drill

Technical Data

VHGLB Milling Conditions

WORK MATERIAL			HARDENED STEELS HAP72 (66~70HRC)			
Model Number	Radius of Ball Nose (mm)	Effective Length (mm)	Spindle Speed (min-1)	Feed Rate (mm/min)	a_p Axial Depth (mm)	a_e Radial Depth (mm)
2001-003	R0.05	0.3	40,000	120	0.002	0.004
20015-003	R0.075	0.3	40,000	135	0.003	0.006
2002-005	R0.1	0.5	36,000	150	0.006	0.018
2002-010	R0.1	1	36,000	150	0.006	0.018
2003-010	R0.15	1	36,000	250	0.008	0.024
2003-015	R0.15	1.5	36,000	250	0.008	0.024
2004-010	R0.2	1	36,000	350	0.01	0.027
2004-020	R0.2	2	36,000	350	0.01	0.027
2004-030	R0.2	3	28,000	200	0.006	0.016
2005-015	R0.25	1.5	30,000	400	0.015	0.03
2005-020	R0.25	2	30,000	400	0.015	0.03
2005-025	R0.25	2.5	30,000	400	0.015	0.03
2006-010	R0.3	1	25,000	600	0.02	0.1
2006-015	R0.3	1.5	25,000	600	0.02	0.1
2006-020	R0.3	2	25,000	600	0.02	0.1
2006-030	R0.3	3	25,000	500	0.02	0.1
2006-040	R0.3	4	25,000	400	0.01	0.075
2008-020	R0.4	2	20,000	700	0.02	0.12
2008-040	R0.4	4	20,000	700	0.02	0.12
2010-020	R0.5	2	16,000	875	0.05	0.2
2010-025	R0.5	2.5	16,000	875	0.05	0.2
2010-030	R0.5	3	16,000	875	0.03	0.17
2010-040	R0.5	4	16,000	875	0.03	0.17
2010-060	R0.5	6	14,500	525	0.025	0.15
2015-030	R0.75	3	11,250	875	0.06	0.29
2015-040	R0.75	4	11,250	875	0.06	0.29
2015-060	R0.75	6	11,250	875	0.04	0.24
2020-030	R1	3	12,250	1,800	0.08	0.35
2020-040	R1	4	12,250	1,800	0.08	0.35
2020-060	R1	6	12,250	1,800	0.06	0.3
2030-060	R1.5	6	9,200	1,900	0.12	0.55

- Ø3mm Shank V Series
- UDC-PCD Series
- CBN Series
- Square
- Long Neck Square
- Radius
- Long Neck Radius
- Taper Neck Radius
- Ball / Long Shank Ball
- Long Neck Ball
- Taper Neck Ball
- Taper
- Barrel
- Spiral V Cutter
- Drill
- Technical Data

Note:

- Decrease the feed rate more than 50% from the milling parameters when slot milling.
- Decrease both spindle speed and feed rate proportionally when the milling parameters exceed the machine's maximum spindle speed, or when the tool is chattering and heats up to a red color.
- Every coolant offers stable milling.

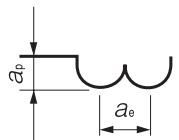

VHSLB

Value Series HARDMAX Longneck Ball

HARDMAX 2 Flutes Short Shank Long Neck Ball End Mills

2 Flutes

NEW

Super
MG

HARD
MAX

Shank Dia
0/-0.003



R0.05



R0.1~R1.5

Back Taper
Geometry

Except for R0.05~R0.4

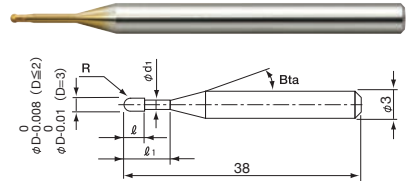

The shank taper angle shown is not an exact value and to avoid contact with the work piece, we recommend the user controls the precise value of this angle. Shank taper angle should not make contact with the work piece.

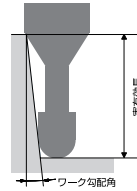

Radius of Ball Nose	Diameter Tolerance	Ball Radius Accuracy	Helix Angle
R0.05	0/-0.008	± 0.002	0°
R0.1 ~ R0.75		± 0.003	30°
R1		± 0.004	
R1.5	0/-0.01	± 0.005	

Material Applications (★ Highly Recommended ● Recommended ○ Suggested)

CARBON STEELS S45C S55C	ALLOY STEELS SK / SCM SUS	PREHARDENED STEELS NAK HPM	HARDENED STEELS					CAST IRON	ALUMINUM ALLOYS	GRAPHITE	COPPER	PLASTICS	GLASS FILLED PLASTICS	TITANIUM ALLOYS	HEAT RESISTANT ALLOYS	CEMENTED CARBIDE	HARD BRITTLE (NON-METALLIC) MATERIALS
			~50HRC	~55HRC	~60HRC	~65HRC	~70HRC										
○	○	●	●	●	○		○			○				○	○		

Total 53 models

Unit (mm)

Model Number	Radius of Ball Nose R	Effective Length ℓ_1	Length of Cut ℓ	Neck Diameter ϕd_1	Shank Taper Angle Bta	Effective Length by Inclined Angles					Suggested Retail Price ¥
						30°	1°	1° 30'	2°	3°	
VHSLB 2001-003	R0.05	0.3	0.08	0.093	11°	0.34	0.37	0.39	0.41	0.46	5,820
VHSLB 2002-003	R0.1	0.3	0.16	0.18	16°	0.43	0.45	0.46	0.48	0.52	4,050
VHSLB 2002-005	R0.1	0.5	0.16	0.18	16°	0.64	0.66	0.69	0.71	0.76	4,050
VHSLB 2002-0075	R0.1	0.75	0.16	0.18	16°	0.90	0.93	0.97	1.00	1.07	4,050
VHSLB 2002-010	R0.1	1	0.16	0.18	16°	1.16	1.20	1.24	1.28	1.38	4,050
VHSLB 2003-005	R0.15	0.5	0.24	0.28	16°	0.63	0.66	0.68	0.71	0.75	3,990
VHSLB 2003-0075	R0.15	0.75	0.24	0.28	16°	0.90	0.93	0.96	0.99	1.06	3,990
VHSLB 2003-010	R0.15	1	0.24	0.28	16°	1.16	1.20	1.24	1.28	1.37	3,990
VHSLB 2003-015	R0.15	1.5	0.24	0.28	16°	1.67	1.73	1.78	1.84	1.97	4,280
VHSLB 2003-020	R0.15	2	0.24	0.28	16°	2.19	2.26	2.33	2.41	2.59	4,280
VHSLB 2003-030	R0.15	3	0.24	0.28	16°	3.22	3.33	3.43	3.55	3.81	4,390
VHSLB 2004-005	R0.2	0.5	0.32	0.38	16°	0.63	0.65	0.68	0.70	0.74	2,740
VHSLB 2004-010	R0.2	1	0.32	0.38	16°	1.15	1.19	1.23	1.27	1.35	2,740
VHSLB 2004-015	R0.2	1.5	0.32	0.38	16°	1.67	1.73	1.78	1.84	1.96	2,800
VHSLB 2004-020	R0.2	2	0.32	0.38	16°	2.19	2.26	2.33	2.41	2.57	2,850
VHSLB 2004-030	R0.2	3	0.32	0.38	16°	3.22	3.32	3.43	3.54	3.80	3,140
VHSLB 2004-040	R0.2	4	0.32	0.38	16°	4.25	4.39	4.53	4.68	5.02	3,420
VHSLB 2005-010	R0.25	1	0.4	0.48	16°	1.15	1.19	1.23	1.26	1.34	2,740
VHSLB 2005-015	R0.25	1.5	0.4	0.48	16°	1.67	1.72	1.77	1.83	1.95	2,740
VHSLB 2005-020	R0.25	2	0.4	0.48	16°	2.19	2.25	2.32	2.40	2.56	2,740
VHSLB 2005-025	R0.25	2.5	0.4	0.48	16°	2.71	2.79	2.87	2.97	3.18	2,740
VHSLB 2005-030	R0.25	3	0.4	0.48	16°	3.22	3.32	3.42	3.54	3.79	2,740
VHSLB 2005-040	R0.25	4	0.4	0.48	16°	4.25	4.38	4.53	4.68	5.01	2,740

3mm Shank V Series

UDC-PCD Series

CBN Series

Square

Long Neck Square

Radius

Long Neck Radius

Taper Neck Radius

Ball / Long Shank Ball

Long Neck Ball

Taper Neck Ball

Taper

Barrel

Spiral V Cutter

Drill

Technical Data

HARDMAX 2 Flutes Short Shank Long Neck Ball End Mills

Model Number	Radius of Ball Nose R	Effective Length ℓ_e	Length of Cut ℓ_c	Neck Diameter ϕd_1	Shank Taper Angle Bta	Effective Length by Inclined Angles					Suggested Retail Price Ψ
						30°	1°	1° 30'	2°	3°	
VHSLB 2006-010	R0.3	1	0.48	0.58	16°	1.15	1.19	1.22	1.26	1.33	2,340
VHSLB 2006-015	R0.3	1.5	0.48	0.58	16°	1.67	1.72	1.77	1.82	1.94	2,110
VHSLB 2006-020	R0.3	2	0.48	0.58	16°	2.19	2.25	2.32	2.39	2.55	2,110
VHSLB 2006-025	R0.3	2.5	0.48	0.58	16°	2.70	2.78	2.87	2.96	3.16	2,170
VHSLB 2006-030	R0.3	3	0.48	0.58	16°	3.22	3.32	3.42	3.53	3.78	2,170
VHSLB 2006-040	R0.3	4	0.48	0.58	16°	4.25	4.38	4.52	4.67	5.00	2,230
VHSLB 2006-050	R0.3	5	0.48	0.58	16°	5.28	5.45	5.62	5.81	6.22	2,230
VHSLB 2006-060	R0.3	6	0.48	0.58	16°	6.31	6.51	6.72	6.95	7.45	2,230
VHSLB 2008-020	R0.4	2	0.64	0.78	16°	2.18	2.25	2.31	2.38	2.53	2,110
VHSLB 2008-030	R0.4	3	0.64	0.78	16°	3.22	3.31	3.41	3.52	3.75	2,230
VHSLB 2008-040	R0.4	4	0.64	0.78	16°	4.25	4.37	4.51	4.66	4.98	2,230
VHSLB 2008-050	R0.4	5	0.64	0.78	16°	5.28	5.44	5.61	5.79	6.20	2,230
VHSLB 2008-060	R0.4	6	0.64	0.78	16°	6.31	6.50	6.71	6.93	7.43	2,230
VHSLB 2010-020	R0.5	2	0.8	0.97	16°	2.20	2.26	2.32	2.39	2.54	2,000
VHSLB 2010-025	R0.5	2.5	0.8	0.97	16°	2.72	2.79	2.87	2.96	3.15	2,000
VHSLB 2010-030	R0.5	3	0.8	0.97	16°	3.24	3.33	3.42	3.53	3.76	2,000
VHSLB 2010-040	R0.5	4	0.8	0.97	16°	4.27	4.39	4.52	4.67	4.98	2,000
VHSLB 2010-050	R0.5	5	0.8	0.97	16°	5.30	5.46	5.62	5.80	6.21	2,000
VHSLB 2010-060	R0.5	6	0.8	0.97	16°	6.33	6.52	6.72	6.94	7.43	2,170
VHSLB 2010-080	R0.5	8	0.8	0.97	16°	8.39	8.65	8.93	9.22	9.88	2,170
VHSLB 2015-030	R0.75	3	1.2	1.46	16°	3.12	3.20	3.28	3.37	3.58	2,050
VHSLB 2015-040	R0.75	4	1.2	1.46	16°	4.15	4.26	4.38	4.51	4.80	2,050
VHSLB 2015-060	R0.75	6	1.2	1.46	16°	6.21	6.39	6.58	6.79	7.25	2,050
VHSLB 2015-080	R0.75	8	1.2	1.46	16°	8.28	8.52	8.78	9.07	9.69	2,170
VHSLB 2020-030	R1	3	1.6	1.96	16°	3.11	3.18	3.26	3.34	3.52	2,000
VHSLB 2020-040	R1	4	1.6	1.96	16°	4.14	4.24	4.36	4.48	4.74	2,000
VHSLB 2020-060	R1	6	1.6	1.96	16°	6.20	6.37	6.56	6.75	7.19	2,000
VHSLB 2020-080	R1	8	1.6	1.96	16°	8.27	8.50	8.76	9.03	9.64	2,170
VHSLB 2030-060	R1.5	6	2.4	2.93	—	No Interference	No Interference	No Interference	No Interference	No Interference	2,170
VHSLB 2030-080	R1.5	8	2.4	2.93	—	No Interference	No Interference	No Interference	No Interference	No Interference	2,170

Ø3mm Shank V Series

UDC-PCD Series

CBN Series

Square
Long Neck Square

Radius

Long Neck Radius
Taper Neck Radius

Ball / Long Shank Ball

Long Neck Ball
Taper Neck Ball

Taper

Barrel

Spiral V Cutter

Drill

Technical Data

VHSLB Milling Conditions

2 Flutes

WORK MATERIAL			COPPER OFC / TPC				CARBON STEELS S45C / S50C (~225HB)				ALLOY STEELS SK / SCM / SUS (225~325HB)			
Model Number	Radius of Ball Nose (mm)	Effective Length (mm)	Spindle Speed (min ⁻¹)	Feed Rate (mm/min)	a _p Axial Depth (mm)	a _e Radial Depth (mm)	Spindle Speed (min ⁻¹)	Feed Rate (mm/min)	a _p Axial Depth (mm)	a _e Radial Depth (mm)	Spindle Speed (min ⁻¹)	Feed Rate (mm/min)	a _p Axial Depth (mm)	a _e Radial Depth (mm)
2001-003	R0.05	0.3	54,000	85	0.004	0.004	54,000	85	0.004	0.004	54,000	85	0.004	0.004
2002-003	R0.1	0.3	54,000	430	0.01	0.01	60,000	350	0.008	0.016	60,000	350	0.008	0.016
2002-005	R0.1	0.5	54,000	430	0.01	0.01	60,000	350	0.008	0.016	60,000	350	0.008	0.016
2002-0075	R0.1	0.75	54,000	380	0.008	0.008	60,000	320	0.007	0.015	60,000	320	0.007	0.015
2002-010	R0.1	1	54,000	380	0.008	0.008	60,000	250	0.005	0.015	60,000	250	0.005	0.015
2003-005	R0.15	0.5	54,000	720	0.015	0.015	43,000	500	0.012	0.024	43,000	500	0.012	0.024
2003-0075	R0.15	0.75	54,000	720	0.015	0.015	43,000	500	0.012	0.024	43,000	500	0.012	0.024
2003-010	R0.15	1	54,000	640	0.014	0.015	43,000	450	0.008	0.024	43,000	450	0.008	0.024
2003-015	R0.15	1.5	54,000	640	0.014	0.015	43,000	400	0.007	0.021	43,000	400	0.007	0.021
2003-020	R0.15	2	49,000	530	0.011	0.011	40,000	300	0.006	0.018	40,000	300	0.006	0.018
2003-030	R0.15	3	43,000	460	0.009	0.01	38,000	200	0.004	0.012	38,000	200	0.004	0.012
2004-005	R0.2	0.5	54,000	870	0.023	0.036	35,000	1,200	0.02	0.04	35,000	1,200	0.02	0.04
2004-010	R0.2	1	54,000	870	0.023	0.036	35,000	1,200	0.02	0.04	35,000	1,200	0.02	0.04
2004-015	R0.2	1.5	54,000	790	0.022	0.036	35,000	900	0.016	0.033	35,000	900	0.016	0.033
2004-020	R0.2	2	54,000	790	0.022	0.036	35,000	600	0.011	0.033	35,000	600	0.011	0.033
2004-030	R0.2	3	50,000	660	0.017	0.018	35,000	400	0.008	0.024	35,000	400	0.008	0.024
2004-040	R0.2	4	50,000	640	0.012	0.018	35,000	300	0.005	0.015	35,000	300	0.005	0.015
2005-010	R0.25	1	57,000	1,380	0.029	0.054	34,000	1,300	0.03	0.06	34,000	1,300	0.03	0.06
2005-015	R0.25	1.5	57,000	1,380	0.029	0.054	34,000	1,000	0.025	0.05	34,000	1,000	0.025	0.05
2005-020	R0.25	2	57,000	1,250	0.028	0.054	34,000	800	0.023	0.046	34,000	800	0.023	0.046
2005-025	R0.25	2.5	57,000	1,250	0.028	0.054	34,000	700	0.015	0.045	34,000	700	0.015	0.045
2005-030	R0.25	3	55,000	1,010	0.021	0.036	32,000	550	0.012	0.036	32,000	550	0.012	0.036
2005-040	R0.25	4	55,000	1,010	0.021	0.036	31,000	450	0.01	0.03	31,000	450	0.01	0.03
2006-010	R0.3	1	57,000	1,670	0.035	0.144	33,000	1,500	0.04	0.08	33,000	1,500	0.04	0.08
2006-015	R0.3	1.5	57,000	1,670	0.035	0.144	33,000	1,500	0.04	0.08	33,000	1,500	0.04	0.08
2006-020	R0.3	2	57,000	1,540	0.034	0.144	33,000	1,400	0.036	0.072	33,000	1,400	0.036	0.072
2006-025	R0.3	2.5	57,000	1,540	0.034	0.144	33,000	1,200	0.033	0.066	33,000	1,200	0.033	0.066
2006-030	R0.3	3	57,000	1,540	0.034	0.144	33,000	900	0.025	0.066	33,000	900	0.025	0.066
2006-040	R0.3	4	54,000	1,130	0.026	0.108	31,000	700	0.02	0.06	31,000	700	0.02	0.06
2006-050	R0.3	5	46,000	960	0.019	0.072	29,000	440	0.015	0.045	29,000	440	0.015	0.045
2006-060	R0.3	6	46,000	960	0.019	0.072	24,000	380	0.012	0.036	24,000	380	0.012	0.036
2008-020	R0.4	2	55,000	2,060	0.063	0.18	30,000	1,800	0.06	0.12	30,000	1,800	0.06	0.12
2008-030	R0.4	3	55,000	1,860	0.063	0.18	30,000	1,600	0.05	0.1	30,000	1,600	0.05	0.1
2008-040	R0.4	4	55,000	1,860	0.063	0.18	30,000	1,300	0.04	0.1	30,000	1,300	0.04	0.1
2008-050	R0.4	5	47,000	1,410	0.038	0.108	30,000	1,100	0.035	0.1	30,000	1,100	0.035	0.1
2008-060	R0.4	6	47,000	1,410	0.038	0.108	27,000	900	0.025	0.075	27,000	900	0.025	0.075
2010-020	R0.5	2	46,000	2,000	0.072	0.36	30,000	1,600	0.08	0.16	30,000	1,600	0.08	0.16
2010-025	R0.5	2.5	46,000	2,000	0.072	0.36	30,000	1,600	0.08	0.16	30,000	1,600	0.08	0.16
2010-030	R0.5	3	46,000	2,000	0.072	0.36	24,000	1,600	0.07	0.14	24,000	1,600	0.07	0.14
2010-040	R0.5	4	46,000	2,000	0.071	0.36	24,000	1,500	0.065	0.13	24,000	1,500	0.065	0.13
2010-050	R0.5	5	46,000	2,000	0.071	0.36	24,000	1,400	0.06	0.12	24,000	1,400	0.06	0.12
2010-060	R0.5	6	39,000	1,500	0.071	0.18	18,000	1,200	0.04	0.12	18,000	1,200	0.04	0.12
2010-080	R0.5	8	39,000	1,500	0.043	0.18	16,500	900	0.027	0.081	16,500	900	0.027	0.081
2015-030	R0.75	3	30,000	2,200	0.171	0.324	30,000	1,600	0.12	0.24	30,000	1,600	0.12	0.24
2015-040	R0.75	4	30,000	2,200	0.171	0.324	30,000	1,500	0.11	0.22	30,000	1,500	0.11	0.22
2015-060	R0.75	6	30,000	1,980	0.147	0.324	23,000	1,300	0.1	0.2	23,000	1,300	0.1	0.2
2015-080	R0.75	8	26,000	1,500	0.106	0.27	18,000	1,100	0.08	0.16	18,000	1,100	0.08	0.16

- Ø3mm Shank V Series
- UDC-PCD Series
- CBN Series
- Square
- Long Neck Square
- Radius
- Long Neck Radius
- Taper Neck Radius
- Ball
- Ball / Long Shank Ball
- Long Neck Ball
- Taper Neck Ball
- Taper
- Barrel
- Spiral V Cutter
- Drill
- Technical Data

VHSLB Milling Conditions

WORK MATERIAL			PREHARDENED STEELS / HARDENED STEELS NAK / STAVAX (~55HRC)				HARDENED STEELS SKD11 (55~62HRC)				HARDENED STEELS HAP10 (62~66HRC)			
Model Number	Radius of Ball Nose (mm)	Effective Length (mm)	Spindle Speed (min-1)	Feed Rate (mm/min)	a _p Axial Depth (mm)	a _e Radial Depth (mm)	Spindle Speed (min-1)	Feed Rate (mm/min)	a _p Axial Depth (mm)	a _e Radial Depth (mm)	Spindle Speed (min-1)	Feed Rate (mm/min)	a _p Axial Depth (mm)	a _e Radial Depth (mm)
2001-003	R0.05	0.3	48,000	55	0.002	0.002	48,000	45	0.002	0.002	48,000	45	0.002	0.002
2002-003	R0.1	0.3	60,000	200	0.003	0.005	60,000	200	0.002	0.003	60,000	130	0.002	0.003
2002-005	R0.1	0.5	60,000	200	0.003	0.005	60,000	200	0.002	0.003	60,000	130	0.002	0.003
2002-0075	R0.1	0.75	60,000	200	0.003	0.005	60,000	200	0.002	0.003	60,000	130	0.002	0.003
2002-010	R0.1	1	60,000	200	0.003	0.005	60,000	200	0.002	0.003	60,000	130	0.002	0.003
2003-005	R0.15	0.5	60,000	350	0.006	0.008	45,000	310	0.004	0.007	43,500	180	0.003	0.005
2003-0075	R0.15	0.75	60,000	350	0.006	0.008	45,000	310	0.004	0.007	43,500	180	0.003	0.005
2003-010	R0.15	1	60,000	350	0.006	0.008	45,000	310	0.004	0.007	43,500	180	0.003	0.005
2003-015	R0.15	1.5	60,000	350	0.006	0.008	45,000	310	0.004	0.007	43,500	180	0.003	0.005
2003-020	R0.15	2	60,000	210	0.004	0.007	45,000	190	0.003	0.005	43,500	110	0.002	0.004
2003-030	R0.15	3	42,500	140	0.002	0.004	32,000	80	0.002	0.004	32,000	65	0.001	0.002
2004-005	R0.2	0.5	50,000	500	0.01	0.02	37,500	420	0.007	0.012	35,000	240	0.005	0.008
2004-010	R0.2	1	50,000	500	0.01	0.02	37,500	420	0.007	0.012	35,000	240	0.005	0.008
2004-015	R0.2	1.5	50,000	500	0.01	0.02	37,500	420	0.007	0.012	35,000	240	0.005	0.008
2004-020	R0.2	2	50,000	500	0.01	0.02	37,500	420	0.007	0.012	35,000	240	0.005	0.008
2004-030	R0.2	3	40,000	250	0.005	0.008	31,900	210	0.004	0.008	30,500	160	0.003	0.005
2004-040	R0.2	4	32,000	180	0.003	0.005	25,500	150	0.002	0.004	24,300	120	0.002	0.004
2005-010	R0.25	1	44,000	650	0.015	0.04	33,000	530	0.01	0.02	30,000	300	0.007	0.01
2005-015	R0.25	1.5	44,000	650	0.015	0.04	33,000	530	0.01	0.02	30,000	300	0.007	0.01
2005-020	R0.25	2	44,000	650	0.015	0.04	33,000	530	0.01	0.02	30,000	300	0.007	0.01
2005-025	R0.25	2.5	44,000	650	0.015	0.04	33,000	530	0.01	0.02	30,000	300	0.007	0.01
2005-030	R0.25	3	40,000	500	0.01	0.02	31,000	400	0.007	0.01	28,550	230	0.005	0.008
2005-040	R0.25	4	32,700	180	0.005	0.015	27,150	150	0.003	0.008	25,650	100	0.002	0.005
2006-010	R0.3	1	40,000	1,400	0.045	0.15	30,000	1,500	0.03	0.13	26,500	1,000	0.015	0.09
2006-015	R0.3	1.5	40,000	1,100	0.03	0.13	30,000	1,200	0.02	0.1	26,500	800	0.01	0.075
2006-020	R0.3	2	40,000	1,100	0.03	0.13	30,000	1,200	0.02	0.1	26,500	800	0.01	0.075
2006-025	R0.3	2.5	40,000	800	0.02	0.1	30,000	800	0.015	0.09	26,500	520	0.008	0.065
2006-030	R0.3	3	40,000	800	0.02	0.1	30,000	800	0.015	0.09	26,500	520	0.008	0.065
2006-040	R0.3	4	40,000	500	0.015	0.09	30,000	500	0.01	0.075	26,500	340	0.006	0.05
2006-050	R0.3	5	32,000	400	0.01	0.075	25,000	390	0.007	0.05	23,000	260	0.005	0.04
2006-060	R0.3	6	24,000	300	0.007	0.06	21,000	320	0.005	0.04	19,500	210	0.004	0.03
2008-020	R0.4	2	35,000	1,600	0.06	0.21	27,000	1,600	0.04	0.17	23,500	1,000	0.02	0.12
2008-030	R0.4	3	35,000	1,400	0.05	0.19	27,000	1,400	0.03	0.15	23,500	900	0.015	0.1
2008-040	R0.4	4	35,000	1,200	0.04	0.17	27,000	1,200	0.025	0.135	23,500	600	0.012	0.095
2008-050	R0.4	5	31,500	900	0.03	0.15	25,000	900	0.02	0.12	22,000	500	0.01	0.085
2008-060	R0.4	6	28,000	600	0.02	0.12	23,000	600	0.012	0.095	20,500	400	0.006	0.065
2010-020	R0.5	2	30,000	1,750	0.2	0.4	24,000	2,000	0.1	0.3	21,000	1,750	0.05	0.2
2010-025	R0.5	2.5	30,000	1,750	0.2	0.4	24,000	2,000	0.1	0.3	21,000	1,750	0.05	0.2
2010-030	R0.5	3	30,000	1,750	0.1	0.3	24,000	2,000	0.05	0.2	21,000	1,750	0.03	0.17
2010-040	R0.5	4	30,000	1,750	0.1	0.3	24,000	2,000	0.05	0.2	21,000	1,750	0.03	0.17
2010-050	R0.5	5	30,000	1,750	0.1	0.3	24,000	2,000	0.05	0.2	21,000	1,750	0.03	0.17
2010-060	R0.5	6	30,000	1,150	0.06	0.23	21,500	1,250	0.03	0.17	19,700	1,050	0.025	0.15
2010-080	R0.5	8	24,000	800	0.025	0.155	18,500	580	0.015	0.12	18,400	480	0.015	0.12
2015-030	R0.75	3	30,000	2,450	0.25	0.55	17,000	2,000	0.12	0.4	15,000	1,750	0.06	0.29
2015-040	R0.75	4	30,000	2,450	0.25	0.55	17,000	2,000	0.12	0.4	15,000	1,750	0.06	0.29
2015-060	R0.75	6	30,000	2,450	0.15	0.45	17,000	2,000	0.07	0.31	15,000	1,750	0.04	0.24
2015-080	R0.75	8	23,500	1,300	0.1	0.37	15,000	1,250	0.045	0.25	14,000	1,050	0.03	0.21

∅3mm Shank V Series

UDC-PCD Series

CBN Series

Square

Long Neck Square

Radius

Long Neck Radius

Taper Neck Radius

Ball / Long Shank Ball

Long Neck Ball

Taper Neck Ball

Taper

Barrel

Spiral V Cutter

Drill

Technical Data

VHSLB Milling Conditions

2 Flutes

WORK MATERIAL			HARDENED STEELS HAP72 (66-70HRC)			
Model Number	Radius of Ball Nose (mm)	Effective Length (mm)	Spindle Speed (min ⁻¹)	Feed Rate (mm/min)	a _p Axial Depth (mm)	a _e Radial Depth (mm)
2001-003	R0.05	0.3	36,000	22	0.002	0.002
2002-003	R0.1	0.3	45,000	65	0.002	0.003
2002-005	R0.1	0.5	45,000	65	0.002	0.003
2002-0075	R0.1	0.75	45,000	65	0.002	0.003
2002-010	R0.1	1	45,000	65	0.002	0.003
2003-005	R0.15	0.5	32,500	90	0.003	0.005
2003-0075	R0.15	0.75	32,500	90	0.003	0.005
2003-010	R0.15	1	32,500	90	0.003	0.005
2003-015	R0.15	1.5	32,500	90	0.003	0.005
2003-020	R0.15	2	32,500	55	0.002	0.004
2003-030	R0.15	3	24,000	30	0.001	0.002
2004-005	R0.2	0.5	26,250	120	0.005	0.008
2004-010	R0.2	1	26,250	120	0.005	0.008
2004-015	R0.2	1.5	26,250	120	0.005	0.008
2004-020	R0.2	2	26,250	120	0.005	0.008
2004-030	R0.2	3	22,800	80	0.003	0.005
2004-040	R0.2	4	18,200	60	0.002	0.004
2005-010	R0.25	1	22,500	150	0.007	0.01
2005-015	R0.25	1.5	22,500	150	0.007	0.01
2005-020	R0.25	2	22,500	150	0.007	0.01
2005-025	R0.25	2.5	22,500	150	0.007	0.01
2005-030	R0.25	3	21,400	115	0.005	0.008
2005-040	R0.25	4	19,900	50	0.002	0.005
2006-010	R0.3	1	20,000	500	0.015	0.09
2006-015	R0.3	1.5	20,000	400	0.01	0.075
2006-020	R0.3	2	20,000	400	0.01	0.075
2006-025	R0.3	2.5	20,000	260	0.008	0.065
2006-030	R0.3	3	20,000	260	0.008	0.065
2006-040	R0.3	4	20,000	170	0.006	0.05
2006-050	R0.3	5	18,000	130	0.005	0.04
2006-060	R0.3	6	15,000	105	0.004	0.03
2008-020	R0.4	2	17,500	500	0.02	0.12
2008-030	R0.4	3	17,500	450	0.015	0.1
2008-040	R0.4	4	17,500	300	0.012	0.095
2008-050	R0.4	5	16,500	250	0.01	0.085
2008-060	R0.4	6	15,500	200	0.006	0.065
2010-020	R0.5	2	16,000	875	0.05	0.2
2010-025	R0.5	2.5	16,000	875	0.05	0.2
2010-030	R0.5	3	16,000	875	0.03	0.17
2010-040	R0.5	4	16,000	875	0.03	0.17
2010-050	R0.5	5	16,000	875	0.03	0.17
2010-060	R0.5	6	14,500	525	0.025	0.15
2010-080	R0.5	8	13,800	240	0.015	0.12
2015-030	R0.75	3	11,250	875	0.06	0.29
2015-040	R0.75	4	11,250	875	0.06	0.29
2015-060	R0.75	6	11,250	875	0.04	0.24
2015-080	R0.75	8	10,500	525	0.03	0.21

- Ø3mm Shank V Series
- UDC-PCD Series
- CBN Series
- Square
- Long Neck Square
- Radius
- Long Neck Radius
- Taper Neck Radius
- Ball / Long Shank Ball
- Long Neck Ball
- Taper Neck Ball
- Taper
- Barrel
- Spiral V Cutter
- Drill
- Technical Data

VHSLB Milling Conditions

WORK MATERIAL			COPPER OFC / TPC				CARBON STEELS S45C / S50C (~225HB)				ALLOY STEELS SK / SCM / SUS (225~325HB)			
Model Number	Radius of Ball Nose (mm)	Effective Length (mm)	Spindle Speed (min-1)	Feed Rate (mm/min)	a_p Axial Depth (mm)	a_e Radial Depth (mm)	Spindle Speed (min-1)	Feed Rate (mm/min)	a_p Axial Depth (mm)	a_e Radial Depth (mm)	Spindle Speed (min-1)	Feed Rate (mm/min)	a_p Axial Depth (mm)	a_e Radial Depth (mm)
2020-030	R1	3	22,000	2,140	0.232	0.54	30,000	2,000	0.21	0.42	30,000	2,000	0.21	0.42
2020-040	R1	4	22,000	2,140	0.232	0.54	30,000	2,000	0.21	0.42	30,000	2,000	0.21	0.42
2020-060	R1	6	22,000	2,140	0.232	0.54	30,000	2,000	0.21	0.42	30,000	2,000	0.21	0.42
2020-080	R1	8	22,000	1,920	0.185	0.36	30,000	2,000	0.18	0.36	30,000	2,000	0.18	0.36
2030-060	R1.5	6	15,000	2,890	0.278	0.54	24,000	2,500	0.32	0.9	24,000	2,500	0.32	0.9
2030-080	R1.5	8	15,000	2,890	0.278	0.54	24,000	2,500	0.32	0.9	24,000	2,500	0.32	0.9

WORK MATERIAL			PREHARDENED STEELS / HARDENED STEELS NAK / STAVAX (~55HRC)				HARDENED STEELS SKD11 (55~62HRC)				HARDENED STEELS HAP10 (62~66HRC)			
Model Number	Radius of Ball Nose (mm)	Effective Length (mm)	Spindle Speed (min-1)	Feed Rate (mm/min)	a_p Axial Depth (mm)	a_e Radial Depth (mm)	Spindle Speed (min-1)	Feed Rate (mm/min)	a_p Axial Depth (mm)	a_e Radial Depth (mm)	Spindle Speed (min-1)	Feed Rate (mm/min)	a_p Axial Depth (mm)	a_e Radial Depth (mm)
2020-030	R1	3	28,000	2,900	0.3	0.7	14,000	2,100	0.15	0.5	12,250	1,800	0.08	0.35
2020-040	R1	4	28,000	2,900	0.3	0.7	14,000	2,100	0.15	0.5	12,250	1,800	0.08	0.35
2020-060	R1	6	28,000	2,900	0.2	0.6	14,000	2,100	0.1	0.4	12,250	1,800	0.06	0.3
2020-080	R1	8	28,000	2,900	0.2	0.6	14,000	2,100	0.1	0.4	12,250	1,800	0.06	0.3
2030-060	R1.5	6	21,000	3,000	0.4	1	10,500	2,200	0.2	0.7	9,200	1,900	0.12	0.55
2030-080	R1.5	8	21,000	3,000	0.4	1	10,500	2,200	0.2	0.7	9,200	1,900	0.12	0.55

WORK MATERIAL			HARDENED STEELS HAP72 (66~70HRC)			
Model Number	Radius of Ball Nose (mm)	Effective Length (mm)	Spindle Speed (min-1)	Feed Rate (mm/min)	a_p Axial Depth (mm)	a_e Radial Depth (mm)
2020-030	R1	3	9,200	900	0.08	0.35
2020-040	R1	4	9,200	900	0.08	0.35
2020-060	R1	6	9,200	900	0.06	0.3
2020-080	R1	8	9,200	900	0.06	0.3
2030-060	R1.5	6	6,900	950	0.12	0.55
2030-080	R1.5	8	6,900	950	0.12	0.55

Note:

- Decrease the feed rate more than 50% from the milling parameters when slot milling.
- Decrease both spindle speed and feed rate proportionally when the milling parameters exceed the machine's maximum spindle speed, or when the tool is chattering and heats up to a red color.
- Every coolant offers stable milling.
- Recommend wet coolant for Copper.

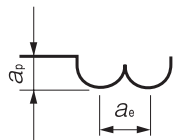

Long neck ball end mill R0.5 x Effective length 6mm

The comparison example of different shank diameter between $\phi 3\text{mm}$ & $\phi 4\text{mm}$

Comparison of roughness and reflection of the aspherical surface (Finishing process).

The upper surface of the square prism was processed aspherically, and the surface roughness and reflection were compared. We obtained the same results as the $\phi 4\text{mm}$ shank in terms of surface roughness and reflection.

<Condition>

Work material : HAP10(64HRC)

Coolant : Air blow

Tool holder : Hydraulic chuck

(Overhang : 2mm of the shank part)

Milling shape : Aspherical surface ($5\text{mm} \times 5\text{mm}$) R25

Cycle time : about 26 min.

n : 29,600 min^{-1}

V_r : 500 mm/min

a_p : 0.015 mm

a_e : 0.006 mm

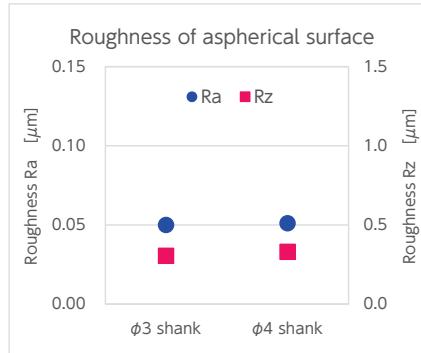

<Aspherical shape photos>

$\phi 3\text{mm}$ shank VHSLB

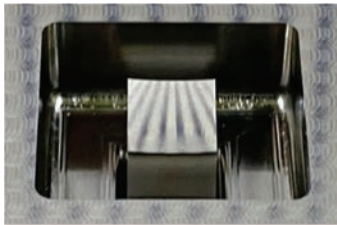

$\phi 4\text{mm}$ shank HSLB

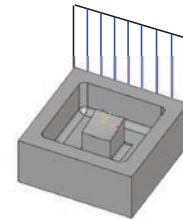
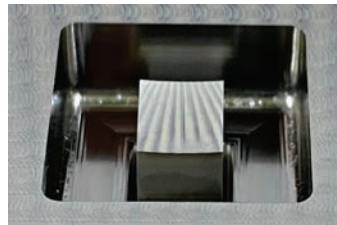

Image of the time of shooting

* These photos were taken as shown in the image on the right so that the blue line printed on the paper would be reflected.

$\phi 3\text{mm}$ Shank
V Series

UDC-PCD
Series

CBN
Series

Square

Long Neck
Square

Radius

Long Neck
Radius

Taper Neck
Radius

Ball / Long
Shank Ball

Long Neck
Ball

Taper Neck
Ball

Taper

Barrel

Spiral
V Cutter

Drill

Technical Data

VCSELB

Value Series UTCOAT Longneck Ball

UTCOAT 2 Flutes Short Shank Long Neck Ball End Mills

NEW

Super
MG

UT
COAT

Shank Dia
0/-0.003



R0.05~R0.075



R0.1~R1.5

Back Taper
Geometry

Except for R0.05~R0.15

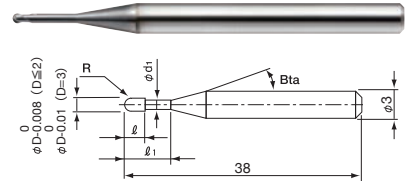

The shank taper angle shown is not an exact value and to avoid contact with the work piece, we recommend the user controls the precise value of this angle. Shank taper angle should not make contact with the work piece.

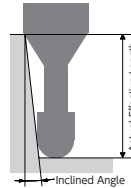

Radius of Ball Nose	Diameter Tolerance	Ball Radius Accuracy	Helix Angle
R0.05 ~ R0.075	0/-0.008	± 0.002	0°
R0.1 ~ R0.75		± 0.003	30°
R1	± 0.004		
R1.5	0/-0.01	± 0.005	

Material Applications (★ Highly Recommended ● Recommended ○ Suggested)

CARBON STEELS S45C S55C	ALLOY STEELS SK / SCM SUS	PREHARDENED STEELS NAK HPM	HARDENED STEELS					CAST IRON	ALUMINUM ALLOYS	GRAPHITE	COPPER	PLASTICS	GLASS FILLED PLASTICS	TITANIUM ALLOYS	HEAT RESISTANT ALLOYS	CEMENTED CARBIDE	HARD BRITTLE (NON-METALLIC) MATERIALS
			~50HRC	~55HRC	~60HRC	~65HRC	~70HRC										
●	●	●	●	●				○	●		●						

Total 30 models

Unit (mm)

Model Number	Radius of Ball Nose R	Effective Length ℓ_1	Length of Cut ℓ	Neck Diameter ϕd_1	Shank Taper Angle Bta	Effective Length by Inclined Angles					Suggested Retail Price ¥
						30°	1°	1° 30'	2°	3°	
VCSELB 2001-003	R0.05	0.3	0.08	0.094	11°	0.34	0.36	0.38	0.41	0.46	5,820
VCSELB 20015-003	R0.075	0.3	0.12	0.14	11°	0.37	0.39	0.41	0.43	0.48	6,730
VCSELB 2002-005	R0.1	0.5	0.16	0.18	11°	0.64	0.67	0.70	0.73	0.82	4,050
VCSELB 2002-010	R0.1	1	0.16	0.18	11°	1.16	1.21	1.28	1.34	1.50	4,050
VCSELB 2003-010	R0.15	1	0.24	0.28	11°	1.16	1.21	1.27	1.33	1.49	3,990
VCSELB 2003-020	R0.15	2	0.24	0.28	11°	2.20	2.30	2.42	2.55	2.85	4,280
VCSELB 2003-030	R0.15	3	0.24	0.28	11°	3.25	3.40	3.58	3.77	4.22	4,390
VCSELB 2004-010	R0.2	1	0.32	0.38	11°	1.16	1.21	1.26	1.32	1.47	2,740
VCSELB 2004-020	R0.2	2	0.32	0.38	11°	2.20	2.30	2.41	2.54	2.83	2,850
VCSELB 2004-030	R0.2	3	0.32	0.38	11°	3.24	3.40	3.57	3.76	4.20	3,140
VCSELB 2004-040	R0.2	4	0.32	0.38	11°	4.29	4.50	4.72	4.97	5.57	3,420
VCSELB 2005-020	R0.25	2	0.4	0.48	11°	2.19	2.29	2.40	2.52	2.81	2,740
VCSELB 2005-030	R0.25	3	0.4	0.48	11°	3.24	3.39	3.56	3.74	4.18	2,740
VCSELB 2005-040	R0.25	4	0.4	0.48	11°	4.29	4.49	4.71	4.96	5.55	2,740
VCSELB 2006-020	R0.3	2	0.48	0.58	11°	2.19	2.29	2.39	2.51	2.79	2,110
VCSELB 2006-030	R0.3	3	0.48	0.58	11°	3.24	3.39	3.55	3.73	4.16	2,170
VCSELB 2006-040	R0.3	4	0.48	0.58	11°	4.28	4.48	4.70	4.95	5.53	2,230
VCSELB 2006-060	R0.3	6	0.48	0.58	11°	6.38	6.68	7.02	7.39	8.27	2,230
VCSELB 2008-020	R0.4	2	0.64	0.78	11°	2.19	2.28	2.38	2.49	2.76	2,110
VCSELB 2008-040	R0.4	4	0.64	0.78	11°	4.28	4.47	4.69	4.93	5.50	2,230
VCSELB 2008-060	R0.4	6	0.64	0.78	11°	6.37	6.67	7.00	7.37	8.23	2,230

UTCOAT 2 Flutes Short Shank Long Neck Ball End Mills

Model Number	Radius of Ball Nose R	Effective Length l_1	Length of Cut l	Neck Diameter ϕd_1	Shank Taper Angle Bta	Effective Length by Inclined Angles					Suggested Retail Price ¥
						30°	1°	1° 30'	2°	3°	
VCSELB 2010-030	R0.5	3	0.8	0.97	11°	3.26	3.40	3.55	3.73	4.13	2,000
VCSELB 2010-040	R0.5	4	0.8	0.97	11°	4.31	4.50	4.71	4.94	5.50	2,000
VCSELB 2010-050	R0.5	5	0.8	0.97	11°	5.35	5.60	5.87	6.16	6.87	2,000
VCSELB 2010-060	R0.5	6	0.8	0.97	11°	6.40	6.70	7.02	7.38	8.24	2,170
VCSELB 2015-040	R0.75	4	1.2	1.46	11°	4.25	4.42	4.62	4.84	5.35	2,050
VCSELB 2015-060	R0.75	6	1.2	1.46	11°	6.34	6.62	6.93	7.27	8.09	2,050
VCSELB 2020-040	R1	4	1.6	1.96	11°	4.24	4.40	4.58	4.78	5.26	2,000
VCSELB 2020-060	R1	6	1.6	1.96	11°	6.33	6.60	6.89	7.22	8.00	2,000
VCSELB 2030-060	R1.5	6	2.4	2.93	—	No Interference	No Interference	No Interference	No Interference	No Interference	2,170

2 Flutes

Ø3mm Shank V Series

UDC-PCD Series

CBN Series

Square

Square
Long Neck Square

Radius

Radius
Long Neck Radius
Taper Neck Radius

Ball

Ball / Long Shank Ball
Long Neck Ball
Taper Neck Ball

Taper

Taper

Barrel

Barrel

Spiral

Spiral V Cutter

Drill

Drill

Technical Data

Technical Data

VCSELB Milling Conditions

WORK MATERIAL			COPPER / ALUMINUM ALLOYS				CARBON STEELS / ALLOY STEELS S45C / S50C / SK / SCM (~325HB)				PREHARDENED STEELS NAK80 / STAVAX / HPM38 (30~45HRC)			
Model Number	Radius of Ball Nose (mm)	Effective Length (mm)	Spindle Speed (min ⁻¹)	Feed Rate (mm/min)	a _p Axial Depth (mm)	a _e Radial Depth (mm)	Spindle Speed (min ⁻¹)	Feed Rate (mm/min)	a _p Axial Depth (mm)	a _e Radial Depth (mm)	Spindle Speed (min ⁻¹)	Feed Rate (mm/min)	a _p Axial Depth (mm)	a _e Radial Depth (mm)
2001-003	R0.05	0.3	54,000	85	0.004	0.004	54,000	85	0.004	0.004	48,000	55	0.002	0.002
20015-003	R0.075	0.3	54,000	160	0.007	0.009	54,000	160	0.007	0.009	48,000	90	0.004	0.004
2002-005	R0.1	0.5	60,000	350	0.008	0.024	60,000	350	0.008	0.016	60,000	300	0.008	0.024
2002-010	R0.1	1	60,000	250	0.006	0.018	60,000	250	0.005	0.015	60,000	250	0.006	0.018
2003-010	R0.15	1	43,000	450	0.01	0.03	43,000	450	0.008	0.024	54,000	400	0.01	0.03
2003-020	R0.15	2	40,000	300	0.006	0.018	40,000	300	0.006	0.018	50,000	300	0.007	0.021
2003-030	R0.15	3	38,000	200	0.004	0.012	38,000	200	0.004	0.012	42,000	200	0.004	0.012
2004-010	R0.2	1	35,000	1,200	0.03	0.09	35,000	1,200	0.02	0.04	50,000	650	0.025	0.075
2004-020	R0.2	2	35,000	600	0.015	0.045	35,000	600	0.011	0.033	50,000	500	0.015	0.045
2004-030	R0.2	3	35,000	400	0.01	0.03	35,000	400	0.008	0.024	42,000	400	0.01	0.03
2004-040	R0.2	4	35,000	300	0.005	0.015	35,000	300	0.005	0.015	35,000	300	0.005	0.015
2005-020	R0.25	2	34,000	800	0.025	0.075	34,000	800	0.023	0.046	45,000	700	0.022	0.066
2005-030	R0.25	3	32,000	550	0.016	0.048	32,000	550	0.012	0.036	41,000	550	0.014	0.042
2005-040	R0.25	4	31,000	450	0.012	0.036	31,000	450	0.01	0.03	35,000	450	0.01	0.03
2006-020	R0.3	2	33,000	1,400	0.045	0.135	33,000	1,400	0.036	0.072	40,000	1,200	0.045	0.09
2006-030	R0.3	3	33,000	900	0.035	0.105	33,000	900	0.025	0.066	40,000	800	0.03	0.075
2006-040	R0.3	4	31,000	700	0.027	0.081	31,000	700	0.02	0.06	35,000	560	0.022	0.066
2006-060	R0.3	6	24,000	380	0.012	0.036	24,000	380	0.012	0.036	24,000	380	0.01	0.03
2008-020	R0.4	2	30,000	2,200	0.1	0.3	30,000	1,800	0.06	0.12	35,000	1,800	0.07	0.14
2008-040	R0.4	4	30,000	1,400	0.07	0.21	30,000	1,300	0.04	0.1	35,000	1,300	0.05	0.12
2008-060	R0.4	6	27,000	900	0.04	0.12	27,000	900	0.025	0.075	27,000	800	0.03	0.09
2010-030	R0.5	3	30,000	1,800	0.11	0.33	24,000	1,600	0.07	0.14	30,000	1,500	0.08	0.16
2010-040	R0.5	4	30,000	1,700	0.09	0.27	24,000	1,500	0.065	0.13	30,000	1,300	0.075	0.15
2010-050	R0.5	5	30,000	1,600	0.08	0.24	24,000	1,400	0.06	0.12	30,000	1,200	0.07	0.14
2010-060	R0.5	6	30,000	1,400	0.06	0.18	18,000	1,200	0.04	0.12	30,000	1,100	0.06	0.12
2015-040	R0.75	4	30,000	1,800	0.14	0.42	30,000	1,500	0.11	0.22	30,000	1,600	0.11	0.22
2015-060	R0.75	6	30,000	1,800	0.12	0.36	23,000	1,300	0.1	0.2	30,000	1,400	0.1	0.2
2020-040	R1	4	30,000	2,000	0.2	0.6	30,000	2,000	0.21	0.42	30,000	2,000	0.2	0.6
2020-060	R1	6	30,000	2,000	0.2	0.6	30,000	2,000	0.21	0.42	30,000	2,000	0.2	0.6
2030-060	R1.5	6	24,000	2,500	0.32	0.9	24,000	2,500	0.32	0.9	24,000	2,500	0.3	0.9

φ3mm Shank V Series

UDC-PCD Series

CBN Series

Square
Long Neck Square

Radius

Radius
Long Neck Radius
Taper Neck Radius

Ball / Long Shank Ball

Ball
Long Neck Ball
Taper Neck Ball

Taper

Barrel

Spiral V Cutter

Drill

Technical Data

VCSELB Milling Conditions

WORK MATERIAL			HARDENED STEELS STAVAX / HPM38 / SKD61 (45~55HRC)			
Model Number	Radius of Ball Nose (mm)	Effective Length (mm)	Spindle Speed (min ⁻¹)	Feed Rate (mm/min)	a_p Axial Depth (mm)	a_e Radial Depth (mm)
2001-003	R0.05	0.3	48,000	55	0.002	0.002
20015-003	R0.075	0.3	48,000	90	0.004	0.004
2002-005	R0.1	0.5	60,000	300	0.006	0.018
2002-010	R0.1	1	60,000	220	0.005	0.015
2003-010	R0.15	1	43,000	400	0.007	0.021
2003-020	R0.15	2	40,000	300	0.005	0.015
2003-030	R0.15	3	38,000	200	0.004	0.008
2004-010	R0.2	1	35,000	650	0.015	0.045
2004-020	R0.2	2	35,000	400	0.01	0.03
2004-030	R0.2	3	35,000	330	0.007	0.021
2004-040	R0.2	4	35,000	250	0.005	0.015
2005-020	R0.25	2	32,000	700	0.016	0.048
2005-030	R0.25	3	31,000	500	0.012	0.036
2005-040	R0.25	4	30,000	390	0.01	0.03
2006-020	R0.3	2	30,000	1,200	0.036	0.054
2006-030	R0.3	3	30,000	900	0.026	0.052
2006-040	R0.3	4	28,000	600	0.018	0.054
2006-060	R0.3	6	24,000	380	0.008	0.024
2008-020	R0.4	2	25,000	1,700	0.07	0.1
2008-040	R0.4	4	25,000	1,200	0.045	0.09
2008-060	R0.4	6	23,000	800	0.023	0.069
2010-030	R0.5	3	21,500	1,400	0.08	0.12
2010-040	R0.5	4	21,500	1,300	0.075	0.1
2010-050	R0.5	5	21,500	1,200	0.06	0.09
2010-060	R0.5	6	21,500	1,100	0.05	0.1
2015-040	R0.75	4	18,000	1,400	0.11	0.17
2015-060	R0.75	6	15,000	1,200	0.1	0.16
2020-040	R1	4	16,000	1,300	0.17	0.5
2020-060	R1	6	14,000	1,100	0.15	0.4
2030-060	R1.5	6	14,000	1,400	0.25	0.76

Note:

- Decrease the feed rate more than 50% from the milling parameters when slot milling.
- Decrease both spindle speed and feed rate proportionally when the milling parameters exceed the machine's maximum spindle speed, or when the tool is chattering and heats up to a red color.
- Recommend oil coolant for Stainless Steels and Heat Resistant Alloys.
- Recommend wet coolant for Copper.

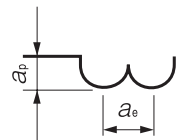

2 Flutes

Ø3mm Shank
V Series

UDC-PCD
Series

CBN
Series

Square

Square
Long Neck
Square

Radius

Radius
Long Neck
Radius
Taper Neck
Radius

Ball

Ball / Long
Shank Ball
Long Neck
Ball
Taper Neck
Ball

Taper

Taper

Barrel

Spiral
V Cutter

Drill

Technical Data

VDLCLB

Value Series DLCCOAT Longneck Ball

DLCCOAT 2 Flutes Short Shank Long Neck Ball End Mills

NEW

Super
MG

DLC



R
±0.002

R
±0.003

Shank Dia
0/-0.003

R0.05~R0.2

R0.25~R1

Back Taper
Geometry

Except for R0.05~R0.15

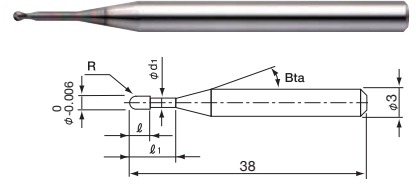
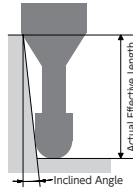

The shank taper angle shown is not an exact value and to avoid contact with the work piece, we recommend the user controls the precise value of this angle. Shank taper angle should not make contact with the work piece.

Label Sample



#001 φD0.997 R+0.001/-0.001

Diameter and Ball R accuracy measurements are printed on the label to support High Precision milling.

Material Applications (★ Highly Recommended ● Recommended ○ Suggested)

	CARBON STEELS S45C S55C	ALLOY STEELS SK / SCM SUS	PREHARDENED STEELS NAK HPM	HARDENED STEELS					CAST IRON	ALUMINUM ALLOYS	GRAPHITE	COPPER	PLASTICS	GLASS FILLED PLASTICS	TITANIUM ALLOYS	HEAT RESISTANT ALLOYS	CEMENTED CARBIDE	HARD BRITTLE (NON-METALLIC) MATERIALS
				~50HRC	~55HRC	~60HRC	~65HRC	~70HRC										
									●		★							

Total 32 models

Unit (mm)

Model Number	Radius of Ball Nose R	Effective Length l_1	Length of Cut l	Neck Diameter ϕd_1	Shank Taper Angle Bta	Effective Length by Inclined Angles					Suggested Retail Price ¥
						30°	1°	1° 30'	2°	3°	
VDLCLB 2001-003	R0.05	0.3	0.08	0.092	11°	0.35	0.37	0.39	0.41	0.46	5,300
VDLCLB 2001-005	R0.05	0.5	0.08	0.092	11°	0.56	0.59	0.62	0.66	0.74	5,500
VDLCLB 2002-005	R0.1	0.5	0.16	0.18	11°	0.64	0.67	0.70	0.74	0.83	4,250
VDLCLB 2002-010	R0.1	1	0.16	0.18	11°	1.17	1.22	1.28	1.35	1.51	4,450
VDLCLB 2002-015	R0.1	1.5	0.16	0.18	11°	1.68	1.77	1.86	1.95	2.19	4,600
VDLCLB 2003-010	R0.15	1	0.24	0.28	11°	1.16	1.22	1.27	1.34	1.49	4,450
VDLCLB 2003-020	R0.15	2	0.24	0.28	11°	2.21	2.31	2.43	2.55	2.86	4,800
VDLCLB 2004-010	R0.2	1	0.32	0.38	11°	1.16	1.21	1.27	1.33	1.48	3,850
VDLCLB 2004-020	R0.2	2	0.32	0.38	11°	2.20	2.31	2.42	2.54	2.84	3,950
VDLCLB 2004-030	R0.2	3	0.32	0.38	11°	3.25	3.40	3.57	3.76	4.21	4,000
VDLCLB 2004-040	R0.2	4	0.32	0.38	11°	4.30	4.50	4.73	4.98	5.58	4,100
VDLCLB 2005-020	R0.25	2	0.4	0.48	11°	2.20	2.30	2.41	2.53	2.82	3,800
VDLCLB 2005-030	R0.25	3	0.4	0.48	11°	3.25	3.40	3.57	3.75	4.19	3,850
VDLCLB 2005-040	R0.25	4	0.4	0.48	11°	4.29	4.50	4.72	4.97	5.56	3,950
VDLCLB 2006-020	R0.3	2	0.48	0.58	11°	2.20	2.30	2.40	2.52	2.80	2,950
VDLCLB 2006-030	R0.3	3	0.48	0.58	11°	3.25	3.39	3.56	3.74	4.17	3,050
VDLCLB 2006-040	R0.3	4	0.48	0.58	11°	4.29	4.49	4.71	4.96	5.54	3,100
VDLCLB 2006-050	R0.3	5	0.48	0.58	11°	5.34	5.59	5.87	6.18	6.91	3,200
VDLCLB 2006-060	R0.3	6	0.48	0.58	11°	6.39	6.69	7.03	7.40	8.28	3,250
VDLCLB 2008-030	R0.4	3	0.64	0.78	11°	3.24	3.38	3.54	3.72	4.14	3,050
VDLCLB 2008-040	R0.4	4	0.64	0.78	11°	4.29	4.48	4.70	4.94	5.51	3,100
VDLCLB 2008-060	R0.4	6	0.64	0.78	11°	6.38	6.68	7.01	7.38	8.24	3,200
VDLCLB 2010-020	R0.5	2	0.8	0.97	11°	2.22	2.31	2.41	2.52	2.77	2,900
VDLCLB 2010-030	R0.5	3	0.8	0.97	11°	3.27	3.41	3.56	3.73	4.14	2,900
VDLCLB 2010-040	R0.5	4	0.8	0.97	11°	4.32	4.51	4.72	4.95	5.51	2,900
VDLCLB 2010-060	R0.5	6	0.8	0.97	11°	6.41	6.70	7.03	7.39	8.25	2,950
VDLCLB 2010-080	R0.5	8	0.8	0.97	11°	8.50	8.90	9.34	9.83	10.99	3,100
VDLCLB 2015-040	R0.75	4	1.2	1.45	11°	4.26	4.43	4.63	4.85	5.36	2,950
VDLCLB 2015-060	R0.75	6	1.2	1.45	11°	6.35	6.63	6.94	7.28	8.10	2,950
VDLCLB 2020-040	R1	4	1.6	1.95	11°	4.25	4.41	4.59	4.79	5.27	3,050
VDLCLB 2020-060	R1	6	1.6	1.95	11°	6.34	6.61	6.90	7.23	8.01	3,050
VDLCLB 2020-080	R1	8	1.6	1.95	11°	8.43	8.80	9.21	9.67	No Interference	3,100

VDLCLB Milling Conditions

2 Flutes

WORK MATERIAL			COPPER / ALUMINUM ALLOY				TUNGSTEN COPPER			
Model Number	Radius of Ball Nose (mm)	Effective Length (mm)	Spindle Speed (min ⁻¹)	Feed Rate (mm/min)	a _p Axial Depth (mm)	a _e Radial Depth (mm)	Spindle Speed (min ⁻¹)	Feed Rate (mm/min)	a _p Axial Depth (mm)	a _e Radial Depth (mm)
2001-003	R0.05	0.3	43,600	220	0.01	0.01	32,700	160	0.008	0.008
2001-005	R0.05	0.5	43,600	160	0.007	0.007	32,700	110	0.005	0.005
2002-005	R0.1	0.5	43,600	550	0.025	0.05	32,700	380	0.02	0.04
2002-010	R0.1	1	43,600	440	0.02	0.04	32,700	270	0.015	0.03
2002-015	R0.1	1.5	32,900	250	0.015	0.03	24,700	120	0.008	0.02
2003-010	R0.15	1	43,600	760	0.03	0.07	32,700	550	0.03	0.07
2003-020	R0.15	2	39,200	390	0.02	0.03	29,400	200	0.01	0.02
2004-010	R0.2	1	43,600	1,090	0.05	0.1	32,700	760	0.04	0.08
2004-020	R0.2	2	43,600	650	0.035	0.06	32,700	380	0.02	0.05
2004-030	R0.2	3	35,000	470	0.02	0.04	29,200	230	0.01	0.03
2004-040	R0.2	4	27,300	270	0.008	0.015	19,600	110	0.005	0.01
2005-020	R0.25	2	43,600	870	0.08	0.15	32,700	550	0.08	0.15
2005-030	R0.25	3	38,200	650	0.06	0.1	29,500	390	0.06	0.08
2005-040	R0.25	4	32,700	440	0.04	0.08	24,000	220	0.025	0.05
2006-020	R0.3	2	43,600	1,750	0.12	0.2	32,700	1,310	0.12	0.2
2006-030	R0.3	3	43,600	1,090	0.1	0.14	32,700	760	0.08	0.1
2006-040	R0.3	4	32,700	760	0.07	0.1	27,300	440	0.04	0.06
2006-050	R0.3	5	29,500	650	0.05	0.08	24,000	330	0.02	0.04
2006-060	R0.3	6	27,300	550	0.04	0.06	21,800	220	0.01	0.03
2008-030	R0.4	3	43,600	2,180	0.15	0.3	32,700	1,530	0.15	0.3
2008-040	R0.4	4	38,200	1,750	0.12	0.2	29,500	1,090	0.1	0.16
2008-060	R0.4	6	32,700	1,090	0.08	0.15	21,800	550	0.05	0.1
2010-020	R0.5	2	39,100	2,740	0.25	0.4	30,000	2,050	0.25	0.4
2010-030	R0.5	3	39,100	2,740	0.25	0.4	30,000	1,960	0.25	0.4
2010-040	R0.5	4	39,100	2,350	0.2	0.4	29,500	1,560	0.2	0.4
2010-060	R0.5	6	34,500	1,840	0.14	0.3	26,200	1,150	0.1	0.25
2010-080	R0.5	8	27,300	1,090	0.12	0.2	19,600	550	0.06	0.1
2015-040	R0.75	4	25,500	2,270	0.3	0.6	21,300	1,700	0.3	0.6
2015-060	R0.75	6	25,500	2,040	0.3	0.6	21,300	1,530	0.3	0.6
2020-040	R1	4	18,700	2,490	0.45	0.8	14,000	1,500	0.45	0.8
2020-060	R1	6	18,700	2,080	0.45	0.8	14,000	1,250	0.45	0.8
2020-080	R1	8	18,700	1,800	0.4	0.8	13,500	1,200	0.4	0.8

- Ø3mm Shank V Series
- UDC-PCD Series
- CBN Series
- Square
- Long Neck Square
- Radius
- Long Neck Radius
- Taper Neck Radius
- Ball / Long Shank Ball
- Long Neck Ball
- Taper Neck Ball
- Taper
- Barrel
- Spiral V Cutter
- Drill
- Technical Data

Note:

- Decrease the feed rate more than 50% from the milling parameters when slot milling.
- Decrease both spindle speed and feed rate proportionally when the milling parameters exceed the machine's maximum spindle speed, or when chattering occurs.
- Recommend wet coolant for Copper, Aluminum alloy and Tungsten-Copper.

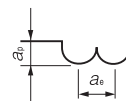

Milling Example of Copper Electrode Model (Tough Pitch Copper)

R1 x Effective length 8mm

The comparison example of VDLCLB($\phi 3$ shank) and DLCLB($\phi 4$ shank)

Comparison of tool wearing

<Condition>

Work material : Tough Pitch Copper
 Coolant : Oil mist
 Milling shape : □20 mm x 20 mm x height 8 mm

<Tool>*1

VDLCLB 2020-080 ($\phi 3$ shank)

DLCLB 2020-080 ($\phi 4$ shank)

*1 1 for roughing to semi-finishing, 1 for finishing
 total 2 ea.

*2 Both models are set so that the overhang of shank is 2 mm.

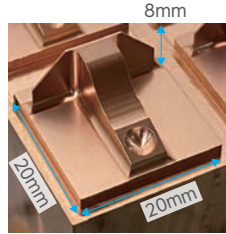

Milling shape

$\phi 3$ mm shank
VDLCLB

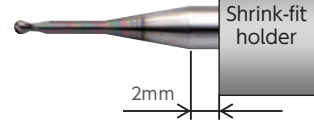

$\phi 4$ mm shank
DLCLB

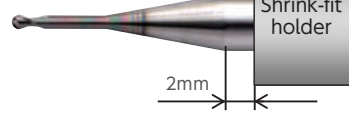

VDLCLB
Milling Video

No.	Milling Process	Spindle speed (min ⁻¹)	Feed rate (mm/min)	ap (mm)	ae (mm)	Allowance (mm)	Cycle time/ 1 pc
1	Roughing	18,700	1,800	0.4	0.8	0.08	14 min. 6 sec.
2	Semi-finishing	18,700	1,800	0.05	0.05	0.03	1 h 17 min. 24 sec.
3	Finishing	18,700/ 30,000(Bottom)	900	0.03	0.03	0	1 h 17 min. 0 sec.
Total							2 h 48 min. 30 sec.

VDLCLB($\phi 3$ shank)
Milling application

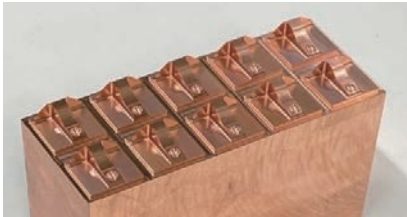

DLCLB($\phi 4$ shank)
Milling application

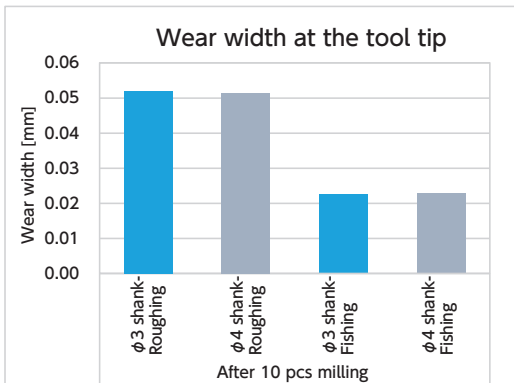
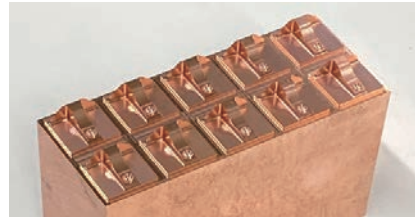

[Tool after 10pcs milling]

VDLCLB
($\phi 3$ shank)

DLCLB
($\phi 4$ shank)

Roughing to
Semi-finishing

Cycle time:
15 h 15 min



Finishing

Cycle time:
12 h 50 min.

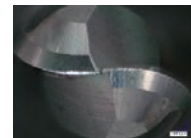

No difference of tool wearing with regard to the shank diameter gap.

Comparison of dimensional accuracy and roughness

Measuring for dimensional accuracy of vertical wall and roughness of concave surface.

Measuring position for dimensional accuracy (Left)

Measuring position for roughness

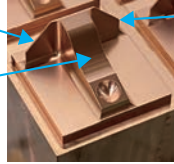

Measuring position for dimensional accuracy (Right)

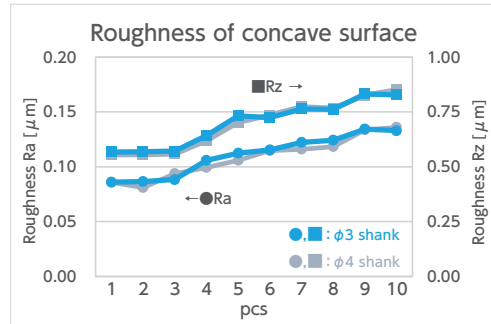
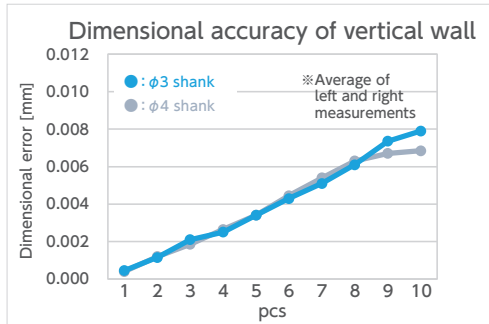

Both the dimensional accuracy and roughness gave very similar results, with no difference with regard to the shank diameter gap.

- φ3mm Shank V Series
- UDC-PCD Series
- CBN Series
- Square
- Long Neck Square
- Radius
- Long Neck Radius
- Taper Neck Radius
- Ball / Long Shank Ball
- Long Neck Ball
- Taper Neck Ball
- Taper
- Barrel
- Spiral V Cutter
- Drill
- Technical Data

VHLS

Value Series HARDMAX Longneck Square

HARDMAX 2 Flutes Short Shank Long Neck Square End Mills

NEW

Super
MG

HARD
MAX



Shank Dia
0/-0.003

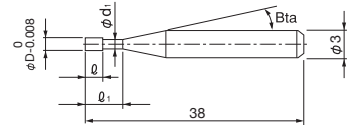
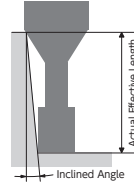

The shank taper angle shown is not an exact value and to avoid contact with the work piece, we recommend the user controls the precise value of this angle. Shank taper angle should not make contact with the work piece.

Material Applications (★ Highly Recommended ● Recommended ○ Suggested)

CARBON STEELS S45C S55C	ALLOY STEELS SK / SCM SUS	PREHARDENED STEELS NAK HPM	HARDENED STEELS					CAST IRON	ALUMINUM ALLOYS	GRAPHITE	COPPER	PLASTICS	GLASS FILLED PLASTICS	TITANIUM ALLOYS	HEAT RESISTANT ALLOYS	CEMENTED CARBIDE	HARD BRITTLE (NON-METALLIC) MATERIALS
			~50HRC	~55HRC	~60HRC	~65HRC	~70HRC										
○	○	●	●	●	○		○			○			○	○			

Total 30 models

Unit (mm)

Model Number	Outside Diameter ϕ	Effective Length ℓ_1	Length of Cut ℓ	Neck Diameter ϕd_1	Shank Taper Angle $B\theta a$	Effective Length by Inclined Angles					Suggested Retail Price ¥
						30°	1°	1° 30'	2°	3°	
VHLS 2001-003	0.1	0.3	0.1	0.093	11°	0.35	0.37	0.39	0.42	0.48	5,580
VHLS 2002-005	0.2	0.5	0.3	0.18	16°	0.68	0.72	0.76	0.80	0.87	3,660
VHLS 2002-010	0.2	1	0.3	0.18	16°	1.21	1.27	1.32	1.37	1.48	3,960
VHLS 2003-010	0.3	1	0.4	0.28	16°	1.25	1.32	1.39	1.45	1.56	3,240
VHLS 2003-015	0.3	1.5	0.4	0.28	16°	1.77	1.86	1.94	2.02	2.17	3,240
VHLS 2003-020	0.3	2	0.4	0.28	16°	2.30	2.41	2.50	2.59	2.78	3,960
VHLS 2004-015	0.4	1.5	0.6	0.38	16°	1.85	1.97	2.07	2.17	2.34	2,340
VHLS 2004-020	0.4	2	0.6	0.38	16°	2.38	2.52	2.64	2.75	2.96	2,340
VHLS 2004-030	0.4	3	0.6	0.38	16°	3.44	3.61	3.75	3.88	4.18	2,340
VHLS 2004-040	0.4	4	0.6	0.38	16°	4.49	4.69	4.85	5.02	5.40	2,340
VHLS 2005-015	0.5	1.5	0.7	0.49	16°	1.92	2.06	2.19	2.30	2.51	1,800
VHLS 2005-020	0.5	2	0.7	0.49	16°	2.46	2.62	2.76	2.89	3.13	1,800
VHLS 2005-025	0.5	2.5	0.7	0.49	16°	2.99	3.18	3.33	3.47	3.74	1,800
VHLS 2005-030	0.5	3	0.7	0.49	16°	3.52	3.73	3.89	4.04	4.35	1,800
VHLS 2005-040	0.5	4	0.7	0.49	16°	4.58	4.82	5.01	5.18	5.57	1,800
VHLS 2005-060	0.5	6	0.7	0.49	16°	6.69	6.97	7.21	7.46	8.02	1,800
VHLS 2006-020	0.6	2	0.9	0.59	16°	2.52	2.71	2.88	3.03	3.30	1,800
VHLS 2006-030	0.6	3	0.9	0.59	16°	3.60	3.83	4.02	4.20	4.52	1,800
VHLS 2006-040	0.6	4	0.9	0.59	16°	4.67	4.93	5.15	5.34	5.75	1,800
VHLS 2006-060	0.6	6	0.9	0.59	16°	6.78	7.10	7.36	7.62	8.19	1,800
VHLS 2008-030	0.8	3	1.2	0.79	16°	3.60	3.83	4.02	4.20	4.52	1,980
VHLS 2008-040	0.8	4	1.2	0.79	16°	4.67	4.93	5.15	5.34	5.75	1,980
VHLS 2008-060	0.8	6	1.2	0.79	16°	6.78	7.10	7.36	7.62	8.19	1,980
VHLS 2010-030	1	3	1.5	0.96	16°	3.71	3.92	4.10	4.26	4.59	1,800
VHLS 2010-040	1	4	1.5	0.96	16°	4.77	5.01	5.22	5.40	5.81	1,800
VHLS 2010-050	1	5	1.5	0.96	16°	5.82	6.09	6.32	6.54	7.03	1,800
VHLS 2010-060	1	6	1.5	0.96	16°	6.87	7.17	7.42	7.68	8.26	1,800
VHLS 2015-040	1.5	4	2.3	1.46	16°	4.17	4.31	4.46	4.61	4.96	1,920
VHLS 2015-060	1.5	6	2.3	1.46	16°	6.24	6.44	6.66	6.89	7.41	1,920
VHLS 2020-060	2	6	3	1.93	16°	6.29	6.49	6.71	6.95	7.47	1,920

VHLS Milling Conditions

WORK MATERIAL			COPPER OFC / TPC				CARBON STEELS S45C / S50C (~225HB)				ALLOY STEELS SK / SCM / SUS (225~325HB)			
Model Number	Outside Diameter (mm)	Effective Length (mm)	Spindle Speed (min ⁻¹)	Feed Rate (mm/min)	a _p Axial Depth (mm)	a _e Radial Depth (mm)	Spindle Speed (min ⁻¹)	Feed Rate (mm/min)	a _p Axial Depth (mm)	a _e Radial Depth (mm)	Spindle Speed (min ⁻¹)	Feed Rate (mm/min)	a _p Axial Depth (mm)	a _e Radial Depth (mm)
2001-003	0.1	0.3	50,000	170	0.018	0.035	50,000	170	0.005	0.035	50,000	160	0.005	0.035
2002-005	0.2	0.5	50,000	340	0.027	0.13	50,000	340	0.009	0.13	50,000	310	0.008	0.13
2002-010	0.2	1	50,000	290	0.018	0.035	50,000	290	0.007	0.035	50,000	260	0.006	0.035
2003-010	0.3	1	50,000	560	0.045	0.101	50,000	560	0.015	0.101	50,000	500	0.013	0.101
2003-015	0.3	1.5	50,000	460	0.041	0.05	50,000	460	0.013	0.05	50,000	410	0.011	0.05
2003-020	0.3	2	41,500	350	0.032	0.023	41,500	350	0.01	0.023	41,500	320	0.009	0.023
2004-015	0.4	1.5	50,000	660	0.054	0.095	50,000	660	0.016	0.095	50,000	640	0.015	0.095
2004-020	0.4	2	50,000	610	0.045	0.052	50,000	610	0.014	0.052	50,000	580	0.013	0.052
2004-030	0.4	3	44,500	510	0.027	0.018	44,500	510	0.009	0.018	43,600	450	0.008	0.018
2004-040	0.4	4	41,000	440	0.018	0.008	41,000	440	0.006	0.008	38,000	360	0.005	0.008
2005-015	0.5	1.5	50,000	1,020	0.09	0.139	50,000	1,020	0.029	0.139	50,000	870	0.027	0.139
2005-020	0.5	2	50,000	900	0.081	0.098	50,000	900	0.025	0.098	50,000	760	0.023	0.098
2005-025	0.5	2.5	50,000	780	0.072	0.057	50,000	780	0.021	0.057	47,000	650	0.019	0.057
2005-030	0.5	3	44,200	660	0.05	0.037	44,200	660	0.016	0.037	39,900	530	0.015	0.037
2005-040	0.5	4	40,600	580	0.041	0.016	40,600	580	0.013	0.016	36,100	460	0.012	0.016
2005-060	0.5	6	33,400	420	0.023	0.005	33,400	420	0.007	0.005	28,500	320	0.006	0.005
2006-020	0.6	2	50,000	1,240	0.117	0.18	50,000	1,240	0.038	0.18	50,000	930	0.034	0.18
2006-030	0.6	3	50,000	990	0.09	0.075	50,000	990	0.03	0.075	44,000	740	0.026	0.075
2006-040	0.6	4	41,300	740	0.063	0.03	41,300	740	0.021	0.03	34,700	550	0.018	0.03
2006-060	0.6	6	32,100	520	0.036	0.01	32,100	520	0.012	0.01	27,000	390	0.01	0.01
2008-030	0.8	3	41,200	1,050	0.171	0.15	41,200	1,050	0.053	0.15	34,500	790	0.049	0.15
2008-040	0.8	4	37,100	930	0.14	0.08	37,100	930	0.044	0.08	31,100	700	0.04	0.08
2008-060	0.8	6	28,800	680	0.077	0.024	28,800	680	0.025	0.024	24,200	510	0.022	0.024
2010-030	1	3	37,900	1,340	0.257	0.263	37,900	1,340	0.067	0.263	31,500	990	0.072	0.263
2010-040	1	4	34,100	1,170	0.212	0.195	34,100	1,170	0.067	0.195	28,400	870	0.06	0.195
2010-050	1	5	30,300	1,000	0.167	0.127	30,300	1,000	0.053	0.127	25,300	750	0.048	0.127
2010-060	1	6	26,500	850	0.122	0.058	26,500	850	0.039	0.058	22,100	630	0.035	0.058
2015-040	1.5	4	26,600	1,340	0.378	0.462	26,600	1,340	0.12	0.462	22,100	1,000	0.109	0.462
2015-060	1.5	6	22,800	1,120	0.297	0.293	22,800	1,120	0.094	0.293	19,000	840	0.085	0.293
2020-060	2	6	20,300	1,350	0.338	0.926	20,300	1,350	0.107	0.926	17,400	1,030	0.097	0.926

2 Flutes

- Ø3mm Shank V Series
- UDC-PCD Series
- CBN Series
- Square
 - Long Neck Square
- Radius
 - Long Neck Radius
 - Taper Neck Radius
- Ball
 - Ball / Long Shank Ball
 - Long Neck Ball
 - Taper Neck Ball
- Taper
 - Taper
- Barrel
- Spiral V Cutter
- Drill
- Technical Data

VHLS Milling Conditions

WORK MATERIAL			PREHARDENED STEELS / HARDENED STEELS NAK / SKD (30~45HRC)				HARDENED STEELS SKD / SKT (45~55HRC)				HARDENED STEELS SKD / SKH (55~60HRC)			
Model Number	Outside Diameter (mm)	Effective Length (mm)	Spindle Speed (min ⁻¹)	Feed Rate (mm/min)	a _p Axial Depth (mm)	a _e Radial Depth (mm)	Spindle Speed (min ⁻¹)	Feed Rate (mm/min)	a _p Axial Depth (mm)	a _e Radial Depth (mm)	Spindle Speed (min ⁻¹)	Feed Rate (mm/min)	a _p Axial Depth (mm)	a _e Radial Depth (mm)
2001-003	0.1	0.3	50,000	140	0.004	0.035	50,000	90	0.002	0.035	30,000	10	0.002	0.08
2002-005	0.2	0.5	50,000	270	0.006	0.13	44,800	180	0.004	0.13	15,000	10	0.002	0.13
2002-010	0.2	1	50,000	230	0.004	0.035	40,800	160	0.002	0.035	15,000	10	0.002	0.035
2003-010	0.3	1	50,000	440	0.01	0.101	50,000	330	0.007	0.101	14,600	14	0.004	0.101
2003-015	0.3	1.5	50,000	360	0.009	0.05	42,700	260	0.006	0.05	14,600	13	0.004	0.05
2003-020	0.3	2	41,500	280	0.007	0.023	33,200	190	0.005	0.023	14,600	12	0.003	0.023
2004-015	0.4	1.5	48,100	470	0.012	0.095	38,500	320	0.008	0.095	14,300	17	0.004	0.095
2004-020	0.4	2	44,600	430	0.01	0.052	35,700	290	0.007	0.052	14,300	17	0.004	0.052
2004-030	0.4	3	37,500	340	0.006	0.018	30,000	230	0.005	0.018	14,300	16	0.003	0.018
2004-040	0.4	4	33,100	280	0.004	0.008	26,500	190	0.003	0.008	14,300	15	0.002	0.008
2005-015	0.5	1.5	46,500	610	0.02	0.139	37,300	410	0.015	0.139	14,000	20	0.008	0.139
2005-020	0.5	2	40,600	510	0.018	0.098	32,500	350	0.013	0.098	14,000	20	0.007	0.098
2005-025	0.5	2.5	34,700	410	0.016	0.057	27,700	290	0.011	0.057	14,000	20	0.006	0.057
2005-030	0.5	3	32,200	370	0.011	0.037	25,700	260	0.009	0.037	14,000	19	0.005	0.037
2005-040	0.5	4	29,700	330	0.009	0.016	23,700	230	0.007	0.016	14,000	18	0.004	0.016
2005-060	0.5	6	24,700	250	0.005	0.005	19,700	170	0.003	0.005	14,000	16	0.002	0.005
2006-020	0.6	2	39,100	600	0.026	0.18	31,300	410	0.019	0.18	12,000	23	0.01	0.18
2006-030	0.6	3	33,500	500	0.02	0.075	26,800	340	0.015	0.075	12,000	22	0.008	0.075
2006-040	0.6	4	27,900	390	0.014	0.03	22,300	270	0.01	0.03	12,000	21	0.005	0.03
2006-060	0.6	6	23,000	290	0.008	0.01	18,400	200	0.006	0.01	12,000	19	0.003	0.01
2008-030	0.8	3	26,200	530	0.038	0.15	21,000	370	0.027	0.15	8,000	21	0.016	0.15
2008-040	0.8	4	24,100	480	0.031	0.08	19,300	330	0.022	0.08	8,000	20	0.013	0.08
2008-060	0.8	6	19,800	370	0.017	0.024	15,800	250	0.012	0.024	8,000	18	0.007	0.024
2010-030	1	3	23,400	650	0.057	0.263	18,700	440	0.039	0.263	6,500	15	0.016	0.263
2010-040	1	4	21,500	580	0.047	0.195	17,200	400	0.033	0.195	6,500	15	0.015	0.195
2010-050	1	5	19,600	510	0.037	0.127	15,700	360	0.027	0.127	6,500	15	0.014	0.127
2010-060	1	6	17,600	440	0.027	0.058	14,100	310	0.02	0.058	6,500	14	0.012	0.058
2015-040	1.5	4	16,300	640	0.084	0.462	13,000	440	0.06	0.462	9,600	95	0.036	0.462
2015-060	1.5	6	14,400	550	0.066	0.293	11,500	380	0.047	0.293	9,600	60	0.028	0.293
2020-060	2	6	12,500	650	0.075	0.926	10,000	450	0.054	0.926	9,600	211	0.032	0.926

Note:

- Recommend using a non-contact measuring device to avoid damaging the precision tip point.
- Decrease both spindle speed and feed rate proportionally when the milling parameters exceed the machine's maximum spindle speed.
- Every coolant offers stable milling.
- Recommend oil coolant for Stainless Steels and Heat Resistant Alloys.
- Recommend wet coolant for Copper.

Side Milling

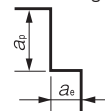

HARDMAX 2 Flutes Short Shank Long Neck Radius End Mills

NEW

Super
MG

HARD
MAX



Shank Dia
0/-0.003

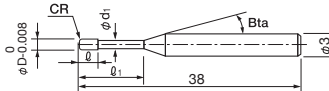
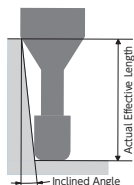

The shank taper angle shown is not an exact value and to avoid contact with the work piece, we recommend the user controls the precise value of this angle. Shank taper angle should not make contact with the work piece.

Material Applications (★ Highly Recommended ● Recommended ○ Suggested)

CARBON STEELS S45C S55C	ALLOY STEELS SK / SCM SUS	PREHARDENED STEELS NAK HPM	HARDENED STEELS					CAST IRON	ALUMINUM ALLOYS	GRAPHITE	COPPER	PLASTICS	GLASS FILLED PLASTICS	TITANIUM ALLOYS	HEAT RESISTANT ALLOYS	CEMENTED CARBIDE	HARD BRITTLE (NON-METALLIC) MATERIALS
			~50HRC	~55HRC	~60HRC	~65HRC	~70HRC										
○	○	●	●	●	●	○	○			●				○	○		

Total 24 models

Unit (mm)

Model Number	Outside Diameter φ	Corner Radius CR	Effective Length ℓ _e	Length of Cut ℓ	Neck Diameter φ _{d1}	Shank Taper Angle Bta	Effective Length by Inclined Angles					Suggested Retail Price ¥
							30°	1°	1° 30'	2°	3°	
VHLRS 2002-005-010	0.2	0.05	1	0.2	0.18	16°	1.21	1.26	1.32	1.37	1.47	6,160
VHLRS 2003-005-010	0.3	0.05	1	0.3	0.28	16°	1.25	1.32	1.38	1.44	1.55	5,940
VHLRS 2004-005-020	0.4	0.05	2	0.4	0.38	16°	2.38	2.52	2.63	2.74	2.94	3,960
VHLRS 2004-01-020	0.4	0.1	2	0.4	0.38	16°	2.38	2.51	2.63	2.73	2.93	3,960
VHLRS 2005-005-020	0.5	0.05	2	0.5	0.49	16°	2.45	2.62	2.76	2.88	3.12	3,220
VHLRS 2005-01-020	0.5	0.1	2	0.5	0.49	16°	2.45	2.61	2.75	2.88	3.11	3,220
VHLRS 2006-005-020	0.6	0.05	2	0.6	0.59	16°	2.52	2.71	2.87	3.02	3.29	3,220
VHLRS 2006-005-030	0.6	0.05	3	0.6	0.59	16°	3.59	3.82	4.02	4.19	4.51	3,220
VHLRS 2006-005-040	0.6	0.05	4	0.6	0.59	16°	4.66	4.93	5.14	5.34	5.74	3,220
VHLRS 2006-01-020	0.6	0.1	2	0.6	0.59	16°	2.51	2.70	2.86	3.01	3.28	3,220
VHLRS 2006-01-030	0.6	0.1	3	0.6	0.59	16°	3.59	3.82	4.01	4.18	4.50	3,220
VHLRS 2006-01-040	0.6	0.1	4	0.6	0.59	16°	4.66	4.92	5.14	5.33	5.72	3,220
VHLRS 2008-005-040	0.8	0.05	4	0.8	0.79	16°	4.66	4.93	5.14	5.34	5.74	3,670
VHLRS 2008-01-040	0.8	0.1	4	0.8	0.79	16°	4.66	4.92	5.14	5.33	5.72	3,670
VHLRS 2008-02-040	0.8	0.2	4	0.8	0.79	16°	4.65	4.91	5.13	5.32	5.70	3,670
VHLRS 2010-01-020	1	0.1	2	1	0.96	16°	2.64	2.80	2.95	3.09	3.34	3,120
VHLRS 2010-01-040	1	0.1	4	1	0.96	16°	4.76	5.00	5.20	5.39	5.79	3,120
VHLRS 2010-01-060	1	0.1	6	1	0.96	16°	6.87	7.16	7.41	7.67	8.24	3,390
VHLRS 2010-02-020	1	0.2	2	1	0.96	16°	2.63	2.79	2.94	3.07	3.32	3,120
VHLRS 2010-02-040	1	0.2	4	1	0.96	16°	4.76	4.99	5.19	5.38	5.77	3,120
VHLRS 2010-02-060	1	0.2	6	1	0.96	16°	6.86	7.15	7.40	7.65	8.21	3,390
VHLRS 2015-02-060	1.5	0.2	6	1.5	1.46	16°	6.23	6.43	6.64	6.86	7.36	3,330
VHLRS 2020-01-060	2	0.1	6	2	1.93	16°	6.28	6.49	6.70	6.93	7.45	3,330
VHLRS 2020-02-060	2	0.2	6	2	1.93	16°	6.28	6.48	6.69	6.92	7.43	3,330

φ3mm Shank
V Series

UDC-PCD
Series

CBN
Series

Square

Long Neck
Square

Radius

Long Neck
Radius

Taper Neck
Radius

Ball / Long
Shank Ball

Long Neck
Ball

Taper Neck
Ball

Taper

Barrel

Spiral
V Cutter

Drill

Technical Data

VHLRS Milling Conditions

WORK MATERIAL			COPPER OFC / TPC				CARBON STEELS S45C / S50C (~225HB)				ALLOY STEELS SK / SCM / SUS (225~325HB)			
Model Number	Outside Diameter (mm)	Effective Length (mm)	Spindle Speed (min ⁻¹)	Feed Rate (mm/min)	a _p Axial Depth (mm)	a _e Radial Depth (mm)	Spindle Speed (min ⁻¹)	Feed Rate (mm/min)	a _p Axial Depth (mm)	a _e Radial Depth (mm)	Spindle Speed (min ⁻¹)	Feed Rate (mm/min)	a _p Axial Depth (mm)	a _e Radial Depth (mm)
2002-005-010	0.2	1	55,000	200	0.027	0.02	55,000	200	0.009	0.02	55,000	200	0.009	0.02
2003-005-010	0.3	1	60,000	500	0.03	0.02	60,000	500	0.011	0.02	60,000	500	0.011	0.02
2004-005-020	0.4	2	40,400	540	0.042	0.054	40,400	450	0.017	0.045	40,400	450	0.017	0.045
2004-01-020	0.4	2	40,400	540	0.042	0.054	40,400	450	0.017	0.045	40,400	450	0.017	0.045
2005-005-020	0.5	2	39,900	1,000	0.075	0.108	39,900	830	0.044	0.117	39,900	830	0.044	0.117
2005-01-020	0.5	2	39,900	1,000	0.075	0.108	39,900	830	0.044	0.117	39,900	830	0.044	0.117
2006-005-020	0.6	2	28,600	610	0.114	0.162	28,600	510	0.015	0.219	28,600	510	0.015	0.219
2006-005-030	0.6	3	23,800	480	0.09	0.135	23,800	400	0.012	0.108	23,800	400	0.012	0.108
2006-005-040	0.6	4	20,400	400	0.063	0.108	20,400	330	0.008	0.104	20,400	330	0.008	0.104
2006-01-020	0.6	2	28,600	610	0.114	0.162	28,600	510	0.015	0.219	28,600	510	0.015	0.219
2006-01-030	0.6	3	23,800	480	0.09	0.135	23,800	400	0.012	0.108	23,800	400	0.012	0.108
2006-01-040	0.6	4	20,400	400	0.063	0.108	20,400	330	0.008	0.104	20,400	330	0.008	0.104
2008-005-040	0.8	4	17,500	540	0.132	0.198	17,500	450	0.021	0.117	17,500	450	0.021	0.117
2008-01-040	0.8	4	17,500	540	0.132	0.198	17,500	450	0.021	0.117	17,500	450	0.021	0.117
2008-02-040	0.8	4	17,500	540	0.132	0.198	17,500	450	0.021	0.117	17,500	450	0.021	0.117
2010-01-020	1	2	17,600	1,100	0.21	0.45	17,600	920	0.053	0.27	17,600	920	0.053	0.27
2010-01-040	1	4	13,800	980	0.201	0.405	13,800	820	0.045	0.27	13,800	820	0.045	0.27
2010-01-060	1	6	11,300	790	0.117	0.387	11,300	650	0.032	0.216	11,300	650	0.032	0.216
2010-02-020	1	2	17,600	1,100	0.21	0.45	17,600	920	0.053	0.27	17,600	920	0.053	0.27
2010-02-040	1	4	13,800	980	0.201	0.405	13,800	820	0.045	0.27	13,800	820	0.045	0.27
2010-02-060	1	6	11,300	790	0.117	0.387	11,300	650	0.032	0.216	11,300	650	0.032	0.216
2015-02-060	1.5	6	10,600	1,240	0.282	0.63	10,600	1,030	0.062	0.405	10,600	1,030	0.062	0.405
2020-01-060	2	6	12,800	1,220	0.321	0.855	12,800	1,020	0.065	0.81	12,800	1,020	0.065	0.81
2020-02-060	2	6	12,800	1,220	0.321	0.855	12,800	1,020	0.065	0.81	12,800	1,020	0.065	0.81

φ3mm Shank
V Series

UDC-PCD
Series

CBN
Series

Square
Long Neck
Square

Radius
Long Neck
Radius

Taper Neck
Radius

Ball / Long
Shank Ball
Long Neck
Ball
Taper Neck
Ball

Taper

Barrel

Spiral
V Cutter

Drill

Technical Data

VHLRS Milling Conditions

WORK MATERIAL			PREHARDENED STEELS / HARDENED STEELS NAK / SKD (30~45HRC)				HARDENED STEELS SKD / SKT (45~55HRC)				HARDENED STEELS SKD / SKH (55~65HRC)			
Model Number	Outside Diameter (mm)	Effective Length (mm)	Spindle Speed (min ⁻¹)	Feed Rate (mm/min)	a _p Axial Depth (mm)	a _e Radial Depth (mm)	Spindle Speed (min ⁻¹)	Feed Rate (mm/min)	a _p Axial Depth (mm)	a _e Radial Depth (mm)	Spindle Speed (min ⁻¹)	Feed Rate (mm/min)	a _p Axial Depth (mm)	a _e Radial Depth (mm)
2002-005-010	0.2	1	55,000	200	0.006	0.02	35,000	150	0.004	0.02	15,000	25	0.002	0.015
2003-005-010	0.3	1	60,000	500	0.007	0.02	35,000	350	0.005	0.02	22,000	35	0.004	0.015
2004-005-020	0.4	2	40,400	450	0.011	0.045	32,300	330	0.009	0.045	19,200	35	0.004	0.045
2004-01-020	0.4	2	40,400	450	0.011	0.045	32,300	330	0.009	0.045	19,200	35	0.004	0.045
2005-005-020	0.5	2	39,900	830	0.029	0.117	32,500	630	0.026	0.117	20,100	68	0.011	0.117
2005-01-020	0.5	2	39,900	830	0.029	0.117	32,500	630	0.026	0.117	20,100	68	0.011	0.117
2006-005-020	0.6	2	28,600	510	0.01	0.219	23,700	390	0.01	0.219	15,200	43	0.004	0.219
2006-005-030	0.6	3	23,800	400	0.008	0.108	19,700	300	0.007	0.108	12,600	33	0.003	0.108
2006-005-040	0.6	4	20,400	330	0.005	0.104	16,800	250	0.005	0.104	10,800	28	0.002	0.104
2006-01-020	0.6	2	28,600	510	0.01	0.219	23,700	390	0.01	0.219	15,200	43	0.004	0.219
2006-01-030	0.6	3	23,800	400	0.008	0.108	19,700	300	0.007	0.108	12,600	33	0.003	0.108
2006-01-040	0.6	4	20,400	330	0.005	0.104	16,800	250	0.005	0.104	10,800	28	0.002	0.104
2008-005-040	0.8	4	17,500	450	0.014	0.117	15,000	360	0.015	0.117	10,200	41	0.007	0.117
2008-01-040	0.8	4	17,500	450	0.014	0.117	15,000	360	0.015	0.117	10,200	41	0.007	0.117
2008-02-040	0.8	4	17,500	450	0.014	0.117	15,000	360	0.015	0.117	10,200	41	0.007	0.117
2010-01-020	1	2	17,600	920	0.035	0.27	15,300	750	0.04	0.27	10,900	89	0.02	0.27
2010-01-040	1	4	13,800	820	0.03	0.27	12,000	670	0.035	0.27	8,500	80	0.017	0.27
2010-01-060	1	6	11,300	650	0.021	0.216	9,800	540	0.024	0.216	7,000	64	0.012	0.216
2010-02-020	1	2	17,600	920	0.035	0.27	15,300	750	0.04	0.27	10,900	89	0.02	0.27
2010-02-040	1	4	13,800	820	0.03	0.27	12,000	670	0.035	0.27	8,500	80	0.017	0.27
2010-02-060	1	6	11,300	650	0.021	0.216	9,800	540	0.024	0.216	7,000	64	0.012	0.216
2015-02-060	1.5	6	10,600	1,030	0.041	0.405	9,700	900	0.055	0.405	7,400	117	0.03	0.405
2020-01-060	2	6	12,800	1,020	0.043	0.81	12,000	930	0.06	0.81	9,700	133	0.036	0.81
2020-02-060	2	6	12,800	1,020	0.043	0.81	12,000	930	0.06	0.81	9,700	133	0.036	0.81

2 Flutes

Ø3mm Shank V Series

UDC-PCD Series

CBN Series

Square
Long Neck Square

Radius
Long Neck Radius

Taper Neck Radius

Ball / Long Shank Ball

Long Neck Ball

Taper Neck Ball

Taper

Barrel

Spiral V Cutter

Drill

Technical Data

- Note:
- Decrease both spindle speed and feed rate proportionally when the milling parameters exceed the machine's maximum spindle speed.
 - Every coolant offers stable milling.
 - Recommend oil coolant for Stainless Steels and Heat Resistant Alloys.
 - Recommend wet coolant for Copper.

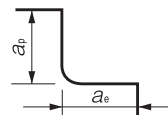

For Cemented Carbide and Hard Brittle Materials



UDC Series

ULTRA DIAMOND COAT



Features of UDC series

Optimized diamond coating for Cemented Carbide and Hard Brittle Materials

Coating Patented in Japan

Special high-performance Diamond film.
New Diamond coating developed to improve hardness and durability, with outstanding adhesion to the cutting tool.

Sandblasting tests the film adhesion and wear resistance

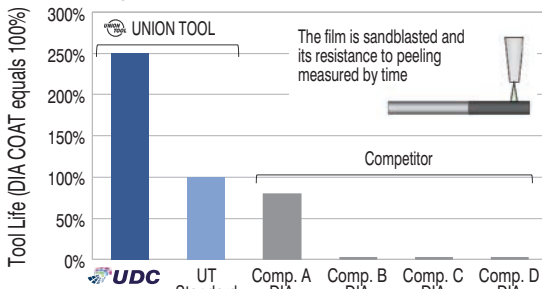

UNION TOOL's Diamond film that coated using the hot filament CVD method is developed to improve hardness and durability, with outstanding adhesion to the cutting tool. Using fine particle composition control, the UDC coating has dramatically improved hardness and durability.

Direct Milling of Cemented Carbide - No Grinding!

The normal expectation when milling Cemented Carbide would be a powdered swarf...



By using a deep cut into the Cemented Carbide, UDCB creates a "fan shaped" chip, just like cutting steel!

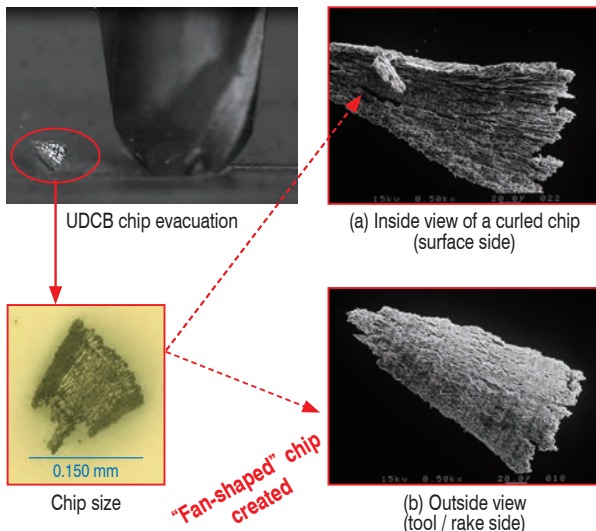

UDCB R0.5 Ball End Mill

Tool	UDCB 2010-0070 (R0.5 × 0.7)
Spindle Speed	30,000 min ⁻¹
Feed Rate	300 mm/min
a_p	0.1 mm
Coolant	Air Blow
Work Material	VM-40 (90HRA)

Choose by application

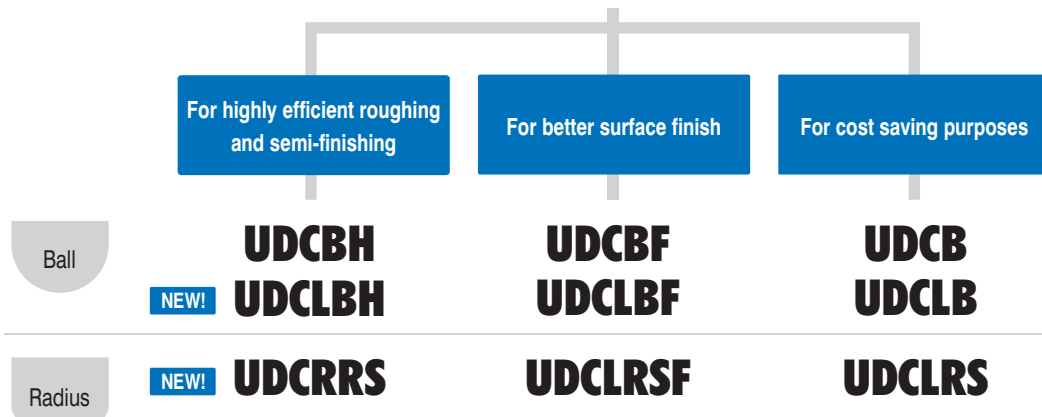

The long-awaited 3rd generation UDC!

UDC-H series

Patent pending

The best match for roughing and semi-finishing of cemented carbide.

Features of H series

- High-level Treatment!!** → Unbelievable milling performance
- High Speed!!** → Mill at surprisingly high feed rate
- High Material Removal Volume!!** → Highly improved material removal volume

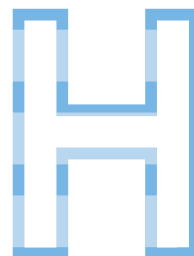

Attain both high efficiency and long tool life!

The key points

New generation edge treatment minimizes tool damage



Improved diamond coating to enhance wear resistance



- ø3mm Shank V Series
- UDC-PCD Series
- CBN Series
- Square
 - Square
 - Long Neck Square
- Radius
 - Radius
 - Long Neck Radius
 - Taper Neck Radius
- Ball
 - Ball / Long Shank Ball
 - Long Neck Ball
 - Taper Neck Ball
- Taper
 - Taper
- Barrel
- Spiral V Cutter
- Drill
- Technical Data

UDCBH



7.5 times
the efficiency

Over 4 times
the removal volume

Work Size : 50 x 50 x 10 mm

Pocket Size : Top ϕ 10 x Depth 3.5 mm

Material Removal Volume : 160 mm³ / Pocket

Coolant : Air Blow

UDCBH shows maximum tool performance under high-speed conditions.
Tool life may shorten when used at the same feed rate as before.



UDCBH
Milling example

Tool	UDCBH	UDCBF
Milling Conditions		
Spindle Speed	30,000 min ⁻¹	20,000 min ⁻¹
Feed Rate	1,500 mm/min	200 mm/min
a_p	0.1 mm	
a_e	0.3 mm	
Milling Results		
1 side 16 pockets	1 Tool Milling time 76 min	4 Tool Milling time 7 h 28 min
Tool after milling 4 pockets		
Tool after milling 16 pockets		

Still functional

3mm Shank
V Series

UDC-PCD
Series

CBN
Series

Square
Long Neck
Square

Radius

Radius
Long Neck
Radius
Taper Neck
Radius

Ball / Long
Shank Ball

Ball
Long Neck
Ball
Taper Neck
Ball

Taber
Taper

Barrel

Spiral
V Cutter

Drill

Technical Data

Hard Brittle Materials Electronic component assembly jig shaped milling with UDCBH R0.5 x L0.7

**Alumina Al₂O₃ (99.5%)
Zirconia ZrO₂ (94%)**

Alumina Al₂O₃ (99.5%)

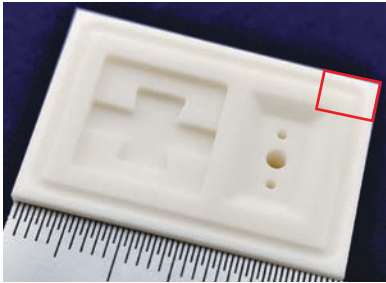

Work Size : 30 x 20 x 10 mm
Coolant : Water Soluble

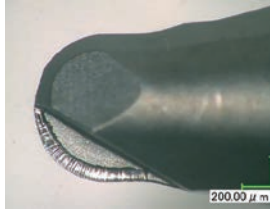

Zirconia ZrO₂ (94%)

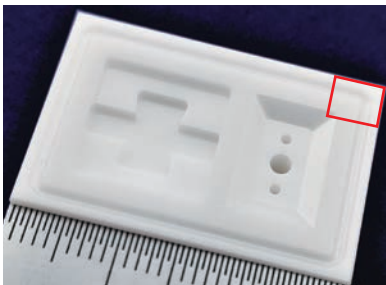

Work Size : 30 x 20 x 10 mm
Coolant : Water Soluble

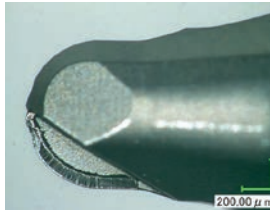

No	Process	Tool	Spindle Speed (min ⁻¹)	Feed Rate (mm/min)	a _p (mm)	a _e (mm)	Allowance (mm)	Cycle Time (h:m:s)
1	Slotting and inclined pocket roughing	UDCBH 2010-0070 (R0.5 × L0.7)	30,000	300	0.05	0.25	0.01/0.03	0:36:29
2	Slot finishing						0	0:19:17
3	2-stage pocket roughing	UDCLBF 2010-0200 (R0.5 × EL2)	30,000	300	0.028	0.028	0.03	0:52:42
4	Re-machining	UDCLRSF 2008-005024 (φ0.8 × CR0.05 × EL2.4)	30,000	175	0.023	0.5	0.03	0:18:26
5	Semi-finishing				0.02	0.25	0.01	0:51:09
6	Finishing				0.014	0.25	0	1:12:32
7	Drilling	UDCMX 2200-100 (φ2 × Flute Length 10)	2,400	5	0.15	—	—	0:03:15
8		UDCMX 2100-100 (φ1 × Flute Length 10)	5,000	7.5	0.05	—	—	0:10:44

Hole Depth 7 mm Total 4:24:34

- φ3mm Shank V Series
- UDC-PCD Series
- CBN Series
- Square
- Long Neck Square
- Radius
- Long Neck Radius
- Taper Neck Radius
- Ball / Long Shank Ball
- Long Neck Ball
- Taper Neck Ball
- Taper
- Barrel
- Spiral V Cutter
- Drill
- Technical Data

Cemented Carbide Hexalobular Comparison of efficiency and material removal volume with UDCBH / UDCBF R0.5 x L0.7 VM-40 (90 HRA)

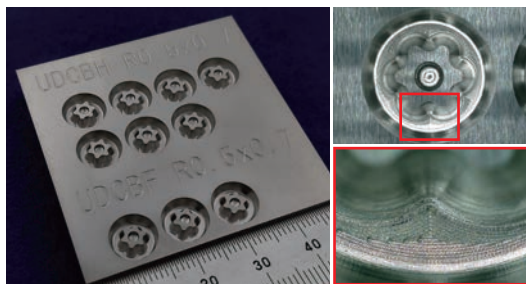

Model Size : $\phi 9 \times 2.2 \text{ mm}$ 91 mm³ / pc
Coolant : Air Blow

Less than 1/3 of the cycle time
More than twice the tool life of UDCBF

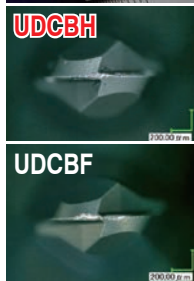

Tool damage at the time of machining 3 pieces

Tool	UDCBF		UDCBH	
	Hexalobular	Character engraving	Hexalobular	Character engraving
Model	Hexalobular	Character engraving	Hexalobular	Character engraving
Cycle Time / pc	38 min 21 sec	1 min 56 sec	11 min 50 sec	38 sec
Number of processed pieces / pc	3 pcs	—	7 pcs	—
Material Removal Volume	273 mm ³	—	637 mm ³	—
Spindle Speed	30,000 min ⁻¹	15,000 min ⁻¹	30,000 min ⁻¹	15,000 min ⁻¹
Feed Rate	300 mm/min	150 mm/min	900 mm/min	450 mm/min
Feed Rate 2	30 mm/min	30 mm/min	300 mm/min	300 mm/min
a_p	0.05 mm	0.05 mm	0.05 mm	0.05 mm
a_e	0.25 mm	—	0.25 mm	—

Efficiency
3.2 times
Tool life
2.3 times

Cemented Carbide Comparison of efficiency and material removal volume in roughing with UDCB / UDCBF / UDCBH VM-40 (90HRA)

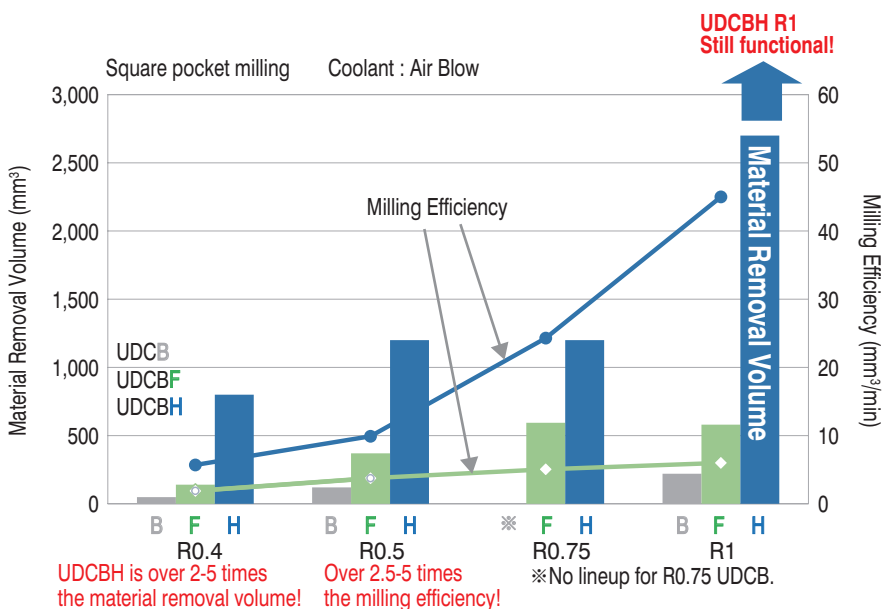

Cemented Carbide Connector shaped milling with UDCLBH R1 x EL4

VM-40 (90HRA)

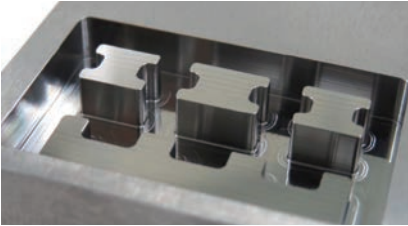

Model Size : 26 x 16 x 4 mm
Pocket Volume : 1,304 mm³
Coolant : Air Blow

R1 × EL4 Comparison of milling efficiency

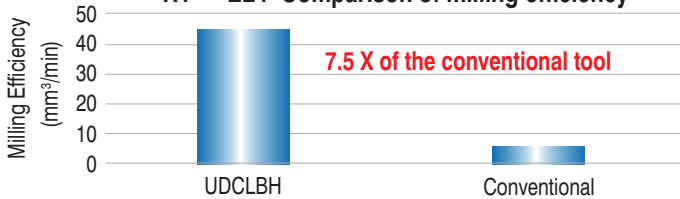

$$\text{Milling Efficiency} = \text{Feed Rate} \times a_p \times a_e$$

Tool after milling

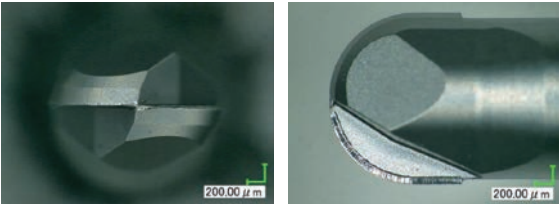

Less tool damage even with highly efficient milling!

No	Process	Tool No.	Tool	Spindle Speed (min ⁻¹)	Feed Rate (mm/min)	a_p (mm)	a_e (mm)	Allowance (mm)	Cycle Time (h:m:s)
1	Roughing	T1	UDCLBH 2020-0400 (R1 x EL4)	30,000	1,500	0.1	0.3	0.03	0:24:52
2	Corner Removal 1	T2	UDCLBH 2010-0400 (R0.5 x EL4)	30,000	400	0.05	0.11	0.03	0:33:12
3	Corner Removal 2	T3	UDCLRSF 2010-005040 (ϕ 1 x CR0.05 x EL4)	30,000	190	0.02	0.6	0.03	0:15:23
4	Top surface / Semi-finishing			30,000	190	—	0.6	0.01	0:03:11
5	Wall surface / Semi-finishing	T2	UDCLBH 2010-0400 (R0.5 x EL4)	30,000	400	0.05	0.22	0.01	0:38:22
6	Corner & Bottom surface / Semi-finishing	T3	UDCLRSF 2010-005040 (ϕ 1 x CR0.05 x EL4)	30,000	190	0.006	0.3	0.01	0:48:30
7	Top surface / Finishing	T4	UDCLRSF 2010-005040 (ϕ 1 x CR0.05 x EL4)	30,000	190	—	0.6	0	0:03:15
8	Wall surface / Finishing			30,000	375	0.25	—	0	0:08:17
9	Corner & Bottom surface / Finishing			30,000	190	0.014	0.3	0	0:46:09

Total 4pcs are used.

Total 3:41:11

- Ø3mm Shank V Series
- UDC-PCD Series
- CBN Series
- Square
- Long Neck Square
- Radius
- Long Neck Radius
- Taper Neck Radius
- Ball / Long Shank Ball
- Long Neck Ball
- Taper Neck Ball
- Taper
- Barrel
- Spiral V Cutter
- Drill
- Technical Data

The sharpest cutting edge in the UDC series

UDC-F series

The best choice for high quality milling surface

Features of F series

① UDC coating

Optimized coating for F series

② Special treatment for a sharp edge

Minimized edge chipping and the level of the gap

③ Chip pocket designed on tool tip

Excellent surface finish



Cemented Carbide Flat surface milling Comparison of edge chipping on work piece with UDCBH / UDCBF R0.4 × L0.56

VM-40 (90 HRA)

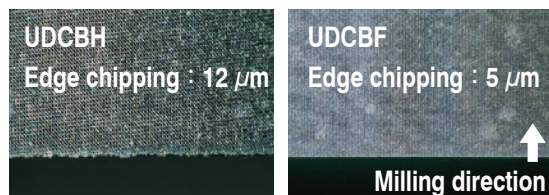

Tool	UDCBH	UDCBF
Spindle Speed	30,000 min ⁻¹	
Feed Rate	750 mm/min	250 mm/min
a_p	0.02 mm	
a_e	0.02 mm	
Coolant	Air Blow	

Improve efficiency and lower costs by using the right tool to meet your edge chipping requirements.

Cemented Carbide Indexable insert mold milling with UDCBF R0.5 × L0.7

VM-40 (90 HRA)

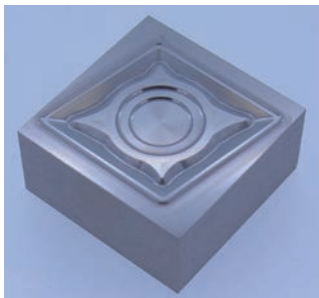

	Roughing	Finishing
Tool	UDCBF 2010-0070 (R0.5 × 0.7)	
Spindle Speed	30,000 min ⁻¹	
Feed Rate	300 mm/min	
a _p	0.05 mm	0.028 mm
a _e	0.25 mm	0.02 mm
Coolant	Air Blow	
Cycle Time	43 min	2 h 17 min
Material Removal Volume	86.3 mm ³	12.0 mm ³

※ One End Mill for both roughing and finishing processes. Total 2 tools are used.

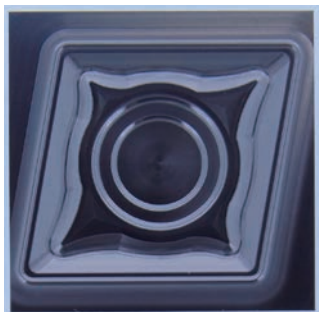

Tool after roughing

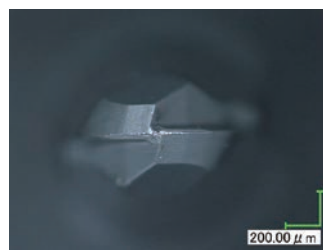

Tool after finishing

Surface Roughness

Excellent surface roughness!

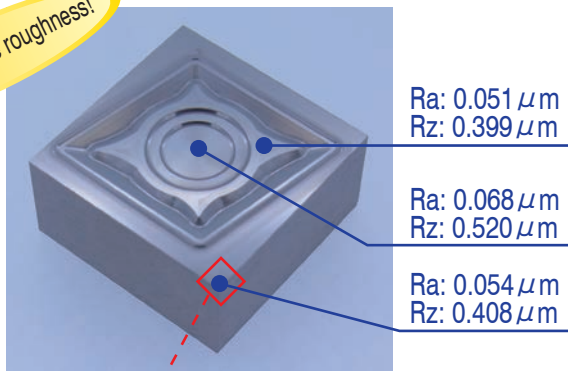

Size : 20 × 20 × 10 mm

Minimized edge chipping

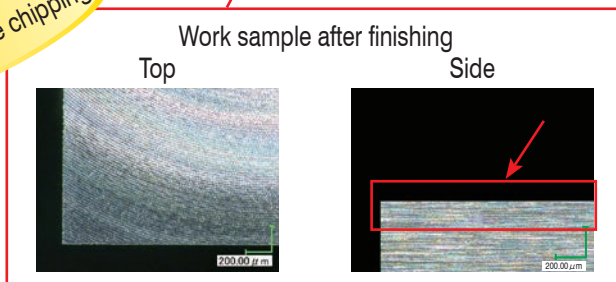

UDCBF Series
Indexable Insert Mold
Milling Video



- ∅3mm Shank V Series
- UDC-PCD Series
- CBN Series
- Square
- Long Neck Square
- Radius
- Long Neck Radius
- Taper Neck Radius
- Ball / Long Shank Ball
- Long Neck Ball
- Taper Neck Ball
- Taper
- Barrel
- Spiral V Cutter
- Drill
- Technical Data



Size R0.3~R1



UDCBH



Patent pending

Additional 2 models

Material Applications (★ Highly Recommended ● Recommended ○ Suggested)

Work Material																		
Carbon Steels	Alloy Steels	Prehardened Steels	Hardened Steels					Cast Iron	Aluminum Alloys	Graphite	Copper	Plastics	Glass Filled Plastics	Titanium Alloys	Heat Resistant Alloys	Cemented Carbide	Hard Brittle (Non-Metallic) Materials	
			~50HRC	~55HRC	~60HRC	~65HRC	~70HRC											
S45C S55C	SK / SCM SUS	NAK HPM														○	★	●

* Hard Brittle (Non-Metallic) Materials: Ceramics (Alumina, Zirconia, etc.), Glasses and etc.

Features

High efficiency and long life Ball End Mills for milling cemented carbide.
 High-level treatment to reduce cutting resistance and mill at a high feed rate.
 Wear resistance improved drastically with optimized Diamond coating.
 Best for roughing and semi-finishing.

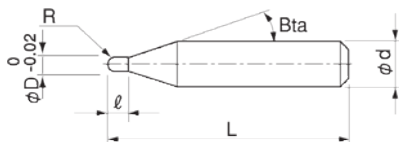

Label Sample



#001 $\phi D1.997 R+0.001/-0.001$

Diameter and Ball R accuracy measurements are printed on the label to support High Precision milling.

The shank taper angle shown is not an exact value and to avoid contact with the work piece, we recommend the user controls the precise value of this angle. Shank taper angle should not make contact with the work piece.

Total 6 models

Unit (mm)

Model Number	Radius of Ball Nose R	Length of Cut ℓ	Shank Taper Angle Bta	Overall Length L	Shank Diameter ϕd	Suggested Retail Price ¥
※ UDCBH 2006-0042	R0.3	0.42	16°	50	4	44,160
※ UDCBH 2007-0049	R0.35	0.49	16°	50	4	44,160
UDCBH 2008-0056	R0.4	0.56	16°	50	4	44,160
UDCBH 2010-0070	R0.5	0.7	16°	50	4	44,160
UDCBH 2015-0105	R0.75	1.05	16°	50	4	44,160
UDCBH 2020-0140	R1	1.4	16°	50	4	44,160

※Additional model

Milling Conditions for UDCBH

WORK MATERIAL			CEMENTED CARBIDE ($\geq 87\text{HRA}$)					CEMENTED CARBIDE ($< 87\text{HRA}$)					HARD BRITTLE MATERIALS				
Model Number	Radius of Ball Nose (mm)	Length of Cut (mm)	Spindle Speed (min^{-1})	Feed Rate (mm/min)	※ Feed Rate 2 (mm/min)	a_p (mm)	a_e (mm)	Spindle Speed (min^{-1})	Feed Rate (mm/min)	※ Feed Rate 2 (mm/min)	a_p (mm)	a_e (mm)	Spindle Speed (min^{-1})	Feed Rate (mm/min)	※ Feed Rate 2 (mm/min)	a_p (mm)	a_e (mm)
2006-0042	R0.3	0.42	30,000	600	200	0.03	0.14	30,000	900	300	0.17	0.03	30,000	200	20	0.03	0.14
2007-0049	R0.35	0.49	30,000	690	230	0.035	0.17	30,000	1,050	350	0.18	0.035	30,000	225	23	0.035	0.17
2008-0056	R0.4	0.56	30,000	750	250	0.04	0.19	30,000	1,250	420	0.19	0.04	30,000	250	25	0.04	0.19
2010-0070	R0.5	0.7	30,000	900	300	0.05	0.22	25,000	1,300	430	0.2	0.05	30,000	300	30	0.05	0.25
2015-0105	R0.75	1.05	30,000	1,200	400	0.075	0.27	19,000	1,450	480	0.23	0.07	24,000	400	45	0.075	0.27
2020-0140	R1	1.4	30,000	1,500	500	0.1	0.3	16,500	1,600	530	0.25	0.1	18,000	600	200	0.1	0.3

These milling parameters are based on VF-20, VM-40, VC-70, VU-70 (TAS standard) for Cemented Carbide, and Alumina for Hard Brittle Materials. These are for reference only.

Tool life may differ depending on the type of Cemented Carbide / Hard Brittle Materials.

For best result, fine parameter adjustments may be required, depending on the materials of Cemented Carbide / Hard Brittle Materials; milling shape and strategy; machine rigidity and spindle capability.

※ Feed Rate2: Feed rate of approach and *connection moves.

*Changing from one engagement point to the next.

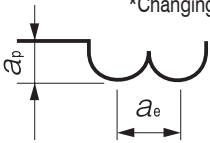

- Note:
- This application requires a high cutting force. A machine with poor rigidity and high vibration is not recommended.
 - Allow sufficient machine and spindle warm-up time for stability and to remove any expansion of the main spindle before running the program.
 - Tool setting length should achieve the least possible overhang.
 - Avoid contact with the coated area of the shank. This will prevent tip vibration and tool jamming in the collet / holder.
 - Run-out and vibration should be checked dynamically at the tool point while mounted in the machine and both should achieve the lowest level possible.
 - Use an inclined or helical approach (Recommended inclination angle: < 5 degree).
 - Decrease both spindle speed and feed rate proportionally.
 - Air blow is highly recommended for longer tool life. Both oil mist and oil coolant are alternatives.
 - Recommend water soluble coolant for Hard Brittle (Non-Metallic) Materials.
 - When milling some work pieces, heavier chips may be created. To evacuate these chips it is important to accurately position the coolant nozzle on the milling part.
 - Remove chips to prevent heat generation and ignition during milling process.
 - Protective gear, such as safety glasses and face guards are required when milling.
 - Chips / dust generated while milling can have adverse affects on the machine parts if they are not properly evacuated. Take steps to assure proper evacuation.
 - The tool life may shorten due to a large difference between the commanded feed speed and the actual machining speed caused by factors as machining model and machining machine.
 - Decrease both feed rate and feed rate 2 proportionally.
 - Tool damage may progress rapidly near the end of the tool life.

Ø3mm Shank
V Series

UDC-PCD
Series

CBN
Series

Square

Long Neck
Square

Radius

Long Neck
Radius

Taper Neck
Radius

Ball / Long
Shank Ball

Long Neck
Ball

Taper Neck
Ball

Taper

Barrel

Spiral
V Cutter

Drill

Technical Data



Size R0.1~R3



UDCBF



Patented in Japan, US, China, Korea, Germany, Switzerland, and Liechtenstein

Additional 1 model

Material Applications (★ Highly Recommended ● Recommended ○ Suggested)

Work Material																		
Carbon Steels	Alloy Steels	Prehardened Steels	Hardened Steels					Cast Iron	Aluminum Alloys	Graphite	Copper	Plastics	Glass Filled Plastics	Titanium Alloys	Heat Resistant Alloys	Cemented Carbide	Hard Brittle (Non-Metallic) Materials	
			~50HRC	~55HRC	~60HRC	~65HRC	~70HRC											
S45C S55C	SK / SCM SUS	NAK HPM														○	★	●

* Hard Brittle (Non-Metallic) Materials: Ceramics (Alumina, Zirconia, etc.), Glasses and etc.

Features

Ball type End Mills for milling Cemented Carbide and Hard Brittle (Non-Metallic) Materials. Upgraded version of UDCB. New Diamond coating and flute design increase material removal amount. Chip pocket designed on tool tip improves the surface finishing quality. Special cutting edge treatment helps to avoid the edge chipping & level gap. Recommended to use on semi-roughing & finishing process.

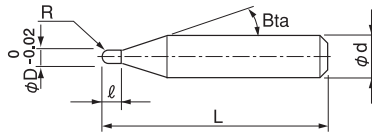

The shank taper angle shown is not an exact value and to avoid contact with the work piece, we recommend the user controls the precise value of this angle. Shank taper angle should not make contact with the work piece.

Label Sample



#001 φD0.797 R+0.003/0.000

Diameter and Ball R accuracy measurements are printed on the label to support High Precision milling.

Total 17 models

Unit (mm)

Model Number	Radius of Ball Nose R	Length of Cut ℓ	Shank Taper Angle Bta	Overall Length L	Shank Diameter φd	Suggested Retail Price ¥
UDCBF 2002-0014	RO.1	0.14	16°	50	4	47,000
UDCBF 2003-0021	RO.15	0.21	16°	50	4	47,000
UDCBF 2004-0028	RO.2	0.28	16°	50	4	42,800
UDCBF 2005-0035	RO.25	0.35	16°	50	4	42,800
UDCBF 2006-0042	RO.3	0.42	16°	50	4	38,400
UDCBF 2007-0049	RO.35	0.49	16°	50	4	38,400
UDCBF 2008-0056	RO.4	0.56	16°	50	4	38,400
UDCBF 2009-0063	RO.45	0.63	16°	50	4	38,400
UDCBF 2010-0070	RO.5	0.7	16°	50	4	38,400
UDCBF 2012-0084	RO.6	0.84	16°	50	4	38,400
UDCBF 2015-0105	RO.75	1.05	16°	50	4	38,400
UDCBF 2020-0140	R1	1.4	16°	50	4	38,400
※ UDCBF 2025-0175	R1.25	1.75	16°	50	4	42,300
UDCBF 2030-0210	R1.5	2.1	16°	60	6	42,300
UDCBF 2040-0280	R2	2.8	16°	60	6	42,300
UDCBF 2050-0350	R2.5	3.5	16°	60	6	42,300
UDCBF 2060-0420	R3	4.2	—	60	6	42,300

※Additional model

Milling Conditions for UDCBF

WORK MATERIAL			CEMENTED CARBIDE ($\geq 87\text{HRA}$) HARD BRITTLE MATERIALS					CEMENTED CARBIDE ($< 87\text{HRA}$)				
Model Number	Radius of Ball Nose (mm)	Length of Cut (mm)	Spindle Speed (min^{-1})	Feed Rate (mm/min)	*Feed Rate 2 (mm/min)	a_p (mm)	a_e (mm)	Spindle Speed (min^{-1})	Feed Rate (mm/min)	*Feed Rate 2 (mm/min)	a_p (mm)	a_e (mm)
2002-0014	R0.1	0.14	30,000	100	10	0.01	0.01	30,000	100	10	0.01	0.01
2003-0021	R0.15	0.21	30,000	125	13	0.015	0.03	30,000	125	13	0.015	0.03
2004-0028	R0.2	0.28	30,000	150	15	0.02	0.08	30,000	150	15	0.02	0.08
2005-0035	R0.25	0.35	30,000	175	18	0.025	0.11	30,000	175	18	0.025	0.11
2006-0042	R0.3	0.42	30,000	200	20	0.03	0.14	30,000	200	20	0.03	0.14
2007-0049	R0.35	0.49	30,000	225	23	0.035	0.17	30,000	225	23	0.035	0.17
2008-0056	R0.4	0.56	30,000	250	25	0.04	0.19	30,000	250	25	0.04	0.19
2009-0063	R0.45	0.63	30,000	275	28	0.045	0.22	30,000	275	28	0.045	0.22
2010-0070	R0.5	0.7	30,000	300	30	0.05	0.25	30,000	300	150	0.35	0.075
2012-0084	R0.6	0.84	27,500	275	36	0.06	0.26	25,000	250	125	0.42	0.09
2015-0105	R0.75	1.05	25,000	250	45	0.075	0.27	19,000	190	95	0.525	0.12
2020-0140	R1	1.4	20,000	200	60	0.1	0.3	12,500	125	60	0.7	0.15
2025-0175	R1.25	1.75	20,000	200	60	0.12	0.3	10,000	100	50	0.8	0.18
2030-0210	R1.5	2.1	20,000	200	100	0.15	0.3	9,000	280	140	0.38	0.15
2040-0280	R2	2.8	18,000	180	90	0.175	0.32	7,200	280	140	0.5	0.2
2050-0350	R2.5	3.5	16,000	160	80	0.225	0.31	6,000	330	170	0.6	0.25
2060-0420	R3	4.2	15,000	150	75	0.3	0.3	5,500	280	140	0.65	0.28

These milling parameters are based on VF-20, VM-40, VC-70, VU-70 (TAS standard) for Cemented Carbide, and Alumina for Hard Brittle Materials. These are for reference only. Tool life may differ depending on the type of Cemented Carbide / Hard Brittle Materials.

For best result, fine parameter adjustments may be required, depending on the materials of Cemented Carbide / Hard Brittle Materials; milling shape and strategy; machine rigidity and spindle capability.

- ※ Feed Rate2: Feed rate of approach and *connection moves.
*Changing from one engagement point to the next.

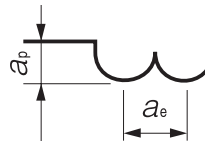

- Note:
- This application requires a high cutting force. A machine with poor rigidity and high vibration is not recommended.
 - Allow sufficient machine and spindle warm-up time for stability and to remove any expansion of the main spindle before running the program.
 - Tool setting length should achieve the least possible overhang.
 - Avoid contact with the coated area of the shank. This will prevent tip vibration and tool jamming in the collet / holder.
 - Run-out and vibration should be checked dynamically at the tool point while mounted in the machine and both should achieve the lowest level possible.
 - Use an inclined or helical approach (Recommended inclination angle: < 5 degree).
 - Decrease both spindle speed and feed rate proportionally.
 - Air blow is highly recommended for longer tool life. Both oil mist and oil coolant are alternatives.
 - Recommend water soluble coolant for Hard Brittle (Non-Metallic) Materials.
 - When milling some work pieces, heavier chips may be created. To evacuate these chips it is important to accurately position the coolant nozzle on the milling part.
 - Remove chips to prevent heat generation and ignition during milling process.
 - Protective gear, such as safety glasses and face guards are required when milling.
 - Chips / dust generated while milling can have adverse effects on the machine parts if they are not properly evacuated. Take steps to assure proper evacuation.

Ø3mm Shank
V Series

UDC-PCD
Series

CBN
Series

Square

Long Neck
Square

Radius

Long Neck
Radius

Taper Neck
Radius

Ball / Long
Shank Ball

Long Neck
Ball

Taper Neck
Ball

Taper

Barrel

Spiral
V Cutter

Drill

Technical Data

Milling Conditions for UDCB

WORK MATERIAL			CEMENTED CARBIDE (≥87HRA)					CEMENTED CARBIDE (<87HRA)					HARD BRITTLE MATERIALS				
Model Number	Radius of Ball Nose (mm)	Length of Cut (mm)	Spindle Speed (min ⁻¹)	Feed Rate (mm/min)	※ Feed Rate 2 (mm/min)	a_p (mm)	a_p (mm)	Spindle Speed (min ⁻¹)	Feed Rate (mm/min)	※ Feed Rate 2 (mm/min)	a_p (mm)	a_p (mm)	Spindle Speed (min ⁻¹)	Feed Rate (mm/min)	※ Feed Rate 2 (mm/min)	a_p (mm)	a_e (mm)
2002-0014	R0.1	0.14	30,000	100	10	0.01	0.01	30,000	100	10	0.01	0.01	30,000	100	10	0.01	0.01
2003-0021	R0.15	0.21	30,000	125	13	0.015	0.03	30,000	125	13	0.015	0.03	30,000	125	13	0.015	0.03
2004-0028	R0.2	0.28	30,000	150	15	0.02	0.08	30,000	150	15	0.02	0.08	30,000	150	15	0.02	0.08
2005-0035	R0.25	0.35	30,000	175	18	0.025	0.11	30,000	175	18	0.025	0.11	30,000	175	18	0.025	0.11
2006-0042	R0.3	0.42	30,000	200	20	0.03	0.14	30,000	200	20	0.03	0.14	30,000	200	20	0.03	0.14
2007-0049	R0.35	0.49	30,000	225	23	0.035	0.17	30,000	225	23	0.035	0.17	30,000	225	23	0.035	0.17
2008-0056	R0.4	0.56	30,000	250	25	0.04	0.19	30,000	250	25	0.04	0.19	30,000	250	25	0.04	0.19
2009-0063	R0.45	0.63	30,000	275	28	0.045	0.22	30,000	275	28	0.045	0.22	30,000	275	28	0.045	0.22
2010-0070	R0.5	0.7	30,000	300	30	0.05	0.25	20,000	400	200	0.35	0.075	30,000	300	30	0.05	0.25
2020-0140	R1	1.4	30,000	300	100	0.1	0.3	16,500	420	210	0.25	0.1	24,000	240	100	0.1	0.3
2030-0210	R1.5	2.1	27,500	275	140	0.125	0.33	11,000	280	140	0.38	0.15	24,000	240	120	0.125	0.33
2040-0280	R2	2.8	24,000	240	120	0.15	0.35	8,250	300	150	0.5	0.2	24,000	240	120	0.15	0.35
2050-0350	R2.5	3.5	22,000	220	110	0.175	0.37	6,600	330	160	0.6	0.25	22,000	220	110	0.175	0.37
2060-0420	R3	4.2	20,000	200	100	0.2	0.4	5,500	280	140	0.65	0.28	20,000	200	100	0.2	0.4

These milling parameters are based on VF-20, VM-40, VC-70, VU-70 (TAS standard) for Cemented Carbide, and Alumina for Hard Brittle Materials. These are for reference only.

Tool life may differ depending on the type of Cemented Carbide / Hard Brittle Materials. For best result, fine parameter adjustments may be required, depending on the materials of Cemented Carbide / Hard Brittle Materials; milling shape and strategy; machine rigidity and spindle capability.

- ※ Feed Rate2: Feed rate of approach and *connection moves.
*Changing from one engagement point to the next.

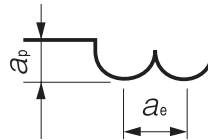

- Note:
- This application requires a high cutting force. A machine with poor rigidity and high vibration is not recommended.
 - Allow sufficient machine and spindle warm-up time for stability and to remove any expansion of the main spindle before running the program.
 - Tool setting length should achieve the least possible overhang.
 - Avoid contact with the coated area of the shank. This will prevent tip vibration and tool jamming in the collet / holder.
 - Run-out and vibration should be checked dynamically at the tool point while mounted in the machine and both should achieve the lowest level possible.
 - Use an inclined or helical approach (Recommended inclination angle: <5 degree).
 - Decrease both spindle speed and feed rate proportionally.
 - Air blow is highly recommended for longer tool life. Both oil mist and oil coolant are alternatives.
 - Recommend water soluble coolant for Hard Brittle (Non-Metallic) Materials.
 - When milling some work pieces, heavier chips may be created. To evacuate these chips it is important to accurately position the coolant nozzle on the milling part.
 - Remove chips to prevent heat generation and ignition during milling process.
 - Protective gear, such as safety glasses and face guards are required when milling.
 - Chips / dust generated while milling can have adverse affects on the machine parts if they are not properly evacuated. Take steps to assure proper evacuation.

Ø3mm Shank V Series
UDC-PCD Series
CBN Series
Square
Long Neck Square
Radius
Long Neck Radius
Taper Neck Radius
Ball / Long Shank Ball
Long Neck Ball
Taper Neck Ball
Taper
Barrel
Spiral V Cutter
Drill
Technical Data

Cemented Carbide Hexalobular milled with UDCB R0.5 x L0.7

VF-20 (92.5HRA)

One R0.5 ball end mill removed 91 mm³ of material



Work size: $\phi 9$ x Depth 2.2 mm

Spindle Speed	30,000 min ⁻¹
Feed Rate	300 mm/min
a_p	0.05 mm
a_e	0.3 mm (Bottom Surface $a_e=0.05$ mm)
Coolant	Oil Mist
Cycle Time	39 min
Material Removal Amount	91.7 mm ³ 2.35 mm ³ /min

Cemented Carbide Pyramid milled with UDCB R0.5 x L0.7

VM-40 (90HRA)

Clean cutter traces! Equal surface condition!

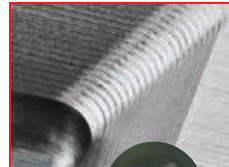

Work size: 6.6 mm x Depth 1.85 mm

Spindle Speed	30,000 min ⁻¹
Feed Rate	300 mm/min
a_p	0.05 mm
a_e	0.25 mm (Bottom Surface $a_e=0.05$ mm)
Coolant	Oil Mist
Cycle Time	24 min
Material Removal Amount	41.3 mm ³ 1.72 mm ³ /min

UDCB Series
VM-40(90HRA)
Pyramid Milling Video



UDCB Series
VF-20(92.5HRA)
Hexalobular Milling Video



Versatile coating!

Alumina / Zirconia Hexalobular milled with UDCB R0.5 x L0.7

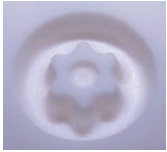
Alumina Al_2O_3 Zirconia ZrO_2 Size : $\phi 9 \times$ Depth 2.2 mm

Tool	UDCB 2010-0070 (R0.5 × 0.7)
Work Material	Alumina Al_2O_3 / Zirconia ZrO_2
Spindle Speed	30,000 min^{-1}
Feed Rate	300 mm/min
a_p	0.05 mm
a_e	0.05 mm
Coolant	Air Blow (Nozzle)
Cycle Time	98 min
Material Removal Amount	88.4 mm^3 0.9 mm^3/min

$\phi 3mm$ Shank
V Series

UDC-PCD
Series

CBN
Series

Square

Square

Long Neck
Square

Radius

Radius

Long Neck
Radius

Taper Neck
Radius

Ball

Ball / Long
Shank Ball

Long Neck
Ball

Taper Neck
Ball

Taper

Taper

Barrel

Barrel

Spiral

Spiral
V Cutter

Drill

Drill

Technical Data

Technical Data



Size R0.3~R1



UDCLBH



Patent pending

NEW

Material Applications (★ Highly Recommended ● Recommended ○ Suggested)

Work Material																	
Carbon Steels S45C S55C	Alloy Steels SK / SCM SUS	Prehardened Steels NAK HPM	Hardened Steels					Cast Iron	Aluminum Alloys	Graphite	Copper	Plastics	Glass Filled Plastics	Titanium Alloys	Heat Resistant Alloys	Cemented Carbide	Hard Brittle (Non-Metallic) Materials
			~50HRC	~55HRC	~60HRC	~65HRC	~70HRC										
												○			★	●	

* Hard Brittle (Non-Metallic) Materials: Ceramics (Alumina, Zirconia, etc.), Glasses and etc.

Features

Long life Long Neck Ball End Mills for milling Cemented Carbide.
 High-level treatment to reduce cutting resistance and minimize damage on cutting edge.
 Wear resistance improved drastically with optimized diamond coating.
 Best for roughing and semi-finishing.

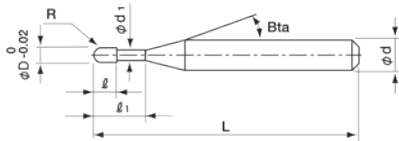
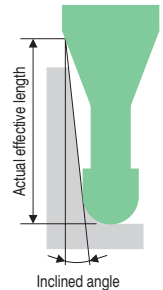

The shank taper angle shown is not an exact value and to avoid contact with the work piece, we recommend the user controls the precise value of this angle. Shank taper angle should not make contact with the work piece.

Label Sample



#001 φD1.989 R0.000/-0.002

Diameter and Ball R accuracy measurements are printed on the label to support High Precision milling.

Total 22 models

Unit (mm)

Model Number	Radius of Ball Nose R	Effective Length ℓ ₁	Length of Cut ℓ	Neck Diameter φ _{d1}	Shank Taper Angle Bta	Overall Length L	Shank Diameter φ _d	Suggested Retail Price ¥	Effective Length by Inclined Angles							
									30°	1°	1°30'	2°	3°			
UDCLBH 2006-0100	R0.3	1	0.42	0.575	16°	50	4	44,740	1.03	1.05	1.08	1.10	1.17			
UDCLBH 2006-0150		1.5							1.54	1.58	1.63	1.67	1.78			
UDCLBH 2006-0200		2							2.06	2.12	2.18	2.24	2.39			
UDCLBH 2006-0300		3							3.09	3.18	3.28	3.38	3.61			
UDCLBH 2007-0100	R0.35	1	0.49	0.675	16°	50	4	44,740	1.02	1.05	1.07	1.10	1.16			
UDCLBH 2008-0200	R0.4	2	0.56	0.775	16°	50	4	44,740	2.05	2.11	2.17	2.23	2.37			
UDCLBH 2008-0300		3							3.09	3.17	3.27	3.37	3.59			
UDCLBH 2008-0400		4							50	4	44,740	4.12	4.24	4.37	4.51	4.82

Unit (mm)

Model Number	Radius of Ball Nose R	Effective Length ℓ_1	Length of Cut ℓ	Neck Diameter ϕ_{d_1}	Shank Taper Angle Bta	Overall Length L	Shank Diameter ϕ_d	Suggested Retail Price ¥	Effective Length by Inclined Angles				
									30°	1°	1°30'	2°	3°
UDCLBH 2010-0150	R0.5	1.5	0.7	0.975	16°	50	4	44,740	1.54	1.57	1.61	1.65	1.73
UDCLBH 2010-0200		2							2.05	2.10	2.16	2.22	2.35
UDCLBH 2010-0250		2.5							2.57	2.63	2.71	2.78	2.96
UDCLBH 2010-0300		3							3.08	3.17	3.26	3.35	3.57
UDCLBH 2010-0400		4							4.11	4.23	4.36	4.49	4.79
UDCLBH 2010-0500		5							5.15	5.30	5.46	5.63	6.02
UDCLBH 2015-0200	R0.75	2	1.05	1.455	16°	50	4	44,740	2.08	2.12	2.17	2.22	2.33
UDCLBH 2015-0400		4							4.14	4.25	4.37	4.50	4.78
UDCLBH 2015-0600		6							6.21	6.38	6.57	6.78	7.23
UDCLBH 2020-0300	R1	3	1.4	1.915	16°	50	4	44,740	3.18	3.25	3.32	3.41	3.59
UDCLBH 2020-0400		4							4.21	4.31	4.42	4.54	4.81
UDCLBH 2020-0600		6							6.27	6.44	6.62	6.82	7.26
UDCLBH 2020-0800		8							8.33	8.57	8.83	9.10	9.71
UDCLBH 2020-1000		10							10.39	10.70	11.03	11.38	12.15

[UDC Milling Tips]

Tool life (= material removal volume) changes depending on the difference in Cemented Carbide material. Recommend to select a material with good workability while considering the required performance (mold life).

Cemented Carbide	TAS Standard	Density g/cm ³	Hardness HRA	Flexural Strength MPa	Compressive Strength MPa	Co Amount* %	Grain Size μm
①	VF-20	14.1	92.5~93	4,500~5,000	—	12	0.5
②	VM-40	14.7	90	3,240	4,700	8.8	2~3
③	VM-40	14.3	89	3,400	—	13.6	—
④	VM-50	14.2	87.5	3,160	4,070	15.1	—
⑤	—	13.1	83	2,660	2,800	28.9	—

*In-house measurement

UDCB R0.5 Comparison of material removal volume (① equals 100%)

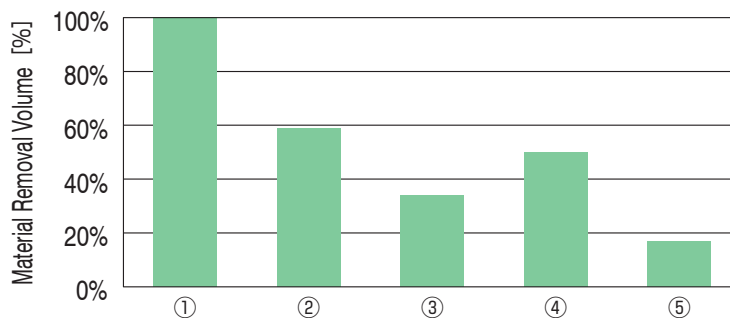

※ The ratio varies depending on the series, tool design, and sizes.

Ø3mm Shank
V Series

UDC-PCD
Series

CBN
Series

Square
Long Neck
Square

Radius
Long Neck
Radius

Taper Neck
Radius

Ball / Long
Shank Ball

Long Neck
Ball

Taper Neck
Ball

Taper

Barrel

Spiral
V Cutter

Drill

Technical Data

Milling Conditions for UDCLBH

WORK MATERIAL			CEMENTED CARBIDE (≥87HRA) / HARD BRITTLE MATERIALS					CEMENTED CARBIDE (<87HRA)					HARD BRITTLE MATERIALS				
Model Number	Radius of Ball Nose (mm)	Effective Length (mm)	Spindle Speed (min ⁻¹)	Feed Rate (mm/min)	※Feed Rate 2 (mm/min)	a _p (mm)	a _e (mm)	Spindle Speed (min ⁻¹)	Feed Rate (mm/min)	※Feed Rate 2 (mm/min)	a _p (mm)	a _e (mm)	Spindle Speed (min ⁻¹)	Feed Rate (mm/min)	※Feed Rate 2 (mm/min)	a _p (mm)	a _e (mm)
2006-0100	R0.3	1	30,000	600	200	0.03	0.14	30,000	450	150	0.17	0.03	30,000	200	20	0.03	0.14
2006-0150		1.5	30,000	600	200	0.03	0.14	30,000	300	100	0.14	0.025	30,000	200	20	0.03	0.14
2006-0200		2	30,000	300	100	0.022	0.11	30,000	220	70	0.11	0.02	30,000	150	15	0.02	0.11
2006-0300		3	30,000	75	10	0.01	0.08	30,000	75	10	0.08	0.01	30,000	75	10	0.01	0.08
2007-0100	R0.35	1	30,000	690	230	0.035	0.17	30,000	525	260	0.18	0.035	30,000	225	23	0.035	0.17
2008-0200	R0.4	2	30,000	750	250	0.04	0.19	27,000	480	240	0.19	0.04	30,000	250	25	0.04	0.19
2008-0300		3	30,000	350	100	0.037	0.17	25,500	300	100	0.17	0.035	30,000	230	23	0.037	0.17
2008-0400		4	26,000	210	70	0.035	0.16	24,000	210	21	0.16	0.035	30,000	210	21	0.035	0.16
2010-0150	R0.5	1.5	30,000	900	300	0.05	0.22	25,000	650	325	0.2	0.05	30,000	300	30	0.05	0.25
2010-0200		2	30,000	900	300	0.05	0.22	24,000	580	290	0.2	0.05	30,000	300	30	0.05	0.25
2010-0250		2.5	30,000	800	300	0.05	0.22	23,500	520	260	0.2	0.05	30,000	300	30	0.05	0.25
2010-0300		3	30,000	600	200	0.05	0.22	23,000	450	220	0.2	0.05	30,000	300	30	0.05	0.25
2010-0400		4	30,000	400	100	0.05	0.22	21,000	320	160	0.2	0.05	30,000	300	30	0.05	0.25
2010-0500		5	27,000	270	100	0.045	0.2	20,000	250	125	0.2	0.05	27,000	270	30	0.045	0.2
2015-0200	R0.75	2	30,000	1,200	400	0.075	0.27	19,000	750	375	0.23	0.07	24,000	400	45	0.075	0.27
2015-0400		4	30,000	900	250	0.075	0.27	18,000	580	290	0.23	0.07	24,000	350	40	0.075	0.27
2015-0600		6	25,000	500	100	0.075	0.27	17,000	400	200	0.23	0.07	24,000	320	36	0.075	0.27
2020-0300	R1	3	30,000	1,500	500	0.1	0.3	16,500	800	400	0.25	0.1	18,000	600	200	0.1	0.3
2020-0400		4	30,000	1,500	500	0.1	0.3	15,750	750	375	0.25	0.1	18,000	500	160	0.1	0.3
2020-0600		6	20,000	850	280	0.1	0.3	15,000	620	310	0.25	0.1	18,000	400	130	0.1	0.3
2020-0800		8	13,000	400	130	0.1	0.3	14,000	520	260	0.25	0.1	18,000	350	120	0.1	0.3
2020-1000		10	10,000	200	60	0.1	0.3	13,000	420	210	0.25	0.1	18,000	300	100	0.1	0.3

These milling parameters are based on VF-20, VM-40, VC-70, VU-70 (TAS standard) for Cemented Carbide, and Alumina for Hard Brittle Materials. These are for reference only.

Tool life may differ depending on the type of Cemented Carbide / Hard Brittle Materials.

For best result, fine parameter adjustments may be required, depending on the materials of Cemented Carbide / Hard Brittle Materials; milling shape and strategy; machine rigidity and spindle capability.

※ Feed Rate2: Feed rate of approach and *connection moves.
*Changing from one engagement point to the next.

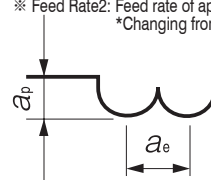

Note:

- This application requires a high cutting force. A machine with poor rigidity and high vibration is not recommended.
- Allow sufficient machine and spindle warm-up time for stability and to remove any expansion of the main spindle before running the program.
- Tool setting length should achieve the least possible overhang.
- Avoid contact with the coated area of the shank.
This will prevent tip vibration and tool jamming in the collet / holder.
- Run-out and vibration should be checked dynamically at the tool point while mounted in the machine and both should achieve the lowest level possible.
- Use an inclined or helical approach (Recommended inclination angle: <5 degree).
- Decrease both spindle speed and feed rate proportionally.
- Air blow is highly recommended for longer tool life. Both oil mist and oil coolant are alternatives.
- Recommend water soluble coolant for Hard Brittle (Non-Metallic) Materials.
- When milling some work pieces, heavier chips may be created. To evacuate these chips it is important to accurately position the coolant nozzle on the milling part.
- Remove chips to prevent heat generation and ignition during milling process.
- Protective gear, such as safety glasses and face guards are required when milling.
- Chips / dust generated while milling can have adverse affects on the machine parts if they are not properly evacuated. Take steps to assure proper evacuation.
- The tool life may shorten due to a large difference between the commanded feed speed and the actual machining speed caused by factors as machining model and machining machine.
- Decrease both feed rate and feed rate 2 proportionally.
- Tool damage may progress rapidly near the end of the tool life.

∅3mm Shank
V Series

UDC-PCD
Series

CBN
Series

Square

Square

Long Neck
Square

Radius

Radius

Long Neck
Radius

Taper Neck
Radius

Ball

Ball / Long
Shank Ball

Long Neck
Ball

Taper Neck
Ball

Taper

Taper

Barrel

Spiral
V Cutter

Drill

Technical Data



Size R0.1~R3



UDCLBF



Patented in Japan, US, China, Korea, Germany, Switzerland, and Liechtenstein

Material Applications (★ Highly Recommended ● Recommended ○ Suggested)

Work Material																	
Carbon Steels S45C S55C	Alloy Steels SK / SCM SUS	Prehardened Steels NAK HPM	Hardened Steels					Cast Iron	Aluminum Alloys	Graphite	Copper	Plastics	Glass Filled Plastics	Titanium Alloys	Heat Resistant Alloys	Cemented Carbide	Hard Brittle (Non-Metallic) Materials
			~50HRC	~55HRC	~60HRC	~65HRC	~70HRC										
												○			★	●	

* Hard Brittle (Non-Metallic) Materials: Ceramics (Alumina, Zirconia, etc.), Glasses and etc.

Features

Long Neck Ball type End Mills for milling Cemented Carbide and Hard Brittle (Non-Metallic) Materials. Upgraded version of UDCLB.

New Diamond coating and flute design increase material removal amount.

Chip pocket designed on tool tip improves the surface finishing quality.

Special cutting edge treatment helps to avoid the edge chipping & level gap.

Recommended to use on semi-roughing & finishing process.

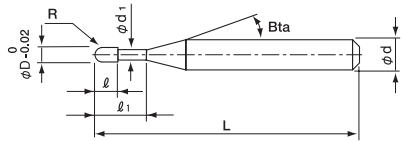
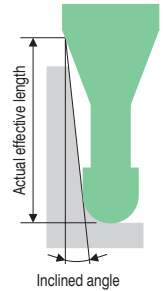

The shank taper angle shown is not an exact value and to avoid contact with the work piece, we recommend the user controls the precise value of this angle. Shank taper angle should not make contact with the work piece.

Label Sample

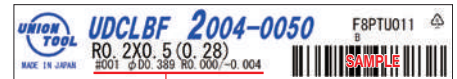

#001 φD0.389 R0.000/-0.004

Diameter and Ball R accuracy measurements are printed on the label to support High Precision milling.

Total 61 models

Unit (mm)

Model Number	Radius of Ball Nose R	Effective Length ℓ ₁	Length of Cut ℓ	Neck Diameter φ _{d1}	Shank Taper Angle B _{ta}	Overall Length L	Shank Diameter φ _d	Suggested Retail Price ¥	Effective Length by Inclined Angles				
									30°	1°	1°30'	2°	3°
UDCLBF 2002-0030	R0.1	0.3	0.14	0.18	16°	50	4	47,500	0.30	0.31	0.32	0.32	0.34
UDCLBF 2002-0050		0.5							0.51	0.52	0.54	0.55	0.59
UDCLBF 2002-0075		0.75							0.77	0.79	0.81	0.84	0.89
UDCLBF 2002-0100		1							1.02	1.05	1.09	1.12	1.20
UDCLBF 2003-0050	R0.15	0.5	0.21	0.28	16°	50	4	47,500	0.51	0.52	0.53	0.55	0.58
UDCLBF 2003-0075		0.75							0.76	0.78	0.81	0.83	0.88
UDCLBF 2003-0100		1							1.02	1.05	1.08	1.11	1.19
UDCLBF 2004-0050	R0.2	0.5	0.28	0.36	16°	50	4	43,300	0.54	0.55	0.56	0.58	0.61
UDCLBF 2004-0100		1							1.06	1.08	1.12	1.15	1.22
UDCLBF 2004-0150		1.5							1.57	1.62	1.67	1.72	1.83
UDCLBF 2004-0200		2							2.09	2.15	2.22	2.29	2.44
UDCLBF 2004-0250		2.5							2.60	2.68	2.77	2.86	3.06

Unit (mm)

Model Number	Radius of Ball Nose R	Effective Length ℓ ₁	Length of Cut ℓ	Neck Diameter φ _{d₁}	Shank Taper Angle Bia	Overall Length L	Shank Diameter φ _d	Suggested Retail Price ¥	Effective Length by Inclined Angles				
									30°	1°	1°30'	2°	3°
UDCLBF 2006-0100	R0.3	1	0.42	0.56	16°	50	4	38,900	1.05	1.08	1.11	1.13	1.20
UDCLBF 2006-0150		1.5							1.57	1.61	1.66	1.70	1.81
UDCLBF 2006-0200		2							2.08	2.14	2.21	2.27	2.42
UDCLBF 2006-0300		3							3.12	3.21	3.31	3.41	3.65
UDCLBF 2006-0400		4							4.15	4.27	4.41	4.55	4.87
UDCLBF 2006-0500		5							5.18	5.34	5.51	5.69	6.09
UDCLBF 2006-0600	6	6.21	6.40	6.61	6.83	7.32							
UDCLBF 2008-0200	R0.4	2	0.56	0.76	16°	50	4	38,900	2.08	2.14	2.20	2.26	2.40
UDCLBF 2008-0300		3							3.11	3.20	3.30	3.40	3.62
UDCLBF 2008-0400		4							4.14	4.27	4.40	4.54	4.85
UDCLBF 2008-0500		5							5.18	5.33	5.50	5.67	6.07
UDCLBF 2008-0600		6							6.21	6.40	6.60	6.81	7.29
UDCLBF 2008-0800		8							8.27	8.53	8.80	9.09	9.74
UDCLBF 2010-0150	R0.5	1.5	0.7	0.96	16°	50	4	38,900	1.56	1.60	1.64	1.68	1.77
UDCLBF 2010-0200		2							2.08	2.13	2.19	2.25	2.38
UDCLBF 2010-0250		2.5							2.59	2.66	2.74	2.81	2.99
UDCLBF 2010-0300		3							3.11	3.20	3.29	3.38	3.60
UDCLBF 2010-0400		4							4.14	4.26	4.39	4.52	4.83
UDCLBF 2010-0600		6							6.20	6.39	6.59	6.80	7.27
UDCLBF 2010-0800	8	8.27	8.52	8.79	9.08	9.72							
UDCLBF 2010-1000	10	10.33	10.65	10.99	11.35	12.17							
UDCLBF 2015-0200	R0.75	2	1.05	1.44	16°	50	4	38,900	2.11	2.15	2.20	2.25	2.37
UDCLBF 2015-0400		4							4.17	4.28	4.40	4.53	4.81
UDCLBF 2015-0600		6							6.23	6.41	6.60	6.81	7.26
UDCLBF 2015-0800		8							8.29	8.54	8.80	9.08	9.71
UDCLBF 2015-1000		10							10.36	10.67	11.00	11.36	12.16
UDCLBF 2015-1200		12							12.42	12.80	13.20	13.64	14.60
UDCLBF 2020-0300	R1	3	1.4	1.9	16°	50	4	38,900	3.20	3.27	3.35	3.43	3.62
UDCLBF 2020-0400		4							4.23	4.34	4.45	4.57	4.84
UDCLBF 2020-0600		6							6.30	6.47	6.65	6.85	7.29
UDCLBF 2020-0800		8							8.36	8.60	8.85	9.13	9.74
UDCLBF 2020-1000		10							10.42	10.73	11.06	11.41	12.19
UDCLBF 2020-1200		12							12.48	12.86	13.26	13.68	14.63
UDCLBF 2020-1400		14							14.55	14.99	15.46	15.96	17.08
UDCLBF 2020-1600		16							16.61	17.12	17.66	18.24	19.53
UDCLBF 2020-1800		18							18.67	19.25	19.86	20.52	No Interference
UDCLBF 2020-2000		20							20.74	21.38	22.06	22.79	No Interference
UDCLBF 2030-0600	R1.5	6	2.1	2.9	16°	60	6	42,800	6.28	6.44	6.60	6.78	7.18
UDCLBF 2030-0800		8							8.34	8.57	8.80	9.06	9.63
UDCLBF 2030-1000		10							10.41	10.70	11.01	11.34	12.08
UDCLBF 2030-1200		12							12.47	12.83	13.21	13.61	14.52
UDCLBF 2030-1400		14							14.53	14.96	15.41	15.89	16.97
UDCLBF 2040-0800	R2	8	2.8	3.9	16°	60	6	42,800	8.33	8.53	8.76	8.99	9.52
UDCLBF 2040-1000		10							10.39	10.66	10.96	11.27	11.97
UDCLBF 2040-1500		15							15.55	15.99	16.46	16.96	18.09
UDCLBF 2050-1000	R2.5	10	3.5	4.8	16°	60	6	42,800	10.55	10.82	11.10	11.40	12.07
UDCLBF 2050-1500		15							15.71	16.14	16.60	17.09	No Interference
UDCLBF 2060-1000	R3	10	4.2	5.7	—	60	6	42,800	No Interference	No Interference	No Interference	No Interference	No Interference
UDCLBF 2060-1500		15							No Interference	No Interference	No Interference	No Interference	No Interference

- Ø3mm Shank V Series
- UDC-PCD Series
- CBN Series
- Square
- Long Neck Square
- Radius
- Long Neck Radius
- Taper Neck Radius
- Ball / Long Shank Ball
- Long Neck Ball
- Taper Neck Ball
- Taper
- Barrel
- Spiral V Cutter
- Drill
- Technical Data

Milling Conditions for UDCLBF

WORK MATERIAL			CEMENTED CARBIDE (≥87HRA) / HARD BRITTLE MATERIALS					CEMENTED CARBIDE (<87HRA)				
Model Number	Radius of Ball Nose (mm)	Effective Length (mm)	Spindle Speed (min ⁻¹)	Feed Rate (mm/min)	**Feed Rate 2 (mm/min)	a _p (mm)	a _e (mm)	Spindle Speed (min ⁻¹)	Feed Rate (mm/min)	**Feed Rate 2 (mm/min)	a _p (mm)	a _e (mm)
2002-0030	R0.1	0.3	30,000	100	10	0.01	0.01	30,000	100	10	0.01	0.01
2002-0050		0.5	30,000	30	10	0.005	0.008	30,000	30	10	0.005	0.008
2002-0075		0.75	30,000	30	10	0.005	0.006	30,000	30	10	0.005	0.006
2002-0100		1	30,000	25	10	0.005	0.005	30,000	25	10	0.005	0.005
2003-0050	R0.15	0.5	30,000	100	10	0.01	0.03	30,000	100	10	0.01	0.03
2003-0075		0.75	30,000	80	10	0.01	0.02	30,000	80	10	0.01	0.02
2003-0100		1	30,000	60	10	0.01	0.02	30,000	60	10	0.01	0.02
2004-0050	R0.2	0.5	30,000	150	15	0.02	0.08	30,000	150	15	0.02	0.08
2004-0100		1	30,000	100	10	0.015	0.07	30,000	100	10	0.015	0.07
2004-0150		1.5	30,000	60	10	0.01	0.06	30,000	60	10	0.01	0.06
2004-0200		2	30,000	30	10	0.008	0.05	30,000	30	10	0.008	0.05
2004-0250		2.5	30,000	15	10	0.006	0.03	30,000	15	10	0.006	0.03
2006-0100		1	30,000	200	20	0.03	0.14	30,000	200	20	0.03	0.14
2006-0150	R0.3	1.5	30,000	200	20	0.03	0.14	30,000	200	20	0.03	0.14
2006-0200		2	30,000	150	15	0.022	0.11	30,000	150	15	0.022	0.11
2006-0300		3	30,000	75	10	0.01	0.08	30,000	75	10	0.01	0.08
2006-0400		4	30,000	75	10	0.01	0.08	30,000	75	10	0.01	0.08
2006-0500		5	30,000	75	10	0.01	0.06	30,000	75	10	0.01	0.06
2006-0600		6	30,000	75	10	0.01	0.03	30,000	75	10	0.01	0.03
2008-0200	R0.4	2	30,000	250	25	0.04	0.19	30,000	250	25	0.04	0.19
2008-0300		3	30,000	230	23	0.037	0.17	30,000	230	23	0.037	0.17
2008-0400		4	30,000	210	21	0.035	0.16	30,000	210	21	0.035	0.16
2008-0500		5	25,000	170	20	0.03	0.12	25,000	170	20	0.03	0.12
2008-0600		6	20,000	130	20	0.025	0.08	20,000	130	20	0.025	0.08
2008-0800	R0.5	8	15,000	100	20	0.015	0.03	15,000	100	20	0.015	0.03
2010-0150		1.5	30,000	300	30	0.05	0.25	30,000	300	150	0.35	0.075
2010-0200		2	30,000	300	30	0.05	0.25	30,000	300	150	0.35	0.075
2010-0250		2.5	30,000	300	30	0.05	0.25	30,000	300	150	0.35	0.075
2010-0300		3	30,000	300	30	0.05	0.25	25,000	250	125	0.35	0.075
2010-0400		4	30,000	300	30	0.05	0.25	25,000	250	125	0.2	0.1
2010-0600	R0.75	6	25,000	250	25	0.04	0.15	25,000	250	125	0.1	0.1
2010-0800		8	20,000	200	25	0.025	0.07	20,000	200	100	0.03	0.08
2010-1000		10	10,000	100	20	0.018	0.03	20,000	200	100	0.02	0.04
2015-0200		2	25,000	250	45	0.075	0.27	18,000	180	90	0.52	0.12
2015-0400		4	25,000	250	45	0.075	0.27	18,000	180	90	0.52	0.12
2015-0600		6	25,000	250	45	0.075	0.27	18,000	180	90	0.4	0.12
2015-0800	R1	8	20,000	160	30	0.075	0.27	18,000	180	90	0.2	0.2
2015-1000		10	20,000	130	30	0.05	0.15	18,000	180	90	0.075	0.25
2015-1200		12	16,000	100	30	0.03	0.08	13,500	135	70	0.05	0.16
2020-0300		3	20,000	200	60	0.1	0.3	12,500	125	60	0.7	0.15
2020-0400		4	20,000	200	60	0.1	0.3	12,500	125	60	0.7	0.15
2020-0600		6	20,000	200	60	0.1	0.3	12,500	125	60	0.7	0.15
2020-0800	R1	8	20,000	200	60	0.1	0.3	12,500	125	60	0.4	0.2
2020-1000		10	20,000	200	60	0.1	0.3	12,500	125	60	0.25	0.25
2020-1200		12	20,000	200	60	0.09	0.25	12,500	125	60	0.1	0.3
2020-1400		14	20,000	200	60	0.07	0.15	12,500	125	60	0.1	0.3
2020-1600		16	13,000	130	36	0.04	0.08	12,500	125	60	0.1	0.3
2020-1800		18	10,000	100	30	0.025	0.05	10,000	100	50	0.04	0.1
2020-2000	20	10,000	100	30	0.02	0.035	10,000	100	50	0.02	0.07	

φ3mm Shank V Series

UDC-PCD Series

CBN Series

Square
Long Neck Square

Radius

Long Neck Radius
Taper Neck Radius

Ball / Long Shank Ball
Long Neck Ball

Taper Neck Ball

Taper

Barrel

Spiral V Cutter

Drill

Technical Data

Milling Conditions for UDCLBF

WORK MATERIAL			CEMENTED CARBIDE (≥87HRA) / HARD BRITTLE MATERIALS					CEMENTED CARBIDE (<87HRA)				
Model Number	Radius of Ball Nose (mm)	Effective Length (mm)	Spindle Speed (min ⁻¹)	Feed Rate (mm/min)	*Feed Rate 2 (mm/min)	a_e (mm)	a_e (mm)	Spindle Speed (min ⁻¹)	Feed Rate (mm/min)	*Feed Rate 2 (mm/min)	a_e (mm)	a_e (mm)
2030-0600	R1.5	6	20,000	200	100	0.15	0.3	9,000	280	140	0.38	0.15
2030-0800		8	20,000	200	100	0.15	0.3	9,000	280	140	0.38	0.15
2030-1000		10	20,000	200	100	0.15	0.3	9,000	280	140	0.38	0.15
2030-1200		12	20,000	200	100	0.15	0.3	9,000	280	140	0.38	0.15
2030-1400		14	20,000	200	100	0.15	0.3	9,000	280	140	0.38	0.15
2040-0800	R2	8	18,000	180	90	0.175	0.32	7,200	280	140	0.5	0.2
2040-1000		10	18,000	180	90	0.175	0.32	7,200	280	140	0.5	0.2
2040-1500		15	18,000	180	90	0.175	0.32	7,200	280	140	0.5	0.2
2050-1000	R2.5	10	16,000	160	80	0.225	0.31	6,000	330	170	0.6	0.25
2050-1500		15	16,000	160	80	0.225	0.31	6,000	330	170	0.6	0.25
2060-1000	R3	10	15,000	150	75	0.3	0.3	5,500	280	140	0.65	0.28
2060-1500		15	15,000	150	75	0.3	0.3	5,500	280	140	0.65	0.28

These milling parameters are based on VF-20, VM-40, VC-70, VU-70 (TAS standard) for Cemented Carbide, and Alumina for Hard Brittle Materials. These are for reference only.

Tool life may differ depending on the type of Cemented Carbide / Hard Brittle Materials.

For best result, fine parameter adjustments may be required, depending on the materials of Cemented Carbide / Hard Brittle Materials; milling shape and strategy; machine rigidity and spindle capability.

※ Feed Rate2: Feed rate of approach and *connection moves.

*Changing from one engagement point to the next.

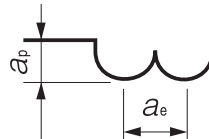

Note:

- This application requires a high cutting force. A machine with poor rigidity and high vibration is not recommended.
- Allow sufficient machine and spindle warm-up time for stability and to remove any expansion of the main spindle before running the program.
- Tool setting length should achieve the least possible overhang.
- Avoid contact with the coated area of the shank. This will prevent tip vibration and tool jamming in the collet / holder.
- Run-out and vibration should be checked dynamically at the tool point while mounted in the machine and both should achieve the lowest level possible.
- Use an inclined or helical approach (Recommended inclination angle: <5 degree).
- Decrease both spindle speed and feed rate proportionally.
- Air blow is highly recommended for longer tool life. Both oil mist and oil coolant are alternatives.
- Recommend water soluble coolant for Hard Brittle (Non-Metallic) Materials.
- When milling some work pieces, heavier chips may be created. To evacuate these chips it is important to accurately position the coolant nozzle on the milling part.
- Remove chips to prevent heat generation and ignition during milling process.
- Protective gear, such as safety glasses and face guards are required when milling.
- Chips / dust generated while milling can have adverse affects on the machine parts if they are not properly evacuated. Take steps to assure proper evacuation.

Ø3mm Shank
V Series

UDC-PCD
Series

CBN
Series

Square

Long Neck
Square

Radius

Long Neck
Radius

Taper Neck
Radius

Ball / Long
Shank Ball

Long Neck
Ball

Taper Neck
Ball

Taper

Barrel

Spiral
V Cutter

Drill

Technical Data



Size R0.1~R3



UDCLB



Material Applications (★ Highly Recommended ● Recommended ○ Suggested)

Work Material																	
Carbon Steels S45C S55C	Alloy Steels SK / SCM SUS	Prehardened Steels NAK HPM	Hardened Steels					Cast Iron	Aluminum Alloys	Graphite	Copper	Plastics	Glass Filled Plastics	Titanium Alloys	Heat Resistant Alloys	Cemented Carbide	Hard Brittle (Non-Metallic) Materials
			~50HRC	~55HRC	~60HRC	~65HRC	~70HRC										
												○ *1			★	● *2	

*1 DCB/DCLB series are highly recommended for Glass Filled Plastic milling.
 *2 Hard Brittle (Non-Metallic) Materials: Ceramics (Alumina, Zirconia, etc.), Glasses and etc.

Total 37 models

Unit (mm)

Model Number	Radius of Ball Nose R	Effective Length l_1	Length of Cut l	Neck Diameter ϕ_d	Shank Taper Angle Bfa	Overall Length L	Shank Diameter ϕ_d	Suggested Retail Price ¥
UDCLB 2002-0030	R0.1	0.3	0.14	0.18	16°	50	4	39,580
UDCLB 2002-0050		0.5				50	4	39,580
UDCLB 2002-0075		0.75				50	4	39,580
UDCLB 2002-0100	R0.2	1	0.28	0.36	16°	50	4	39,580
UDCLB 2004-0050		0.5				50	4	36,080
UDCLB 2004-0100		1				50	4	36,080
UDCLB 2004-0150		1.5				50	4	36,080
UDCLB 2004-0200	R0.3	2	0.42	0.56	16°	50	4	36,080
UDCLB 2006-0100		1				50	4	32,410
UDCLB 2006-0150		1.5				50	4	32,410
UDCLB 2006-0200	R0.4	2	0.56	0.76	16°	50	4	32,410
UDCLB 2006-0300		3				50	4	32,410
UDCLB 2008-0200		2				50	4	32,410
UDCLB 2008-0300		3				50	4	32,410
UDCLB 2008-0400	R0.5	4	0.7	0.96	16°	50	4	32,410
UDCLB 2010-0200		2				50	4	32,410
UDCLB 2010-0250		2.5				50	4	32,410
UDCLB 2010-0300		3				50	4	32,410
UDCLB 2010-0400		4				50	4	32,410
UDCLB 2010-0500	R1	5	1.4	1.9	16°	50	4	32,410
UDCLB 2020-0300		3				50	4	32,410
UDCLB 2020-0400		4				50	4	32,410
UDCLB 2020-0600		6				50	4	32,410
UDCLB 2020-0800	R1.5	8	2.1	2.9	16°	50	4	32,410
UDCLB 2020-1000		10				60	6	35,580
UDCLB 2030-0600		6				60	6	35,580
UDCLB 2030-0800	R2	8	2.8	3.9	16°	60	6	35,580
UDCLB 2030-1000		10				60	6	35,580
UDCLB 2030-1200		12				60	6	35,580
UDCLB 2030-1400		14				60	6	35,580
UDCLB 2040-0800	R2.5	8	3.5	4.8	16°	60	6	35,580
UDCLB 2040-1000		10				60	6	35,580
UDCLB 2040-1500		15				60	6	35,580
UDCLB 2050-1000	R3	10	4.2	5.7	—	60	6	35,580
UDCLB 2050-1500		15				60	6	35,580
UDCLB 2060-1000	R3	10	4.2	5.7	—	60	6	35,580
UDCLB 2060-1500		15				60	6	35,580

Features

Long Neck Ball type End Mills for milling Cemented Carbide and Hard Brittle (Non-Metallic) Materials. Developed to give improved hardness and durability, new Diamond coating also has outstanding adhesion to the cutting tool. By combining the new coating with optimum cutting geometries, the tool "deep cuts" the work piece. Leaves a burr and pit free surface finish on semi-roughing & finishing process.

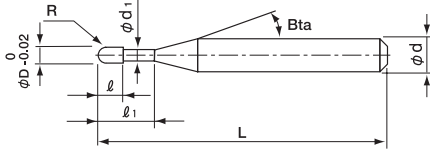
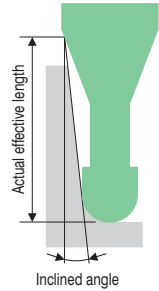

Label Sample

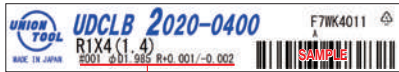

#001 φD1.985 R+0.001/-0.002

Diameter and Ball R accuracy measurements are printed on the label to support High Precision milling.

The shank taper angle shown is not an exact value and to avoid contact with the work piece, we recommend the user controls the precise value of this angle. Shank taper angle should not make contact with the work piece.

Unit (mm)

Model Number	Radius of Ball Nose R	Effective Length ℓ ₁	Effective Length by Inclined Angles				
			30°	1°	1°30'	2°	3°
UDCLB 2002-0030	RO.1	0.3	0.30	0.31	0.32	0.32	0.34
UDCLB 2002-0050		0.5	0.51	0.52	0.54	0.55	0.59
UDCLB 2002-0075		0.75	0.77	0.79	0.81	0.84	0.89
UDCLB 2002-0100	RO.2	1	1.02	1.05	1.09	1.12	1.20
UDCLB 2004-0050		0.5	0.54	0.55	0.56	0.58	0.61
UDCLB 2004-0100		1	1.06	1.08	1.12	1.15	1.22
UDCLB 2004-0150	RO.2	1.5	1.57	1.62	1.67	1.72	1.83
UDCLB 2004-0200		2	2.09	2.15	2.22	2.29	2.44
UDCLB 2006-0100		1	1.05	1.08	1.11	1.13	1.20
UDCLB 2006-0150	RO.3	1.5	1.57	1.61	1.66	1.70	1.81
UDCLB 2006-0200		2	2.08	2.14	2.21	2.27	2.42
UDCLB 2006-0300		3	3.12	3.21	3.31	3.41	3.65
UDCLB 2008-0200	RO.4	2	2.08	2.14	2.20	2.26	2.40
UDCLB 2008-0300		3	3.11	3.20	3.30	3.40	3.62
UDCLB 2008-0400		4	4.14	4.27	4.40	4.54	4.85
UDCLB 2010-0200	RO.5	2	2.08	2.13	2.19	2.25	2.38
UDCLB 2010-0250		2.5	2.59	2.66	2.74	2.81	2.99
UDCLB 2010-0300		3	3.11	3.20	3.29	3.38	3.60
UDCLB 2010-0400	R1	4	4.14	4.26	4.39	4.52	4.83
UDCLB 2010-0500		5	5.17	5.32	5.49	5.66	6.05
UDCLB 2020-0300		3	3.20	3.27	3.35	3.43	3.62
UDCLB 2020-0400	R1	4	4.23	4.34	4.45	4.57	4.84
UDCLB 2020-0600		6	6.30	6.47	6.65	6.85	7.29
UDCLB 2020-0800		8	8.36	8.60	8.85	9.13	9.74
UDCLB 2020-1000	R1.5	10	10.42	10.73	11.06	11.41	12.19
UDCLB 2030-0600		6	6.28	6.44	6.60	6.78	7.18
UDCLB 2030-0800		8	8.34	8.57	8.80	9.06	9.63
UDCLB 2030-1000	R1.5	10	10.41	10.70	11.01	11.34	12.08
UDCLB 2030-1200		12	12.47	12.83	13.21	13.61	14.52
UDCLB 2030-1400		14	14.53	14.96	15.41	15.89	16.97
UDCLB 2040-0800	R2	8	8.33	8.53	8.76	8.99	9.52
UDCLB 2040-1000		10	10.39	10.66	10.96	11.27	11.97
UDCLB 2040-1500		15	15.55	15.99	16.46	16.96	18.09
UDCLB 2050-1000	R2.5	10	10.55	10.82	11.10	11.40	12.07
UDCLB 2050-1500		15	15.71	16.14	16.60	17.09	No Interference
UDCLB 2060-1000	R3	10	No Interference	No Interference	No Interference	No Interference	No Interference
UDCLB 2060-1500		15	No Interference	No Interference	No Interference	No Interference	No Interference

- φ3mm Shank V Series
- UDC-PCD Series
- CBN Series
- Square
- Long Neck Square
- Radius
- Long Neck Radius
- Taper Neck Radius
- Ball / Long Shank Ball
- Long Neck Ball
- Taper Neck Ball
- Taper
- Barrel
- Spiral V Cutter
- Drill
- Technical Data

Milling Conditions for UDCLB

WORK MATERIAL			CEMENTED CARBIDE (≥87HRA)					CEMENTED CARBIDE (<87HRA)					HARD BRITTLE MATERIALS				
Model Number	Radius of Ball Nose (mm)	Effective Length (mm)	Spindle Speed (min ⁻¹)	Feed Rate (mm/min)	※Feed Rate 2 (mm/min)	a _p (mm)	a _e (mm)	Spindle Speed (min ⁻¹)	Feed Rate (mm/min)	※Feed Rate 2 (mm/min)	a _p (mm)	a _e (mm)	Spindle Speed (min ⁻¹)	Feed Rate (mm/min)	※Feed Rate 2 (mm/min)	a _p (mm)	a _e (mm)
2002-0030	R0.1	0.3	30,000	100	10	0.01	0.01	30,000	100	10	0.01	0.01	30,000	100	10	0.01	0.01
2002-0050		0.5	30,000	30	10	0.005	0.008	30,000	30	10	0.005	0.008	30,000	30	10	0.005	0.008
2002-0075		0.75	30,000	30	10	0.005	0.006	30,000	30	10	0.005	0.006	30,000	30	10	0.005	0.006
2002-0100	R0.2	1	30,000	25	10	0.005	0.005	30,000	25	10	0.005	0.005	30,000	25	10	0.005	0.005
2004-0050		0.5	30,000	150	15	0.02	0.08	30,000	150	15	0.02	0.08	30,000	150	15	0.02	0.08
2004-0100		1	30,000	100	10	0.015	0.07	30,000	100	10	0.015	0.07	30,000	100	10	0.015	0.07
2004-0150	R0.3	1.5	30,000	60	10	0.01	0.06	30,000	60	10	0.01	0.06	30,000	60	10	0.01	0.06
2004-0200		2	30,000	30	10	0.008	0.05	30,000	30	10	0.008	0.05	30,000	30	10	0.008	0.05
2006-0100		1	30,000	200	20	0.03	0.14	30,000	200	20	0.03	0.14	30,000	200	20	0.03	0.14
2006-0150	R0.4	1.5	30,000	200	20	0.03	0.14	30,000	200	20	0.03	0.14	30,000	200	20	0.03	0.14
2006-0200		2	30,000	150	15	0.022	0.11	30,000	150	15	0.022	0.11	30,000	150	15	0.022	0.11
2006-0300		3	30,000	75	10	0.01	0.08	30,000	75	10	0.01	0.08	30,000	75	10	0.01	0.08
2008-0200	R0.5	2	30,000	250	25	0.04	0.19	30,000	250	25	0.04	0.19	30,000	250	25	0.04	0.19
2008-0300		3	30,000	230	23	0.037	0.17	30,000	230	23	0.037	0.17	30,000	230	23	0.037	0.17
2008-0400		4	30,000	210	21	0.035	0.16	30,000	210	21	0.035	0.16	30,000	210	21	0.035	0.16
2010-0200	R0.6	2	30,000	300	30	0.05	0.25	20,000	400	200	0.35	0.075	30,000	300	30	0.05	0.25
2010-0250		2.5	30,000	300	30	0.05	0.25	20,000	400	200	0.35	0.075	30,000	300	30	0.05	0.25
2010-0300		3	30,000	300	30	0.05	0.25	20,000	400	200	0.35	0.075	30,000	300	30	0.05	0.25
2010-0400	R0.7	4	30,000	300	30	0.05	0.25	20,000	400	200	0.3	0.07	30,000	300	30	0.05	0.25
2010-0500		5	30,000	300	30	0.05	0.25	20,000	400	200	0.3	0.07	30,000	300	30	0.05	0.25
2020-0300		3	30,000	300	100	0.1	0.3	16,500	420	210	0.25	0.1	24,000	240	100	0.1	0.3
2020-0400	R1	4	30,000	300	100	0.1	0.3	16,500	420	210	0.25	0.1	24,000	240	100	0.1	0.3
2020-0600		6	30,000	300	100	0.1	0.3	16,500	420	210	0.25	0.1	24,000	240	100	0.1	0.3
2020-0800		8	30,000	300	100	0.1	0.3	16,500	420	210	0.25	0.1	24,000	240	100	0.1	0.3
2020-1000	R1.5	10	30,000	300	100	0.1	0.3	16,500	420	210	0.25	0.1	24,000	240	100	0.1	0.3
2030-0600		6	27,500	275	140	0.125	0.33	11,000	280	140	0.38	0.15	24,000	240	120	0.125	0.33
2030-0800		8	27,500	275	140	0.125	0.33	11,000	280	140	0.38	0.15	24,000	240	120	0.125	0.33
2030-1000	R2	10	27,500	275	140	0.125	0.33	11,000	280	140	0.3	0.15	24,000	240	120	0.125	0.33
2030-1200		12	27,500	220	110	0.125	0.33	11,000	280	140	0.3	0.15	24,000	200	100	0.125	0.33
2030-1400		14	27,500	220	110	0.125	0.33	11,000	280	140	0.3	0.15	24,000	200	100	0.125	0.33
2040-0800	R2.5	8	24,000	240	120	0.15	0.35	8,250	300	150	0.5	0.2	24,000	240	120	0.15	0.35
2040-1000		10	24,000	240	120	0.15	0.35	8,250	300	150	0.5	0.2	24,000	240	120	0.15	0.35
2040-1500		15	24,000	240	120	0.15	0.35	8,250	300	150	0.5	0.2	24,000	240	120	0.15	0.35
2050-1000	R3	10	22,000	220	110	0.175	0.37	6,600	330	160	0.6	0.25	22,000	220	110	0.175	0.37
2050-1500		15	22,000	220	110	0.175	0.37	6,600	330	160	0.6	0.25	22,000	220	110	0.175	0.37
2060-1000		10	20,000	200	100	0.2	0.4	5,500	280	140	0.65	0.28	20,000	200	100	0.2	0.4
2060-1500		15	20,000	200	100	0.2	0.4	5,500	280	140	0.65	0.28	20,000	200	100	0.2	0.4

These milling parameters are based on VF-20, VM-40, VC-70, VU-70 (TAS standard) for Cemented Carbide, and Alumina for Hard Brittle Materials. These are for reference only. Tool life may differ depending on the type of Cemented Carbide / Hard Brittle Materials. For best result, fine parameter adjustments may be required, depending on the materials of Cemented Carbide / Hard Brittle Materials; milling shape and strategy; machine rigidity and spindle capability.

※ Feed Rate2: Feed rate of approach and *connection moves.
*Changing from one engagement point to the next.

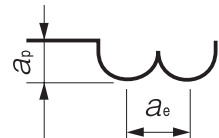

Note:

- This application requires a high cutting force. A machine with poor rigidity and high vibration is not recommended.
- Allow sufficient machine and spindle warm-up time for stability and to remove any expansion of the main spindle before running the program.
- Tool setting length should achieve the least possible overhang.
- Avoid contact with the coated area of the shank. This will prevent tip vibration and tool jamming in the collet / holder.
- Run-out and vibration should be checked dynamically at the tool point while mounted in the machine and both should achieve the lowest level possible.
- Use an inclined or helical approach (Recommended inclination angle: <5 degree).
- Decrease both spindle speed and feed rate proportionally.
- Air blow is highly recommended for longer tool life. Both oil mist and oil coolant are alternatives.
- Recommend water soluble coolant for Hard Brittle (Non-Metallic) Materials.
- When milling some work pieces, heavier chips may be created. To evacuate these chips it is important to accurately position the coolant nozzle on the milling part.
- Remove chips to prevent heat generation and ignition during milling process.
- Protective gear, such as safety glasses and face guards are required when milling.
- Chips / dust generated while milling can have adverse affects on the machine parts if they are not properly evacuated. Take steps to assure proper evacuation.

Cemented Carbide Hexalobular milled with UDCLB R0.5 x EL2

VF-20 (92.5HRA)

Size: $\phi 9$ x Depth 3.5 mm

Tool	UDCLB 2010-0200 (R0.5 x 2 mm)
Spindle Speed	$n=30,000 \text{ min}^{-1}$
Feed Rate	$V_f=300 \text{ mm/min}$
a_p	0.05 mm
a_e	0.30 mm (Bottom Surface 0.05 mm)
Coolant	Air Blow
Cycle Time	64.5 min
Material Removal Amount	164.6 mm^3 $2.57 \text{ mm}^3/\text{min}$

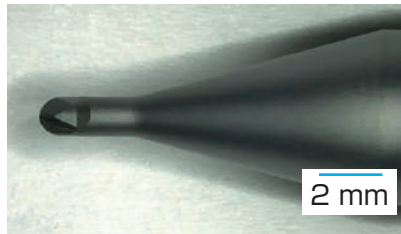
UDCLB
Hexalobular
Milling Video

Cemented Carbide Hexalobular milled with UDCLB R0.5

VF-20 (92.5HRA)

Size:
 $\phi 9$ x Depth 6 mm

Tool	UDCLB 2010-0200 (R0.5 x 2 mm) UDCLB 2010-0500 (R0.5 x 5 mm)
Spindle Speed	$n=30,000 \text{ min}^{-1}$
Feed Rate	$V_f=300 \text{ mm/min}$
Milling Amount	1. R0.5 x 2 Roughing (~Depth 3.5 mm) $a_p=0.05 \text{ mm}$ $a_e=0.3 \text{ mm}$ 2. R0.5 x 5 Roughing (~Depth 6 mm) $a_p=0.05 \text{ mm}$ $a_e=0.25 \text{ mm}$ 3. R0.5 x 5 Finishing $a_p=0.03 \text{ mm}$ $a_e=0.005 \text{ mm}$
Coolant	Air Blow
Cycle Time	156 min
Material Removal Amount	274.4 mm^3



Tool #1 milled depth 3.5 mm.

Tool #2 milled 131.9 mm^3 in 76.5 minutes. $\phi 3$ mm Shank
V SeriesUDC-PCD
SeriesCBN
Series

Square

Square

Long Neck
Square

Radius

Radius

Long Neck
RadiusTaper Neck
RadiusBall / Long
Shank Ball

Ball

Long Neck
BallTaper Neck
Ball

Taper

Taper

Barrel

Spiral
V Cutter

Drill

Technical Data



Size R0.1~R1

UPDLB



Material Applications (★ Highly Recommended ● Recommended ○ Suggested)

Work Material																	
Carbon Steels S45C S55C	Alloy Steels SK / SCM SUS	Prehardened Steels NAK HPM	Hardened Steels					Cast Iron	Aluminum Alloys	Graphite	Copper	Plastics	Glass Filled Plastics	Titanium Alloys	Heat Resistant Alloys	Cemented Carbide	Hard Brittle (Non-Metallic) Materials
			~50HRC	~55HRC	~60HRC	~65HRC	~70HRC										
																★	●

Features

Long Neck Ball type End Mills for finishing of Cemented Carbide and Hard Brittle Materials.
 Provides excellent machined surface quality due to the sharp cutting edge and optimized edge treatment.
 Maintains excellent dimensional accuracy for a long time due to the high contour accuracy of the cutting edge and the excellent wear resistance of diamonds.

Label Sample

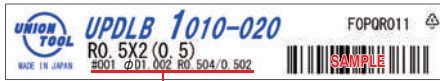

#001 $\phi D1.002$ R0.504/0.502

Diameter and Ball R accuracy measurements are printed on the label to support high precision milling.

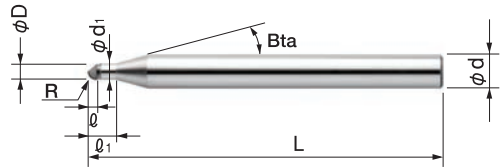

Be sure to confirm the interference between the inclined work piece and the shank part by actual measurement.

Total 5 models

Unit (mm)

Model Number	Radius of Ball Nose R	Effective Length ℓ_1	Length of Cut ℓ	Neck Diameter ϕd_1	Shank Taper Angle Bta	Overall Length L	Shank Diameter ϕd	Suggested Retail Price ¥
UPDLB 1002-004	R0.1	0.4	0.1	0.18	16°	40	4	Open price
UPDLB 1004-008	R0.2	0.8	0.2	0.38	16°	40	4	Open price
UPDLB 1006-010	R0.3	1	0.3	0.58	16°	40	4	Open price
UPDLB 1010-020	R0.5	2	0.5	0.95	16°	40	4	Open price
UPDLB 1020-030	R1	3	1	1.95	16°	40	4	Open price

Milling Conditions for UPDLB

For finishing of bottom surface

WORK MATERIAL			CEMENTED CARBIDE			
Model Number	Radius of Ball Nose (mm)	Effective Length (mm)	Spindle Speed (min ⁻¹)	Feed Rate (mm/min)	a_p (mm)	a_e (mm)
1002-004	R0.1	0.4	40,000	100	0.001	0.001
1004-008	R0.2	0.8	40,000	150	0.001	0.001
1006-010	R0.3	1	40,000	200	0.001	0.001
1010-020	R0.5	2	40,000	400	0.001	0.003
1020-030	R1	3	40,000	600	0.001	0.005

For Profile milling

WORK MATERIAL			CEMENTED CARBIDE			
Model Number	Radius of Ball Nose (mm)	Effective Length (mm)	Spindle Speed (min ⁻¹)	Feed Rate (mm/min)	a_p (mm)	a_e (mm)
1002-004	R0.1	0.4	40,000	100	0.001	0.001
1004-008	R0.2	0.8	40,000	150	0.002	0.001
1006-010	R0.3	1	40,000	200	0.003	0.001
1010-020	R0.5	2	40,000	400	0.005	0.003
1020-030	R1	3	40,000	600	0.01	0.005

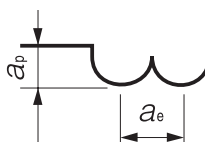

- Note:
- Use a machine with high accuracy for stable cutting.
 - Non-water soluble coolant recommended. Supply as a mist or external coolant. Take fire prevention precautions to avoid fire hazards caused by sparks igniting during machining or tool breakage.
 - Shorten overhang as much as possible.
 - Adjust cutting conditions as necessary as machine spec and other conditions may vary.
 - These cutting parameters show reference value. Adjust the cutting conditions to the desired machined surface finish.

UPDLB Milling Example for Finishing UDCBF / UPDLB R0.5 Cemented Carbide VF-20 (92.5HRA)

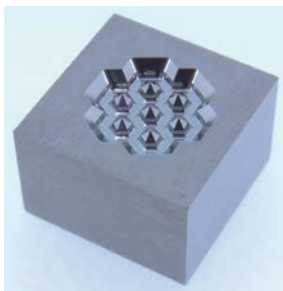

Milling Area : 10.2 × 10.2 × Depth 1.4 mm

Work Size : 20 × 20 × 10 mm

After Finishing

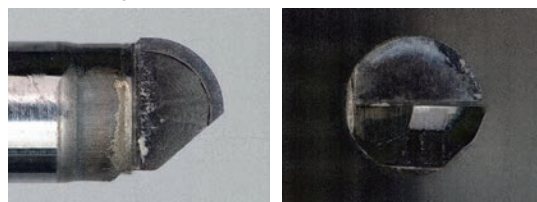

Milling Process	Tool	Spindle Speed (min ⁻¹)	Feed Rate (mm/min)	a_p (mm)	a_e (mm)	Allowance (mm)	Coolant	Cycle Time
Roughing	UDCBF 2010-0070 (R0.5 x L0.7)	30,000	300	0.05	0.25	0.005	Air Blow	30 min
Semi-finishing		30,000	300	0.001 (Cusp Height)	0.06321	0.005		12 min
Finishing	UPDLB 1010-020 (R0.5 x EL2)	40,000	400	0.0035	0.00495	0	Oil Mist	1 h 30 min

Ø3mm Shank
V Series

UDC-PCD
Series

CBN
Series

Square

Square

Long Neck
Square

Radius

Radius

Long Neck
Radius

Taper Neck
Radius

Ball / Long
Shank Ball

Ball

Long Neck
Ball

Taper Neck
Ball

Taper

Taper

Barrel

Spiral
V Cutter

Drill

Technical Data



Size $\phi 0.25 \sim \phi 2$ UDC

UDCLRSF



Patented in Japan, US, China, Korea, Germany, Switzerland, and Liechtenstein

Additional 6 models

Material Applications (★ Highly Recommended ● Recommended ○ Suggested)

Work Material																	
Carbon Steels S45C S55C	Alloy Steels SK / SCM SUS	Prehardened Steels NAK HPM	Hardened Steels					Cast Iron	Aluminum Alloys	Graphite	Copper	Plastics	Glass Filled Plastics	Titanium Alloys	Heat Resistant Alloys	Cemented Carbide	Hard Brittle (Non-Metallic) Materials
			~50HRC	~55HRC	~60HRC	~65HRC	~70HRC										
																★	●

* Hard Brittle (Non-Metallic) Materials: Ceramics (Alumina, Zirconia, etc.), Glasses and etc.

- $\phi 3\text{mm}$ Shank V Series
- UDC-PCD Series
- CBN Series
- Square
- Long Neck Square
- Radius
- Long Neck Radius
- Taper Neck Radius
- Ball / Long Shank Ball
- Long Neck Ball
- Taper Neck Ball
- Taper
- Barrel
- Spiral V Cutter
- Drill
- Technical Data

Total 58 models

Unit (mm)

Model Number	Outside Diameter ϕD	Corner Radius CR	Effective Length l_1	Length of Cut l	Neck Diameter ϕd_1	Shank Taper Angle Bta	Overall Length L	Shank Diameter ϕd	Suggested Retail Price ¥
※ UDCLRSF 20025-003X5	0.25	R0.03	0.5	0.125	0.23	16°	50	4	54,600
※ UDCLRSF 20025-003X8			0.8				50	4	54,600
※ UDCLRSF 20025-005X5		R0.05	0.5				50	4	54,600
※ UDCLRSF 20025-005X8	0.8		50	4	54,600				
UDCLRSF 2003-003006	0.3	R0.03	0.6	0.15	0.28	16°	50	4	54,600
※ UDCLRSF 2003-003009			0.9				50	4	54,600
UDCLRSF 2003-005006		R0.05	0.6				50	4	54,600
※ UDCLRSF 2003-005009	0.9		50	4	54,600				
UDCLRSF 2005-003005	0.5	R0.03	0.5	0.25	0.46	16°	50	4	52,000
UDCLRSF 2005-003010			1				50	4	52,000
UDCLRSF 2005-003015			1.5				50	4	52,000
UDCLRSF 2005-005005		R0.05	0.5				50	4	52,000
UDCLRSF 2005-005010			1				50	4	52,000
UDCLRSF 2005-005015	1.5	50	4	52,000					
UDCLRSF 2008-003008	0.8	R0.03	0.8	0.4	0.76	16°	50	4	46,700
UDCLRSF 2008-003016			1.6				50	4	46,700
UDCLRSF 2008-003024			2.4				50	4	46,700
UDCLRSF 2008-005008		R0.05	0.8				50	4	46,700
UDCLRSF 2008-005016			1.6				50	4	46,700
UDCLRSF 2008-005024			2.4				50	4	46,700
UDCLRSF 2008-010008		R0.1	0.8				50	4	46,700
UDCLRSF 2008-010016			1.6				50	4	46,700
UDCLRSF 2008-010024			2.4				50	4	46,700

※Additional model

Features

Long Neck Radius End Mills for milling Cemented Carbide & Hard Brittle (Non-Metallic) Materials.
 Upgraded version of UDCLRS.
 Improved Diamond coating and optimum cutting geometries will "deep cuts" the material with offering long tool life.
 Special cutting edge treatment helps to avoid the edge chipping & level gap on the work piece.
 Recommended to use on semi-roughing & finishing process.

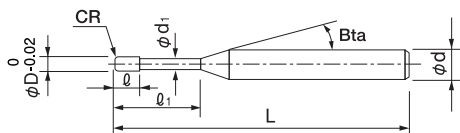
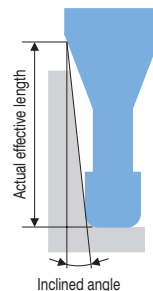

Label Sample



#001 $\phi D1.990 R+0.001/-0.001$

Diameter and Corner R accuracy measurements are printed on the label to support High Precision milling.

The shank taper angle shown is not an exact value and to avoid contact with the workpiece, we recommend the user controls the precise value of this angle. Shank taper angle should not make contact with the work piece.

Unit (mm)

Model Number	Outside Diameter ϕD	Corner Radius CR	Effective Length ℓ_1	Effective Length by Inclined Angles				
				30'	1°	1° 30'	2°	3°
UDCLRSF 2025-003X5	0.25	RO.03	0.5	0.51	0.53	0.54	0.56	0.60
UDCLRSF 2025-003X8			0.8	0.82	0.84	0.87	0.90	0.97
UDCLRSF 2025-005X5		RO.05	0.5	0.51	0.52	0.54	0.56	0.60
UDCLRSF 2025-005X8			0.8	0.82	0.84	0.87	0.90	0.96
UDCLRSF 2003-003006	0.3	RO.03	0.6	0.61	0.63	0.65	0.67	0.72
UDCLRSF 2003-003009			0.9	0.92	0.95	0.98	1.02	1.09
UDCLRSF 2003-005006		RO.05	0.6	0.61	0.63	0.65	0.67	0.72
UDCLRSF 2003-005009			0.9	0.92	0.95	0.98	1.01	1.09
UDCLRSF 2005-003005	0.5	RO.03	0.5	0.55	0.56	0.58	0.60	0.64
UDCLRSF 2005-003010			1	1.06	1.10	1.13	1.17	1.25
UDCLRSF 2005-003015		RO.05	1.5	1.58	1.63	1.68	1.74	1.87
UDCLRSF 2005-005005			0.5	0.55	0.56	0.58	0.60	0.64
UDCLRSF 2005-005010			1	1.06	1.09	1.13	1.17	1.25
UDCLRSF 2005-005015			1.5	1.58	1.63	1.68	1.74	1.86
UDCLRSF 2008-003008	0.8	RO.03	0.8	0.86	0.88	0.91	0.94	1.01
UDCLRSF 2008-003016			1.6	1.68	1.73	1.79	1.85	1.99
UDCLRSF 2008-003024			2.4	2.51	2.59	2.67	2.76	2.97
UDCLRSF 2008-005008		RO.05	0.8	0.85	0.88	0.91	0.94	1.01
UDCLRSF 2008-005016			1.6	1.68	1.73	1.79	1.85	1.98
UDCLRSF 2008-005024			2.4	2.50	2.58	2.67	2.76	2.96
UDCLRSF 2008-010008			RO.1	0.8	0.85	0.88	0.90	0.93
UDCLRSF 2008-010016		1.6		1.68	1.73	1.78	1.84	1.97
UDCLRSF 2008-010024		2.4		2.50	2.58	2.66	2.75	2.95

Next Page →

- φ3mm Shank V Series
- UDC-PCD Series
- CBN Series
- Square
- Long Neck Square
- Radius
- Long Neck Radius
- Taper Neck Radius
- Ball / Long Shank Ball
- Long Neck Ball
- Taper Neck Ball
- Taper
- Barrel
- Spiral V Cutter
- Drill
- Technical Data

Unit (mm)

Model Number	Outside Diameter ϕD	Corner Radius CR	Effective Length ℓ_1	Length of Cut ℓ	Neck Diameter ϕd_1	Shank Taper Angle Bta	Overall Length L	Shank Diameter ϕd	Suggested Retail Price ¥
UDCLRSF 2010-003010	1	RO.03	1	0.5	0.96	16°	50	4	46,700
UDCLRSF 2010-003020			2				50	4	46,700
UDCLRSF 2010-003040			4				50	4	46,700
UDCLRSF 2010-003060			6				50	4	46,700
UDCLRSF 2010-005010		RO.05	1				50	4	46,700
UDCLRSF 2010-005020			2				50	4	46,700
UDCLRSF 2010-005040			4				50	4	46,700
UDCLRSF 2010-005060			6				50	4	46,700
UDCLRSF 2010-010010		RO.1	1				50	4	46,700
UDCLRSF 2010-010020			2				50	4	46,700
UDCLRSF 2010-010040			4				50	4	46,700
UDCLRSF 2010-010060			6				50	4	46,700
UDCLRSF 2015-003015	1.5	RO.03	1.5	0.75	1.44	16°	50	4	46,700
UDCLRSF 2015-003030			3				50	4	46,700
UDCLRSF 2015-005015		RO.05	1.5				50	4	46,700
UDCLRSF 2015-005030			3				50	4	46,700
UDCLRSF 2015-010015		RO.1	1.5				50	4	46,700
UDCLRSF 2015-010030			3				50	4	46,700
UDCLRSF 2015-010040			4				50	4	46,700
UDCLRSF 2015-010060			6				50	4	46,700
UDCLRSF 2020-003020	2	RO.03	2	1	1.9	16°	50	4	46,700
UDCLRSF 2020-003040			4				50	4	46,700
UDCLRSF 2020-003060			6				50	4	46,700
UDCLRSF 2020-003080			8				50	4	46,700
UDCLRSF 2020-003100			10				50	4	46,700
UDCLRSF 2020-005020			RO.05				2	50	4
UDCLRSF 2020-005040		4					50	4	46,700
UDCLRSF 2020-005060		6					50	4	46,700
UDCLRSF 2020-005080		8					50	4	46,700
UDCLRSF 2020-005100		10					50	4	46,700
UDCLRSF 2020-010020		RO.1					2	50	4
UDCLRSF 2020-010040			4				50	4	46,700
UDCLRSF 2020-010060			6				50	4	46,700
UDCLRSF 2020-010080			8				50	4	46,700
UDCLRSF 2020-010100			10				50	4	46,700

φ3mm Shank V Series

UDC-PCD Series

CBN Series

Square
Long Neck Square

Radius
Long Neck Radius

Taper Neck Radius

Ball / Long Shank Ball
Long Neck Ball
Taper Neck Ball

Taper

Barrel

Spiral V Cutter

Drill

Technical Data

Model Number	Outside Diameter ϕD	Corner Radius CR	Effective Length ℓ_1	Effective Length by Inclined Angles					
				30'	1°	1° 30'	2°	3°	
UDCLRSF 2010-003010	1	RO.03	1	1.06	1.10	1.13	1.17	1.25	
UDCLRSF 2010-003020			2	2.09	2.16	2.23	2.31	2.48	
UDCLRSF 2010-003040			4	4.16	4.29	4.43	4.59	4.93	
UDCLRSF 2010-003060			6	6.22	6.42	6.63	6.86	7.37	
UDCLRSF 2010-005010		RO.05	1	1.06	1.09	1.13	1.17	1.25	
UDCLRSF 2010-005020			2	2.09	2.16	2.23	2.31	2.47	
UDCLRSF 2010-005040			4	4.15	4.29	4.43	4.58	4.92	
UDCLRSF 2010-005060			6	6.22	6.42	6.63	6.86	7.37	
UDCLRSF 2010-010010		RO.1	1	1.06	1.09	1.12	1.16	1.24	
UDCLRSF 2010-010020			2	2.09	2.16	2.22	2.30	2.46	
UDCLRSF 2010-010040			4	4.15	4.28	4.43	4.58	4.91	
UDCLRSF 2010-010060			6	6.22	6.41	6.63	6.85	7.36	
UDCLRSF 2015-003015	1.5	RO.03	1.5	1.61	1.66	1.72	1.78	1.91	
UDCLRSF 2015-003030			3	3.16	3.26	3.37	3.49	3.74	
UDCLRSF 2015-005015		RO.05	1.5	1.61	1.66	1.72	1.78	1.90	
UDCLRSF 2015-005030			3	3.16	3.26	3.37	3.48	3.74	
UDCLRSF 2015-010015		RO.1	1.5	1.61	1.66	1.71	1.77	1.89	
UDCLRSF 2015-010030			3	3.16	3.26	3.36	3.48	3.73	
UDCLRSF 2015-010040			4	4.19	4.32	4.46	4.62	4.95	
UDCLRSF 2015-010060			6	6.25	6.45	6.66	6.89	7.40	
UDCLRSF 2020-003020		2	RO.03	2	2.20	2.27	2.35	2.43	2.61
UDCLRSF 2020-003040				4	4.26	4.40	4.55	4.70	5.05
UDCLRSF 2020-003060	6			6.33	6.53	6.75	6.98	7.50	
UDCLRSF 2020-003080	8			8.39	8.66	8.95	9.26	9.95	
UDCLRSF 2020-003100	10			10.45	10.79	11.15	11.54	12.40	
UDCLRSF 2020-005020	RO.05			2	2.20	2.27	2.34	2.42	2.60
UDCLRSF 2020-005040			4	4.26	4.40	4.55	4.70	5.05	
UDCLRSF 2020-005060			6	6.33	6.53	6.75	6.98	7.50	
UDCLRSF 2020-005080			8	8.39	8.66	8.95	9.26	9.94	
UDCLRSF 2020-005100			10	10.45	10.79	11.15	11.53	12.39	
UDCLRSF 2020-010020			RO.1	2	2.20	2.27	2.34	2.42	2.59
UDCLRSF 2020-010040	4			4.26	4.40	4.54	4.69	5.04	
UDCLRSF 2020-010060	6			6.32	6.53	6.74	6.97	7.49	
UDCLRSF 2020-010080	8			8.39	8.66	8.94	9.25	9.93	
UDCLRSF 2020-010100	10			10.45	10.79	11.14	11.53	12.38	

$\phi 3\text{mm}$ Shank
V Series

UDC-PCD
Series

CBN
Series

Square

Square
Long Neck
Square

Radius

Radius
Long Neck
Radius

Taper Neck
Radius

Ball

Ball / Long
Shank Ball
Long Neck
Ball

Taper Neck
Ball

Taper

Taper

Barrel

Spiral
V Cutter

Drill

Technical Data

Milling Conditions for UDCLRSF

WORK MATERIAL	CEMENTED CARBIDE(≥87HRA) / HARD BRITTLE MATERIALS													
	Model Number	Spindle Speed (min ⁻¹)	Z-Level Milling				Flat Milling			Side Milling			Slotting	
Feed Rate (mm/min)			※Feed Rate 2 (mm/min)	a _p (mm)	a _e (mm)	Feed Rate (mm/min)	a _p (mm)	a _e (mm)	Feed Rate (mm/min)	a _p (mm)	a _e (mm)	Feed Rate (mm/min)	a _p (mm)	
20025-003X5	30,000	220	50	0.014	0.2	220	0.014	0.2	100	0.063	0.006	110	0.014	
20025-003X8	30,000	170	50	0.014	0.2	170	0.014	0.2	80	0.032	0.006	90	0.014	
20025-005X5	30,000	220	50	0.018	0.2	220	0.018	0.2	100	0.063	0.006	110	0.018	
20025-005X8	30,000	170	50	0.018	0.2	170	0.018	0.2	80	0.032	0.006	90	0.018	
2003-003006	30,000	220	50	0.015	0.2	220	0.015	0.2	110	0.075	0.006	110	0.015	
2003-003009	30,000	175	50	0.015	0.2	175	0.015	0.2	90	0.038	0.006	90	0.015	
2003-005006	30,000	220	50	0.02	0.2	220	0.02	0.2	110	0.075	0.006	110	0.02	
2003-005009	30,000	175	50	0.02	0.2	175	0.015	0.2	90	0.038	0.006	90	0.02	
2005-003005	30,000	190	90	0.02	0.4	190	0.02	0.4	180	0.25	0.01	190	0.02	
2005-003010	30,000	190	90	0.02	0.4	190	0.02	0.4	180	0.125	0.01	190	0.02	
2005-003015	30,000	140	65	0.015	0.3	140	0.015	0.3	130	0.125	0.007	140	0.015	
2005-005005	30,000	190	125	0.02	0.4	190	0.02	0.4	180	0.25	0.01	190	0.02	
2005-005010	30,000	190	125	0.02	0.4	190	0.02	0.4	180	0.125	0.01	190	0.02	
2005-005015	30,000	140	65	0.015	0.3	140	0.015	0.3	130	0.125	0.007	140	0.015	
2008-003008	30,000	190	90	0.02	0.6	190	0.02	0.6	300	0.4	0.016	190	0.02	
2008-003016	30,000	190	90	0.02	0.6	190	0.02	0.6	300	0.2	0.01	190	0.02	
2008-003024	30,000	175	80	0.018	0.5	175	0.018	0.5	275	0.2	0.007	175	0.018	
2008-005008	30,000	190	150	0.025	0.6	190	0.025	0.6	300	0.4	0.016	190	0.025	
2008-005016	30,000	190	150	0.025	0.6	190	0.025	0.6	300	0.2	0.01	190	0.025	
2008-005024	30,000	175	80	0.023	0.5	175	0.023	0.5	275	0.2	0.007	175	0.023	
2008-010008	30,000	190	150	0.03	0.6	190	0.03	0.6	300	0.4	0.016	190	0.03	
2008-010016	30,000	190	150	0.03	0.6	190	0.03	0.6	300	0.2	0.01	190	0.03	
2008-010024	30,000	175	80	0.028	0.5	175	0.028	0.5	275	0.2	0.007	175	0.028	
2010-003010	30,000	190	90	0.02	0.8	190	0.02	0.8	375	0.5	0.02	190	0.02	
2010-003020	30,000	190	90	0.02	0.8	190	0.02	0.8	375	0.25	0.01	190	0.02	
2010-003040	30,000	190	90	0.016	0.6	190	0.016	0.6	375	0.25	0.005	190	0.016	
2010-003060	25,000	155	75	0.01	0.5	155	0.01	0.5	300	0.25	0.005	155	0.01	
2010-005010	30,000	190	185	0.025	0.8	190	0.025	0.8	375	0.5	0.02	190	0.025	
2010-005020	30,000	190	185	0.025	0.8	190	0.025	0.8	375	0.25	0.01	190	0.025	
2010-005040	30,000	190	185	0.02	0.6	190	0.02	0.6	375	0.25	0.005	190	0.02	
2010-005060	25,000	155	150	0.012	0.5	155	0.012	0.5	300	0.25	0.005	155	0.012	
2010-010010	30,000	190	185	0.03	0.8	190	0.03	0.8	375	0.5	0.02	190	0.03	
2010-010020	30,000	190	185	0.03	0.8	190	0.03	0.8	375	0.25	0.01	190	0.03	
2010-010040	30,000	190	185	0.025	0.6	190	0.025	0.6	375	0.25	0.005	190	0.025	
2010-010060	25,000	155	150	0.015	0.5	155	0.015	0.5	300	0.25	0.005	155	0.015	

φ3mm Shank V Series

UDC-PCD Series

CBN Series

Square
Long Neck Square

Radius

Radius
Long Neck Radius
Taper Neck Radius

Ball / Long Shank Ball
Long Neck Ball
Taper Neck Ball

Taper

Barrel

Spiral V Cutter

Drill

Technical Data

Milling Conditions for UDCLRSF

WORK MATERIAL		CEMENTED CARBIDE (<87HRA)											
Model Number	Spindle Speed (min ⁻¹)	Z-Level Milling				Flat Milling			Side Milling			Slotting	
		Feed Rate (mm/min)	※Feed Rate 2 (mm/min)	a _p (mm)	a _e (mm)	Feed Rate (mm/min)	a _p (mm)	a _e (mm)	Feed Rate (mm/min)	a _p (mm)	a _e (mm)	Feed Rate (mm/min)	a _p (mm)
20025-003X5	24,000	300	50	0.014	0.2	300	0.014	0.2	200	0.063	0.003	300	0.014
20025-003X8	24,000	230	50	0.01	0.2	230	0.01	0.2	150	0.032	0.003	230	0.01
20025-005X5	24,000	300	50	0.018	0.2	300	0.018	0.2	200	0.063	0.003	300	0.018
20025-005X8	24,000	230	50	0.012	0.2	230	0.012	0.2	150	0.032	0.003	230	0.012
2003-003006	21,000	300	50	0.015	0.2	300	0.015	0.2	200	0.075	0.003	300	0.015
2003-003009	21,000	240	50	0.012	0.2	240	0.012	0.2	160	0.038	0.003	240	0.012
2003-005006	21,000	300	50	0.02	0.2	300	0.02	0.2	200	0.075	0.003	300	0.02
2003-005009	21,000	240	50	0.014	0.2	240	0.014	0.2	160	0.038	0.003	240	0.014
2005-003005	16,000	500	160	0.02	0.4	500	0.02	0.4	800	0.25	0.005	500	0.02
2005-003010	16,000	500	160	0.02	0.4	500	0.02	0.4	400	0.125	0.005	500	0.02
2005-003015	16,000	375	120	0.014	0.3	375	0.014	0.3	300	0.125	0.005	375	0.014
2005-005005	16,000	500	160	0.025	0.4	500	0.025	0.4	800	0.25	0.005	500	0.025
2005-005010	16,000	500	160	0.025	0.4	500	0.025	0.4	400	0.125	0.005	500	0.025
2005-005015	16,000	375	120	0.017	0.3	375	0.017	0.3	300	0.125	0.005	375	0.017
2008-003008	13,000	390	130	0.02	0.6	390	0.02	0.6	1,200	0.4	0.008	390	0.02
2008-003016	13,000	390	130	0.02	0.6	390	0.02	0.6	600	0.2	0.008	390	0.02
2008-003024	13,000	350	120	0.014	0.5	350	0.014	0.5	540	0.2	0.006	350	0.014
2008-005008	13,000	390	130	0.025	0.6	390	0.025	0.6	1,200	0.4	0.008	390	0.025
2008-005016	13,000	390	130	0.025	0.6	390	0.025	0.6	600	0.2	0.008	390	0.025
2008-005024	13,000	350	120	0.017	0.5	350	0.017	0.5	540	0.2	0.006	350	0.017
2008-010008	13,000	390	130	0.03	0.6	390	0.03	0.6	1,200	0.4	0.008	390	0.03
2008-010016	13,000	390	130	0.03	0.6	390	0.03	0.6	600	0.2	0.008	390	0.03
2008-010024	13,000	350	120	0.02	0.5	350	0.02	0.5	540	0.2	0.006	350	0.02
2010-003010	12,000	360	120	0.02	0.8	360	0.02	0.8	1,440	0.5	0.01	360	0.02
2010-003020	12,000	360	120	0.02	0.8	360	0.02	0.8	720	0.25	0.01	360	0.02
2010-003040	10,000	300	100	0.012	0.7	300	0.012	0.7	600	0.25	0.008	300	0.012
2010-003060	10,000	300	100	0.008	0.7	300	0.008	0.7	600	0.25	0.006	300	0.008
2010-005010	12,000	360	120	0.025	0.8	360	0.025	0.8	1,440	0.5	0.01	360	0.025
2010-005020	12,000	360	120	0.025	0.8	360	0.025	0.8	720	0.25	0.01	360	0.025
2010-005040	10,000	300	100	0.015	0.7	300	0.015	0.7	600	0.25	0.008	300	0.015
2010-005060	10,000	300	100	0.01	0.7	300	0.01	0.7	600	0.25	0.006	300	0.01
2010-010010	12,000	360	120	0.03	0.8	360	0.03	0.8	1,440	0.5	0.01	360	0.03
2010-010020	12,000	360	120	0.03	0.8	360	0.03	0.8	720	0.25	0.01	360	0.03
2010-010040	10,000	300	100	0.02	0.7	300	0.02	0.7	600	0.25	0.008	300	0.02
2010-010060	10,000	300	100	0.012	0.7	300	0.012	0.7	600	0.25	0.006	300	0.012

Ø3mm Shank
V SeriesUDC-PCD
SeriesCBN
SeriesSquare
Long Neck
Square

Radius

Long Neck
RadiusTaper Neck
RadiusBall / Long
Shank BallLong Neck
BallTaper Neck
Ball

Taper

Barrel

Spiral
V Cutter

Drill

Technical Data

Milling Conditions for UDCLRSF

WORK MATERIAL	CEMENTED CARBIDE($\geq 87\text{HRA}$) / HARD BRITTLE MATERIALS													
	Model Number	Spindle Speed (min ⁻¹)	Z-Level Milling				Flat Milling			Side Milling			Slotting	
			Feed Rate (mm/min)	※Feed Rate 2 (mm/min)	a _p (mm)	a _e (mm)	Feed Rate (mm/min)	a _p (mm)	a _e (mm)	Feed Rate (mm/min)	a _p (mm)	a _e (mm)	Feed Rate (mm/min)	a _p (mm)
2015-003015	25,000	190	90	0.03	1.3	190	0.03	1.3	375	0.75	0.02	190	0.03	
2015-003030	25,000	190	90	0.03	1.3	190	0.03	1.3	375	0.375	0.01	190	0.03	
2015-005015	25,000	190	125	0.04	1.3	190	0.04	1.3	375	0.75	0.02	190	0.04	
2015-005030	25,000	190	125	0.04	1.3	190	0.04	1.3	375	0.375	0.01	190	0.04	
2015-010015	25,000	190	150	0.045	1.3	190	0.045	1.3	375	0.75	0.02	190	0.045	
2015-010030	25,000	190	150	0.045	1.3	190	0.045	1.3	375	0.375	0.01	190	0.045	
2015-010040	25,000	190	150	0.043	1.2	190	0.043	1.2	350	0.375	0.008	190	0.043	
2015-010060	25,000	190	150	0.04	1	190	0.04	1	350	0.375	0.005	190	0.04	
2020-003020	20,000	190	90	0.04	1.8	190	0.04	1.8	375	1	0.02	190	0.04	
2020-003040	20,000	190	90	0.04	1.8	190	0.04	1.8	375	0.5	0.01	190	0.04	
2020-003060	20,000	190	90	0.037	1.7	190	0.037	1.7	325	0.5	0.007	190	0.037	
2020-003080	20,000	190	90	0.03	1.5	190	0.03	1.5	325	0.5	0.005	190	0.03	
2020-003100	20,000	190	90	0.025	1.3	190	0.025	1.3	300	0.5	0.005	190	0.025	
2020-005020	20,000	190	90	0.05	1.8	190	0.05	1.8	375	1	0.02	190	0.05	
2020-005040	20,000	190	90	0.05	1.8	190	0.05	1.8	375	0.5	0.01	190	0.05	
2020-005060	20,000	190	90	0.045	1.7	190	0.045	1.7	325	0.5	0.007	190	0.045	
2020-005080	20,000	190	90	0.04	1.5	190	0.04	1.5	325	0.5	0.005	190	0.04	
2020-005100	20,000	190	90	0.028	1.3	190	0.028	1.3	300	0.5	0.005	190	0.028	
2020-010020	20,000	190	125	0.06	1.8	190	0.06	1.8	375	1	0.02	190	0.06	
2020-010040	20,000	190	125	0.06	1.8	190	0.06	1.8	375	0.5	0.01	190	0.06	
2020-010060	20,000	190	125	0.055	1.7	190	0.055	1.7	325	0.5	0.007	190	0.055	
2020-010080	20,000	190	125	0.045	1.5	190	0.045	1.5	325	0.5	0.005	190	0.045	
2020-010100	20,000	190	125	0.033	1.3	190	0.033	1.3	300	0.5	0.005	190	0.033	

These milling parameters are based on VF-20, VM-40, VC-70, VU-70 (TAS standard) for Cemented Carbide, and Alumina for Hard Brittle Materials. These are for reference only. Tool life may differ depending on the type of Cemented Carbide / Hard Brittle Materials. For best result, fine parameter adjustments may be required, depending on the materials of Cemented Carbide / Hard Brittle Materials; milling shape and strategy; machine rigidity and spindle capability.

※Feed Rate2: Feed rate of approach and *connection moves.
*Changing from one engagement point to the next.

- Ø3mm Shank V Series
- UDC-PCD Series
- CBN Series
- Square
- Long Neck Square
- Radius
- Long Neck Radius
- Taper Neck Radius
- Ball / Long Shank Ball
- Long Neck Ball
- Taper Neck Ball
- Taper
- Barrel
- Spiral V Cutter
- Drill
- Technical Data

Milling Conditions for UDCLRSF

WORK MATERIAL		CEMENTED CARBIDE (<87HRA)												
Model Number	Spindle Speed (min ⁻¹)	Z-Level Milling				Flat Milling			Side Milling			Slotting		
		Feed Rate (mm/min)	※Feed Rate 2 (mm/min)	a _p (mm)	a _e (mm)	Feed Rate (mm/min)	a _p (mm)	a _e (mm)	Feed Rate (mm/min)	a _p (mm)	a _e (mm)	Feed Rate (mm/min)	a _p (mm)	
2015-003015	11,000	330	110	0.03	1.3	330	0.03	1.3	1,440	0.75	0.01	330	0.03	
2015-003030	11,000	330	110	0.03	1.3	330	0.03	1.3	720	0.375	0.01	330	0.03	
2015-005015	11,000	330	110	0.04	1.3	330	0.04	1.3	1,440	0.75	0.01	330	0.04	
2015-005030	11,000	330	110	0.04	1.3	330	0.04	1.3	720	0.375	0.01	330	0.04	
2015-010015	11,000	330	110	0.045	1.3	330	0.045	1.3	1,440	0.75	0.01	330	0.045	
2015-010030	11,000	330	110	0.045	1.3	330	0.045	1.3	720	0.375	0.01	330	0.045	
2015-010040	11,000	330	110	0.045	1.1	330	0.045	1.1	720	0.375	0.01	330	0.045	
2015-010060	11,000	330	110	0.03	1.1	330	0.03	1.1	720	0.375	0.009	330	0.03	
2020-003020	10,000	300	100	0.04	1.8	300	0.04	1.8	1,440	1	0.01	300	0.04	
2020-003040	10,000	300	100	0.04	1.8	300	0.04	1.8	1,440	1	0.01	300	0.04	
2020-003060	10,000	300	100	0.036	1.6	300	0.036	1.6	1,440	0.5	0.01	300	0.036	
2020-003080	10,000	300	100	0.023	1.6	300	0.023	1.6	1,440	0.5	0.009	300	0.023	
2020-003100	10,000	300	100	0.018	1.6	300	0.018	1.6	1,440	0.5	0.009	300	0.018	
2020-005020	10,000	300	100	0.05	1.8	300	0.05	1.8	1,440	1	0.01	300	0.05	
2020-005040	10,000	300	100	0.05	1.8	300	0.05	1.8	1,440	1	0.01	300	0.05	
2020-005060	10,000	300	100	0.045	1.6	300	0.045	1.6	1,440	0.5	0.01	300	0.045	
2020-005080	10,000	300	100	0.028	1.6	300	0.028	1.6	1,440	0.5	0.009	300	0.028	
2020-005100	10,000	300	100	0.02	1.6	300	0.02	1.6	1,440	0.5	0.009	300	0.02	
2020-010020	10,000	300	100	0.06	1.8	300	0.06	1.8	1,440	1	0.01	300	0.06	
2020-010040	10,000	300	100	0.06	1.8	300	0.06	1.8	1,440	1	0.01	300	0.06	
2020-010060	10,000	300	100	0.054	1.6	300	0.054	1.6	1,440	0.5	0.01	300	0.054	
2020-010080	10,000	300	100	0.034	1.6	300	0.034	1.6	1,440	0.5	0.009	300	0.034	
2020-010100	10,000	300	100	0.023	1.6	300	0.023	1.6	1,440	0.5	0.009	300	0.023	

Note:

- This application requires a high cutting force. A machine with poor rigidity and high vibration is not recommended.
- Allow sufficient machine and spindle warm-up time for stability and to remove any expansion of the main spindle before running the program.
- Tool setting length should achieve the least possible overhang.
- Avoid contact with the coated area of the shank. This will prevent tip vibration and tool jamming in the collet / holder.
- Run-out and vibration should be checked dynamically at the tool point while mounted in the machine and both should achieve the lowest level possible.
- Does not require to be slowed down in the approach sequence when slotting and side milling.
- Use an inclined or helical approach when Z-level milling (Recommended inclination angle: <1 degree).
- For flat and side milling, set the axial depth (a_p) and radial depth (a_e) to allow for the uncut material of the corner radius.
- Decrease both spindle speed and feed rate proportionally.
- Air blow is highly recommended for longer tool life. Both oil mist and oil coolant are alternatives.
- Recommend water soluble coolant for Hard Brittle (Non-Metallic) Materials.
- When milling some work pieces, heavier chips may be created. To evacuate these chips it is important to accurately position the coolant nozzle on the milling part.
- Remove chips to prevent heat generation and ignition during milling process.
- Protective gear, such as safety glasses and face guards are required when milling.
- Chips / dust generated while milling can have adverse affects on the machine parts if they are not properly evacuated. Take steps to assure proper evacuation.

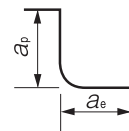

Z-Level / Side / Flat Milling

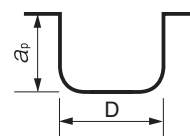
Slotting
D : Outside Diameter (mm)

Ø3mm Shank
V Series
 UDC-PCD
Series
 CBN
Series
 Square
 Long Neck
Square
 Radius
 Long Neck
Radius
 Taper Neck
Radius
 Ball
 Ball / Long
Shank Ball
 Long Neck
Ball
 Taper Neck
Ball
 Taper
 Taper
 Barrel
 Spiral
V Cutter
 Drill
 Technical Data



Size $\phi 0.3 \sim \phi 2$



UDCLRS



Material Applications (★ Highly Recommended ● Recommended ○ Suggested)

Work Material																			
Carbon Steels S45C S55C	Alloy Steels SK / SCM SUS	Prehardened Steels NAK HPM	Hardened Steels					Cast Iron	Aluminum Alloys	Graphite	Copper	Plastics	Glass Filled Plastics	Titanium Alloys	Heat Resistant Alloys	Cemented Carbide	Hard Brittle (Non-Metallic) Materials		
			~50HRC	~55HRC	~60HRC	~65HRC	~70HRC												
																	○ *1	★	● *2

*1 UDCLRSF series are highly recommended for Glass Filled Plastic milling.

*2 Hard Brittle (Non-Metallic) Materials: Ceramics (Alumina, Zirconia, etc.), Glasses and etc.

Total 30 models

Unit (mm)

Model Number	Outside Diameter ϕD	Corner Radius CR	Effective Length l_1	Length of Cut l	Neck Diameter ϕd_1	Shank Taper Angle Bta	Overall Length L	Shank Diameter ϕd	Suggested Retail Price ¥
UDCLRS 2003-003-006	0.3	RO.03	0.6	0.15	0.28	16°	50	4	45,500
UDCLRS 2003-005-006		RO.05	0.6				50	4	45,500
UDCLRS 2005-003-005	0.5	RO.03	0.5	0.25	0.46	16°	50	4	43,300
UDCLRS 2005-003-010			1				50	4	43,300
UDCLRS 2005-005-005		RO.05	0.5				50	4	43,300
UDCLRS 2005-005-010			1				50	4	43,300
UDCLRS 2008-003-008	0.8	RO.03	0.8	0.4	0.76	16°	50	4	38,900
UDCLRS 2008-003-016			1.6				50	4	38,900
UDCLRS 2008-005-008		RO.05	0.8				50	4	38,900
UDCLRS 2008-005-016			1.6				50	4	38,900
UDCLRS 2008-010-008		RO.1	0.8				50	4	38,900
UDCLRS 2008-010-016			1.6				50	4	38,900
UDCLRS 2010-003-010	1	RO.03	1	0.5	0.96	16°	50	4	38,900
UDCLRS 2010-003-020			2				50	4	38,900
UDCLRS 2010-005-010		RO.05	1				50	4	38,900
UDCLRS 2010-005-020			2				50	4	38,900
UDCLRS 2010-010-010		RO.1	1				50	4	38,900
UDCLRS 2010-010-020			2				50	4	38,900
UDCLRS 2015-003-015	1.5	RO.03	1.5	0.75	1.44	16°	50	4	38,900
UDCLRS 2015-003-030			3				50	4	38,900
UDCLRS 2015-005-015		RO.05	1.5				50	4	38,900
UDCLRS 2015-005-030			3				50	4	38,900
UDCLRS 2015-010-015		RO.1	1.5				50	4	38,900
UDCLRS 2015-010-030			3				50	4	38,900
UDCLRS 2020-003-020	2	RO.03	2	1	1.9	16°	50	4	38,900
UDCLRS 2020-003-040			4				50	4	38,900
UDCLRS 2020-005-020		RO.05	2				50	4	38,900
UDCLRS 2020-005-040			4				50	4	38,900
UDCLRS 2020-010-020		RO.1	2				50	4	38,900
UDCLRS 2020-010-040			4				50	4	38,900

Features

UDC offers excellent drilling performance on Cemented Carbide and Hard Brittle (Non-Metallic) Materials. Developed to give improved hardness and durability, the new Diamond coating also has outstanding adhesion to the cutting tool.

By combining the new coating with optimum cutting geometries, the tool "deep cuts" the work piece. Leaves a burr and pit free surface finish whether roughing, semi-finishing or finishing.

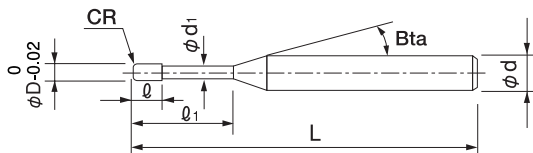

Label Sample



#001 φD1.988 R+0.001/-0.001

Diameter and Corner R accuracy measurements are printed on the label to support High Precision milling.

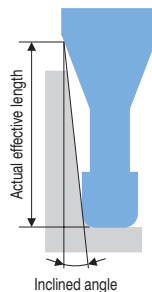

The shank taper angle shown is not an exact value and to avoid contact with the work piece, we recommend the user controls the precise value of this angle. Shank taper angle should not make contact with the work piece.

Unit (mm)

Model Number	Outside Diameter φD	Corner Radius CR	Effective Length ℓ ₁	Effective Length by Inclined Angles				
				30'	1°	1° 30'	2°	3°
UDCLRS 2003-003-006	0.3	RO.03	0.6	0.61	0.63	0.65	0.67	0.72
UDCLRS 2003-005-006		RO.05	0.6	0.61	0.63	0.65	0.67	0.72
UDCLRS 2005-003-005	0.5	RO.03	0.5	0.55	0.56	0.58	0.60	0.64
UDCLRS 2005-003-010			1	1.06	1.10	1.13	1.17	1.25
UDCLRS 2005-005-005		RO.05	0.5	0.55	0.56	0.58	0.60	0.64
UDCLRS 2005-005-010			1	1.06	1.09	1.13	1.17	1.25
UDCLRS 2008-003-008	0.8	RO.03	0.8	0.86	0.88	0.91	0.94	1.01
UDCLRS 2008-003-016			1.6	1.68	1.73	1.79	1.85	1.99
UDCLRS 2008-005-008		RO.05	0.8	0.85	0.88	0.91	0.94	1.01
UDCLRS 2008-005-016			1.6	1.68	1.73	1.79	1.85	1.98
UDCLRS 2008-010-008		RO.1	0.8	0.85	0.88	0.90	0.93	0.99
UDCLRS 2008-010-016			1.6	1.68	1.73	1.78	1.84	1.97
UDCLRS 2010-003-010	1	RO.03	1	1.06	1.10	1.13	1.17	1.25
UDCLRS 2010-003-020			2	2.09	2.16	2.23	2.31	2.48
UDCLRS 2010-005-010		RO.05	1	1.06	1.09	1.13	1.17	1.25
UDCLRS 2010-005-020			2	2.09	2.16	2.23	2.31	2.47
UDCLRS 2010-010-010		RO.1	1	1.06	1.09	1.12	1.16	1.24
UDCLRS 2010-010-020			2	2.09	2.16	2.22	2.30	2.46
UDCLRS 2015-003-015	1.5	RO.03	1.5	1.61	1.66	1.72	1.78	1.91
UDCLRS 2015-003-030			3	3.16	3.26	3.37	3.49	3.74
UDCLRS 2015-005-015		RO.05	1.5	1.61	1.66	1.72	1.78	1.90
UDCLRS 2015-005-030			3	3.16	3.26	3.37	3.48	3.74
UDCLRS 2015-010-015		RO.1	1.5	1.61	1.66	1.71	1.77	1.89
UDCLRS 2015-010-030			3	3.16	3.26	3.36	3.48	3.73
UDCLRS 2020-003-020	2	RO.03	2	2.20	2.27	2.35	2.43	2.61
UDCLRS 2020-003-040			4	4.26	4.40	4.55	4.70	5.05
UDCLRS 2020-005-020		RO.05	2	2.20	2.27	2.34	2.42	2.60
UDCLRS 2020-005-040			4	4.26	4.40	4.55	4.70	5.05
UDCLRS 2020-010-020		RO.1	2	2.20	2.27	2.34	2.42	2.59
UDCLRS 2020-010-040			4	4.26	4.40	4.54	4.69	5.04

φ3mm Shank
V Series

UDC-PCD
Series

CBN
Series

Square
Long Neck
Square

Radius
Long Neck
Radius
Taper Neck
Radius

Ball / Long
Shank Ball
Long Neck
Ball
Taper Neck
Ball

Taper
Taper

Barrel

Spiral
V Cutter

Drill

Technical Data

Milling Conditions for UDCLRS

WORK MATERIAL	CEMENTED CARBIDE(≥87HRA) / HARD BRITTLE MATERIALS													
	Spindle Speed (min ⁻¹)	Z-Level Milling				Flat Milling			Side Milling			Slotting		
		Feed Rate (mm/min)	※Feed Rate 2 (mm/min)	a _p (mm)	a _e (mm)	Feed Rate (mm/min)	a _p (mm)	a _e (mm)	Feed Rate (mm/min)	a _p (mm)	a _e (mm)	Feed Rate (mm/min)	a _p (mm)	
2003-003-006	30,000	220	50	0.01	0.2	220	0.01	0.2	110	0.05	0.001	110	0.01	
2003-005-006	30,000	220	50	0.01	0.2	220	0.01	0.2	110	0.05	0.001	110	0.01	
2005-003-005	30,000	185	90	0.01	0.4	185	0.01	0.4	375	0.25	0.005	375	0.01	
2005-003-010	30,000	185	90	0.01	0.4	185	0.01	0.4	180	0.125	0.005	375	0.01	
2005-005-005	30,000	375	125	0.01	0.4	375	0.01	0.4	375	0.25	0.005	375	0.01	
2005-005-010	30,000	375	125	0.01	0.4	375	0.01	0.4	180	0.125	0.005	375	0.01	
2008-003-008	30,000	185	90	0.01	0.6	185	0.01	0.6	600	0.4	0.008	375	0.01	
2008-003-016	30,000	185	90	0.01	0.6	185	0.01	0.6	300	0.2	0.008	375	0.01	
2008-005-008	30,000	375	150	0.01	0.6	375	0.01	0.6	600	0.4	0.008	375	0.01	
2008-005-016	30,000	375	150	0.01	0.6	375	0.01	0.6	300	0.2	0.008	375	0.01	
2008-010-008	30,000	375	150	0.01	0.6	375	0.01	0.6	600	0.4	0.008	375	0.01	
2008-010-016	30,000	375	150	0.01	0.6	375	0.01	0.6	300	0.2	0.008	375	0.01	
2010-003-010	30,000	185	90	0.01	0.8	185	0.01	0.8	750	0.5	0.01	375	0.01	
2010-003-020	30,000	185	90	0.01	0.8	185	0.01	0.8	375	0.25	0.01	375	0.01	
2010-005-010	30,000	375	185	0.01	0.8	375	0.01	0.8	750	0.5	0.01	375	0.01	
2010-005-020	30,000	375	185	0.01	0.8	375	0.01	0.8	375	0.25	0.01	375	0.01	
2010-010-010	30,000	375	185	0.01	0.8	375	0.01	0.8	750	0.5	0.01	375	0.01	
2010-010-020	30,000	375	185	0.01	0.8	375	0.01	0.8	375	0.25	0.01	375	0.01	
2015-003-015	25,000	185	90	0.01	1.3	185	0.01	1.3	750	0.75	0.01	375	0.015	
2015-003-030	25,000	185	90	0.01	1.3	185	0.01	1.3	375	0.375	0.01	375	0.015	
2015-005-015	25,000	375	125	0.015	1.3	375	0.015	1.3	750	0.75	0.01	375	0.015	
2015-005-030	25,000	375	125	0.015	1.3	375	0.015	1.3	375	0.375	0.01	375	0.015	
2015-010-015	25,000	375	150	0.015	1.3	375	0.015	1.3	750	0.75	0.01	375	0.015	
2015-010-030	25,000	375	150	0.015	1.3	375	0.015	1.3	375	0.375	0.01	375	0.015	
2020-003-020	20,000	185	90	0.01	1.8	185	0.01	1.8	750	1	0.01	375	0.02	
2020-003-040	20,000	185	90	0.01	1.8	185	0.01	1.8	375	0.5	0.01	375	0.02	
2020-005-020	20,000	375	90	0.02	1.8	375	0.02	1.8	750	1	0.01	375	0.02	
2020-005-040	20,000	375	90	0.02	1.8	375	0.02	1.8	375	0.5	0.01	375	0.02	
2020-010-020	20,000	375	125	0.02	1.8	375	0.02	1.8	750	1	0.01	375	0.02	
2020-010-040	20,000	375	125	0.02	1.8	375	0.02	1.8	375	0.5	0.01	375	0.02	

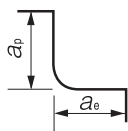

Z-Level / Side / Flat Milling

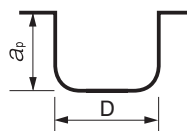

Slotting
D : Outside Diameter (mm)

Milling Conditions for UDCLRS

Model Number	Spindle Speed (min ⁻¹)	CEMENTED CARBIDE (<87HRA)											
		Z-Level Milling				Flat Milling			Side Milling			Slotting	
		Feed Rate (mm/min)	※Feed Rate 2 (mm/min)	a _p (mm)	a _e (mm)	Feed Rate (mm/min)	a _p (mm)	a _e (mm)	Feed Rate (mm/min)	a _p (mm)	a _e (mm)	Feed Rate (mm/min)	a _p (mm)
2003-003-006	21,000	220	50	0.01	0.2	220	0.01	0.2	200	0.075	0.003	200	0.01
2003-005-006	21,000	220	50	0.01	0.2	220	0.01	0.2	200	0.075	0.003	200	0.01
2005-003-005	20,000	275	135	0.02	0.4	275	0.02	0.4	800	0.25	0.005	550	0.02
2005-003-010	20,000	275	135	0.02	0.4	275	0.02	0.4	400	0.125	0.005	550	0.02
2005-005-005	20,000	550	180	0.02	0.4	550	0.02	0.4	800	0.25	0.005	550	0.02
2005-005-010	20,000	550	180	0.02	0.4	550	0.02	0.4	400	0.125	0.005	550	0.02
2008-003-008	19,000	290	145	0.02	0.6	290	0.02	0.6	1,200	0.4	0.008	580	0.025
2008-003-016	19,000	290	145	0.02	0.6	290	0.02	0.6	600	0.2	0.008	580	0.025
2008-005-008	19,000	580	190	0.025	0.6	580	0.025	0.6	1,200	0.4	0.008	580	0.025
2008-005-016	19,000	580	190	0.025	0.6	580	0.025	0.6	600	0.2	0.008	580	0.025
2008-010-008	19,000	580	190	0.025	0.6	580	0.025	0.6	1,200	0.4	0.008	580	0.025
2008-010-016	19,000	580	190	0.025	0.6	580	0.025	0.6	600	0.2	0.008	580	0.025
2010-003-010	18,250	300	150	0.02	0.8	300	0.02	0.8	1,440	0.5	0.01	600	0.025
2010-003-020	18,250	300	150	0.02	0.8	300	0.02	0.8	720	0.25	0.01	600	0.025
2010-005-010	18,250	600	200	0.025	0.8	600	0.025	0.8	1,440	0.5	0.01	600	0.025
2010-005-020	18,250	600	200	0.025	0.8	600	0.025	0.8	720	0.25	0.01	600	0.025
2010-010-010	18,250	600	200	0.025	0.8	600	0.025	0.8	1,440	0.5	0.01	600	0.025
2010-010-020	18,250	600	200	0.025	0.8	600	0.025	0.8	720	0.25	0.01	600	0.025
2015-003-015	16,500	325	160	0.02	1.3	325	0.02	1.3	1,440	0.75	0.01	650	0.035
2015-003-030	16,500	325	160	0.02	1.3	325	0.02	1.3	720	0.375	0.01	650	0.035
2015-005-015	16,500	650	210	0.035	1.3	650	0.035	1.3	1,440	0.75	0.01	650	0.035
2015-005-030	16,500	650	210	0.035	1.3	650	0.035	1.3	720	0.375	0.01	650	0.035
2015-010-015	16,500	650	210	0.035	1.3	650	0.035	1.3	1,440	0.75	0.01	650	0.035
2015-010-030	16,500	650	210	0.035	1.3	650	0.035	1.3	720	0.375	0.01	650	0.035
2020-003-020	15,000	360	180	0.02	1.8	360	0.02	1.8	1,440	1	0.01	720	0.05
2020-003-040	15,000	360	180	0.02	1.8	360	0.02	1.8	1,440	1	0.01	720	0.05
2020-005-020	15,000	720	240	0.05	1.8	720	0.05	1.8	1,440	1	0.01	720	0.05
2020-005-040	15,000	720	240	0.05	1.8	720	0.05	1.8	1,440	1	0.01	720	0.05
2020-010-020	15,000	720	240	0.05	1.8	720	0.05	1.8	1,440	1	0.01	720	0.05
2020-010-040	15,000	720	240	0.05	1.8	720	0.05	1.8	1,440	1	0.01	720	0.05

These milling parameters are based on VF-20, VM-40, VC-70, VU-70 (TAS standard) for Cemented Carbide, and Alumina for Hard Brittle Materials. These are for reference only.

Tool life may differ depending on the type of Cemented Carbide / Hard Brittle Materials.

For best result, fine parameter adjustments may be required, depending on the materials of Cemented Carbide / Hard Brittle Materials; milling shape and strategy; machine rigidity and spindle capability.

※Feed Rate2: Feed rate of approach and *connection moves.
*Changing from one engagement point to the next.

Ø3mm Shank
V Series

UDC-PCD
Series

CBN
Series

Square

Long Neck
Square

Radius

Long Neck
Radius

Taper Neck
Radius

Ball / Long
Shank Ball

Long Neck
Ball

Taper Neck
Ball

Taper

Barrel

Spiral
V Cutter

Drill

Technical Data

Note:

- This application requires a high cutting force. A machine with poor rigidity and high vibration is not recommended.
- Allow sufficient machine and spindle warm-up time for stability and to remove any expansion of the main spindle before running the program.
- Tool setting length should achieve the least possible overhang.
- Avoid contact with the coated area of the shank. This will prevent tip vibration and tool jamming in the collet / holder.
- Run-out and vibration should be checked dynamically at the tool point while mounted in the machine and both should achieve the lowest level possible.
- Does not require to be slowed down in the approach sequence when slotting and side milling.
- Use an inclined or helical approach when Z-level milling (Recommended inclination angle: <1 degree).
- For flat and side milling, set the axial depth (ap) and radial depth (ae) to allow for the uncut material of the corner radius.
- Decrease both spindle speed and feed rate proportionally.
- Air blow is highly recommended for longer tool life. Both oil mist and oil coolant are alternatives.
- Recommend water soluble coolant for Hard Brittle (Non-Metallic) Materials.
- When milling some work pieces, heavier chips may be created. To evacuate these chips it is important to accurately position the coolant nozzle on the milling part.
- Remove chips to prevent heat generation and ignition during milling process.
- Protective gear, such as safety glasses and face guards are required when milling.
- Chips / dust generated while milling can have adverse affects on the machine parts if they are not properly evacuated. Take steps to assure proper evacuation.

<p>Ø3mm Shank V Series</p>	
<p>UDC-PCD Series</p>	
<p>CBN Series</p>	
<p>Square</p>	Square
<p>Long Neck Square</p>	
<p>Radius</p>	Radius
<p>Long Neck Radius</p>	
<p>Taper Neck Radius</p>	
<p>Ball / Long Shank Ball</p>	Ball
<p>Long Neck Ball</p>	
<p>Taper Neck Ball</p>	
<p>Taper</p>	Taper
<p>Barrel</p>	
<p>Spiral V Cutter</p>	
<p>Drill</p>	
<p>Technical Data</p>	

Cemented Carbide Milling Example UDCLRS 2020-005-020 ($\phi 2 \times CR0.05 \times 2$) VM-40 (90HRA)

Work sample after finishing

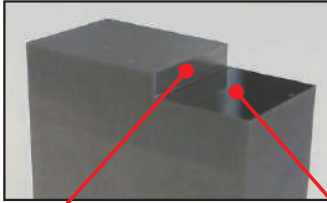

Ra : $0.069 \mu\text{m}$
Rz : $0.535 \mu\text{m}$
Cut-off length : 0.25 mm

Ra : $0.010 \mu\text{m}$ (10 nm)
Rz : $0.078 \mu\text{m}$ (78 nm)
Cut-off length: 0.08 mm

Bottom Surface Quality



Mirror surface finish
with zero pits!

After Finishing

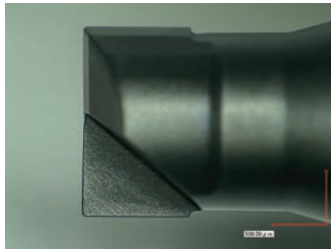
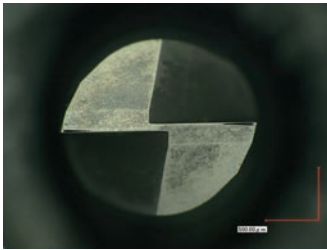
UDCLRS
Side Milling Video

Milling Conditions	Roughing Parameter	Finishing Parameter
Spindle Speed	20,000 min ⁻¹	20,000 min ⁻¹
XY Feed Rate	750 mm/min	100 mm/min
a_p	0.9 mm	0.01 mm Bottom Surface 0.9 mm Side
a_e	0.01 mm	0.01 mm
Coolant	Air Blow	Oil Mist
Milling Size	$10 \times 8 \times 1.8 \text{ mm}$	0.01 mm Bottom Surface 0.05 mm Side (0.01 mm \times 5 times)
Milling Distance	16 m	—
Material Removal Volume	144 mm ³	—

* One End Mill was used for both the roughing and finishing processes.

Overhang : 15 mm

$\phi 3\text{mm}$ Shank
V Series

UDC-PCD
Series

CBN
Series

Square

Long Neck
Square

Radius

Long Neck
Radius

Taper Neck
Radius

Ball / Long
Shank Ball

Long Neck
Ball

Taper Neck
Ball

Taper

Barrel

Spiral
V Cutter

Drill

Technical Data



Size $\phi 2 \sim \phi 6$



UDCRRS



NEW

Material Applications (★ Highly Recommended ● Recommended ○ Suggested)

Work Material																		
Carbon Steels S45C S55C	Alloy Steels SK / SCM SUS	Prehardened Steels NAK HPM	Hardened Steels					Cast Iron	Aluminum Alloys	Graphite	Copper	Plastics	Glass Filled Plastics	Titanium Alloys	Heat Resistant Alloys	Cemented Carbide	Hard Brittle (Non-Metallic) Materials	
			~50HRC	~55HRC	~60HRC	~65HRC	~70HRC											
																○	★	●

* Hard Brittle (Non-Metallic) Materials: Ceramics (Alumina, Zirconia, etc.), Glass, etc.

Total 4 models

Unit (mm)

Model Number	Outside Diameter ϕD	Corner Radius CR	Effective Length ℓ_1	Length of Cut ℓ	Neck Diameter ϕd_1	Shank Taper Angle Bta	Overall Length L	Shank Diameter ϕd	Number of Flutes	Suggested Retail Price ¥
UDCRRS 6020-020-050	2	RO.2	5	1.6	1.77	16°	50	4	6	42,800
UDCRRS 6030-020-075	3	RO.2	7.5	2.4	2.77	16°	60	6	6	45,960
UDCRRS 6040-020-100	4	RO.2	10	3.2	3.77	16°	60	6	6	45,960
UDCRRS 10060-020150	6	RO.2	15	4.8	5.77	16°	60	6	10	48,370

High Efficiency

6 flutes, 10 flutes with a 40° helix angle help to reduce cutting load allowing for deep milling on axial depth.

$\phi 2 \sim \phi 4$
6 Flutes



$\phi 6$
10 Flutes



Milling amount compared with 2 Flutes ($\phi 2 \times EL 6$)

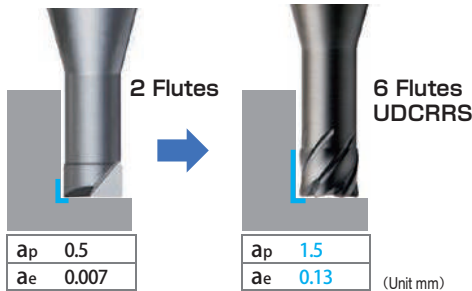

Compared to a tool with 2 flutes, the a_p is 3 times and the a_e 18 times higher in comparison. This shows a significant efficiency improvement.

Cutting material removal volume for each size

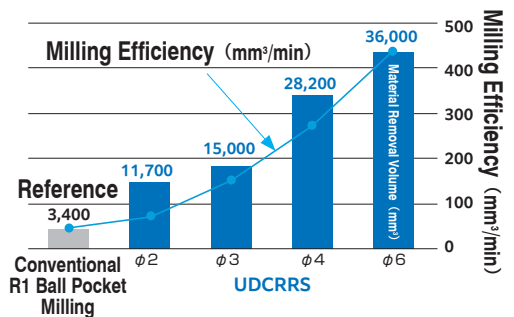

Milling efficiency and material removal volume exceeds the conventional tool.

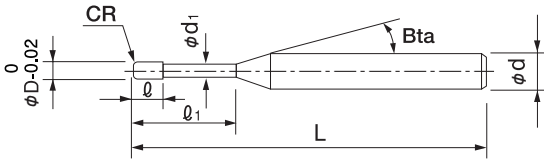

The shank taper angle shown is not an exact value and to avoid contact with the work piece, we recommend the user controls the precise value of this angle. Shank taper angle should not make contact with the work piece.

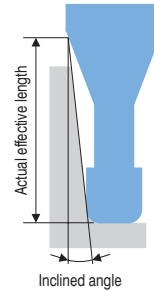

Unit (mm)

Model Number	Outside Diameter φD	Corner Radius CR	Effective Length ℓ _i	Effective Length by Inclined Angles				
				30'	1°	1° 30'	2°	3°
UDCRRS 6020-020-050	2	RO.2	5	5.52	5.70	5.88	6.08	6.52
UDCRRS 6030-020-075	3	RO.2	7.5	8.10	8.36	8.63	8.92	9.58
UDCRRS 6040-020-100	4	RO.2	10	10.68	11.02	11.38	11.77	12.64
UDCRRS 10060-020150	6	RO.2	15	No Interference	No Interference	No Interference	No Interference	No Interference

Roughing Conditions for UDCRRS

WORK MATERIAL		CEMENTED CARBIDE (≥87HRA) / HARD BRITTLE MATERIALS							CEMENTED CARBIDE (<87HRA)						
Model Number	Outside Diameter (mm)	Spindle Speed (min ⁻¹)	Flat milling			Side milling			Spindle Speed (min ⁻¹)	Flat milling			Side milling		
			*Feed Rate (mm/min)	a _p (mm)	a _e (mm)	*Feed Rate (mm/min)	a _p (mm)	a _e (mm)		*Feed Rate (mm/min)	a _p (mm)	a _e (mm)	*Feed Rate (mm/min)	a _p (mm)	a _e (mm)
6020-020-050	2	20,000	375	0.1	0.8	375	1.5	0.13	10,000	375	0.1	0.8	1,440	1.5	0.02
6030-020-075	3	17,500	375	0.1	1.2	375	2.2	0.19	6,700	375	0.1	1.2	1,610	2.2	0.02
6040-020-100	4	15,000	375	0.1	1.6	375	3	0.25	5,000	375	0.1	1.6	1,780	3	0.02
10060-020150	6	10,000	375	0.2	1	375	4	0.3	3,300	375	0.2	1	2,000	4	0.02

*Set the feed rate of approach and connecting points (changing from one engagement point to the next) to 100 mm/min.

Roughing with UDCRRS



Finishing with UDC 2 Flutes

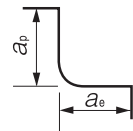

*UDCRRS is designed for roughing, use other UDC 2 flutes when finishing.

These milling parameters are based on VF-20, VM-40, VC-70, VU-70 (TAS standard) for Cemented Carbide, and Alumina for Hard Brittle Materials. These are for reference only.

Tool life may differ depending on the type of Cemented Carbide / Hard Brittle Materials.

For best result, fine parameter adjustments may be required, depending on the materials of Cemented Carbide / Hard Brittle Materials; milling shape and strategy; machine rigidity and spindle capability.

6 Flutes

10 Flutes

φ3mm Shank V Series

UDC-PCD Series

CBN Series

Square

Square

Long Neck Square

Radius

Radius

Long Neck Radius

Taper Neck Radius

Ball

Ball / Long Shank Ball

Ball

Long Neck Ball

Taper Neck Ball

Taper

Taper

Barrel

Barrel

Spiral V Cutter

Spiral V Cutter

Drill

Drill

Technical Data

Technical Data

The best way to use UDCRRS for high efficiency and long tool life

point1 Circular arc milling

Circular arc milling is recommended so the returning point is not an acute angle. This reduces cutting load on the peripheral cutting edge.

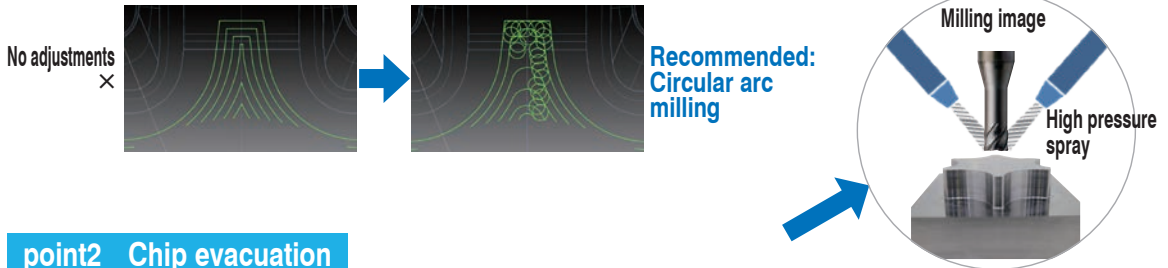

point2 Chip evacuation

Air blow coolant is recommended. Recommended **spraying from multiple directions at high pressure** as much as possible.

Cemented Carbide Milling example of punching die
UDCRRS $\phi 4 \times CRO.2 \times EL10$

VM-40 (90HRA)

Spindle Speed	15,000 min ⁻¹
Feed Rate	375 mm/min
a_p	3 mm
a_e	0.25 mm
Coolant	Air Blow
Cycle Time	93 min

Depth 9 mm
 a_p 3 mm \times 3 times

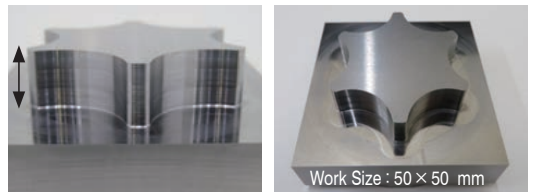

Tool after milling



Milling volume 15,953 mm³ with a single tool in 93 min.
Tool damage is limited and continuous cutting is possible.

ø3mm Shank
V Series

UDC-PCD
Series

CBN
Series

Square

Long Neck
Square

Radius

Long Neck
Radius

Taper Neck
Radius

Ball / Long
Shank Ball

Long Neck
Ball

Taper Neck
Ball

Taper

Barrel

Spiral
V Cutter

Drill

Technical Data

- Note:
- This application requires a high cutting force. A machine with poor rigidity and high vibration is not recommended.
 - Allow sufficient machine and spindle warm-up time for stability and to remove any expansion of the main spindle before running the program.
 - Tool setting length should achieve the least possible overhang.
 - Avoid contact with the coated area of the shank. This will prevent tip vibration and tool jamming in the collet / holder.
 - Run-out and vibration should be checked dynamically at the tool point while mounted in the machine and both should achieve the lowest level possible.
 - Decrease both spindle speed and feed rate proportionally.
 - Air blow is highly recommended for longer tool life. Both oil mist and oil coolant are alternatives.
 - Recommend water soluble coolant for Hard Brittle (Non-Metallic) Materials.
 - When milling some work pieces, heavier chips may be created. To evacuate these chips it is important to accurately position the coolant nozzle on the milling part.
 - Remove chips to prevent heat generation and ignition during milling process.
 - Protective gear, such as safety glasses and face guards are required when milling.
 - Chips / dust generated while milling can have adverse affects on the machine parts if they are not properly evacuated. Take steps to assure proper evacuation.
 - The tool life may shorten due to a large difference between the commanded feed speed and the actual machining speed caused by factors as machining model and machining machine.
 - Tool damage may progress rapidly near the end of the tool life.

6 Flutes

10 Flutes

Ø3mm Shank
V Series

UDC-PCD
Series

CBN
Series

Square

Square

Long Neck
Square

Radius

Radius

Long Neck
Radius

Taper Neck
Radius

Ball

Ball / Long
Shank Ball

Long Neck
Ball

Taper Neck
Ball

Taper

Taper

Barrel

Spiral
V Cutter

Drill

Technical Data



Size $\phi 0.2 \sim \phi 2$

UPDLRS



Material Applications (★ Highly Recommended ● Recommended ○ Suggested)

Work Material																	
Carbon Steels	Alloy Steels	Prehardened Steels	Hardened Steels					Cast Iron	Aluminum Alloys	Graphite	Copper	Plastics	Glass Filled Plastics	Titanium Alloys	Heat Resistant Alloys	Cemented Carbide	Hard Brittle (Non-Metallic) Materials
			~50HRC	~55HRC	~60HRC	~65HRC	~70HRC										
S45C S55C	SK / SCM SUS	NAK HPM														★	●

Features

Long Neck Radius End Mills for finishing of Cemented Carbide and Hard Brittle Materials.
 Provides excellent machined surface quality due to the sharp cutting edge and optimized edge treatment.
 Maintains excellent dimensional accuracy for a long time due to the high contour accuracy of the cutting edge and the excellent wear resistance of diamonds.

Label Sample



#001 $\phi D 0.499$ R0.049/0.048

Diameter and Ball R accuracy measurements are printed on the label to support high precision milling.

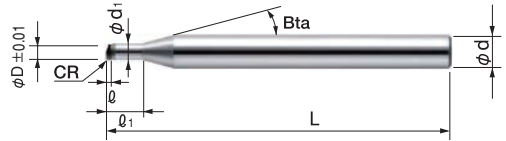

Be sure to confirm the interference between the inclined work piece and the shank part by actual measurement.

Total 12 models

Unit (mm)

Model Number	Outside Diameter ϕD	Corner Radius CR	Effective Length ℓ_1	Length of Cut ℓ	Neck Diameter ϕd_1	Shank Taper Angle Bta	Overall Length L	Shank Diameter ϕd	Suggested Retail Price ¥
UPDLRS 1002-002-006	0.2	R0.02	0.6	0.1	0.175	16°	40	4	Open price
UPDLRS 1002-005-006		R0.05							Open price
UPDLRS 1003-002-010	0.3	R0.02	1	0.15	0.27	16°	40	4	Open price
UPDLRS 1003-005-010		R0.05							Open price
UPDLRS 1005-005-015	0.5	R0.05	1.5	0.25	0.47	16°	40	4	Open price
UPDLRS 1005-010-015		R0.1							Open price
UPDLRS 1010-005-030	1	R0.05	3	0.55	0.95	16°	40	4	Open price
UPDLRS 1010-010-030		R0.1							Open price
UPDLRS 1010-020-030		R0.2							Open price
UPDLRS 1020-005-040	2	R0.05	4	0.55	1.95	16°	40	4	Open price
UPDLRS 1020-010-040		R0.1							Open price
UPDLRS 1020-020-040		R0.2							Open price

Milling Conditions for UPDLRS

WORK MATERIAL			CEMENTED CARBIDE			
Model Number	Outside Diameter (mm)	Effective Length (mm)	Spindle Speed (min ⁻¹)	Feed Rate (mm/min)	a_p (mm)	a_e (mm)
1002-002-006	0.2	0.6	40,000	100	0.001	0.001
1002-005-006			40,000	100	0.001	0.001
1003-002-010	0.3	1	40,000	150	0.002	0.001
1003-005-010			40,000	150	0.002	0.001
1005-005-015	0.5	1.5	40,000	200	0.003	0.001
1005-010-015			40,000	200	0.003	0.001
1010-005-030	1	3	40,000	400	0.005	0.003
1010-010-030			40,000	400	0.005	0.003
1010-020-030			40,000	400	0.005	0.003
1020-005-040	2	4	40,000	600	0.01	0.005
1020-010-040			40,000	600	0.01	0.005
1020-020-040			40,000	600	0.01	0.005

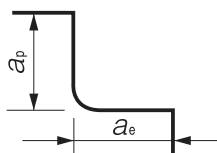

- Note:
- Use a machine with high accuracy for stable cutting.
 - Non-water soluble coolant recommended. Supply as a mist or external coolant. Take fire prevention precautions to avoid fire hazards caused by sparks igniting during machining or tool breakage.
 - Shorten overhang as much as possible.
 - Adjust cutting conditions as necessary as machine spec and other conditions may vary.
 - These cutting parameters show reference value. Adjust the cutting conditions to the desired machined surface finish.

Cemented Carbide UPDLRS Milling Example for Finishing UDCLRSF / UPDLRS $\phi 2$ VF-20 (92.5HRA)

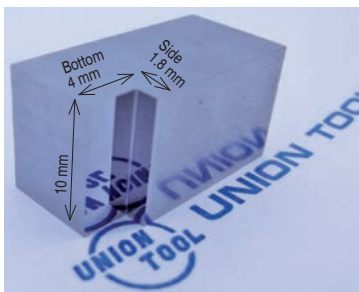

Milling Area : $4 \times 10 \times$ Depth 1.8 mm

Work Size : $10 \times 10 \times 20$ mm

After Finishing

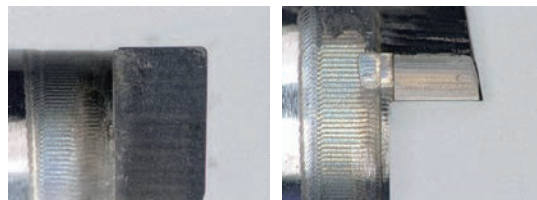

Milling Process	Tool	Spindle Speed (min ⁻¹)	Feed Rate (mm/min)	a_p (mm)	a_e (mm)	Stock (mm)	Coolant	Cycle Time
Roughing	UDCLRSF 2020-005020 ($\phi 2 \times CR0.05 \times EL2$)	20,000	400	0.9×2 Times	0.01	0.005	Air Blow	54 min
Finishing (Bottom)	UPDLRS 1020-005-040 ($\phi 2 \times CR0.05 \times EL4$)	40,000	600	0.01	0.005	0		45 min
Finishing (Side)		40,000	400	0.002	0.01	0		52 min

$\phi 3$ mm Shank
V Series

UDC-PCD
Series

CBN
Series

Square
Square

Long Neck
Square

Radius

Long Neck
Radius

Taper Neck
Radius

Ball / Long
Shank Ball

Long Neck
Ball

Taper Neck
Ball

Taper

Barrel

Spiral
V Cutter

Drill

Technical Data



Size $\phi 0.3 \sim \phi 7$



UDCMX



Material Applications (★ Highly Recommended ● Recommended ○ Suggested)

Work Material																		
Carbon Steels S45C S55C	Alloy Steels SK / SCM SUS	Prehardened Steels NAK HPM	Hardened Steels					Cast Iron	Aluminum Alloys	Graphite	Copper	Plastics	Glass Filled Plastics	Titanium Alloys	Heat Resistant Alloys	Cemented Carbide	Hard Brittle (Non-Metallic) Materials	
			~50HRC	~55HRC	~60HRC	~65HRC	~70HRC											
																●	★	● *

* Hard Brittle (Non-Metallic) Materials: Ceramics (Alumina, Zirconia, etc.), Glasses and etc.

Features

UDC offers excellent drilling performance on Cemented Carbide and Hard Brittle (Non-Metallic) Materials. By combining the new coating with optimum tool geometry, the tool improves hole quality and longer tool life. Makes mechanical drilling cost competitive!

Label Sample



#001 $\phi D5.999$

Measured diameter is printed on the label.

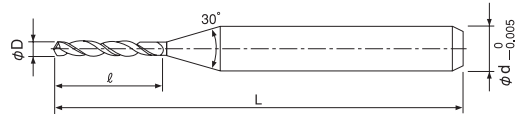

Point Angle : 130°

Diameter Tolerance : 0/-0.02 ($D \leq 3.5$)
0/-0.025 ($D \geq 4$)

Under-cut type

Enlarged tip drawing



$\phi 0.4 \sim \phi 7$

2 facet relief + "X" thinning
Designed for better biting

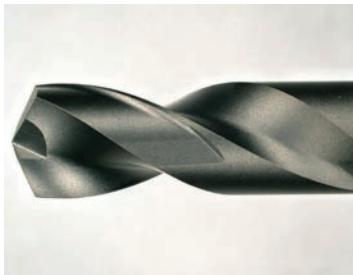
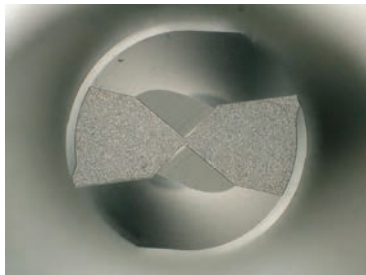

$\phi 0.3$ or below
Contact us for the request of below $\phi 0.3$.

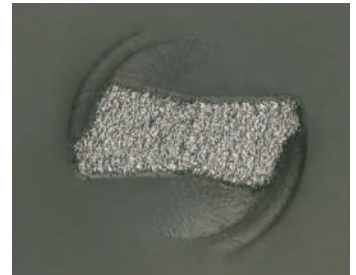

- $\phi 3$ mm Shank V Series
- UDC-PCD Series
- CBN Series
- Square
- Long Neck Square
- Radius
- Long Neck Radius
- Taper Neck Radius
- Ball / Long Shank Ball
- Long Neck Ball
- Taper Neck Ball
- Taper
- Barrel
- Spiral V Cutter
- Drill
- Technical Data

Total 35 models

Unit (mm)

Model Number	Diameter ϕD	Flute Length ℓ	Overall Length L	Shank Diameter ϕd	Suggested Retail Price ¥	Cemented Carbide		
						Spindle Speed (min ⁻¹)	Feed Rate (mm/min)	Peck Amount (mm)
UDCMX 2030-030	0.3	3	38	3	18,000	28,750	5	0.05
UDCMX 2040-040	0.4	4	38	3	18,000	20,000	5	0.05
UDCMX 2050-050	0.5	5	38	3	18,000	15,000	5	0.05
UDCMX 2060-060	0.6	6	38	3	18,000	11,500	5	0.05
UDCMX 2070-070	0.7	7	38	3	18,000	9,000	5	0.05
UDCMX 2080-080	0.8	8	38	3	18,000	7,300	7.5	0.05
UDCMX 2090-090	0.9	9	38	3	18,000	6,000	7.5	0.05
UDCMX 2100-100	1	10	38	3	18,000	5,000	7.5	0.05
UDCMX 2110-100	1.1	10	38	3	18,000	4,500	7.2	0.06
UDCMX 2120-100	1.2	10	38	3	18,000	4,100	6.8	0.07
UDCMX 2130-100	1.3	10	38	3	18,000	3,750	6.5	0.08
UDCMX 2140-100	1.4	10	38	3	18,000	3,450	6.2	0.09
UDCMX 2150-100	1.5	10	38	3	18,000	3,200	6	0.1
UDCMX 2160-100	1.6	10	38	3	18,000	3,000	6	0.1
UDCMX 2170-100	1.7	10	38	3	18,000	2,850	5.8	0.1
UDCMX 2180-100	1.8	10	38	3	18,000	2,700	5.5	0.1
UDCMX 2190-100	1.9	10	38	3	18,000	2,550	5.3	0.1
UDCMX 2200-100	2	10	38	3	18,000	2,400	5	0.15
UDCMX 2210-100	2.1	10	38	3	18,000	2,300	5	0.15
UDCMX 2220-100	2.2	10	38	3	18,000	2,225	5	0.15
UDCMX 2230-100	2.3	10	38	3	18,000	2,150	5	0.15
UDCMX 2240-100	2.4	10	38	3	18,000	2,075	5	0.15
UDCMX 2250-100	2.5	10	38	3	18,000	2,000	5	0.2
UDCMX 2300-100	3	10	38	3	18,000	1,100	3.7	0.25
UDCMX 2330-120	3.3	12	50	4	20,000	1,000	3.4	0.3
UDCMX 2350-120	3.5	12	50	4	20,000	910	3.3	0.35
UDCMX 2400-160	4	16	60	6	35,500	4,000	6.9	Single-Shot
UDCMX 2420-160	4.2	16	60	6	35,500	4,000	7.3	Single-Shot
UDCMX 2450-200	4.5	20	60	6	35,500	4,000	7.8	Single-Shot
UDCMX 2500-200	5	20	60	6	35,500	4,000	8.7	Single-Shot
UDCMX 2550-250	5.5	25	80	6	38,000	4,000	9.6	Single-Shot
UDCMX 2600-250	6	25	80	6	38,000	4,000	10.5	Single-Shot
UDCMX 2650-250	6.5	25	80	8	48,000	4,000	11.5	Single-Shot
UDCMX 2680-250	6.8	25	80	8	52,000	4,000	12	Single-Shot
UDCMX 2700-250	7	25	80	8	52,000	4,000	12.4	Single-Shot

These milling parameters are based on VM-40 (TAS standard) and are for reference only.

Tool life may differ depending on the type of Cemented Carbide material.

For best results, fine parameter adjustments may be required, depending on the Carbide material; milling shape and strategy; machine rigidity and spindle capability.

$\phi 3$ mm Shank
V Series

UDC-PCD
Series

CBN
Series

Square

Long Neck
Square

Radius

Long Neck
Radius

Taper Neck
Radius

Ball / Long
Shank Ball

Long Neck
Ball

Taper Neck
Ball

Taper

Barrel

Spiral
V Cutter

Drill

Technical Data

Note:

- Allow sufficient machine and spindle warm-up time for stability and to remove any expansion of the main spindle before running the program.
- Tool setting length should achieve the least possible overhang.
- Avoid contact with the coated area of the shank. This will prevent tip vibration and tool jamming in the collet / holder.
- Run-out and vibration should be checked dynamically at the tool point while mounted in the machine and both should achieve the lowest level possible.
- Recommend shallower drilling than flute length to promote good chip evacuation.
- Recommend using peck drilling cycle, but single-shot drilling may extend the tool life in some cases.
- Recommend air blow.
- Recommend water soluble coolant for Hard Brittle (Non-Metallic) Materials.
- Remove chips to prevent heat generation and ignition during milling process.
- Protective gear, such as safety glasses and face guards are required when milling.
- Chips / dust generated while milling can have adverse affects on the machine parts if they are not properly evacuated. Take steps to assure proper evacuation.
- Peck drilling is required depending on the hole quality & hole-edge chipping.
- We recommend to avoid operating the machine unattended when using large size tools with high MRR (Material Removal Rate) per hole. Rapid tool wear, sudden tool damage or breakage might occur depending on the processing environment.
- When milling some work pieces, heavier chips may be created.
To evacuate these chips it is important to accurately position the coolant nozzle on the milling part.

ø3mm Shank
V Series

UDC-PCD
Series

CBN
Series

Square

Long Neck
Square

Radius

Long Neck
Radius

Taper Neck
Radius

Ball / Long
Shank Ball

Long Neck
Ball

Taper Neck
Ball

Taper

Barrel

Spiral
V Cutter

Drill

Technical Data

Drilling Cemented Carbide - Stunning!

Cemented Carbide One-shot drilled with UDCMX $\phi 0.4 \times 4$ mm VM-40 (90HRA)

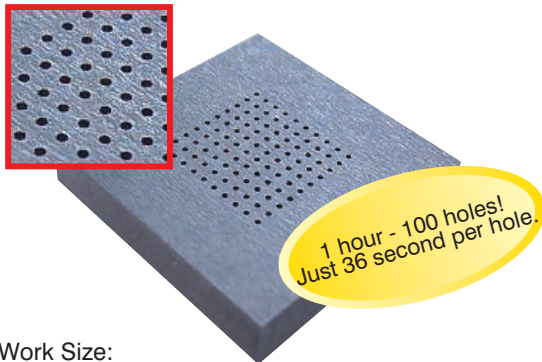

Work Size:
20 × 20 × 3 mm

Hole Quality after drilling 100 holes

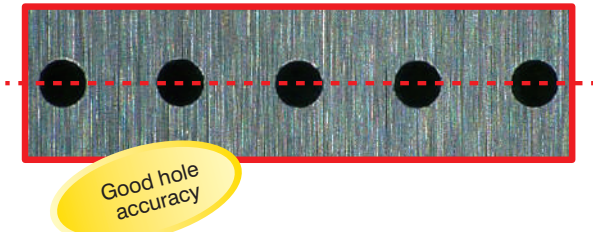

Tool	UDCMX 2040-040
Spindle Speed	20,000 min ⁻¹
Feed Rate	5 mm/min
Peck Amount	One-shot
Coolant	Air Blow (Nozzle)
Hole Specification	Blind Hole (Depth 2.8 mm × 100 holes)
Hole Pitch	1 mm
Cycle Time	36 sec per hole

Tool wear after drilling 100 holes

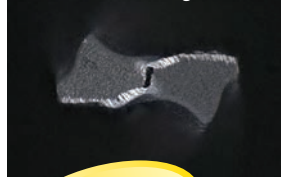

UDCMX
Drilling Video



Cemented Carbide VM-40 (90HRA)

Drilling with UDCMX ϕ 6.8 x Slot Length 25 mm >> Thread milling with UDCT M8



Work size :
50 x 50 x 25 mm

Milling Method	Drilling (one-shot)	Thread milling
Tool	UDCMX ϕ 6.8 x Slot Length 25 mm	UDCT M8-1.25-24
Spindle Speed	4,000 mm ⁻¹	3,500 mm ⁻¹
Feed Rate	12 mm/min	20 mm/min
Overhang Length	35 mm	30 mm
Coolant	Air Blow (Nozzle)	
Hole Specification	Blind hole Depth 20 mm x 25 holes	Depth 17.5 mm x 1 hole
Cycle Time	1 min 56 sec per hole	5 min 36 sec per hole



- UDCMX ϕ 6.8 : Drilled 25 holes with a single tool.
- More tool life left after drilling the 25th hole.
- Total material removal amount is about 17,000 mm³ when the cycle time is less than 1 hour.

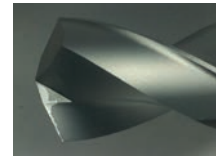

Hard Brittle Materials Drilling with UDCMX ϕ 1 x Slot Length 10 mm Aluminum Al₂O₃

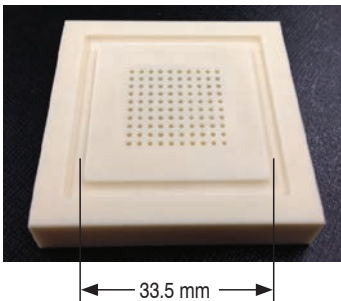

Spindle Speed	5,000 min ⁻¹
Feed Rate	7.5 mm/min
Peck Amount	0.05 mm
Coolant	Water Soluble
Hole Specification	Blind hole Depth 9 mm x 100 holes
Material Removal Amount	100 holes 700 mm ³ 7mm ³ per hole
Cycle Time	100 holes 8 h 46 min 5 min 16 sec per hole

100th drilled hole
No edge chipping

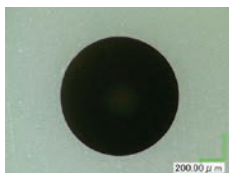

Drill tip after
drilling 100 holes.

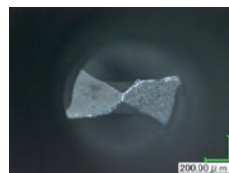

ϕ 3mm Shank
V Series

UDC-PCD
Series

CBN
Series

Square

Long Neck
Square

Radius

Long Neck
Radius

Taper Neck
Radius

Ball / Long
Shank Ball

Long Neck
Ball

Taper Neck
Ball

Taper

Barrel

Spiral
V Cutter

Drill

Technical Data



Size M2~M8



UDCT



Material Applications (★ Highly Recommended ● Recommended ○ Suggested)

Work Material																	
Carbon Steels S45C S55C	Alloy Steels SK / SCM SUS	Prehardened Steels NAK HPM	Hardened Steels					Cast Iron	Aluminum Alloys	Graphite	Copper	Plastics	Glass Filled Plastics	Titanium Alloys	Heat Resistant Alloys	Cemented Carbide	Hard Brittle (Non-Metallic) Materials
			~50HRC	~55HRC	~60HRC	~65HRC	~70HRC										
																★	●

* Hard Brittle (Non-Metallic) Materials: Ceramics (Alumina, Zirconia, etc.), Glasses etc.

Features

Thread Mills for Cemented Carbide and Hard Brittle (Non-Metallic) Materials.
Direct milling offers higher efficiency and precision comparing to EDM and grinding process.
Developed to give improved hardness and durability, UDC also has outstanding adhesion to the tool.
UDC series End Mills and Drills are recommended to drill holes before threading.

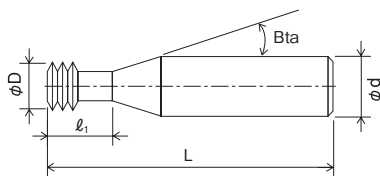

The shank taper angle shown is not an exact value and to avoid contact with the work piece, we recommend the user controls the precise value of this angle. Shank taper angle should not make contact with the work piece.

Label Sample

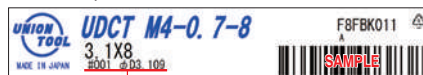

#001 φD3.109

Measured diameter is printed on the label.

Total 10 models

Unit (mm)

Model Number	Thread Diameter M	Pitch P	Tool Diameter φD	Number of Flutes	Effective Length l_1	Shank Taper Angle Bta	Overall Length L	Shank Diameter φd	Suggested Retail Price ¥
UDCT M2-0.4-4	M2	0.4	1.5	2	4	16°	50	4	38,900
UDCT M2.5-0.45-5	M2.5	0.45	1.9	2	5	16°	50	4	38,900
UDCT M3-0.5-6	M3	0.5	2.4	2	6	16°	50	4	38,900
UDCT M4-0.7-8	M4	0.7	3.1	2	8	16°	50	4	38,900
UDCT M5-0.8-10	M5	0.8	3.9	2	10	16°	60	6	42,800
UDCT M5-0.8-15					15		60		42,800
UDCT M6-1-12	M6	1	4.6	2	12	16°	60	6	42,800
UDCT M6-1-18					18		60		42,800
UDCT M8-1.25-16	M8	1.25	5.9	2	16	16°	60	6	42,800
UDCT M8-1.25-24					24		60		42,800

Milling Conditions for UDCT

Model Number	WORK MATERIAL			CEMENTED CARBIDE			
	Thread Diameter M	Pitch P	Tool Diameter ϕD	Effective Length l_1	Recommended Pilot Hole Diameter (mm)	Spindle Speed (mm ⁻¹)	Feed Rate (mm/min)
M2-0.4-4	M2	0.4	1.5	4	$\phi 1.6$	20,000	3
M2.5-0.45-5	M2.5	0.45	1.9	5	$\phi 2.1$	20,000	3
M3-0.5-6	M3	0.5	2.4	6	$\phi 2.5$	20,000	3
M4-0.7-8	M4	0.7	3.1	8	$\phi 3.3$	10,050	30
M5-0.8-10	M5	0.8	3.9	10	$\phi 4.2$	8,000	30
M5-0.8-15				15			
M6-1-12	M6	1	4.6	12	$\phi 5$	6,800	30
M6-1-18				18			
M8-1.25-16	M8	1.25	5.9	16	$\phi 6.8$	3,500	20
M8-1.25-24				24			

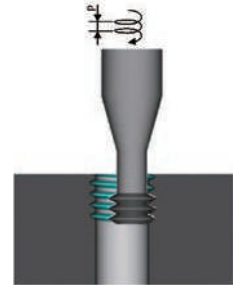

* Revised and reduced the spindle speed and feed rate for better tool life.

* These milling parameters are based on VM-40 (TAS standard) and are for reference only.

Tool life may differ depending on the type of Cemented Carbide material.

For best results, fine parameter adjustments may be required, depending on the Carbide material; milling shape and strategy; machine rigidity and spindle capability.

Note:

- This application requires a high cutting force. A machine with poor rigidity and high vibration is not recommended.
- Use a machine equipped with helical interpolating functions.
- Allow sufficient machine and spindle warm-up time for stability and to remove any expansion of the main spindle before running the program.
- Tool setting length should achieve the least possible overhang.
- Avoid contact with the coated area of the shank. This will prevent tip vibration and tool jamming in the collet / holder.
- Run-out and vibration should be checked dynamically at the tool point while mounted in the machine and both should achieve the lowest level possible.
- Decrease both spindle speed and feed rate proportionally.
- The feed rate is measured at the center of the tool.
- The radial cutting depth is recommended to cut all at once. Do not cut several times.
- Adjust turning radius amount to meet required internal thread precision.
- Air blow is highly recommended for longer tool life. Both oil mist and oil coolant are alternatives.
- Recommend water soluble coolant for Hard Brittle (Non-Metallic) Materials.
- When milling some work pieces, heavier chips may be created. To evacuate these chips it is important to accurately position the coolant nozzle on the milling part.
- Remove chips to prevent heat generation and ignition during milling process.
- Protective gear, such as safety glasses and face guards are required when milling.
- Chips / dust generated while milling can have adverse affects on the machine parts if they are not properly evacuated. Take steps to assure proper evacuation.

"Direct Drilling & Thread Milling" on Cemented Carbide!!

Cemented Carbide UDCMX $\phi 2.5$ (Hole Before Threading) + UDCT M3 (Thread Milling) VM-40(90HRA)

After drilling Holes
before threading



After thread milling



Work Size:
20 × 20 × 10 mm

	Hole Before Threading	Thread Milling
Tool	UDCMX 2250-100	UDCT M3-0.5-6
Spindle Speed	2,000 min ⁻¹	20,000 min ⁻¹
Feed Rate	5 mm/min	3 mm/min
Peck Amount	0.5 mm	—
Coolant	Air Blow (Nozzle)	
Hole Specification	Blind Hole Depth 8 mm x 16 holes	Depth 6 mm x 16 holes
Cycle Time	2 min 2 sec per hole	9 min 15 sec per hole

New standard for Cemented Carbide Processing

- Cracks are minimized.
- Time and cost savings comparing to EDM process.
- Highly precise thread geometry generated by single path threading.

$\phi 3$ mm Shank
V Series

UDC-PCD
Series

CBN
Series

Square

Long Neck
Square

Radius

Long Neck
Radius

Taper Neck
Radius

Ball / Long
Shank Ball

Long Neck
Ball

Taper Neck
Ball

Taper

Barrel

Spiral
V Cutter

Drill

Technical Data

CBN Series

CBN End Mills UNIMAX Series

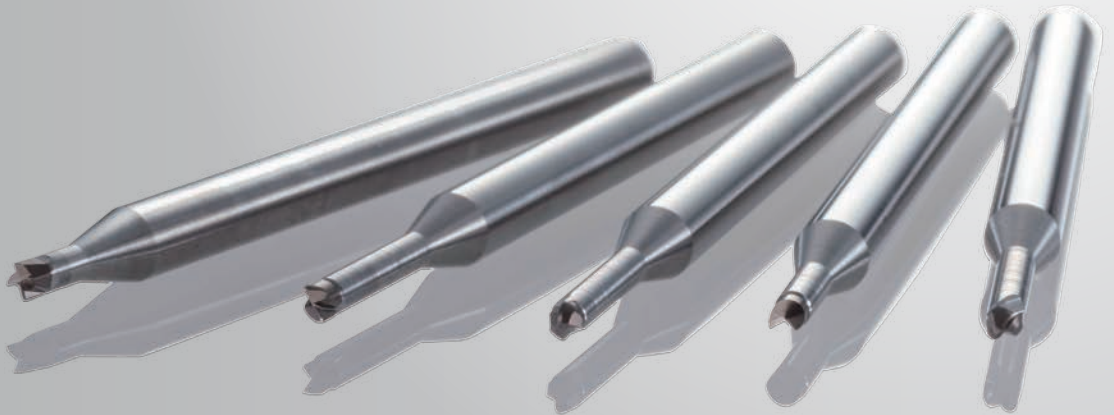

The 2 features of UNIMAX CBN series

Various lineup of tools

2 types each for Ball and Radius.
SF series offers shiny milling surfaces.

	Long Neck Ball			Long Neck Radius		
Type	Super mirror surface	Super surface finish	Long tool life	Super surface finish	Long tool life	
Series	CBN-PLB	CBN-LBSF	CBN-LBF	CBN-RSF	CBN-LRF 2000	CBN-LRF 4000
Flutes	2 Flutes	2 Flutes	2 Flutes	1 Flute	2 Flutes	4 Flutes
Helix angle	Non helix angle	Helix angle 20°	Non helix angle	Non helix angle	Non helix angle	Non helix angle
Tip geometry						
Page	120	122	126	132	136	146

High precision milling

Industry-leading high precision.
 The tool measurements are printed on the label to support High Precision milling.

	Long Neck Ball			Long Neck Radius		
Type	Super mirror surface	Super surface finish	Long tool life	Super surface finish	Long tool life	
Series	CBN-PLB	CBN-LBSF	CBN-LBF	CBN-RSF	CBN-LRF 2000	CBN-LRF 4000
R/CR Tolerance			 R0.05 - R1.5 R2	 CR≤0.02 CR≥0.05	 CR≤0.03 CR≥0.05	
Label sample	R tolerance	R tolerance	R tolerance / Diameter tolerance	CR tolerance / Diameter tolerance		

For super surface finish The features of CBN series

CBN-LBSF, CBN-RSF for super surface finish.
SF series offers shiny milling surfaces.

The power of **SF**

Ball

Milling surface comparison of Ball type



ELMAX (60HRC)
Size : $\phi 5 \times$ Depth 2.5 mm

Tool Size	R0.5 \times EL1.5
Spindle Speed	30,000 min ⁻¹
Feed Rate	750 mm/min
Cusp Height	0.0001 mm
Coolant	Oil Mist

CBN-LBSF For super surface finish



A cutting edge is set at the tip of the tool (zero peripheral speed).
Improved finishing surface by the burnishing effect on relief.

CBN-LBF For long tool life

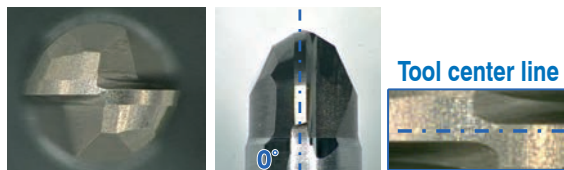

Non helix angle design ensures high rigidity.

Radius

Tool features of Radius type

CBN-RSF For super surface finish



1 flute design enables an even milling amount and prevents chip biting caused by runout.
The tool relief rubs against the milling surface to create a burnished finish.

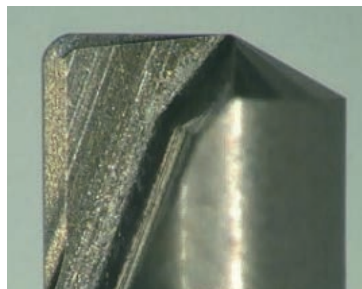
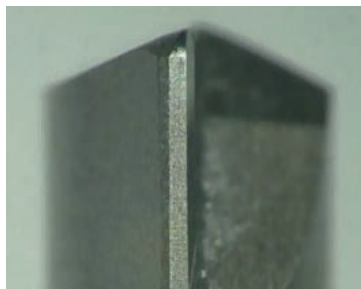

$\phi 3$ mm Shank
V Series

UDC-PCD
Series

CBN
Series

Square

Long Neck
Square

Radius

Long Neck
Radius

Taper Neck
Radius

Ball / Long
Shank Ball

Long Neck
Ball

Taper Neck
Ball

Taper

Barrel

Spiral
V Cutter

Drill

Technical Data



Size R0.2~R0.5

CBN-PLB



Patent pending

NEW

Material Applications (★ Highly Recommended ● Recommended ○ Suggested)

Work Material																	
Carbon Steels S45C S55C	Alloy Steels SK / SCM SUS	Prehardened Steels NAK HPM	Hardened Steels					Cast Iron	Aluminum Alloys	Graphite	Copper	Plastics	Glass Filled Plastics	Titanium Alloys	Heat Resistant Alloys	Cemented Carbide	Hard Brittle (Non-Metallic) Materials
			~50HRC	~55HRC	~60HRC	~65HRC	~70HRC										
		○	●	●	●	●	●										

φ3mm Shank V Series

UDC-PCD Series

CBN Series

Square
Long Neck Square

Radius

Long Neck Radius

Taper Neck Radius

Ball / Long Shank Ball

Long Neck Ball

Taper Neck Ball

Taper

Barrel

Spiral V Cutter

Drill

Technical Data

Features

1. CBN material featuring very high wear resistance.
2. Burnishing effect enables super mirror milling!
3. The slot design that allows coolant to reach the cutting edge.
Chip evacuation effect offers long tool life.
Prevention of repetitive chip cutting offers uniform milling surfaces.

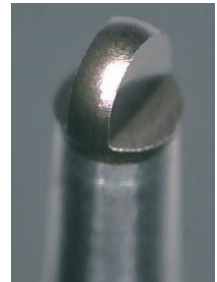

Label Sample

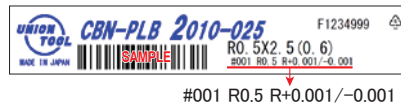

Ball Radius accuracy measurements are printed on the label to support High Precision milling.

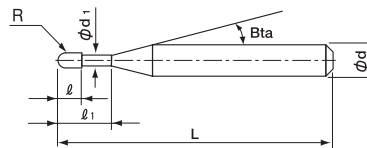

The shank taper angle shown is not an exact value and to avoid contact with the work piece, we recommend the user controls the precise value of this angle. Shank taper angle should not make contact with the work piece.

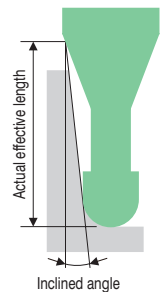

Total 3 models

Unit (mm)

Model Number	Radius of Ball Nose R	Effective Length ℓ ₁	Length of Cut ℓ	Neck Diameter φ _{d1}	Shank Taper Angle Bta	Overall Length L	Shank Diameter φ _d	Suggested Retail Price ¥	Effective Length by Inclined Angles				
									30°	1°	1°30'	2°	3°
CBN-PLB 2004-010	R0.2	1	0.24	0.38	15°	50	4	32,800	1.03	1.06	1.09	1.13	1.21
CBN-PLB 2006-015	R0.3	1.5	0.36	0.58	15°	50	4	30,800	1.53	1.57	1.62	1.68	1.79
CBN-PLB 2010-025	R0.5	2.5	0.6	0.98	15°	50	4	30,800	2.57	2.64	2.72	2.81	3.00

Milling Conditions for CBN-PLB

WORK MATERIAL			HEAT-TREATED STEELS / HARDENED STEELS STAVAX / ELMAX / HAP10 / HAP72 (~70HRC)			
Model Number	Radius of Ball Nose (mm)	Effective Length (mm)	Spindle Speed (min ⁻¹)	Feed Rate (mm/min)	a_p Axial Depth (mm)	a_e Radial Depth (mm)
2004-010	R0.2	1	30,000	150	0.001	0.001
2006-015	R0.3	1.5	30,000	300	0.002	0.002
2010-025	R0.5	2.5	30,000	375	0.003	0.003

Tool shape

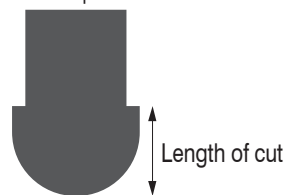

The length of cut that is 1.2 times the ball radius enables finishing on vertical surfaces.

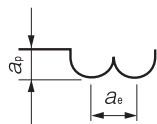

Note:

- Decrease both spindle speed and feed rate proportionally when the milling parameters exceed the machine's maximum spindle speed.
- Recommend oil mist to avoid tool damage.

Inclined surface milling 2 Flutes CBN-PLB R0.5 × EL2.5

ELMAX (60HRC)

Process	Finishing
Coolant	Oil Mist
Milling Method	Contour milling
Spindle Speed	30,000 min ⁻¹
Feed Rate	375 mm/min
Allowance	0.003 mm
Cycle Time	1 pocket 1 h 30 min

45° Inclined Surface

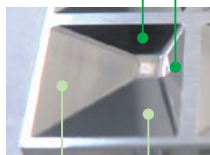

15° Inclined Surface

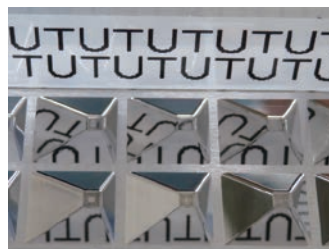

Surface roughness
15° Ra 0.014 μm
45° Ra 0.018 μm

Milling time and transition of Ra (Unit: μm)

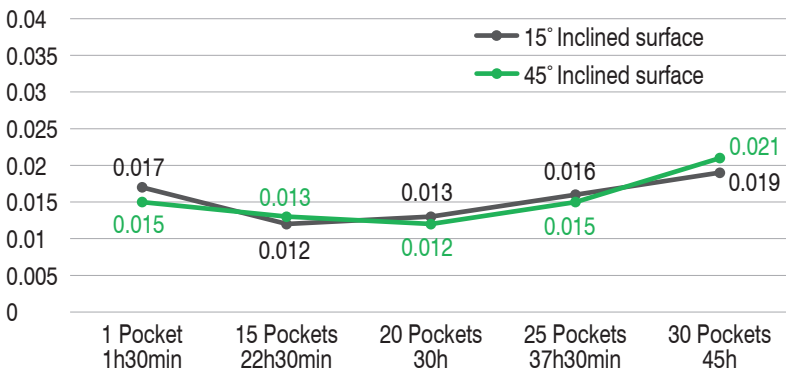

Only subtle difference in surface roughness after 45 hours.

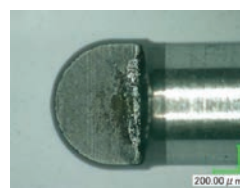
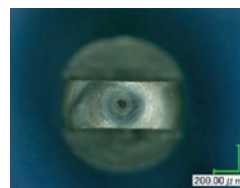

Tool after 45h of milling

φ3mm Shank
V Series

UDC-PCD
Series

CBN
Series

Square

Long Neck
Square

Radius

Long Neck
Radius

Taper Neck
Radius

Ball / Long
Shank Ball

Long Neck
Ball

Taper Neck
Ball

Taper

Barrel

Spiral
V Cutter

Drill

Technical Data



Size R0.05~R1

CBN-LBSF



Patented in Japan, China, Taiwan and Korea

Material Applications (★ Highly Recommended ● Recommended ○ Suggested)

Work Material																	
Carbon Steels	Alloy Steels	Prehardened Steels	Hardened Steels					Cast Iron	Aluminum Alloys	Graphite	Copper	Plastics	Glass Filled Plastics	Titanium Alloys	Heat Resistant Alloys	Cemented Carbide	Hard Brittle (Non-Metallic) Materials
			~50HRC	~55HRC	~60HRC	~65HRC	~70HRC										
S45C S55C	SK / SCM SUS	NAK HPM	○	●	●	●	●	○	○	○	○	○	○	○	○	○	○

Label Sample



#001 R1 R+0.001/0.000

Ball Radius accuracy measurements are printed on the label to support High Precision milling.

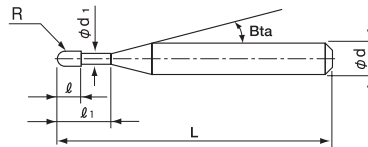

The shank taper angle shown is not an exact value and to avoid contact with the work piece, we recommend the user controls the precise value of this angle. Shank taper angle should not make contact with the work piece.

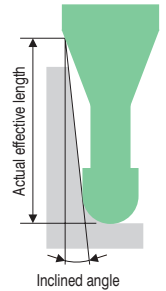

Features

For higher precision and better surface finish
Ball radius accuracy $\pm 0.002\text{mm}$ based on Nominal Radius.



A cutting edge is set at the tip of the tool (zero peripheral speed). Less tool damage and improved finishing surface.

Inclined surface milling CBN-LBF & CBN-LBSF comparison

ELMAX (60.5HRC)

Pocket Size : 9 × 9 × Depth 1.5 mm

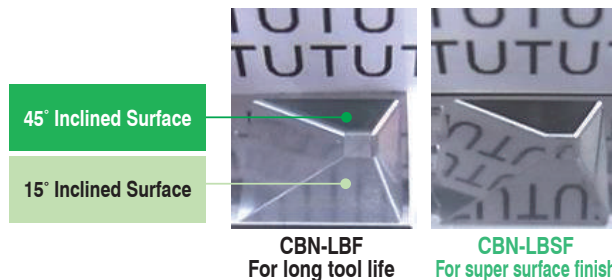

45° Inclined Surface

15° Inclined Surface

CBN-LBF
For long tool life

CBN-LBSF
For super surface finish

Surface Roughness after milling

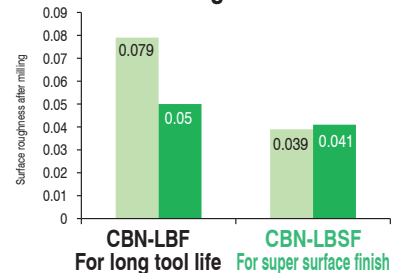

Milling method	Spindle Speed	Feed Rate	Allowance	Cusp height	Coolant	Cycle Time
Contour spiral milling	30,000 min ⁻¹	550 mm/min	0.005 mm	0.0001 mm	Oil mist	21.5 min

Lens application

2 Flutes CBN-LBSF R0.3 × EL1 · R1 × EL3

HAP10 (64HRC)

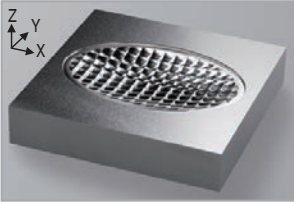

Surface Roughness after milling

Measurement point	Ra (μm)
Front point of Y axis	0.0272
Center point of Y axis	0.0172
Back point of Y axis	0.0304

CBN-LBSF
Milling video



Work Size : 100 × 100 × 20 mm
Coolant : Oil mist, Oil coolant

Shiny surface

No.	Process	Tool	Spindle Speed (min ⁻¹)	Feed Rate (mm/min)	a _p (mm)	a _e (mm)	Allowance (mm)	Cycle Time (h:m)
1	Roughing	HGB R2	9,480	2,400	0.18	0.75	0.08	1:01
2	Lens part/Semi-roughing		9,480	2,400	0.18	0.375	0.05	0:06
3	Periphery/Semi-roughing	HGB R1	14,700	2,160	0.1	0.35	0.05	0:07
4	Periphery/Semi-finishing1		14,700	2,160	0.1	0.1	0.02	0:03
5	Lens part/Semi-finishing1		14,700	2,160	0.03	0.1	0.02	0:36
6	Periphery/Semi-finishing2	HGB R0.5	21,000	1,750	0.04	0.04	0.005	0:15
7	Lens part/Semi-finishing2	HGB R1	14,700	2,160	0.015	0.05	0.005	1:13
8	Periphery/Finishing	CBN-LBSF R0.3 × EL1	30,000	600	0.01	0.01	0	2:56
9	Lens part/Finishing	CBN-LBSF R1 × EL3	24,000	750	0.005	0.018	0	4:52

Total 11:09

CBN-LBF/CBN-LBSF Surface roughness comparison

2 Flutes R0.5 × EL1.5

STAVAX (52HRC)

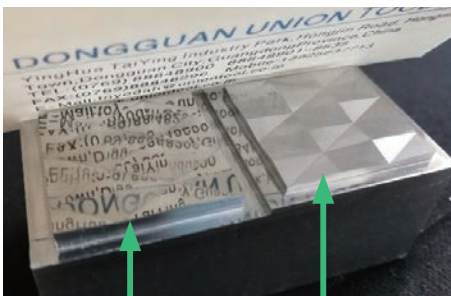

CBN-LBSF
For super surface
Ra 0.033 μm

CBN-LBF
For long tool life
Ra 0.159 μm

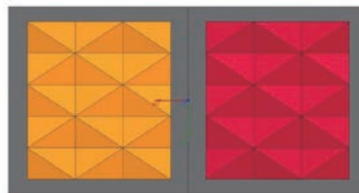

Size : 55 × 25 × 23 mm
Coolant : Oil mist

Spindle Speed (min ⁻¹)	Feed Rate (mm/min)	a _p (mm)	a _e (mm)	Cycle Time (h:m)
36,000	600	0.003	0.008	2:17

CBN-LBSF is recommended for excellent milling surface.
The surface finish is of such high quality that the letters reflect perfectly in it.

Ø3mm Shank
V Series

UDC-PCD
Series

CBN
Series

Square

Long Neck
Square

Radius

Long Neck
Radius

Taper Neck
Radius

Ball / Long
Shank Ball

Long Neck
Ball

Taper Neck
Ball

Taper

Barrel

Spiral
V Cutter

Drill

Technical Data

2 Flutes CBN Long Neck Ball End Mills for Super Finishing

Total 36 models

Shank taper angle Bta is only for reference

Unit (mm)

Model Number	Radius of Ball Nose R	Effective Length ℓ_1	Length of Cut ℓ	Neck Diameter ϕd_1	Shank Taper Angle Bta	Overall Length L	Shank Diameter ϕd	Suggested Retail Price ¥	Effective Length by Inclined Angles				
									30°	1°	1°30'	2°	3°
CBN-LBSF 2001-003	RO.05	0.3	0.07	0.09	15°	50	4	46,700	0.30	0.30	0.30	0.30	0.33
CBN-LBSF 2001-005		0.5							0.50	0.50	0.51	0.53	0.57
CBN-LBSF 20015-0045	RO.075	0.45	0.1	0.14	15°	50	4	46,700	0.45	0.45	0.46	0.48	0.51
CBN-LBSF 20015-0075		0.75							0.75	0.76	0.78	0.81	0.88
CBN-LBSF 2002-003	RO.1	0.3	0.13	0.19	15°	50	4	35,000	0.30	0.30	0.30	0.30	0.32
CBN-LBSF 2002-006		0.6							0.60	0.60	0.62	0.64	0.69
CBN-LBSF 2003-005	RO.15	0.5	0.22	0.28	15°	50	4	33,900	0.51	0.53	0.54	0.56	0.60
CBN-LBSF 2003-0075		0.75							0.77	0.79	0.82	0.85	0.91
CBN-LBSF 2003-009		0.9							0.91	0.94	0.97	1.01	1.08
CBN-LBSF 2004-0075	RO.2	0.75	0.32	0.38	15°	50	4	30,600	0.77	0.79	0.81	0.84	0.90
CBN-LBSF 2004-010		1							1.03	1.06	1.09	1.13	1.21
CBN-LBSF 2004-012		1.2							1.22	1.26	1.30	1.35	1.44
CBN-LBSF 2005-010	RO.25	1	0.4	0.48	15°	50	4	31,200	1.01	1.04	1.07	1.11	1.18
CBN-LBSF 2005-015		1.5							1.53	1.58	1.63	1.68	1.80
CBN-LBSF 2006-010	RO.3	1	0.48	0.58	15°	50	4	28,700	1.01	1.04	1.07	1.10	1.17
CBN-LBSF 2006-015		1.5							1.53	1.57	1.62	1.68	1.79
CBN-LBSF 2006-020		2							2.05	2.11	2.18	2.25	2.41
CBN-LBSF 2008-020	RO.4	2	0.6	0.78	15°	50	4	29,300	2.04	2.10	2.17	2.24	2.39
CBN-LBSF 2008-040		4							4.11	4.24	4.38	4.54	4.88
CBN-LBSF 2010-015		1.5							1.53	1.57	1.61	1.66	1.76
CBN-LBSF 2010-020	RO.5	2	0.7	0.98	15°	50	4	28,700	2.05	2.11	2.17	2.23	2.38
CBN-LBSF 2010-025		2.5							2.57	2.64	2.72	2.81	3.00
CBN-LBSF 2010-030		3							3.09	3.18	3.28	3.38	3.62
CBN-LBSF 2010-040		4							4.12	4.25	4.38	4.53	4.87
CBN-LBSF 2010-060		6							6.19	6.39	6.60	6.83	7.35
CBN-LBSF 2015-025	RO.75	2.5	0.9	1.46	15°	50	4	30,000	2.60	2.67	2.74	2.81	2.99
CBN-LBSF 2015-030		3							3.12	3.20	3.29	3.39	3.61
CBN-LBSF 2015-038		3.8							3.94	4.06	4.18	4.31	4.61
CBN-LBSF 2015-060		6							6.22	6.41	6.62	6.84	7.34
CBN-LBSF 2015-080		8							8.28	8.55	8.83	9.14	9.83
CBN-LBSF 2020-030	R1	3	1.2	1.97	15°	50	4	30,500	3.09	3.16	3.24	3.33	3.53
CBN-LBSF 2020-040		4							4.12	4.23	4.35	4.48	4.77
CBN-LBSF 2020-050		5							5.16	5.30	5.46	5.63	6.01
CBN-LBSF 2020-060		6							6.19	6.37	6.57	6.78	7.26
CBN-LBSF 2020-080		8							8.26	8.51	8.79	9.08	9.74
CBN-LBSF 2020-100		10							10.32	10.65	11.00	11.38	12.23

- $\phi 3\text{mm}$ Shank V Series
- UDC-PCD Series
- CBN Series
- Square
- Long Neck Square
- Radius
- Long Neck Radius
- Taper Neck Radius
- Ball / Long Shank Ball
- Long Neck Ball
- Taper Neck Ball
- Taper
- Barrel
- Spiral V Cutter
- Drill
- Technical Data

Milling Conditions for CBN-LBSF

WORK MATERIAL			HEAT-TREATED STEELS / HARDENED STEELS STAVAX / ELMAX / HAP10 / HAP72 (~68HRC)			
Model Number	Radius of Ball Nose (mm)	Effective Length (mm)	Spindle Speed (min ⁻¹)	Feed Rate (mm/min)	a_p Axial Depth (mm)	a_e Radial Depth (mm)
2001-003	R0.05	0.3	30,000	70	0.003 MAX	0.006 MAX
2001-005		0.5	30,000	70	0.002 MAX	0.006 MAX
20015-0045	R0.075	0.45	30,000	150	0.004 MAX	0.008 MAX
20015-0075		0.75	30,000	125	0.004 MAX	0.008 MAX
2002-003	R0.1	0.3	30,000	240	0.005 MAX	0.01 MAX
2002-006		0.6	30,000	200	0.005 MAX	0.01 MAX
2003-005	R0.15	0.5	30,000	300	0.005 MAX	0.01 MAX
2003-0075		0.75	30,000	250	0.005 MAX	0.01 MAX
2003-009		0.9	30,000	250	0.005 MAX	0.01 MAX
2004-0075	R0.2	0.75	30,000	360	0.005 MAX	0.01 MAX
2004-010		1	30,000	300	0.005 MAX	0.01 MAX
2004-012		1.2	30,000	300	0.005 MAX	0.01 MAX
2005-010	R0.25	1	30,000	420	0.005 MAX	0.01 MAX
2005-015		1.5	30,000	350	0.005 MAX	0.01 MAX
2006-010	R0.3	1	30,000	500	0.01 MAX	0.015 MAX
2006-015		1.5	30,000	500	0.01 MAX	0.015 MAX
2006-020		2	30,000	350	0.01 MAX	0.015 MAX
2008-020	R0.4	2	30,000	620	0.01 MAX	0.015 MAX
2008-040		4	30,000	420	0.01 MAX	0.015 MAX
2010-015		1.5	30,000	750	0.01 MAX	0.02 MAX
2010-020	R0.5	2	30,000	750	0.01 MAX	0.02 MAX
2010-025		2.5	30,000	750	0.01 MAX	0.02 MAX
2010-030		3	30,000	500	0.01 MAX	0.02 MAX
2010-040		4	30,000	500	0.01 MAX	0.02 MAX
2010-060	R0.75	6	30,000	330	0.01 MAX	0.02 MAX
2015-025		2.5	20,000	750	0.01 MAX	0.02 MAX
2015-030		3	20,000	750	0.01 MAX	0.02 MAX
2015-038		3.8	20,000	750	0.01 MAX	0.02 MAX
2015-060		6	20,000	500	0.01 MAX	0.02 MAX
2015-080	8	20,000	500	0.01 MAX	0.02 MAX	
2020-030	R1	3	15,000	750	0.01 MAX	0.025 MAX
2020-040		4	15,000	750	0.01 MAX	0.025 MAX
2020-050		5	15,000	750	0.01 MAX	0.025 MAX
2020-060		6	15,000	500	0.01 MAX	0.025 MAX
2020-080		8	15,000	500	0.01 MAX	0.025 MAX
2020-100		10	15,000	500	0.01 MAX	0.025 MAX

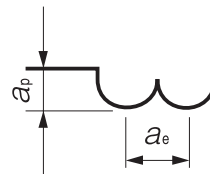

Note:

- Decrease both spindle speed and feed rate proportionally when the milling parameters exceed the machine's maximum spindle speed.
- Recommend oil mist to avoid tool damage.

Ø3mm Shank
V Series

UDC-PCD
Series

CBN
Series

Square

Long Neck
Square

Radius

Long Neck
Radius

Taper Neck
Radius

Ball / Long
Shank Ball

Long Neck
Ball

Taper Neck
Ball

Taper

Barrel

Spiral
V Cutter

Drill

Technical Data



Size R0.05~R2

CBN-LBF



Additional 6 models

Material Applications (★ Highly Recommended ● Recommended ○ Suggested)

Work Material																	
Carbon Steels	Alloy Steels	Prehardened Steels	Hardened Steels					Cast Iron	Aluminum Alloys	Graphite	Copper	Plastics	Glass Filled Plastics	Titanium Alloys	Heat Resistant Alloys	Cemented Carbide	Hard Brittle (Non-Metallic) Materials
			~50HRC	~55HRC	~60HRC	~65HRC	~70HRC										
S45C S55C	SK / SCM SUS	NAK HPM	○	●	●	●	●										

Label Sample



#001 ϕ D0.600 R+0.003/0.000

Diameter and Ball Radius accuracy measurements are printed on the label to support High Precision milling.

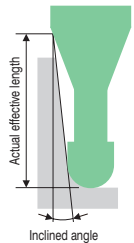
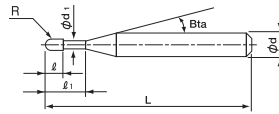

The shank taper angle shown is not an exact value and to avoid contact with the work piece, we recommend the user controls the precise value of this angle. Shank taper angle should not make contact with the work piece.

Features

For long tool life
Various lineup from R0.05 to R2.

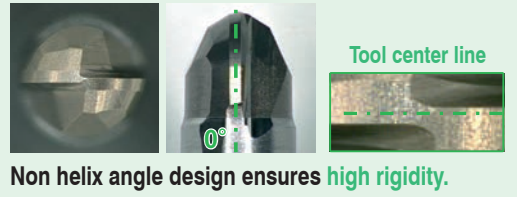

Non helix angle design ensures high rigidity.

Reflector mold finishing 2 Flutes CBN-LBF R0.15 × EL0.9

SKD11 (60HRC)

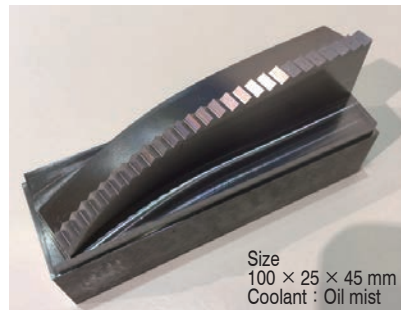

Size 100 × 25 × 45 mm
Coolant : Oil mist



No.	Tool	Spindle Speed (min ⁻¹)	Feed Rate (mm/min)	a _o (mm)	a _e (mm)	Cycle Time (h:m:s)
1	HSB R1.5	15,000	800	0.06	0.06	0:25:37
2	HSB R0.5	20,000	500	0.025	0.025	1:11:53
3	HSB R0.25	25,000	350	0.02	0.02	0:34:29
4	HSB R0.15	30,000	300	0.015	0.015	0:30:55
5	CBN-LBF R0.15 × EL0.9	30,000	300	0.008	0.008	3:48:13

Total 6:31:07

- 3mm Shank V Series
- UDC-PCD Series
- CBN Series
- Square
- Long Neck Square
- Radius
- Long Neck Radius
- Taper Neck Radius
- Ball / Long Shank Ball
- Long Neck Ball
- Taper Neck Ball
- Taper
- Barrel
- Spiral V Cutter
- Drill
- Technical Data

Convex shaped finishing
2 Flutes CBN-LBF/CBN-LBSF R0.3 × EL1.5

STAVAX (52HRC)

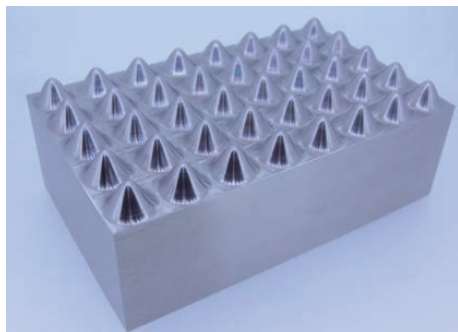

Work Size : 80 × 50 × 30 mm
 Coolant : Oil mist

Process	Finishing
Milling Method	Contour spiral milling
Spindle Speed	30,000 min ⁻¹
Feed Rate	800 mm/min
Cusp Height	0.0001 mm
a_e	0.015 mm
Cycle Time	9:48 h:m

Work piece dimensional error after milling

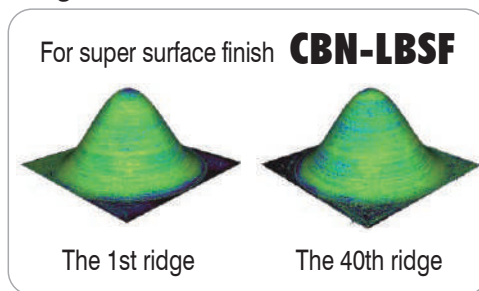
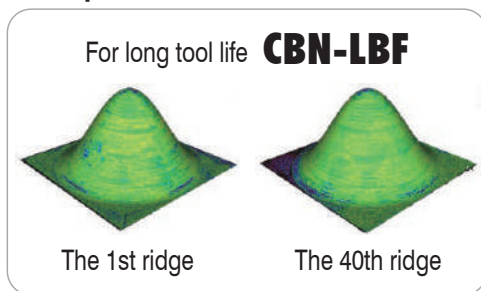

(μm)



Both types are able to mill for a long time while maintaining accuracy.

Milling time 1 ridge : 12 min 30 sec, 40 ridges : 8 h 20 min,

Milling surface comparison

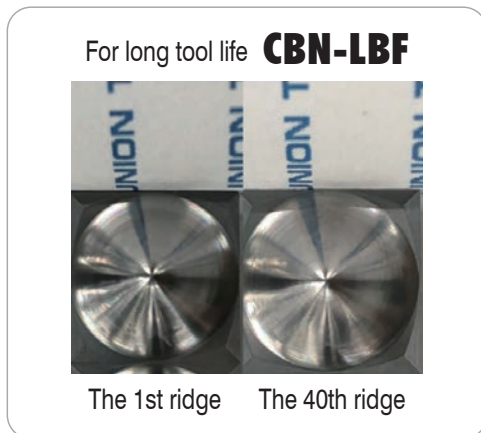

CBN-LBF for high efficiency milling and long tool life.



CBN-LBSF offers shiny milling surfaces.

Ø3mm Shank
V Series

UDC-PCD
Series

CBN
Series

Square
Long Neck
Square

Radius
Long Neck
Radius

Radius
Taper Neck
Radius

Ball / Long
Shank Ball
Long Neck
Ball

Taper
Taper

Barrel
Spiral
V Cutter

Drill

Technical Data

Reflector mold finishing
2 Flutes CBN-LBF R0.4 × EL2

STAVAX (52HRC)

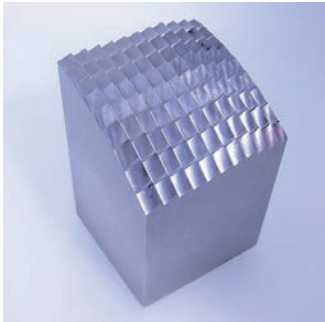

CBN-LBF
 Milling video of
 reflector mold for
 finishing



No	Process	Tool	Spindle Speed (min ⁻¹)	Feed Rate (mm/min)	a _p (mm)	a _e (mm)	Cycle Time (h:m:s)
1	Roughing	HRRS φ6 × CR1 × EL18	3,500	2,500	0.2	2	0:18:00
2	Semi-roughing	HRRS φ6 × CR1 × EL18	9,000	2,500	0.05	0.1	0:13:35
3	Semi-roughing	HRRS φ2 × CR0.3 × EL6	3,500	1,000	0.04	1	0:33:55
4	Semi-finishing	HSB R1.5	12,000	2,500	0.02	0.07	0:12:24
5	Semi-finishing	HSB R0.75	7,000	1,000	0.04	0.07	0:20:50
6	Semi-finishing	HSB R0.75	7,000	700	0.05	0.05	0:18:08
7	Semi-finishing	HSB R0.5	8,000	500	0.02	0.03	0:23:24
8	Semi-finishing	HSB R0.5	15,000	1,200	0.02	0.03	1:30:33
9	Finishing	CBN-LBF R0.4 × EL2	26,000	800	0.01	0.004	10:12:54

Total 14:03:43

Total 64 models

*Shank taper angle Bta is only for reference.

Unit (mm)

Model Number	Radius of Ball Nose R	Effective Length ℓ ₁	Length of Cut ℓ	Neck Diameter φ _{d1}	Shank Taper Angle Bta	Overall Length L	Shank Diameter φ _d	Suggested Retail Price ¥	Effective Length by Inclined Angles									
									30°	1°	1°30'	2°	3°					
CBN-LBF 2001-003	R0.05	0.3	0.08	0.09	15°	50	4	42,400	0.30	0.30	0.30	0.30	0.33					
CBN-LBF 2001-005		0.5												0.50	0.50	0.51	0.53	0.57
CBN-LBF 20015-0045	R0.075	0.45	0.15	0.14	15°	50	4	42,400	0.45	0.45	0.46	0.48	0.51					
CBN-LBF 20015-0075		0.75												0.75	0.76	0.78	0.81	0.88
CBN-LBF 2002-003	R0.1	0.3	0.16	0.19	15°	50	4	28,800	0.30	0.30	0.30	0.30	0.32					
CBN-LBF 2002-006		0.6												0.60	0.60	0.62	0.64	0.69
CBN-LBF 2002-010		1												1.00	1.03	1.06	1.10	1.19
CBN-LBF 2003-005	R0.15	0.5	0.24	0.28	15°	50	4	28,800	0.51	0.53	0.54	0.56	0.60					
CBN-LBF 2003-0075		0.75												0.77	0.79	0.82	0.85	0.91
CBN-LBF 2003-009		0.9												0.91	0.94	0.96	1.00	1.06
CBN-LBF 2003-015		1.5												1.53	1.58	1.63	1.68	1.80
CBN-LBF 2004-005	R0.2	0.5	0.32	0.38	15°	50	4	27,700	0.51	0.52	0.54	0.55	0.58					
CBN-LBF 2004-0075		0.75												0.77	0.79	0.81	0.84	0.90
CBN-LBF 2004-010		1												1.03	1.06	1.09	1.13	1.21
CBN-LBF 2004-012		1.2												1.22	1.25	1.29	1.33	1.42
CBN-LBF 2004-020		2												2.04	2.10	2.17	2.24	2.40
CBN-LBF 2004-030	3	3.07	3.17	3.27	3.38	3.62												
CBN-LBF 2005-010	R0.25	1	0.4	0.48	15°	50	4	27,700	1.02	1.05	1.08	1.12	1.19					
CBN-LBF 2005-015		1.5												1.53	1.57	1.62	1.66	1.78
CBN-LBF 2005-025		2.5												2.56	2.63	2.72	2.80	3.00
CBN-LBF 2005-035		3.5												3.59	3.70	3.82	3.94	4.22

Unit (mm)

Model Number	Radius of Ball Nose R	Effective Length l_1	Length of Cut l	Neck Diameter ϕd_1	Shank Taper Angle Bta	Overall Length L	Shank Diameter ϕd	Suggested Retail Price ¥	Effective Length by Inclined Angles				
									30°	1°	1°30'	2°	3°
CBN-LBF 2006-010	RO.3	1	0.48	0.58	15°	50	4	26,600	1.02	1.05	1.08	1.11	1.18
CBN-LBF 2006-015		1.5				50	4	26,600	1.52	1.57	1.61	1.66	1.76
CBN-LBF 2006-030		3				50	4	28,400	3.07	3.16	3.26	3.37	3.60
CBN-LBF 2006-040		4				50	4	28,400	4.10	4.23	4.36	4.50	4.82
CBN-LBF 2006-050		5				50	4	28,800	5.13	5.29	5.46	5.64	6.05
CBN-LBF 2006-060		6				50	4	31,600	6.17	6.36	6.56	6.78	7.27
CBN-LBF 2008-020	RO.4	2	0.6	0.78	15°	50	4	26,600	2.04	2.09	2.15	2.21	2.35
CBN-LBF 2008-040		4				50	4	28,400	4.10	4.22	4.35	4.49	4.80
CBN-LBF 2008-060		6				50	4	31,100	6.16	6.35	6.55	6.77	7.25
CBN-LBF 2010-015	RO.5	1.5	0.7	0.98	15°	50	4	26,600	1.53	1.57	1.61	1.66	1.76
CBN-LBF 2010-020		2				50	4	26,600	2.05	2.11	2.17	2.23	2.38
CBN-LBF 2010-025		2.5				50	4	26,600	2.56	2.63	2.70	2.78	2.96
CBN-LBF 2010-040		4				50	4	28,400	4.11	4.23	4.35	4.49	4.79
CBN-LBF 2010-050		5				50	4	28,400	5.14	5.29	5.45	5.63	6.02
CBN-LBF 2010-060		6				50	4	28,400	6.17	6.36	6.55	6.77	7.24
CBN-LBF 2010-080		8				50	4	28,800	8.23	8.49	8.76	9.04	9.69
CBN-LBF 2010-100		10				50	4	29,500	10.30	10.62	10.96	11.32	12.13
CBN-LBF 2012-024	RO.6	2.4	0.8	1.18	15°	50	4	27,700	2.46	2.53	2.60	2.68	2.85
CBN-LBF 2012-030		3				50	4	27,700	3.08	3.17	3.27	3.37	3.60
CBN-LBF 2012-060		6				50	4	32,200	6.18	6.38	6.59	6.82	7.33
CBN-LBF 2015-030	RO.75	3	0.9	1.46	15°	50	4	27,700	3.12	3.20	3.29	3.39	3.61
CBN-LBF 2015-040		4				50	4	27,700	4.15	4.27	4.40	4.54	4.85
CBN-LBF 2015-060		6				50	4	27,700	6.22	6.41	6.62	6.84	7.34
CBN-LBF 2015-080		8				50	4	30,600	8.28	8.55	8.83	9.14	9.83
CBN-LBF 2015-100		10				50	4	32,200	10.35	10.69	11.05	11.44	12.31
CBN-LBF 2015-120		12				50	4	32,200	12.42	12.83	13.27	13.74	14.80
CBN-LBF 2015-150		15				50	4	32,200	15.52	16.04	16.59	17.19	18.53
CBN-LBF 2020-040		R1				4	1.2	1.97	15°	50	4	27,700	4.12
CBN-LBF 2020-050	5		50	4	27,700	5.16				5.30	5.46	5.63	6.01
CBN-LBF 2020-060	6		50	4	27,700	6.19				6.37	6.57	6.78	7.26
CBN-LBF 2020-080	8		50	4	30,600	8.26				8.51	8.79	9.08	9.74
CBN-LBF 2020-100	10		50	4	30,600	10.32				10.65	11.00	11.38	12.23
CBN-LBF 2020-120	12		50	4	32,200	12.39				12.79	13.22	13.68	14.72
CBN-LBF 2020-140	14		50	4	32,700	14.46				14.93	15.44	15.98	17.20
CBN-LBF 2020-160	16		50	4	32,700	16.53				17.07	17.65	18.28	19.69
CBN-LBF 2020-180	18		50	4	32,700	18.59				19.21	19.87	20.58	No Interference
CBN-LBF 2020-200	20		50	4	32,700	20.66				21.35	22.09	22.88	No Interference
※ CBN-LBF 2030-040	R1.5	4	1.8	2.94	15°	50	6	29,260	4.16	4.26	4.36	4.47	4.72
※ CBN-LBF 2030-060		6				50	6	29,260	6.23	6.40	6.58	6.77	7.21
※ CBN-LBF 2030-080		8				50	6	29,260	8.30	8.54	8.79	9.07	9.70
※ CBN-LBF 2040-060	R2	6	2.4	3.95	15°	50	6	35,320	6.21	6.36	6.52	6.70	7.09
※ CBN-LBF 2040-080		8				50	6	35,320	8.28	8.50	8.74	9.00	9.57
※ CBN-LBF 2040-100		10				50	6	35,320	10.35	10.64	10.96	11.30	12.06

※Additional model

Ø3mm Shank
V SeriesUDC-PCD
SeriesCBN
Series

Square

Long Neck
Square

Radius

Long Neck
RadiusTaper Neck
RadiusBall / Long
Shank BallLong Neck
BallTaper Neck
Ball

Taper

Barrel

Spiral
V Cutter

Drill

Technical Data

Milling Conditions for CBN-LBF

WORK MATERIAL			HEAT-TREATED STEELS / HARDENED STEELS STAVAX (~52HRC)				HARDENED STEELS SKD11 (~62HRC)				HARDENED STEELS HAP10 / HAP72 (~68HRC)			
Model Number	Radius of Ball Nose (mm)	Effective Length (mm)	Spindle Speed (min ⁻¹)	Feed Rate (mm/min)	a _p Axial Depth (mm)	a _e Radial Depth (mm)	Spindle Speed (min ⁻¹)	Feed Rate (mm/min)	a _p Axial Depth (mm)	a _e Radial Depth (mm)	Spindle Speed (min ⁻¹)	Feed Rate (mm/min)	a _p Axial Depth (mm)	a _e Radial Depth (mm)
2001-003	R0.05	0.3	30,000	200	0.005	0.005	30,000	150	0.003	0.005	30,000	100	0.002	0.005
2001-005		0.5	30,000	150	0.003	0.005	30,000	120	0.003	0.005	30,000	90	0.002	0.005
20015-0045	R0.075	0.45	30,000	350	0.005	0.005	30,000	270	0.004	0.005	30,000	200	0.003	0.005
20015-0075		0.75	30,000	220	0.004	0.005	30,000	160	0.004	0.005	30,000	100	0.003	0.005
2002-003	R0.1	0.3	30,000	660	0.005	0.005	30,000	550	0.005	0.005	30,000	440	0.005	0.005
2002-006		0.6	30,000	500	0.005	0.005	30,000	400	0.005	0.005	30,000	300	0.005	0.005
2002-010		1	30,000	290	0.005	0.005	30,000	200	0.005	0.005	30,000	120	0.005	0.005
2003-005	R0.15	0.5	30,000	1,000	0.005	0.005	30,000	950	0.005	0.005	30,000	620	0.005	0.005
2003-0075		0.75	30,000	850	0.005	0.005	30,000	800	0.005	0.005	30,000	500	0.005	0.005
2003-009		0.9	30,000	760	0.005	0.005	30,000	600	0.005	0.005	30,000	430	0.005	0.005
2003-015		1.5	30,000	460	0.005	0.005	30,000	320	0.005	0.005	30,000	190	0.005	0.005
2004-005	R0.2	0.5	30,000	1,580	0.005	0.01	30,000	1,330	0.005	0.01	30,000	860	0.005	0.005
2004-0075		0.75	30,000	1,390	0.005	0.01	30,000	1,140	0.005	0.01	30,000	800	0.005	0.005
2004-010		1	30,000	1,200	0.005	0.01	30,000	950	0.005	0.01	30,000	730	0.005	0.005
2004-012		1.2	30,000	1,050	0.005	0.01	30,000	800	0.005	0.01	30,000	620	0.005	0.005
2004-020		2	30,000	600	0.005	0.01	30,000	450	0.005	0.01	30,000	330	0.005	0.005
2004-030	R0.25	3	20,000	400	0.005	0.005	20,000	300	0.005	0.005	20,000	190	0.003	0.003
2005-010		1	30,000	1,600	0.01	0.01	30,000	1,300	0.01	0.01	30,000	920	0.005	0.01
2005-015		1.5	30,000	1,300	0.01	0.01	30,000	1,000	0.01	0.01	30,000	760	0.005	0.01
2005-025		2.5	30,000	800	0.01	0.01	30,000	700	0.01	0.01	30,000	480	0.005	0.01
2005-035		3.5	22,000	550	0.01	0.01	22,000	500	0.005	0.01	22,000	330	0.005	0.005
2006-010	R0.3	1	30,000	2,400	0.02	0.03	30,000	1,900	0.02	0.03	30,000	1,080	0.01	0.02
2006-015		1.5	30,000	2,000	0.02	0.03	30,000	1,500	0.02	0.03	30,000	1,000	0.01	0.02
2006-030		3	26,000	1,100	0.02	0.02	26,000	900	0.02	0.02	26,000	760	0.01	0.01
2006-040		4	22,000	750	0.01	0.02	22,000	650	0.01	0.02	22,000	570	0.005	0.01
2006-050		5	18,000	550	0.01	0.01	18,000	450	0.01	0.01	18,000	410	0.005	0.005
2006-060		6	12,000	350	0.005	0.01	12,000	290	0.005	0.005	12,000	260	0.003	0.003
2008-020	R0.4	2	30,000	2,500	0.02	0.03	30,000	2,100	0.02	0.03	30,000	1,700	0.01	0.02
2008-040		4	25,000	1,500	0.02	0.02	25,000	1,350	0.02	0.02	25,000	1,200	0.01	0.01
2008-060		6	18,000	1,000	0.01	0.02	18,000	800	0.01	0.02	18,000	750	0.005	0.01
2010-015	R0.5	1.5	30,000	3,700	0.04	0.05	30,000	3,400	0.03	0.04	30,000	2,300	0.025	0.03
2010-020		2	30,000	3,500	0.04	0.04	30,000	3,200	0.03	0.04	30,000	2,200	0.02	0.03
2010-025		2.5	30,000	3,300	0.04	0.04	30,000	3,000	0.03	0.04	30,000	2,100	0.02	0.03
2010-040		4	27,000	2,700	0.03	0.04	27,000	2,300	0.03	0.03	27,000	1,800	0.02	0.02
2010-050		5	23,000	2,200	0.03	0.03	23,000	1,800	0.03	0.03	23,000	1,450	0.02	0.02
2010-060		6	20,000	1,900	0.02	0.03	20,000	1,500	0.02	0.03	20,000	1,200	0.01	0.02
2010-080		8	14,000	1,300	0.01	0.02	14,000	1,000	0.01	0.02	14,000	800	0.01	0.01
2010-100		10	9,000	800	0.01	0.02	9,000	600	0.01	0.01	9,000	490	0.005	0.005

φ3mm Shank V Series

UDC-PCD Series

CBN Series

Square
Long Neck Square

Radius

Radius
Long Neck Radius
Taper Neck Radius

Ball / Long Shank Ball
Long Neck Ball

Taper Neck Ball

Taper

Barrel

Spiral V Cutter

Drill

Technical Data

Milling Conditions for CBN-LBF

WORK MATERIAL			HEAT-TREATED STEELS / HARDENED STEELS STAVAX (~52HRC)				HARDENED STEELS SKD11 (~62HRC)				HARDENED STEELS HAP10 / HAP72 (~68HRC)			
Model Number	Radius of Ball Nose (mm)	Effective Length (mm)	Spindle Speed (min ⁻¹)	Feed Rate (mm/min)	a_p Axial Depth (mm)	a_e Radial Depth (mm)	Spindle Speed (min ⁻¹)	Feed Rate (mm/min)	a_p Axial Depth (mm)	a_e Radial Depth (mm)	Spindle Speed (min ⁻¹)	Feed Rate (mm/min)	a_p Axial Depth (mm)	a_e Radial Depth (mm)
2012-024	R0.6	2.4	30,000	3,000	0.05	0.05	29,500	2,550	0.035	0.04	29,000	2,100	0.02	0.03
2012-030		3	30,000	2,750	0.05	0.05	29,000	2,350	0.035	0.035	28,000	2,000	0.02	0.025
2012-060		6	23,500	2,000	0.03	0.03	23,500	1,650	0.025	0.025	23,500	1,300	0.02	0.02
2015-030	R0.75	3	30,000	3,000	0.07	0.07	28,500	2,550	0.045	0.05	27,000	2,100	0.02	0.03
2015-040		4	28,500	2,750	0.06	0.06	27,250	2,300	0.04	0.04	26,000	1,900	0.02	0.025
2015-060		6	26,000	2,200	0.04	0.045	25,500	1,900	0.03	0.03	25,000	1,650	0.02	0.02
2015-080		8	24,000	2,000	0.025	0.03	24,000	1,700	0.02	0.025	24,000	1,400	0.015	0.02
2015-100		10	16,000	1,300	0.02	0.02	16,000	1,100	0.015	0.018	16,000	900	0.01	0.015
2015-120		12	12,000	1,000	0.016	0.018	12,000	880	0.012	0.016	12,000	730	0.008	0.012
2015-150		15	6,000	600	0.01	0.015	6,000	550	0.008	0.012	6,000	490	0.005	0.008
2020-040	R1	4	30,000	3,000	0.1	0.1	27,000	2,550	0.06	0.065	24,000	2,100	0.02	0.03
2020-050		5	28,000	2,750	0.08	0.08	26,000	2,300	0.05	0.05	24,000	1,900	0.02	0.025
2020-060		6	27,000	2,500	0.05	0.06	25,500	2,050	0.035	0.04	24,000	1,650	0.015	0.025
2020-080		8	25,000	2,200	0.035	0.045	24,500	1,800	0.025	0.03	24,000	1,400	0.015	0.02
2020-100		10	24,000	2,000	0.02	0.03	24,000	1,600	0.015	0.025	24,000	1,200	0.01	0.02
2020-120		12	19,500	1,600	0.017	0.025	19,500	1,300	0.013	0.021	19,500	1,000	0.009	0.017
2020-140		14	15,000	1,250	0.015	0.02	15,000	1,050	0.012	0.018	15,000	850	0.008	0.015
2020-160		16	11,500	990	0.013	0.017	11,500	860	0.011	0.015	11,500	730	0.007	0.013
2020-180		18	8,000	740	0.012	0.013	8,000	670	0.009	0.013	8,000	610	0.006	0.012
2020-200		20	4,500	490	0.01	0.01	4,500	490	0.008	0.01	4,500	490	0.005	0.01
2030-040	R1.5	4	20,000	2,500	0.1	0.15	18,000	2,200	0.06	0.09	16,000	1,900	0.04	0.06
2030-060		6	20,000	2,500	0.1	0.15	18,000	2,200	0.06	0.09	16,000	1,900	0.04	0.06
2030-080		8	18,000	2,200	0.08	0.12	17,000	2,000	0.05	0.075	16,000	1,650	0.04	0.05
2040-060	R2	6	17,000	2,500	0.12	0.18	15,000	2,200	0.08	0.12	13,000	1,900	0.05	0.08
2040-080		8	17,000	2,500	0.12	0.18	15,000	2,200	0.08	0.12	13,000	1,900	0.05	0.08
2040-100		10	16,000	2,200	0.1	0.15	14,000	2,000	0.06	0.09	13,000	1,650	0.05	0.08

Note:

- Decrease both spindle speed and feed rate proportionally when the milling parameters exceed the machine's maximum spindle speed.
- Recommend oil mist to avoid tool damage.

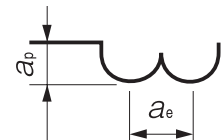

Ø3mm Shank
V Series

UDC-PCD
Series

CBN
Series

Square

Long Neck
Square

Radius

Long Neck
Radius

Taper Neck
Radius

Ball / Long
Shank Ball

Long Neck
Ball

Taper Neck
Ball

Taper

Barrel

Spiral
V Cutter

Drill

Technical Data



Size $\phi 0.2 \sim \phi 2$

CBN-RSF



Patented in Japan, Taiwan

Material Applications (★ Highly Recommended ● Recommended ○ Suggested)

Work Material																	
Carbon Steels S45C S55C	Alloy Steels SK / SCM SUS	Prehardened Steels NAK HPM	Hardened Steels					Cast Iron	Aluminum Alloys	Graphite	Copper	Plastics	Glass Filled Plastics	Titanium Alloys	Heat Resistant Alloys	Cemented Carbide	Hard Brittle (Non-Metallic) Materials
			~50HRC	~55HRC	~60HRC	~65HRC	~70HRC										
					●	●											

Label Sample



#001 $\phi D0.998 R+0.001/0.000$

Diameter and Corner R accuracy measurements are printed on the label to support High Precision milling.

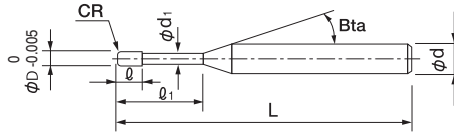

The shank taper angle shown is not an exact value and to avoid contact with the work piece, we recommend the user controls the precise value of this angle. Shank taper angle should not make contact with the work piece.

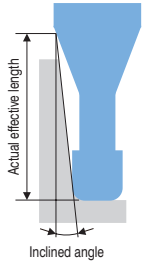

Features

The tool relief rubs against the milling surface to create a burnished finish.
1 flute design enables an even milling amount and prevents chip biting caused by runout.

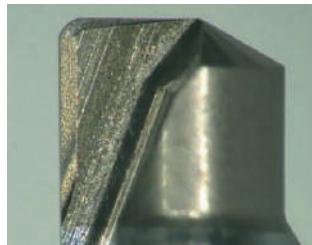

The cutting edge at the tip point has a burnishing effect. (ELMAX 60HRC)
The unique design on the tool relief offers a shiny surface finish.

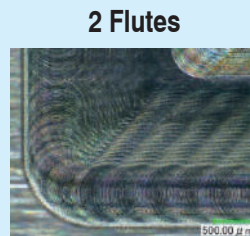
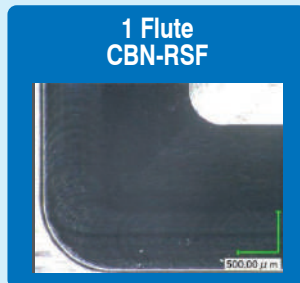

Inclined pocket milling

1 Flute CBN-RSF $\phi 2 \times CR0.1 \times EL4$

ELMAX (60HRC)

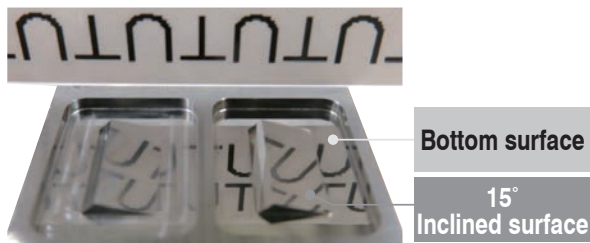

CBN-LRF
(Conventional)

CBN-RSF

Bottom surface

15°
Inclined surface

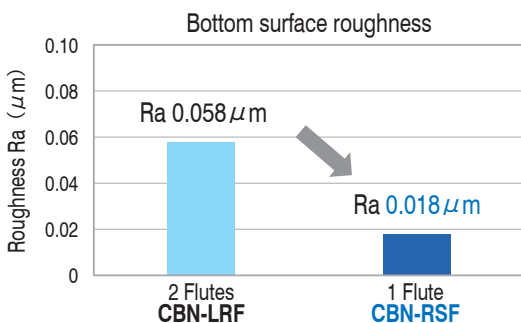

Process	Finishing
Milling Method	Contour Milling
Spindle Speed	30,000 min^{-1}
Feed Rate	375 mm/min
Finishing Allowance	0.01 mm/min
Cusp Height at Inclined Surface	0.00003 mm
Cycle Time	61 min

Improved quality for milling on the bottom, inclined and vertical surfaces as compared to conventional CBN-LRF series.

Milled Size : $9 \times 13 \times \text{Depth } 1 \text{ mm}$
Coolant : Oil Mist

Pocket milling

1 Flute CBN-RSF $\phi 2 \times CR0.1 \times EL4$

ELMAX (60HRC)

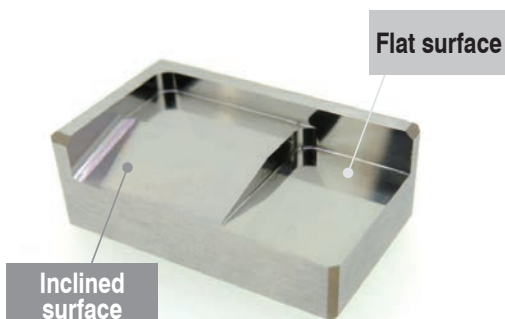

Flat surface

Inclined
surface

Work Size : $25 \times 25 \times 10 \text{ mm}$
Coolant : Oil Mist

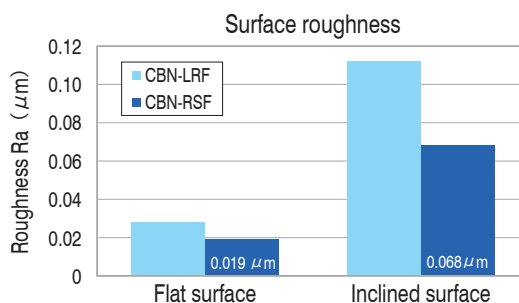

1 flute CBN-RSF gives excellent surface roughness

No.	Process	Tool	Spindle Speed (min^{-1})	Feed Rate (mm/min)	a_p (mm)	a_e (mm)	Allowance (mm)	Cycle Time (h:m:s)
1	Roughing	HGLB R1 \times EL4	14,000	2,100	0.15	0.5	0.05	0:10:17
2	Semi-finishing	HLRS $\phi 2 \times CR0.1 \times EL4$	11,500	860	0.031	0.36	0.05	1:11:50
					0.02	0.36	0.02	
					0.005	0.1	0.01	
3	Finishing	CBN-RSF $\phi 2 \times CR0.1 \times EL4$	30,000	375	0.01	0.1	0	2:25:01

Total 3:47:08

$\phi 3 \text{mm}$ Shank
V Series

UDC-PCD
Series

CBN
Series

Square

Long Neck
Square

Radius

Long Neck
Radius

Taper Neck
Radius

Ball / Long
Shank Ball

Long Neck
Ball

Taper Neck
Ball

Taper

Barrel

Spiral
V Cutter

Drill

Technical Data

1 Flute CBN Long Neck Radius End Mills for Super Finishing

Total 42 models

*Shank taper angle Bta is only for reference.

Unit (mm)

Model Number	Outside Diameter ϕD	Corner Radius CR	Effective Length ℓ_1	Length of Cut ℓ	Neck Diameter ϕd_1	Shank Taper Angle Bta	Overall Length L	Shank Diameter ϕd	Suggested Retail Price ¥	Effective Length by Inclined Angles					
										30°	1°	1°30'	2°	3°	
CBN-RSF 1002-002003	0.2	RO.02	0.3	0.08	0.19	15°	50	4	36,600	0.30	0.30	0.30	0.31	0.34	
CBN-RSF 1002-002005			0.5				50	4	36,600	0.50	0.50	0.52	0.54	0.59	
CBN-RSF 1002-005003		RO.05	0.3				50	4	32,900	0.30	0.30	0.30	0.31	0.33	
CBN-RSF 1002-005005			0.5				50	4	32,900	0.50	0.50	0.52	0.54	0.58	
CBN-RSF 1003-002005	0.3	RO.02	0.5	0.13	0.28	15°	50	4	36,200	0.51	0.53	0.55	0.57	0.62	
CBN-RSF 1003-002010			1				50	4	36,600	1.03	1.07	1.11	1.15	1.25	
CBN-RSF 1003-005005		RO.05	0.5				50	4	32,500	0.51	0.53	0.55	0.57	0.62	
CBN-RSF 1003-005010			1				50	4	32,900	1.03	1.07	1.10	1.15	1.24	
CBN-RSF 1004-002005	0.4	RO.02	0.5	0.24	0.38	15°	50	4	34,300	0.51	0.53	0.55	0.57	0.62	
CBN-RSF 1004-002015			1.5				50	4	35,000	1.54	1.59	1.65	1.71	1.86	
CBN-RSF 1004-005005		RO.05	0.5				50	4	30,900	0.51	0.53	0.55	0.57	0.62	
CBN-RSF 1004-005015			1.5				50	4	31,100	1.54	1.59	1.65	1.71	1.85	
CBN-RSF 1005-002005	0.5	RO.02	0.5	0.3	0.48	15°	50	4	28,200	0.51	0.53	0.55	0.57	0.62	
CBN-RSF 1005-002015			1.5				50	4	28,700	1.54	1.59	1.65	1.71	1.86	
CBN-RSF 1005-005005		RO.05	0.5				50	4	25,400	0.51	0.53	0.55	0.57	0.62	
CBN-RSF 1005-005015			1.5				50	4	25,800	1.54	1.59	1.65	1.71	1.85	
CBN-RSF 1006-002010	0.6	RO.02	1	0.3	0.58	15°	50	4	28,500	1.03	1.07	1.11	1.15	1.25	
CBN-RSF 1006-002015			1.5				50	4	28,700	1.54	1.59	1.65	1.71	1.86	
CBN-RSF 1006-005010		RO.05	1				50	4	25,600	1.03	1.07	1.10	1.15	1.24	
CBN-RSF 1006-005015			1.5				50	4	25,800	1.54	1.59	1.65	1.71	1.85	
CBN-RSF 1008-002010	0.8	RO.02	1	0.56	0.78	15°	50	4	28,700	1.03	1.07	1.11	1.15	1.25	
CBN-RSF 1008-002020			2				50	4	28,700	2.05	2.13	2.20	2.29	2.48	
CBN-RSF 1008-005010		RO.05	1				50	4	25,800	1.03	1.07	1.10	1.15	1.24	
CBN-RSF 1008-005020			2				50	4	25,800	2.05	2.12	2.20	2.28	2.47	
CBN-RSF 1010-002010	1	RO.02	1	0.7	0.98	15°	50	4	26,400	1.03	1.07	1.11	1.15	1.25	
CBN-RSF 1010-002020			2				50	4	26,400	2.07	2.14	2.22	2.30	2.49	
CBN-RSF 1010-002030			3				50	4	26,400	3.10	3.21	3.33	3.45	3.73	
CBN-RSF 1010-005010			1				50	4	23,700	1.03	1.07	1.11	1.15	1.24	
CBN-RSF 1010-005020		RO.05	2				50	4	23,700	2.06	2.14	2.21	2.30	2.48	
CBN-RSF 1010-005030			3				50	4	23,700	3.10	3.21	3.32	3.45	3.73	
CBN-RSF 1010-010010			1				50	4	23,700	1.03	1.06	1.10	1.14	1.23	
CBN-RSF 1010-010020			RO.1				2	50	4	23,700	2.06	2.13	2.21	2.29	2.47
CBN-RSF 1010-010030	3	50		4	23,700	3.10	3.20	3.32	3.44	3.72					
CBN-RSF 1015-002030	1.5	RO.02	3	1	1.46	15°	50	4	31,000	3.14	3.25	3.37	3.49	3.78	
CBN-RSF 1015-005030		RO.05	3				50	4	27,900	3.14	3.25	3.36	3.49	3.77	
CBN-RSF 1015-010030		RO.1	3				50	4	27,900	3.14	3.24	3.36	3.48	3.76	
CBN-RSF 1020-002040	2	RO.02	4	1.2	1.97	15°	50	4	32,000	4.15	4.30	4.45	4.62	5.00	
CBN-RSF 1020-002060			6				50	4	32,000	6.22	6.44	6.67	6.92	7.49	
CBN-RSF 1020-005040		RO.05	4				50	4	28,700	4.15	4.30	4.45	4.62	4.99	
CBN-RSF 1020-005060			6				50	4	28,700	6.22	6.44	6.67	6.92	7.48	
CBN-RSF 1020-010040			RO.1				4	50	4	28,700	4.15	4.29	4.45	4.61	4.98
CBN-RSF 1020-010060							6	50	4	28,700	6.22	6.43	6.66	6.91	7.47

- 3mm Shank V Series
- UDC-PCD Series
- CBN Series
- Square
- Long Neck Square
- Radius
- Long Neck Radius
- Taper Neck Radius
- Ball / Long Shank Ball
- Long Neck Ball
- Taper Neck Ball
- Taper
- Barrel
- Spiral V Cutter
- Drill
- Technical Data

Milling Conditions for CBN-RSF

WORK MATERIAL				HARDENED STEELS ELMAX (58~62HRC)				HARDENED STEELS HAP10 (62~65HRC)			
Model Number	Outside Diameter (mm)	Corner Radius (mm)	Effective Length (mm)	Spindle Speed (min ⁻¹)	Feed Rate (mm/min)	a_p Axial Depth (mm)	a_e Radial Depth (mm)	Spindle Speed (min ⁻¹)	Feed Rate (mm/min)	a_p Axial Depth (mm)	a_e Radial Depth (mm)
1002-002003	0.2	R0.02	0.3	60,000	80 MAX	0.003	0.01	60,000	20 MAX	0.003	0.005
1002-002005			0.5	60,000	80 MAX	0.003	0.01	60,000	20 MAX	0.003	0.005
1002-005003		R0.05	0.3	60,000	80 MAX	0.003	0.01	60,000	20 MAX	0.003	0.005
1002-005005			0.5	60,000	80 MAX	0.003	0.01	60,000	20 MAX	0.003	0.005
1003-002005	0.3	R0.02	0.5	40,000	80 MAX	0.004	0.015	40,000	20 MAX	0.004	0.005
1003-002010			1	40,000	80 MAX	0.004	0.015	40,000	20 MAX	0.004	0.005
1003-005005		R0.05	0.5	40,000	80 MAX	0.004	0.015	40,000	20 MAX	0.004	0.005
1003-005010			1	40,000	80 MAX	0.004	0.015	40,000	20 MAX	0.004	0.005
1004-002005	0.4	R0.02	0.5	30,000	80 MAX	0.005	0.02	30,000	20 MAX	0.005	0.006
1004-002015			1.5	30,000	80 MAX	0.005	0.02	30,000	20 MAX	0.005	0.006
1004-005005		R0.05	0.5	30,000	100 MAX	0.005	0.02	30,000	60 MAX	0.005	0.02
1004-005015			1.5	30,000	100 MAX	0.005	0.02	30,000	60 MAX	0.005	0.02
1005-002005	0.5	R0.02	0.5	30,000	90 MAX	0.005	0.025	30,000	25 MAX	0.005	0.008
1005-002015			1.5	30,000	90 MAX	0.005	0.025	30,000	25 MAX	0.005	0.008
1005-005005		R0.05	0.5	30,000	100 MAX	0.01	0.025	30,000	60 MAX	0.01	0.025
1005-005015			1.5	30,000	100 MAX	0.01	0.025	30,000	60 MAX	0.01	0.025
1006-002010	0.6	R0.02	1	30,000	100 MAX	0.005	0.03	30,000	30 MAX	0.005	0.01
1006-002015			1.5	30,000	100 MAX	0.005	0.03	30,000	30 MAX	0.005	0.01
1006-005010		R0.05	1	30,000	110 MAX	0.01	0.03	30,000	65 MAX	0.01	0.03
1006-005015			1.5	30,000	110 MAX	0.01	0.03	30,000	65 MAX	0.01	0.03
1008-002010	0.8	R0.02	1	30,000	125 MAX	0.005	0.04	30,000	40 MAX	0.005	0.012
1008-002020			2	30,000	125 MAX	0.005	0.04	30,000	40 MAX	0.005	0.012
1008-005010		R0.05	1	30,000	140 MAX	0.01	0.04	30,000	85 MAX	0.01	0.04
1008-005020			2	30,000	140 MAX	0.01	0.04	30,000	85 MAX	0.01	0.04
1010-002010	1	R0.02	1	30,000	150 MAX	0.005	0.05	30,000	50 MAX	0.005	0.015
1010-002020			2	30,000	150 MAX	0.005	0.05	30,000	50 MAX	0.005	0.015
1010-002030			3	30,000	150 MAX	0.005	0.05	30,000	50 MAX	0.005	0.015
1010-005010		R0.05	1	30,000	165 MAX	0.01	0.05	30,000	100 MAX	0.01	0.04
1010-005020			2	30,000	165 MAX	0.01	0.05	30,000	100 MAX	0.01	0.04
1010-005030			3	30,000	165 MAX	0.01	0.05	30,000	100 MAX	0.01	0.04
1010-010010		R0.1	1	30,000	185 MAX	0.01	0.05	30,000	150 MAX	0.01	0.05
1010-010020			2	30,000	185 MAX	0.01	0.05	30,000	150 MAX	0.01	0.05
1010-010030			3	30,000	185 MAX	0.01	0.05	30,000	150 MAX	0.01	0.05
1015-002030		1.5	R0.02	3	30,000	225 MAX	0.005	0.075	30,000	75 MAX	0.005
1015-005030	R0.05		3	30,000	250 MAX	0.01	0.075	30,000	150 MAX	0.01	0.05
1015-010030	R0.1		3	30,000	280 MAX	0.01	0.075	30,000	225 MAX	0.01	0.075
1020-002040	2	R0.02	4	30,000	300 MAX	0.005	0.1	30,000	100 MAX	0.005	0.03
1020-002060			6	30,000	300 MAX	0.005	0.1	30,000	100 MAX	0.005	0.03
1020-005040		R0.05	4	30,000	330 MAX	0.01	0.1	30,000	200 MAX	0.01	0.07
1020-005060			6	30,000	330 MAX	0.01	0.1	30,000	200 MAX	0.01	0.07
1020-010040		R0.1	4	30,000	375 MAX	0.01	0.1	30,000	300 MAX	0.01	0.1
1020-010060			6	30,000	375 MAX	0.01	0.1	30,000	300 MAX	0.01	0.1

Note:

- Decrease both spindle speed and feed rate proportionally when the milling parameters exceed the machine's maximum spindle speed.
- Recommend oil mist to avoid tool damage.

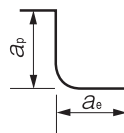

Ø3mm Shank
V Series

UDC-PCD
Series

CBN
Series

Square

Long Neck
Square

Radius

Long Neck
Radius

Taper Neck
Radius

Ball / Long
Shank Ball

Long Neck
Ball

Taper Neck
Ball

Taper

Barrel

Spiral
V Cutter

Drill

Technical Data



Size $\phi 0.1 \sim \phi 3$

CBN-LRF2000

Additional 4 models

CBN
 0°
R
 ± 0.002
 ± 0.003
Shank Dia. $0/-0.004$
Back Taper Geometry

$CR \leq 0.03$
 $CR \geq 0.05$

Material Applications (★ Highly Recommended ● Recommended ○ Suggested)

Work Material																	
Carbon Steels S45C S55C	Alloy Steels SK / SCM SUS	Prehardened Steels NAK HPM	Hardened Steels					Cast Iron	Aluminum Alloys	Graphite	Copper	Plastics	Glass Filled Plastics	Titanium Alloys	Heat Resistant Alloys	Cemented Carbide	Hard Brittle (Non-Metallic) Materials
			~50HRC	~55HRC	~60HRC	~65HRC	~70HRC										
		○	●	●	●	●	●										

Label Sample



#001 $\phi D0.997 R+0.001/0.000$

Diameter and Corner R accuracy measurements are printed on the label to support High Precision milling.

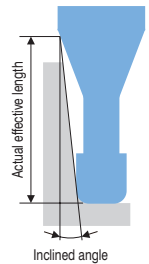
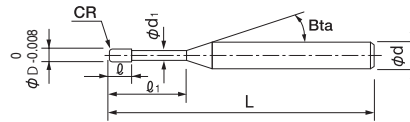

The shank taper angle shown is not an exact value and to avoid contact with the work piece, we recommend the user controls the precise value of this angle. Shank taper angle should not make contact with the work piece.

Features

Various lineup from $\phi 0.1$ to $\phi 3$

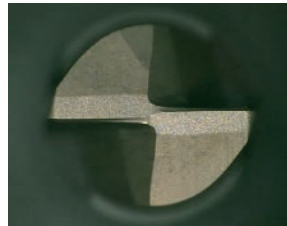

CBN-LRF2000/4000 Common features

Feature 1 High rigidity cutting edge

Super negative rake angle from the cutting edge at the tip point to peripheral cutting edge. Less damage when milling hard materials.

Feature 2 Sharp cutting edge

The cutting edge is outstandingly sharp even with the super negative rake angle.

- φ3mm Shank V Series
- UDC-PCD Series
- CBN Series
- Square
- Long Neck Square
- Radius
- Long Neck Radius
- Taper Neck Radius
- Ball / Long Shank Ball
- Long Neck Ball
- Taper Neck Ball
- Taper
- Barrel
- Spiral V Cutter
- Drill
- Technical Data

Fuel cell separator mold

2 Flutes CBN-LRF $\phi 1 \times \text{CR}0.1 \times \text{EL}1$

SKH51 (63HRC)

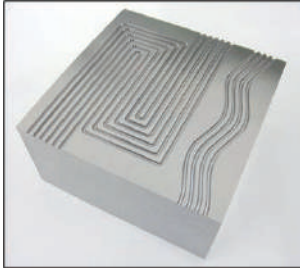

Size : 80 × 80 × 40 mm

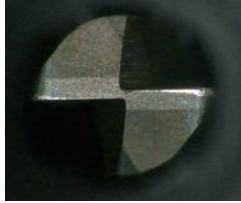
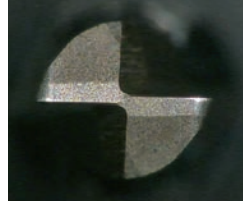
After finishing of crank shape
(Milling time 10h 23min)After finishing of wave shape
(Milling time 2h 58min)

CBN-LRF 2000



Process	Tool	Spindle Speed (min ⁻¹)	Feed Rate (mm/min)	Allowance (mm)	a_p (mm)	a_e (mm)	Coolant	Cycle Time (h:m:s)
Roughing	HLRS $\phi 1 \times \text{CR}0.3 \times \text{EL}2$	10,900	710	—	0.03	0.27	Air Blow	2:43:45
Semi-finishing	HLRS $\phi 1 \times \text{CR}0.2 \times \text{EL}2$	10,900	710	0.015	0.03	0.1		3:07:09
Finishing	CBN-LRF $\phi 1 \times \text{CR}0.1 \times \text{EL}1$	30,000	525	0.005	0.01	0.1	Oil Mist	13:21:57
Total								19:12:51

CBN bottom surface finishing

2 Flutes CBN-LRF $\phi 2 \times \text{CR}0.1 \times \text{EL}1$

STAVAX (52HRC)



Size : 60 × 35 × 20 mm

Surface roughness Ra 0.03 μm Bottom
surface
milling

CBN-LRF 2000



Process	Tool	Spindle Speed (min ⁻¹)	Feed Rate (mm/min)	a_p (mm)	a_e (mm)	Cycle Time (h:m:s)
Roughing	HRRS $\phi 6 \times \text{CR}1$	6,000	4,000	0.3	2.7	0:03:00
Semi-finishing	HRRS $\phi 6 \times \text{CR}1$	15,000	7,000	0.03	0.03	0:04:00
Semi-finishing	HSB R1.5	30,000	1,200	0.05	0.05	0:13:00
Semi-finishing	HSB R1	30,000	1,000	0.01	0.01	1:20:00
Finishing	CBN-LBSF R1	30,000	1,000	0.003	0.003	4:30:00
Semi-finishing	HLRS $\phi 2 \times \text{CR}0.1 \times \text{EL}4$	20,000	2,000	0.04	0.2	0:05:00
Semi-finishing	CBN-LRF $\phi 2 \times \text{CR}0.1 \times \text{EL}4$	20,000	1,200	0.02	0.15	0:13:00
Finishing	CBN-LRF $\phi 2 \times \text{CR}0.1 \times \text{EL}4$	25,000	1,000	0.01	0.1	0:38:00
Finishing	HSB R0.1	10,000	50	0.01	—	0:07:00
Total						7:13:00

$\phi 3\text{mm}$ Shank
V Series

UDC-PCD
Series

CBN
Series

Square

Long Neck
Square

Radius

Long Neck
Radius

Taper Neck
Radius

Ball / Long
Shank Ball

Long Neck
Ball

Taper Neck
Ball

Taper

Barrel

Spiral
V Cutter

Drill

Technical Data

Pocket milling
2 Flutes CBN-LRF $\phi 2 \times CR0.02 \times EL4$

HAP10 (65HRC)

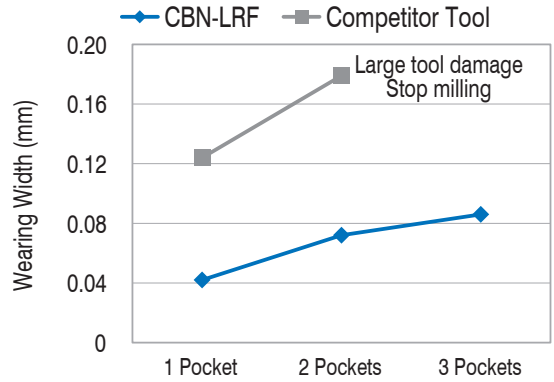
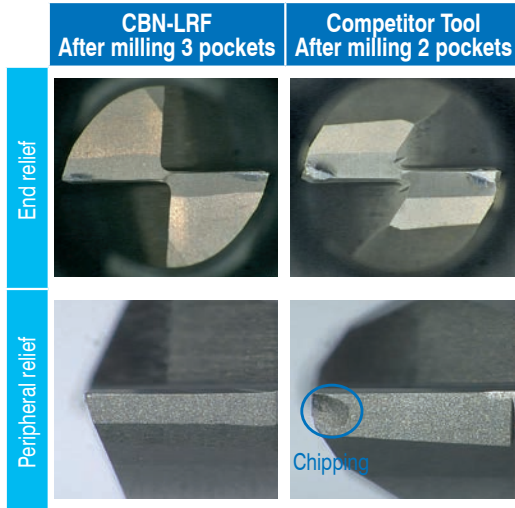

Less tool damage on 65HRC high speed steel!

Pocket Size : $15 \times 15 \times 0.3$ mm
 Coolant : Oil Mist

Tool	Spindle Speed (min ⁻¹)	Feed Rate (mm/min)	a_p (mm)	a_e (mm)	Cycle Time
CBN-LRF $\phi 2 \times CR0.02 \times EL4$	16,000	530	0.005	0.4	59 min / pocket

LED mold
2 Flutes CBN-LRF $\phi 0.4 \times CR0.02 \times EL1$

ELMAX (62HRC)

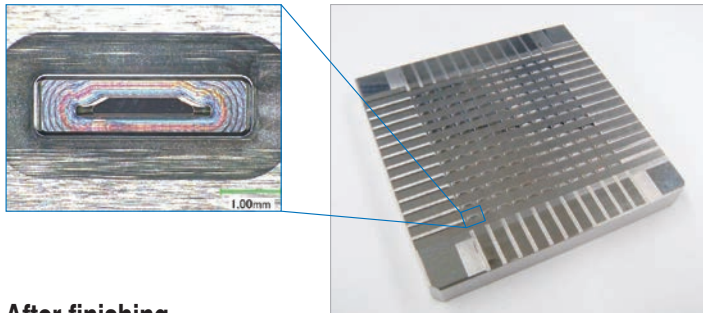

Work Size : $80 \times 80 \times 10$ mm
 Coolant : Oil Mist

After finishing

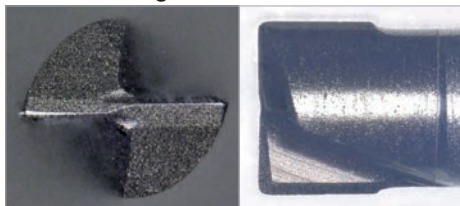

Less tool damage after 10 hours' milling!

Tool	Process	Spindle Speed (min ⁻¹)	Feed Rate (mm/min)	a_p (mm)	a_e (mm)	Cycle Time
CBN-LRF $\phi 0.4 \times CR0.02 \times EL1$	Finishing	38,000	600	0.01	0.01	10 h

Total 143 models

*Shank taper angle Bta is only for reference.

Unit (mm)

Model Number	Outside Diameter ϕD	Corner Radius CR	Effective Length l_1	Length of Cut l	Neck Diameter ϕd_1	Shank Taper Angle Bta	Overall Length L	Shank Diameter ϕd	Suggested Retail Price ¥	Effective Length by Inclined Angles				
										30°	1°	1°30'	2°	3°
CBN-LRF 2001-002002	0.1	RO.02	0.2	0.04	0.09	15°	50	4	44,500	0.20	0.20	0.20	0.20	0.21
CBN-LRF 2001-002003			0.3				50	4	45,200	0.30	0.30	0.30	0.30	0.33
CBN-LRF 2001-002005			0.5				50	4	46,500	0.50	0.50	0.51	0.53	0.58
CBN-LRF 2001-003002		RO.03	0.2				50	4	42,500	0.20	0.20	0.20	0.20	0.21
CBN-LRF 2001-003003			0.3				50	4	43,200	0.30	0.30	0.30	0.30	0.33
CBN-LRF 2001-003005			0.5				50	4	44,500	0.50	0.50	0.51	0.53	0.58
CBN-LRF 20015-002X2	0.15	RO.02	0.2	0.06	0.14	15°	50	4	44,500	0.20	0.20	0.20	0.20	0.21
CBN-LRF 20015-002X3			0.3				50	4	45,200	0.30	0.30	0.30	0.30	0.33
CBN-LRF 20015-002X5			0.5				50	4	46,500	0.50	0.50	0.51	0.53	0.58
CBN-LRF 20015-003X2		RO.03	0.2				50	4	42,500	0.20	0.20	0.20	0.20	0.21
CBN-LRF 20015-003X3			0.3				50	4	43,200	0.30	0.30	0.30	0.30	0.33
CBN-LRF 20015-003X5			0.5				50	4	44,500	0.50	0.50	0.51	0.53	0.58
CBN-LRF 2002-002005	0.2	RO.02	0.5	0.08	0.19	15°	50	4	33,900	0.50	0.50	0.51	0.53	0.58
CBN-LRF 2002-002X75			0.75				50	4	34,400	0.75	0.76	0.79	0.82	0.89
CBN-LRF 2002-002010			1				50	4	34,900	1.00	1.03	1.07	1.11	1.20
CBN-LRF 2002-003005		RO.03	0.5				50	4	30,500	0.50	0.50	0.51	0.53	0.58
CBN-LRF 2002-003X75			0.75				50	4	30,900	0.75	0.76	0.79	0.82	0.89
CBN-LRF 2002-003010			1				50	4	31,400	1.00	1.03	1.07	1.11	1.20
CBN-LRF 2002-005005	0.25	RO.05	0.5	0.1	0.24	15°	50	4	30,500	0.50	0.50	0.51	0.53	0.57
CBN-LRF 2002-005X75			0.75				50	4	30,900	0.75	0.76	0.79	0.82	0.88
CBN-LRF 2002-005010			1				50	4	31,400	1.00	1.03	1.06	1.10	1.19
CBN-LRF 20025-005X5		RO.01	0.5				50	4	33,500	0.51	0.53	0.55	0.57	0.62
CBN-LRF 20025-X5X75			0.75				50	4	33,700	0.77	0.79	0.82	0.86	0.93
CBN-LRF 20025-X5010			1				50	4	34,100	1.02	1.06	1.10	1.14	1.24
CBN-LRF 2003-001010	0.3	RO.02	0.5	0.13	0.28	15°	50	4	33,900	1.02	1.06	1.10	1.14	1.24
CBN-LRF 2003-002005			0.75				50	4	33,900	1.02	1.06	1.10	1.14	1.24
CBN-LRF 2003-002X75			1				50	4	34,400	1.54	1.60	1.65	1.72	1.86
CBN-LRF 2003-002010			1.5				50	4	34,900	2.05	2.12	2.20	2.28	2.47
CBN-LRF 2003-002015			2				50	4	30,100	0.51	0.53	0.55	0.57	0.62
CBN-LRF 2003-003005			0.75				50	4	30,300	0.77	0.79	0.82	0.85	0.93
CBN-LRF 2003-003X75		1	50				4	30,500	1.02	1.06	1.10	1.14	1.24	
CBN-LRF 2003-003010		1.5	50				4	30,900	1.54	1.60	1.65	1.72	1.86	
CBN-LRF 2003-003015		2	50				4	31,300	2.05	2.12	2.20	2.28	2.47	
CBN-LRF 2003-003020		0.5	50				4	30,100	0.51	0.52	0.54	0.56	0.61	
CBN-LRF 2003-005005		0.75	50				4	30,300	0.76	0.79	0.82	0.85	0.92	
CBN-LRF 2003-005X75		1	50				4	30,500	1.02	1.06	1.10	1.14	1.23	
CBN-LRF 2003-005010		1.5	50				4	30,900	1.54	1.59	1.65	1.71	1.85	
CBN-LRF 2003-005015		2	50				4	31,300	2.05	2.12	2.20	2.28	2.46	
CBN-LRF 2003-005020														

Next Page →

3mm Shank
V SeriesUDC-PCD
SeriesCBN
SeriesSquare
Long Neck
SquareRadius
Long Neck
RadiusTaper Neck
RadiusBall / Long
Shank BallLong Neck
BallTaper Neck
Ball

Taper

Barrel

Spiral
V Cutter

Drill

Technical Data

Model Number	Outside Diameter ϕD	Corner Radius CR	Effective Length l_1	Length of Cut l	Neck Diameter ϕd_1	Shank Taper Angle β	Overall Length L	Shank Diameter ϕd	Suggested Retail Price ¥	Effective Length by Inclined Angles								
										30°	1°	1°30'	2°	3°				
CBN-LRF 2004-002005	0.4	RO.02	0.5	0.24	0.38	15°	50	4	31,800	0.51	0.53	0.55	0.57	0.62				
CBN-LRF 2004-002010			1				50	4	32,000	1.02	1.06	1.10	1.14	1.24				
CBN-LRF 2004-002015			1.5				50	4	32,400	1.53	1.59	1.64	1.71	1.85				
CBN-LRF 2004-002020			2				50	4	32,800	2.05	2.12	2.20	2.28	2.47				
CBN-LRF 2004-003005			0.5				RO.03	1	50	4	28,600	0.51	0.53	0.55	0.57	0.62		
CBN-LRF 2004-003010		1	50					4	28,800	1.02	1.06	1.10	1.14	1.24				
CBN-LRF 2004-003015		1.5	50					4	28,800	1.53	1.59	1.64	1.71	1.85				
CBN-LRF 2004-005005		0.5	RO.05					1	50	4	28,600	0.51	0.52	0.54	0.56	0.61		
CBN-LRF 2004-005010		1						50	4	28,800	1.02	1.06	1.10	1.14	1.23			
CBN-LRF 2004-005015		1.5					50	4	28,800	1.53	1.58	1.64	1.70	1.84				
CBN-LRF 2004-005020		2					50	4	28,800	2.05	2.12	2.20	2.28	2.46				
CBN-LRF 2004-005040		4					50	4	29,800	4.11	4.26	4.41	4.58	4.95				
CBN-LRF 2004-010005		0.5	RO.1				0.5	0.3	0.48	15°	50	4	28,600	0.50	0.52	0.54	0.56	0.60
CBN-LRF 2004-010010							1				50	4	28,800	1.02	1.06	1.09	1.13	1.22
CBN-LRF 2004-010015							1.5				50	4	28,800	1.53	1.58	1.64	1.70	1.83
CBN-LRF 2005-001010	1			RO.01	1	50	4				26,400	1.02	1.06	1.10	1.14	1.24		
CBN-LRF 2005-002005	0.5				50	4	26,100				0.51	0.53	0.55	0.57	0.62			
CBN-LRF 2005-002010	1		RO.02		1	50	4				26,400	1.02	1.06	1.10	1.14	1.24		
CBN-LRF 2005-002015	1.5				50	4	26,600				1.53	1.59	1.64	1.71	1.85			
CBN-LRF 2005-002020	2				50	4	26,800				2.05	2.12	2.20	2.28	2.47			
CBN-LRF 2005-003005	0.5			RO.03	1	50	4				23,500	0.51	0.53	0.55	0.57	0.62		
CBN-LRF 2005-003010	1				50	4	23,700				1.02	1.06	1.10	1.14	1.24			
CBN-LRF 2005-003015	1.5		50		4	23,900	1.53				1.59	1.64	1.71	1.85				
CBN-LRF 2005-003020	2		50		4	24,100	2.05				2.12	2.20	2.28	2.47				
CBN-LRF 2005-005005	0.5		RO.05		1	50	4				23,500	0.51	0.52	0.54	0.56	0.61		
CBN-LRF 2005-005010	1			50	4	23,700	1.02				1.06	1.10	1.14	1.23				
CBN-LRF 2005-005015	1.5			50	4	23,900	1.53				1.58	1.64	1.70	1.84				
CBN-LRF 2005-005020	2	50		4	24,100	2.05	2.12	2.20	2.28	2.46								
CBN-LRF 2005-010005	0.5	RO.1		1	50	4	23,500	0.50	0.52	0.54	0.56	0.60						
CBN-LRF 2005-010010	1		50	4	23,700	1.02	1.06	1.09	1.13	1.22								
CBN-LRF 2005-010015	1.5		50	4	23,900	1.53	1.58	1.64	1.70	1.83								
CBN-LRF 2005-010020	2		50	4	24,100	2.05	2.12	2.19	2.27	2.45								
CBN-LRF 2006-002005	0.6		RO.02	0.5	0.3	0.58	15°	50	4	26,100	0.51	0.53	0.55	0.57	0.62			
CBN-LRF 2006-002010		1		50				4	26,400	1.02	1.06	1.10	1.14	1.24				
CBN-LRF 2006-002015		1.5		50				4	26,600	1.53	1.59	1.64	1.71	1.85				
CBN-LRF 2006-005005		0.5		RO.05				1	50	4	23,500	0.51	0.52	0.54	0.56	0.61		
CBN-LRF 2006-005010		1						50	4	23,700	1.02	1.06	1.10	1.14	1.23			
CBN-LRF 2006-005015		1.5	50					4	23,900	1.53	1.58	1.64	1.70	1.84				
CBN-LRF 2006-005030		3	50					4	26,100	3.08	3.19	3.30	3.43	3.71				
CBN-LRF 2006-010005		0.5	RO.1					1	50	4	23,500	0.50	0.52	0.54	0.56	0.60		
CBN-LRF 2006-010010		1		50				4	23,700	1.02	1.06	1.09	1.13	1.22				
CBN-LRF 2006-010015		1.5		50				4	23,900	1.53	1.58	1.64	1.70	1.83				
CBN-LRF 2008-002010		1		RO.02				1	50	4	26,600	1.02	1.06	1.10	1.14	1.24		
CBN-LRF 2008-002015		1.5						50	4	26,600	1.53	1.59	1.64	1.71	1.85			
CBN-LRF 2008-002020		2	50					4	26,600	2.05	2.12	2.20	2.28	2.47				
CBN-LRF 2008-002050		5	50					4	30,100	5.15	5.33	5.52	5.73	6.20				
CBN-LRF 2008-005010		1	RO.05					1	50	4	23,900	1.02	1.06	1.10	1.14	1.23		
CBN-LRF 2008-005015	1.5	50		4	23,900	1.53	1.58	1.64	1.70	1.84								
CBN-LRF 2008-005020	2	50		4	23,900	2.05	2.12	2.20	2.28	2.46								
CBN-LRF 2008-005050	5	50		4	27,000	5.15	5.33	5.52	5.73	6.19								
CBN-LRF 2008-010010	1	RO.1		1	50	4	23,900	1.02	1.06	1.09	1.13	1.22						
CBN-LRF 2008-010015	1.5		50	4	23,900	1.53	1.58	1.64	1.70	1.83								
CBN-LRF 2008-010020	2		50	4	23,900	2.05	2.12	2.19	2.27	2.45								
CBN-LRF 2008-010050	5		50	4	27,000	5.15	5.32	5.52	5.72	6.18								

- φ3mm Shank V Series
- UDC-PCD Series
- CBN Series
- Square
- Long Neck Square
- Radius
- Long Neck Radius
- Taper Neck Radius
- Ball / Long Shank Ball
- Long Neck Ball
- Taper Neck Ball
- Taper
- Barrel
- Spiral V Cutter
- Drill
- Technical Data

Unit (mm)

Model Number	Outside Diameter ϕD	Corner Radius CR	Effective Length ℓ_1	Length of Cut ℓ	Neck Diameter ϕd_1	Shank Taper Angle Bta	Overall Length L	Shank Diameter ϕd	Suggested Retail Price ¥	Effective Length by Inclined Angles					
										30°	1°	1°30'	2°	3°	
CBN-LRF 2010-002010	1	RO.02	1	0.7	0.98	15°	50	4	24,400	1.03	1.06	1.10	1.15	1.24	
CBN-LRF 2010-002020			2				50	4	24,400	2.06	2.13	2.21	2.30	2.48	
CBN-LRF 2010-002030			3				50	4	24,400	3.09	3.20	3.32	3.45	3.73	
CBN-LRF 2010-002050			5				50	4	27,600	5.16	5.34	5.54	5.74	6.21	
CBN-LRF 2010-005010			1				RO.05	1	50	4	21,900	1.03	1.06	1.10	1.14
CBN-LRF 2010-005020		2	50					4	21,900	2.06	2.13	2.21	2.29	2.48	
CBN-LRF 2010-005030		3	50					4	21,900	3.09	3.20	3.32	3.44	3.72	
CBN-LRF 2010-005050		5	50					4	24,800	5.16	5.34	5.53	5.74	6.21	
CBN-LRF 2010-010010		1	RO.1					1	50	4	21,900	1.02	1.06	1.09	1.13
CBN-LRF 2010-010020		2					50	4	21,900	2.06	2.13	2.20	2.28	2.47	
CBN-LRF 2010-010030		3					50	4	21,900	3.09	3.20	3.31	3.43	3.71	
CBN-LRF 2010-010050		5					50	4	24,800	5.16	5.34	5.53	5.73	6.20	
CBN-LRF 2010-020010		1	RO.2				1	50	4	21,900	1.02	1.05	1.08	1.12	1.20
CBN-LRF 2010-020020		2					50	4	21,900	2.05	2.12	2.19	2.27	2.44	
CBN-LRF 2015-002030		1.5	RO.02				3	1	1.46	15°	50	4	28,700	3.13	3.24
CBN-LRF 2015-002040	4			50	4	28,700	4.17				4.31	4.47	4.64	5.02	
CBN-LRF 2015-002060	6			50	4	28,700	6.23				6.45	6.69	6.94	7.50	
CBN-LRF 2015-005030	RO.05		3	50	4	25,800	3.13				3.24	3.36	3.48	3.77	
CBN-LRF 2015-005040			4	50	4	25,800	4.16				4.31	4.47	4.63	5.01	
CBN-LRF 2015-005060			6	50	4	25,800	6.23				6.45	6.68	6.93	7.50	
CBN-LRF 2015-010030	RO.1		3	50	4	25,800	3.13				3.24	3.35	3.48	3.76	
CBN-LRF 2015-010040			4	50	4	25,800	4.16				4.31	4.46	4.63	5.00	
CBN-LRF 2015-010060			6	50	4	25,800	6.23				6.45	6.68	6.93	7.48	
CBN-LRF 2015-030045	RO.3		4.5	50	4	25,800	4.67				4.83	4.99	5.17	5.57	
CBN-LRF 2020-002040	2	RO.02	4	1.2	1.97	15°	50	4	29,600	4.15	4.29	4.45	4.62	4.99	
CBN-LRF 2020-002060			6				50	4	29,600	6.21	6.43	6.67	6.92	7.48	
CBN-LRF 2020-002080			8				50	4	31,300	8.28	8.57	8.88	9.22	9.97	
CBN-LRF 2020-002100			10				50	4	33,000	10.35	10.71	11.10	11.52	12.45	
CBN-LRF 2020-003030		RO.03	3				50	4	26,600	3.11	3.22	3.34	3.47	3.75	
CBN-LRF 2020-005040		RO.05	4				50	4	26,600	4.15	4.29	4.45	4.61	4.99	
CBN-LRF 2020-005060			6				50	4	26,600	6.21	6.43	6.66	6.91	7.47	
CBN-LRF 2020-005080			8				50	4	28,150	8.28	8.57	8.88	9.21	9.96	
CBN-LRF 2020-005100			10				50	4	29,700	10.35	10.71	11.10	11.51	12.45	
CBN-LRF 2020-010040		RO.1	4				50	4	26,600	4.14	4.29	4.44	4.60	4.98	
CBN-LRF 2020-010060			6				50	4	26,600	6.21	6.43	6.66	6.90	7.46	
CBN-LRF 2020-010080			8				50	4	28,150	8.28	8.57	8.87	9.20	9.95	
CBN-LRF 2020-010100			10				50	4	29,700	10.35	10.70	11.09	11.50	12.43	
CBN-LRF 2020-020040		RO.2	4				50	4	26,600	4.14	4.28	4.43	4.59	4.95	
CBN-LRF 2020-020060			6				50	4	26,600	6.21	6.42	6.65	6.89	7.44	
CBN-LRF 2020-020080			8				50	4	28,150	8.28	8.56	8.86	9.19	9.92	
CBN-LRF 2020-020100			10				50	4	29,700	10.34	10.70	11.08	11.49	12.41	
CBN-LRF 2020-050040		RO.5	4				50	4	26,600	4.13	4.26	4.40	4.55	4.88	
CBN-LRF 2020-050060			6				50	4	26,600	6.20	6.40	6.61	6.85	7.37	
CBN-LRF 2020-050080			8				50	4	28,150	8.27	8.54	8.83	9.15	9.85	
CBN-LRF 2020-050100	10		50	4	29,700	10.33	10.68	11.05	11.45	12.34					
※ CBN-LRF 2030-005060	3	RO.05	6	0.7	2.94	15°	50	6	34,410	6.27	6.49	6.72	6.98	7.54	
※ CBN-LRF 2030-010060		RO.1	6				50	6	34,410	6.27	6.49	6.72	6.97	7.53	
※ CBN-LRF 2030-020060		RO.2	6				50	6	34,410	6.27	6.48	6.71	6.95	7.51	
※ CBN-LRF 2030-050060		RO.5	6				50	6	34,410	6.26	6.46	6.68	6.91	7.44	

※ Additional model

3mm Shank
V SeriesUDC-PCD
SeriesCBN
SeriesSquare
Long Neck
SquareRadius
Long Neck
RadiusTaper Neck
RadiusBall / Long
Shank BallLong Neck
BallTaper Neck
Ball

Taper

Barrel

Spiral
V Cutter

Drill

Technical Data

Milling Conditions for CBN-LRF (2 Flutes)

WORK MATERIAL				HEAT-TREATED STEELS / HARDENED STEELS STAVAX (~52HRC)				HARDENED STEELS SKD11 (~62HRC)				HARDENED STEELS HAP10 / HAP72 (~68HRC)			
Model Number	Outside Diameter (mm)	Corner Radius (mm)	Effective Length (mm)	Spindle Speed (min ⁻¹)	Feed Rate (mm/min)	a _p Axial Depth (mm)	a _e Radial Depth (mm)	Spindle Speed (min ⁻¹)	Feed Rate (mm/min)	a _p Axial Depth (mm)	a _e Radial Depth (mm)	Spindle Speed (min ⁻¹)	Feed Rate (mm/min)	a _p Axial Depth (mm)	a _e Radial Depth (mm)
2001-002002	0.1	R0.02	0.2	30,000	90	0.002	0.01	30,000	60	0.002	0.01	30,000	30	0.002	0.005
2001-002003			0.3	30,000	90	0.002	0.01	30,000	60	0.002	0.01	30,000	30	0.002	0.005
2001-002005			0.5	30,000	90	0.002	0.01	30,000	60	0.002	0.01	30,000	30	0.002	0.005
2001-003002		R0.03	0.2	30,000	90	0.002	0.01	30,000	60	0.002	0.01	30,000	30	0.002	0.005
2001-003003			0.3	30,000	90	0.002	0.01	30,000	60	0.002	0.01	30,000	30	0.002	0.005
2001-003005			0.5	30,000	90	0.002	0.01	30,000	60	0.002	0.01	30,000	30	0.002	0.005
2001-002X2	0.15	R0.02	0.2	30,000	120	0.003	0.015	30,000	90	0.003	0.015	30,000	60	0.002	0.01
2001-002X3			0.3	30,000	120	0.003	0.015	30,000	90	0.003	0.015	30,000	60	0.002	0.01
2001-002X5			0.5	30,000	120	0.003	0.015	30,000	90	0.003	0.015	30,000	60	0.002	0.01
2001-003X2		R0.03	0.2	30,000	120	0.003	0.015	30,000	90	0.003	0.015	30,000	60	0.002	0.01
2001-003X3			0.3	30,000	120	0.003	0.015	30,000	90	0.003	0.015	30,000	60	0.002	0.01
2001-003X5			0.5	30,000	120	0.003	0.015	30,000	90	0.003	0.015	30,000	60	0.002	0.01
2002-002005	0.2	R0.02	0.5	30,000	140	0.003	0.02	30,000	120	0.003	0.02	30,000	80	0.003	0.01
2002-002X75			0.75	30,000	140	0.003	0.02	30,000	120	0.003	0.02	30,000	80	0.003	0.01
2002-002010			1	30,000	140	0.003	0.02	30,000	120	0.003	0.02	30,000	80	0.003	0.01
2002-003005		R0.03	0.5	30,000	140	0.003	0.02	30,000	120	0.003	0.02	30,000	80	0.003	0.01
2002-003X75			0.75	30,000	140	0.003	0.02	30,000	120	0.003	0.02	30,000	80	0.003	0.01
2002-003010			1	30,000	140	0.003	0.02	30,000	120	0.003	0.02	30,000	80	0.003	0.01
2002-005005	R0.05	0.5	30,000	140	0.003	0.02	30,000	120	0.003	0.02	30,000	80	0.003	0.01	
2002-005X75		0.75	30,000	140	0.003	0.02	30,000	120	0.003	0.02	30,000	80	0.003	0.01	
2002-005010		1	30,000	140	0.003	0.02	30,000	120	0.003	0.02	30,000	80	0.003	0.01	
2002-005X5	0.25	R0.05	0.5	30,000	190	0.004	0.03	30,000	170	0.004	0.03	30,000	140	0.003	0.015
2002-005X75			0.75	30,000	190	0.004	0.03	30,000	170	0.004	0.03	30,000	140	0.003	0.015
2002-005010			1	30,000	190	0.004	0.03	30,000	170	0.004	0.03	30,000	140	0.003	0.015
2003-001010	0.3	R0.01	1	30,000	185	0.003	0.045	30,000	160	0.003	0.045	30,000	120	0.003	0.02
2003-002005		R0.02	0.5	30,000	185	0.003	0.045	30,000	160	0.003	0.045	30,000	120	0.003	0.02
2003-002X75			0.75	30,000	185	0.003	0.045	30,000	160	0.003	0.045	30,000	120	0.003	0.02
2003-002010			1	30,000	185	0.003	0.045	30,000	160	0.003	0.045	30,000	120	0.003	0.02
2003-002015		R0.03	1.5	30,000	185	0.003	0.045	30,000	160	0.003	0.045	30,000	120	0.003	0.02
2003-002020			2	30,000	130	0.003	0.022	30,000	110	0.003	0.022	30,000	80	0.003	0.01
2003-003005	R0.05		0.5	30,000	200	0.004	0.045	30,000	175	0.004	0.045	30,000	150	0.003	0.02
2003-003X75		0.75	30,000	200	0.004	0.045	30,000	175	0.004	0.045	30,000	150	0.003	0.02	
2003-003010		1	30,000	200	0.004	0.045	30,000	175	0.004	0.045	30,000	150	0.003	0.02	
2003-003015	0.3	R0.03	1.5	30,000	200	0.004	0.045	30,000	175	0.004	0.045	30,000	150	0.003	0.02
2003-003020			2	30,000	140	0.004	0.022	30,000	120	0.004	0.022	30,000	110	0.003	0.01
2003-005005			R0.05	0.5	30,000	240	0.005	0.045	30,000	225	0.005	0.045	30,000	210	0.004
2003-005X75		0.75		30,000	240	0.005	0.045	30,000	225	0.005	0.045	30,000	210	0.004	0.02
2003-005010		1		30,000	240	0.005	0.045	30,000	225	0.005	0.045	30,000	210	0.004	0.02
2003-005015		R0.05	1.5	30,000	240	0.005	0.045	30,000	225	0.005	0.045	30,000	210	0.004	0.02
2003-005020	2		30,000	170	0.005	0.022	30,000	160	0.005	0.022	30,000	150	0.004	0.01	

- φ3mm Shank V Series
- UDC-PCD Series
- CBN Series
- Square
- Long Neck Square
- Radius
- Long Neck Radius
- Taper Neck Radius
- Ball / Long Shank Ball
- Long Neck Ball
- Taper Neck Ball
- Taper
- Barrel
- Spiral V Cutter
- Drill
- Technical Data

Milling Conditions for CBN-LRF (2 Flutes)

WORK MATERIAL				HEAT-TREATED STEELS / HARDENED STEELS STAVAX (~52HRC)				HARDENED STEELS SKD11 (~62HRC)				HARDENED STEELS HAP10 / HAP72 (~68HRC)			
Model Number	Outside Diameter (mm)	Corner Radius (mm)	Effective Length (mm)	Spindle Speed (min ⁻¹)	Feed Rate (mm/min)	a _p Axial Depth (mm)	a _e Radial Depth (mm)	Spindle Speed (min ⁻¹)	Feed Rate (mm/min)	a _p Axial Depth (mm)	a _e Radial Depth (mm)	Spindle Speed (min ⁻¹)	Feed Rate (mm/min)	a _p Axial Depth (mm)	a _e Radial Depth (mm)
2004-002005	0.4	R0.02	0.5	30,000	230	0.005	0.065	30,000	200	0.005	0.065	30,000	160	0.004	0.02
2004-002010			1	30,000	230	0.005	0.065	30,000	200	0.005	0.065	30,000	160	0.004	0.02
2004-002015			1.5	30,000	230	0.005	0.065	30,000	200	0.005	0.065	30,000	160	0.004	0.02
2004-002020			2	30,000	230	0.005	0.065	30,000	200	0.005	0.065	30,000	160	0.004	0.02
2004-003005		R0.03	0.5	30,000	270	0.006	0.065	30,000	230	0.006	0.065	30,000	180	0.004	0.02
2004-003010			1	30,000	270	0.006	0.065	30,000	230	0.006	0.065	30,000	180	0.004	0.02
2004-003015			1.5	30,000	270	0.006	0.065	30,000	230	0.006	0.065	30,000	180	0.004	0.02
2004-005005		R0.05	0.5	30,000	340	0.01	0.065	30,000	300	0.01	0.065	30,000	220	0.005	0.02
2004-005010			1	30,000	340	0.01	0.065	30,000	300	0.01	0.065	30,000	220	0.005	0.02
2004-005015			1.5	30,000	340	0.01	0.065	30,000	300	0.01	0.065	30,000	220	0.005	0.02
2004-005020			2	30,000	340	0.01	0.065	30,000	300	0.01	0.065	30,000	220	0.005	0.02
2004-005040		R0.1	4	30,000	170	0.01	0.032	30,000	150	0.01	0.032	30,000	110	0.005	0.01
2004-010005			0.5	30,000	520	0.01	0.065	30,000	450	0.01	0.065	30,000	320	0.005	0.02
2004-010010			1	30,000	520	0.01	0.065	30,000	450	0.01	0.065	30,000	320	0.005	0.02
2004-010015			1.5	30,000	520	0.01	0.065	30,000	450	0.01	0.065	30,000	320	0.005	0.02
2005-001010		0.5	R0.01	1	30,000	280	0.003	0.09	30,000	240	0.003	0.09	30,000	200	0.003
2005-002005	R0.02		0.5	30,000	280	0.005	0.09	30,000	240	0.005	0.09	30,000	200	0.005	0.03
2005-002010			1	30,000	280	0.005	0.09	30,000	240	0.005	0.09	30,000	200	0.005	0.03
2005-002015			1.5	30,000	280	0.005	0.09	30,000	240	0.005	0.09	30,000	200	0.005	0.03
2005-002020			2	30,000	280	0.005	0.09	30,000	240	0.005	0.09	30,000	200	0.005	0.03
2005-003005	R0.03		0.5	30,000	330	0.006	0.09	30,000	280	0.006	0.09	30,000	230	0.005	0.03
2005-003010			1	30,000	330	0.006	0.09	30,000	280	0.006	0.09	30,000	230	0.005	0.03
2005-003015			1.5	30,000	330	0.006	0.09	30,000	280	0.006	0.09	30,000	230	0.005	0.03
2005-003020	R0.05		2	30,000	330	0.006	0.09	30,000	280	0.006	0.09	30,000	230	0.005	0.03
2005-005005			0.5	30,000	440	0.01	0.09	30,000	380	0.01	0.09	30,000	280	0.01	0.03
2005-005010			1	30,000	440	0.01	0.09	30,000	380	0.01	0.09	30,000	280	0.01	0.03
2005-005015			1.5	30,000	440	0.01	0.09	30,000	380	0.01	0.09	30,000	280	0.01	0.03
2005-005020	R0.1		2	30,000	440	0.01	0.09	30,000	380	0.01	0.09	30,000	280	0.01	0.03
2005-010005			0.5	30,000	700	0.02	0.09	30,000	600	0.02	0.09	30,000	410	0.01	0.03
2005-010010			1	30,000	700	0.02	0.09	30,000	600	0.02	0.09	30,000	410	0.01	0.03
2005-010015			1.5	30,000	700	0.02	0.09	30,000	600	0.02	0.09	30,000	410	0.01	0.03
2005-010020	2	30,000	700	0.02	0.09	30,000	600	0.02	0.09	30,000	410	0.01	0.03		
2006-002005	0.6	R0.02	0.5	30,000	320	0.005	0.11	30,000	270	0.005	0.11	30,000	240	0.005	0.035
2006-002010			1	30,000	320	0.005	0.11	30,000	270	0.005	0.11	30,000	240	0.005	0.035
2006-002015			1.5	30,000	320	0.005	0.11	30,000	270	0.005	0.11	30,000	240	0.005	0.035
2006-005005		R0.05	0.5	30,000	500	0.01	0.11	30,000	430	0.01	0.11	30,000	340	0.01	0.035
2006-005010			1	30,000	500	0.01	0.11	30,000	430	0.01	0.11	30,000	340	0.01	0.035
2006-005015			1.5	30,000	500	0.01	0.11	30,000	430	0.01	0.11	30,000	340	0.01	0.035
2006-005030			3	30,000	500	0.01	0.11	30,000	430	0.01	0.11	30,000	340	0.01	0.035
2006-010005		R0.1	0.5	30,000	800	0.02	0.11	30,000	675	0.02	0.11	30,000	492	0.01	0.035
2006-010010			1	30,000	800	0.02	0.11	30,000	675	0.02	0.11	30,000	492	0.01	0.035
2006-010015			1.5	30,000	800	0.02	0.11	30,000	675	0.02	0.11	30,000	492	0.01	0.035

Ø3mm Shank
V SeriesUDC-PCD
SeriesCBN
SeriesSquare
Long Neck
Square

Radius

Long Neck
Radius
Taper Neck
RadiusBall / Long
Shank Ball
Long Neck
BallTaper Neck
Ball

Taper

Barrel

Spiral
V Cutter

Drill

Technical Data

Milling Conditions for CBN-LRF (2 Flutes)

WORK MATERIAL				HEAT-TREATED STEELS / HARDENED STEELS STAVAX (~52HRC)				HARDENED STEELS SKD11 (~62HRC)				HARDENED STEELS HAP10 / HAP72 (~68HRC)				
Model Number	Outside Diameter (mm)	Corner Radius (mm)	Effective Length (mm)	Spindle Speed (min ⁻¹)	Feed Rate (mm/min)	a _p Axial Depth (mm)	a _e Radial Depth (mm)	Spindle Speed (min ⁻¹)	Feed Rate (mm/min)	a _p Axial Depth (mm)	a _e Radial Depth (mm)	Spindle Speed (min ⁻¹)	Feed Rate (mm/min)	a _p Axial Depth (mm)	a _e Radial Depth (mm)	
2008-002010	0.8	R0.02	1	30,000	410	0.005	0.16	30,000	350	0.005	0.16	30,000	320	0.005	0.04	
2008-002015			1.5	30,000	410	0.005	0.16	30,000	350	0.005	0.16	30,000	320	0.005	0.04	
2008-002020			2	30,000	410	0.005	0.16	30,000	350	0.005	0.16	30,000	320	0.005	0.04	
2008-002050			5	30,000	290	0.005	0.08	30,000	250	0.005	0.08	30,000	220	0.005	0.02	
2008-005010		R0.05	1	30,000	600	0.01	0.16	30,000	510	0.01	0.16	30,000	450	0.01	0.04	
2008-005015			1.5	30,000	600	0.01	0.16	30,000	510	0.01	0.16	30,000	450	0.01	0.04	
2008-005020			2	30,000	600	0.01	0.16	30,000	510	0.01	0.16	30,000	450	0.01	0.04	
2008-005050		5	30,000	420	0.01	0.08	30,000	360	0.01	0.08	30,000	320	0.01	0.02		
2008-010010		R0.1	1	30,000	920	0.02	0.16	30,000	790	0.02	0.16	30,000	560	0.01	0.04	
2008-010015			1.5	30,000	920	0.02	0.16	30,000	790	0.02	0.16	30,000	560	0.01	0.04	
2008-010020			2	30,000	920	0.02	0.16	30,000	790	0.02	0.16	30,000	560	0.01	0.04	
2008-010050			5	30,000	640	0.02	0.08	30,000	550	0.02	0.08	30,000	390	0.01	0.02	
2010-002010		1	R0.02	1	30,000	500	0.005	0.2	30,000	430	0.005	0.2	30,000	400	0.005	0.05
2010-002020				2	30,000	500	0.005	0.2	30,000	430	0.005	0.2	30,000	400	0.005	0.05
2010-002030				3	30,000	500	0.005	0.2	30,000	430	0.005	0.2	30,000	400	0.005	0.05
2010-002050			5	30,000	500	0.005	0.2	30,000	430	0.005	0.2	30,000	400	0.005	0.05	
2010-005010	R0.05		1	30,000	700	0.01	0.2	30,000	600	0.01	0.2	30,000	500	0.01	0.05	
2010-005020			2	30,000	700	0.01	0.2	30,000	600	0.01	0.2	30,000	500	0.01	0.05	
2010-005030			3	30,000	700	0.01	0.2	30,000	600	0.01	0.2	30,000	500	0.01	0.05	
2010-005050	5		30,000	700	0.01	0.2	30,000	600	0.01	0.2	30,000	500	0.01	0.05		
2010-010010	R0.1		1	30,000	1,000	0.02	0.2	30,000	850	0.02	0.2	30,000	600	0.01	0.05	
2010-010020			2	30,000	1,000	0.02	0.2	30,000	850	0.02	0.2	30,000	600	0.01	0.05	
2010-010030			3	30,000	1,000	0.02	0.2	30,000	850	0.02	0.2	30,000	600	0.01	0.05	
2010-010050			5	30,000	1,000	0.02	0.2	30,000	850	0.02	0.2	30,000	600	0.01	0.05	
2010-020010	R0.2		1	30,000	1,600	0.04	0.2	30,000	1,350	0.04	0.2	30,000	850	0.01	0.05	
2010-020020			2	30,000	1,600	0.04	0.2	30,000	1,350	0.04	0.2	30,000	850	0.01	0.05	
2015-002030	1.5		R0.02	3	27,000	800	0.005	0.3	27,000	680	0.005	0.3	20,000	470	0.005	0.23
2015-002040				4	27,000	800	0.005	0.3	27,000	680	0.005	0.3	20,000	470	0.005	0.23
2015-002060		6		27,000	800	0.005	0.3	27,000	680	0.005	0.3	20,000	470	0.005	0.23	
2015-005030		R0.05	3	27,000	1,200	0.01	0.3	27,000	1,000	0.01	0.3	20,000	520	0.01	0.23	
2015-005040			4	27,000	1,200	0.01	0.3	27,000	1,000	0.01	0.3	20,000	520	0.01	0.23	
2015-005060			6	27,000	1,200	0.01	0.3	27,000	1,000	0.01	0.3	20,000	520	0.01	0.23	
2015-010030		R0.1	3	27,000	1,500	0.02	0.3	27,000	1,300	0.02	0.3	20,000	600	0.01	0.23	
2015-010040			4	27,000	1,500	0.02	0.3	27,000	1,300	0.02	0.3	20,000	600	0.01	0.23	
2015-010060			6	27,000	1,500	0.02	0.3	27,000	1,300	0.02	0.3	20,000	600	0.01	0.23	
2015-030045		R0.3	4.5	27,000	1,800	0.06	0.3	27,000	1,500	0.06	0.3	25,000	930	0.01	0.23	

- 0.3mm Shank V Series
- UDC-PCD Series
- CBN Series
- Square
- Long Neck Square
- Radius
- Long Neck Radius
- Taper Neck Radius
- Ball / Long Shank Ball
- Long Neck Ball
- Taper Neck Ball
- Taper
- Barrel
- Spiral V Cutter
- Drill
- Technical Data

Milling Conditions for CBN-LRF (2 Flutes)

WORK MATERIAL				HEAT-TREATED STEELS / HARDENED STEELS STAVAX (~52HRC)				HARDENED STEELS SKD11 (~62HRC)				HARDENED STEELS HAP10 / HAP72 (~68HRC)			
Model Number	Outside Diameter (mm)	Corner Radius (mm)	Effective Length (mm)	Spindle Speed (min ⁻¹)	Feed Rate (mm/min)	a_p Axial Depth (mm)	a_e Radial Depth (mm)	Spindle Speed (min ⁻¹)	Feed Rate (mm/min)	a_p Axial Depth (mm)	a_e Radial Depth (mm)	Spindle Speed (min ⁻¹)	Feed Rate (mm/min)	a_p Axial Depth (mm)	a_e Radial Depth (mm)
2020-002040	2	R0.02	4	24,000	1,000	0.005	0.4	24,000	850	0.005	0.4	16,000	530	0.005	0.4
2020-002060			6	24,000	1,000	0.005	0.4	24,000	850	0.005	0.4	16,000	530	0.005	0.4
2020-002080			8	24,000	1,000	0.005	0.4	24,000	850	0.005	0.4	16,000	530	0.005	0.4
2020-002100			10	24,000	1,000	0.005	0.4	24,000	850	0.005	0.4	16,000	530	0.005	0.4
2020-003030		R0.03	3	24,000	1,000	0.006	0.4	24,000	850	0.006	0.4	16,000	550	0.005	0.4
2020-005040		R0.05	4	24,000	1,500	0.01	0.4	24,000	1,300	0.01	0.4	16,500	600	0.01	0.4
2020-005060			6	24,000	1,500	0.01	0.4	24,000	1,300	0.01	0.4	16,500	600	0.01	0.4
2020-005080			8	24,000	1,500	0.01	0.4	24,000	1,300	0.01	0.4	16,500	600	0.01	0.35
2020-005100			10	24,000	1,500	0.01	0.4	24,000	1,300	0.01	0.4	16,500	600	0.01	0.3
2020-010040		R0.1	4	24,000	2,000	0.02	0.4	24,000	1,700	0.02	0.4	17,000	700	0.01	0.4
2020-010060			6	24,000	2,000	0.02	0.4	24,000	1,700	0.02	0.4	17,000	700	0.01	0.4
2020-010080			8	24,000	2,000	0.02	0.4	24,000	1,700	0.02	0.4	17,000	700	0.01	0.35
2020-010100			10	24,000	2,000	0.02	0.4	24,000	1,700	0.02	0.4	17,000	700	0.01	0.3
2020-020040		R0.2	4	24,000	2,000	0.04	0.4	24,000	1,700	0.04	0.4	17,700	770	0.01	0.4
2020-020060			6	24,000	2,000	0.04	0.4	24,000	1,700	0.04	0.4	17,700	770	0.01	0.4
2020-020080			8	24,000	2,000	0.03	0.4	24,000	1,700	0.03	0.4	17,700	770	0.01	0.35
2020-020100			10	24,000	2,000	0.025	0.4	24,000	1,700	0.025	0.4	17,700	770	0.01	0.3
2020-050040		R0.5	4	24,000	2,000	0.1	0.4	24,000	1,700	0.1	0.4	20,000	1,000	0.01	0.4
2020-050060			6	24,000	2,000	0.1	0.4	24,000	1,700	0.1	0.4	20,000	1,000	0.01	0.4
2020-050080			8	24,000	2,000	0.075	0.4	24,000	1,700	0.075	0.4	20,000	1,000	0.01	0.35
2020-050100	10		24,000	2,000	0.05	0.4	24,000	1,700	0.05	0.4	20,000	1,000	0.01	0.3	
2030-005060	3	R0.05	6	20,000	1,500	0.02	0.6	20,000	1,300	0.02	0.6	13,500	600	0.015	0.6
2030-010060		R0.1	6	20,000	2,000	0.04	0.6	20,000	1,700	0.04	0.6	14,000	700	0.02	0.6
2030-020060		R0.2	6	20,000	2,000	0.06	0.6	20,000	1,700	0.06	0.6	14,500	770	0.02	0.6
2030-050060		R0.5	6	20,000	2,000	0.12	0.6	20,000	1,700	0.12	0.6	16,500	1,000	0.02	0.6

Note:

- Decrease both spindle speed and feed rate proportionally when the milling parameters exceed the machine's maximum spindle speed.
- Recommend oil mist to avoid tool damage.

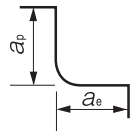

Ø3mm Shank
V Series

UDC-PCD
Series

CBN
Series

Square
Long Neck
Square

Radius
Long Neck
Radius

Taper Neck
Radius

Ball / Long
Shank Ball

Long Neck
Ball

Taper Neck
Ball

Taper

Barrel

Spiral
V Cutter

Drill

Technical Data



Size $\phi 0.1 \sim \phi 2$

CBN-LRF4000

NEW



Material Applications (★ Highly Recommended ● Recommended ○ Suggested)

Work Material																	
Carbon Steels S45C S55C	Alloy Steels SK / SCM SUS	Prehardened Steels NAK HPM	Hardened Steels					Cast Iron	Aluminum Alloys	Graphite	Copper	Plastics	Glass Filled Plastics	Titanium Alloys	Heat Resistant Alloys	Cemented Carbide	Hard Brittle (Non-Metallic) Materials
			~50HRC	~55HRC	~60HRC	~65HRC	~70HRC										
		○	●	●	●	●	●										

Label Sample



#001 $\phi D1.999 R+0.001/0.000$

Diameter and Corner R accuracy measurements are printed on the label to support High Precision milling.

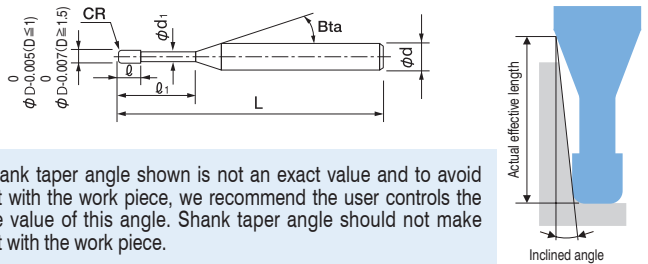

The shank taper angle shown is not an exact value and to avoid contact with the work piece, we recommend the user controls the precise value of this angle. Shank taper angle should not make contact with the work piece.

Features

4-flute shape withstands high efficiency milling.
Milling time can be significantly reduced compared to 2-flute.

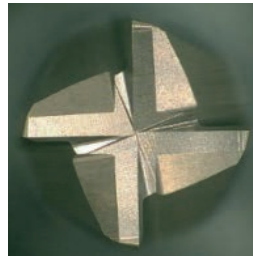

CBN-LRF2000/4000 Common features

Feature 1 High rigidity cutting edge

Super negative rake angle from the cutting edge to peripheral cutting edge.
Less damage when milling hard materials.

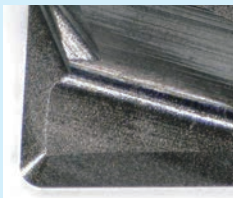

Feature 2 Sharp cutting edge

The cutting edge is outstandingly sharp even with the super negative rake angle.

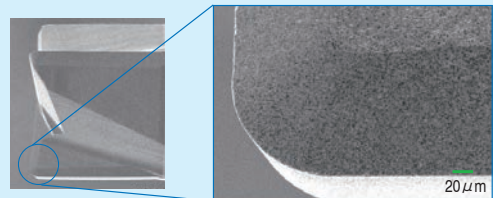

Pocket milling
2 Flutes / 4 Flutes CBN-LRF $\phi 2 \times \text{CR}0.1 \times \text{EL}6$

STAVAX (52HRC)

Tool	Flutes	Spindle Speed (min ⁻¹)	Feed Rate (mm/min)	a_p (mm)	a_e (mm)	Feed per tooth (mm/t)	Cycle Time
CBN-LRF $\phi 2 \times \text{CR}0.1 \times \text{EL}6$	4	28,000	3,300	0.05	0.7	0.029	45 min / 1 pocket
CBN-LRF $\phi 2 \times \text{CR}0.1 \times \text{EL}6$	2	28,000	3,300	0.05	0.7	0.059	45 min / 1 pocket
CBN-LRF $\phi 2 \times \text{CR}0.1 \times \text{EL}6$	2	28,000	1,650	0.05	0.7	0.029	85 min / 1 pocket

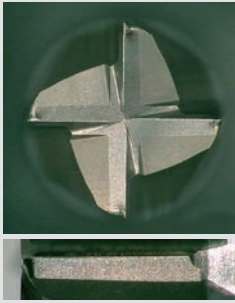
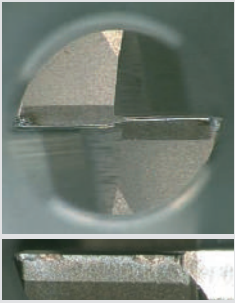
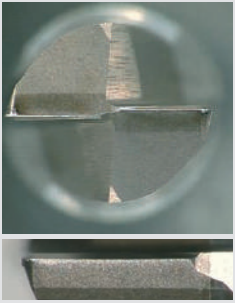
Tool	4 Flutes	2 Flutes	2 Flutes
Feed rate (mm/min)	3,300	3,300	1,650
Cycle time	135 min	135 min	255 min
Tool photo			
Milling results	Mill under higher efficiency conditions than 2-flute. Greatly shortens milling time.	Large damage under the same milling conditions as 4-flute.	When the feed per tooth is the same, the damage is small, but the milling time is about twice as long.

Pocket Size: 50 × 40 × 2 mm Coolant: Oil mist

Surface roughness by different milling conditions
4 Flutes CBN-LRF $\phi 0.3 \times \text{CR}0.05 \times \text{EL}0.5$

STAVAX (52HRC)

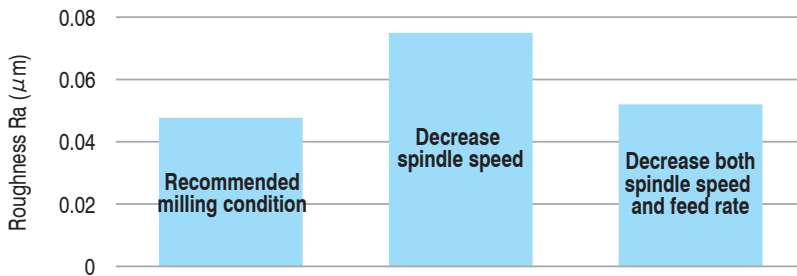

Spindle speed (min ⁻¹)	60,000	30,000	30,000
Feed rate (mm/min)	950	950	475
Cycle Time	26 min / Pocket	26 min / Pocket	50 min / Pocket

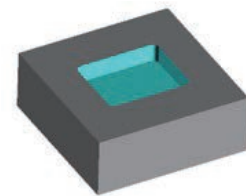

Pocket Size
 10 × 4 × 0.2 mm
 Coolant: Oil mist
 a_p : 0.005 mm
 a_e : 0.08 mm

Achieves high-speed milling that exceeds conventional CBN end mills even for small diameters.
 $\phi 0.3$ can be used in a machining center equipped with a 30,000 min⁻¹ spindle. It is recommended to decrease both spindle speed and feed rate proportionally.

4 Flutes

$\phi 3$ mm Shank
 V Series

UDC-PCD
 Series

CBN
 Series

Square
 Long Neck
 Square

Radius

Long Neck
 Radius

Taper Neck
 Radius

Ball / Long
 Shank Ball

Long Neck
 Ball

Taper Neck
 Ball

Taper

Barrel

Spiral
 V Cutter

Drill

Technical Data

4 Flutes CBN Long Neck Radius End Mills

Total 62 models

*Shank taper angle Bta is only for reference.

Unit (mm)

Model Number	Outside Diameter ϕD	Corner Radius CR	Effective Length l_1	Length of Cut l	Neck Diameter ϕd_1	Shank Taper Angle Bta	Overall Length L	Shank Diameter ϕd	Suggested Retail Price ¥	Effective Length by Inclined Angles				
										30°	1°	1°30'	2°	3°
CBN-LRF 4001-002002	0.1	RO.02	0.2	0.04	0.09	15°	50	4	49,200	0.22	0.23	0.25	0.26	0.28
CBN-LRF 4001-002003			0.3							0.33	0.34	0.36	0.37	0.40
CBN-LRF 4001-002005			0.5							0.54	0.56	0.58	0.60	0.65
CBN-LRF 40015-002X2	0.15	RO.02	0.2	0.06	0.14	15°	50	4	49,200	0.22	0.23	0.25	0.26	0.28
CBN-LRF 40015-002X3			0.3							0.33	0.34	0.36	0.37	0.40
CBN-LRF 40015-002X5			0.5							0.54	0.56	0.58	0.60	0.65
CBN-LRF 4002-002005	0.2	RO.02	0.5	0.08	0.19	15°	50	4	40,000	0.54	0.56	0.58	0.60	0.65
CBN-LRF 4002-002X75			0.75							0.80	0.82	0.86	0.89	0.96
CBN-LRF 4002-002010			1							1.05	1.09	1.13	1.18	1.27
CBN-LRF 4002-005005		RO.05	0.5							0.50	0.55	0.57	0.60	0.65
CBN-LRF 4002-005X75			0.75							0.79	0.82	0.85	0.88	0.96
CBN-LRF 4002-005010			1							1.05	1.09	1.13	1.17	1.27
CBN-LRF 4003-002X75	0.3	RO.02	0.75	0.13	0.28	15°	50	4	40,520	0.83	0.86	0.89	0.92	1.00
CBN-LRF 4003-002010			1							1.08	1.12	1.17	1.21	1.31
CBN-LRF 4003-005005		RO.05	0.5							0.57	0.59	0.61	0.63	0.68
CBN-LRF 4004-002015	0.4	RO.02	1.5	0.24	0.38	15°	50	4	38,880	1.54	1.59	1.65	1.71	1.86
CBN-LRF 4004-003005		RO.03	0.5							0.51	0.53	0.55	0.57	0.62
CBN-LRF 4004-005005		RO.05	0.5							0.51	0.53	0.55	0.57	0.62
CBN-LRF 4004-005015			1.5							1.54	1.59	1.65	1.71	1.85
CBN-LRF 4004-010005			0.5							0.51	0.53	0.54	0.56	0.61
CBN-LRF 4004-010010		RO.1	1							1.03	1.06	1.10	1.14	1.23
CBN-LRF 4005-002010		0.5	RO.02							1	0.3	0.48	15°	50
CBN-LRF 4005-005005	0.5			0.51	0.53	0.55	0.57	0.62						
CBN-LRF 4005-005010	RO.05			1	1.03	1.07	1.10	1.15	1.24					
CBN-LRF 4005-005015			1.5	1.54	1.59	1.65	1.71	1.85						
CBN-LRF 4005-010005			RO.1	0.5	0.51	0.53	0.54	0.56	0.61					
CBN-LRF 4005-010015	1.5			1.53	1.59	1.64	1.70	1.84						
CBN-LRF 4005-015005	RO.15			0.5	0.51	0.52	0.54	0.56	0.59					
CBN-LRF 4005-015015			1.5	1.53	1.58	1.64	1.69	1.83						
CBN-LRF 4006-005005			RO.05	0.5	0.51	0.53	0.55	0.57	0.62					
CBN-LRF 4006-010005	0.6	RO.1	0.5	0.3	0.58	15°	50	4	28,200	0.51	0.53	0.54	0.56	0.61
CBN-LRF 4006-010010			1							1.03	1.06	1.10	1.14	1.23

Next Page ➔

- $\phi 3mm$ Shank V Series
- UDC-PCD Series
- CBN Series
- Square
- Long Neck Square
- Radius
- Long Neck Radius
- Taper Neck Radius
- Ball / Long Shank Ball
- Long Neck Ball
- Taper Neck Ball
- Taper
- Barrel
- Spiral V Cutter
- Drill
- Technical Data

Unit (mm)

Model Number	Outside Diameter ϕD	Corner Radius CR	Effective Length l_1	Length of Cut l	Neck Diameter ϕd_1	Shank Taper Angle Bta	Overall Length L	Shank Diameter ϕd	Suggested Retail Price ¥	Effective Length by Inclined Angles								
										30°	1°	1°30'	2°	3°				
CBN-LRF 4008-005010	0.8	RO.05	1	0.56	0.78	15°	50	4	28,680	1.03	1.07	1.10	1.15	1.24				
CBN-LRF 4008-010010			1				50	4	28,680	1.03	1.06	1.10	1.14	1.23				
CBN-LRF 4008-010020		RO.1	2				50	4	28,680	2.05	2.12	2.20	2.28	2.46				
CBN-LRF 4008-010050			5				50	4	32,520	5.15	5.33	5.52	5.73	6.19				
CBN-LRF 4008-020010		RO.2	1				50	4	28,680	1.02	1.05	1.09	1.12	1.20				
CBN-LRF 4010-002010	1	RO.02	1	0.7	0.98	15°	50	4	29,300	1.03	1.07	1.11	1.15	1.25				
CBN-LRF 4010-002030			3				50	4	29,300	3.10	3.21	3.33	3.45	3.73				
CBN-LRF 4010-005010		RO.05	1				50	4	26,420	1.03	1.07	1.11	1.15	1.24				
CBN-LRF 4010-005020			2				50	4	26,420	2.06	2.14	2.21	2.30	2.48				
CBN-LRF 4010-010010		RO.1	1				50	4	26,420	1.03	1.06	1.10	1.14	1.23				
CBN-LRF 4010-010020			2				50	4	26,420	2.06	2.13	2.21	2.29	2.47				
CBN-LRF 4010-010030			3				50	4	26,420	3.10	3.20	3.32	3.44	3.72				
CBN-LRF 4010-020020		RO.2	2				50	4	26,420	2.06	2.13	2.20	2.28	2.45				
CBN-LRF 4015-002030		1.5	RO.02				3	1	1.46	15°	50	4	34,520	3.13	3.24	3.36	3.49	3.78
CBN-LRF 4015-010030			RO.1				3				50	4	31,080	3.13	3.24	3.35	3.48	3.76
CBN-LRF 4015-030030	RO.3		3	50	4	31,080	3.12				3.23	3.33	3.45	3.71				
CBN-LRF 4015-050030	RO.5		3	50	4	31,080	3.12				3.21	3.31	3.42	3.66				
CBN-LRF 4020-002040	2	RO.02	4	1.2	1.97	15°	50	4	35,630	4.15	4.29	4.45	4.62	5.00				
CBN-LRF 4020-002060			6				50	4	35,630	6.22	6.43	6.67	6.92	7.48				
CBN-LRF 4020-002100			10				50	4	38,650	10.35	10.71	11.10	11.52	12.46				
CBN-LRF 4020-005060		RO.05	6				50	4	31,970	6.21	6.43	6.66	6.91	7.48				
CBN-LRF 4020-005100			10				50	4	34,800	10.35	10.71	11.10	11.51	12.45				
CBN-LRF 4020-010040		RO.1	4				50	4	31,970	4.15	4.29	4.44	4.61	4.98				
CBN-LRF 4020-010060			6				50	4	31,970	6.21	6.43	6.66	6.91	7.46				
CBN-LRF 4020-010100		10	50				4	34,800	10.35	10.71	11.09	11.51	12.44					
CBN-LRF 4020-020040		RO.2	4				50	4	31,970	4.14	4.28	4.43	4.59	4.95				
CBN-LRF 4020-020060			6				50	4	31,970	6.21	6.42	6.65	6.89	7.44				
CBN-LRF 4020-020100		10	50				4	34,800	10.34	10.70	11.08	11.49	12.41					
CBN-LRF 4020-050060		RO.5	6				50	4	31,970	6.20	6.40	6.62	6.85	7.37				
CBN-LRF 4020-050100			10				50	4	34,800	10.33	10.68	11.05	11.45	12.34				

4 Flutes

3mm Shank
V SeriesUDC-PCD
SeriesCBN
Series

Square

Square

Long Neck
Square

Radius

Radius

Taper Neck
RadiusBall / Long
Shank Ball

Ball

Long Neck
BallTaper Neck
Ball

Taper

Taper

Barrel

Spiral
V Cutter

Drill

Technical Data

Milling Conditions for CBN-LRF (4 Flutes)

WORK MATERIAL				HEAT-TREATED STEELS / HARDENED STEELS STAVAX (~52HRC)				HARDENED STEELS SKD11 (~62HRC)				HARDENED STEELS HAP10 / HAP72 (~70HRC)			
Model Number	Outside Diameter (mm)	Corner Radius (mm)	Effective Length (mm)	Spindle Speed (min ⁻¹)	Feed Rate (mm/min)	a _p Axial Depth (mm)	a _e Radial Depth (mm)	Spindle Speed (min ⁻¹)	Feed Rate (mm/min)	a _p Axial Depth (mm)	a _e Radial Depth (mm)	Spindle Speed (min ⁻¹)	Feed Rate (mm/min)	a _p Axial Depth (mm)	a _e Radial Depth (mm)
4001-002002	0.1	R0.02	0.2	60,000	360	0.002	0.02	55,000	280	0.002	0.015	50,000	200	0.002	0.01
4001-002003			0.3	60,000	360	0.002	0.02	55,000	280	0.002	0.015	50,000	200	0.002	0.01
4001-002005			0.5	60,000	360	0.002	0.02	55,000	280	0.002	0.015	50,000	200	0.002	0.01
40015-002X2	0.15	R0.02	0.2	60,000	480	0.003	0.03	55,000	340	0.003	0.025	50,000	250	0.002	0.015
40015-002X3			0.3	60,000	480	0.003	0.03	55,000	340	0.003	0.025	50,000	250	0.002	0.015
40015-002X5			0.5	60,000	480	0.003	0.03	55,000	340	0.003	0.025	50,000	250	0.002	0.015
4002-002005	0.2	R0.02	0.5	60,000	560	0.003	0.04	55,000	430	0.003	0.03	50,000	300	0.003	0.02
4002-002X75			0.75	60,000	560	0.003	0.04	55,000	430	0.003	0.03	50,000	300	0.003	0.02
4002-002010			1	60,000	560	0.003	0.04	55,000	430	0.003	0.03	50,000	300	0.003	0.02
4002-005005		R0.05	0.5	60,000	700	0.003	0.04	55,000	550	0.003	0.03	50,000	410	0.003	0.02
4002-005X75			0.75	60,000	700	0.003	0.04	55,000	550	0.003	0.03	50,000	410	0.003	0.02
4002-005010		1	60,000	700	0.003	0.04	55,000	550	0.003	0.03	50,000	410	0.003	0.02	
4003-002X75	0.3	R0.02	0.75	60,000	750	0.003	0.08	55,000	580	0.003	0.06	50,000	400	0.003	0.03
4003-002010			1	60,000	750	0.003	0.08	55,000	580	0.003	0.06	50,000	400	0.003	0.03
4003-005005		R0.05	0.5	60,000	950	0.005	0.08	55,000	750	0.005	0.06	50,000	550	0.004	0.03
4004-002015	0.4	R0.02	1.5	55,000	850	0.005	0.1	53,000	700	0.005	0.08	50,000	550	0.004	0.05
4004-003005		R0.03	0.5	55,000	1,000	0.006	0.1	53,000	800	0.006	0.08	50,000	600	0.004	0.05
4004-005005		R0.05	0.5	55,000	1,200	0.01	0.1	53,000	1,000	0.01	0.08	50,000	730	0.007	0.05
4004-005015			1.5	55,000	1,200	0.01	0.1	53,000	1,000	0.01	0.08	50,000	730	0.007	0.05
4004-010005		R0.1	0.5	55,000	1,500	0.01	0.1	53,000	1,300	0.01	0.08	50,000	1,000	0.008	0.05
4004-010010			1	55,000	1,500	0.01	0.1	53,000	1,300	0.01	0.08	50,000	1,000	0.008	0.05
4005-002010		0.5	R0.02	1	50,000	950	0.005	0.15	50,000	900	0.005	0.12	50,000	700	0.005
4005-005005	R0.05		0.5	50,000	1,500	0.01	0.15	50,000	1,300	0.01	0.12	50,000	1,000	0.01	0.08
4005-005010			1	50,000	1,500	0.01	0.15	50,000	1,300	0.01	0.12	50,000	1,000	0.01	0.08
4005-005015			1.5	50,000	1,500	0.01	0.15	50,000	1,300	0.01	0.12	50,000	1,000	0.01	0.08
4005-010005	R0.1		0.5	50,000	1,900	0.02	0.15	50,000	1,700	0.02	0.12	50,000	1,400	0.01	0.08
4005-010015			1.5	50,000	1,900	0.02	0.15	50,000	1,700	0.02	0.12	50,000	1,400	0.01	0.08
4005-015005	R0.15		0.5	50,000	2,200	0.03	0.15	50,000	2,000	0.03	0.12	50,000	1,800	0.01	0.08
4005-015015			1.5	50,000	2,200	0.03	0.15	50,000	2,000	0.03	0.12	50,000	1,800	0.01	0.08
4006-005005	0.6		R0.05	0.5	50,000	1,700	0.01	0.2	50,000	1,500	0.01	0.15	50,000	1,200	0.01
4006-010005		R0.1	0.5	50,000	2,300	0.02	0.2	50,000	2,000	0.02	0.15	50,000	1,700	0.012	0.1
4006-010010			1	50,000	2,300	0.02	0.2	50,000	2,000	0.02	0.15	50,000	1,700	0.012	0.1

φ3mm Shank V Series

UDC-PCD Series

CBN Series

Square
Long Neck Square

Radius

Long Neck Radius
Taper Neck Radius

Ball / Long Shank Ball

Long Neck Ball
Taper Neck Ball

Taper

Barrel

Spiral V Cutter

Drill

Technical Data

Milling Conditions for CBN-LRF (4 Flutes)

WORK MATERIAL				HEAT-TREATED STEELS / HARDENED STEELS STAVAX (~52HRC)				HARDENED STEELS SKD11 (~62HRC)				HARDENED STEELS HAP10 / HAP72 (~70HRC)				
Model Number	Outside Diameter (mm)	Corner Radius (mm)	Effective Length (mm)	Spindle Speed (min ⁻¹)	Feed Rate (mm/min)	a _p Axial Depth (mm)	a _e Radial Depth (mm)	Spindle Speed (min ⁻¹)	Feed Rate (mm/min)	a _p Axial Depth (mm)	a _e Radial Depth (mm)	Spindle Speed (min ⁻¹)	Feed Rate (mm/min)	a _p Axial Depth (mm)	a _e Radial Depth (mm)	
4008-005010	0.8	R0.05	1	45,000	1,800	0.01	0.28	44,000	1,600	0.01	0.21	42,000	1,300	0.01	0.13	
4008-010010		R0.1	1	45,000	2,400	0.02	0.28	44,000	2,000	0.02	0.21	42,000	1,600	0.015	0.13	
4008-010020			2	45,000	2,400	0.02	0.28	44,000	2,000	0.02	0.21	42,000	1,600	0.015	0.13	
4008-010050			5	45,000	1,700	0.02	0.14	44,000	1,400	0.02	0.11	42,000	1,100	0.015	0.07	
4008-020010		R0.2	1	45,000	2,400	0.04	0.28	44,000	2,100	0.04	0.21	42,000	1,800	0.015	0.13	
4010-002010	1	R0.02	1	40,000	1,300	0.006	0.35	37,000	1,100	0.006	0.3	34,000	900	0.005	0.2	
4010-002030			3	40,000	1,300	0.006	0.35	37,000	1,100	0.006	0.3	34,000	900	0.005	0.2	
4010-005010		R0.05	1	40,000	1,900	0.015	0.35	37,000	1,600	0.015	0.3	34,000	1,200	0.01	0.2	
4010-005020			2	40,000	1,900	0.015	0.35	37,000	1,600	0.015	0.3	34,000	1,200	0.01	0.2	
4010-010010		R0.1	1	40,000	2,600	0.03	0.35	37,000	2,000	0.03	0.3	34,000	1,400	0.015	0.2	
4010-010020			2	40,000	2,600	0.03	0.35	37,000	2,000	0.03	0.3	34,000	1,400	0.015	0.2	
4010-010030			3	40,000	2,600	0.03	0.35	37,000	2,000	0.03	0.3	34,000	1,400	0.015	0.2	
4010-020020		R0.2	2	40,000	2,600	0.05	0.35	37,000	2,200	0.05	0.3	34,000	1,800	0.015	0.2	
4015-002030		1.5	R0.02	3	30,000	1,500	0.01	0.55	27,000	1,300	0.01	0.5	23,000	1,100	0.005	0.3
4015-010030			R0.1	3	30,000	3,000	0.05	0.55	27,000	2,200	0.05	0.5	23,000	1,400	0.02	0.3
4015-030030	R0.3		3	30,000	3,000	0.07	0.55	27,000	2,400	0.07	0.5	23,000	1,700	0.02	0.3	
4015-050030	R0.5		3	30,000	3,000	0.1	0.45	27,000	2,500	0.1	0.4	23,000	2,000	0.02	0.3	
4020-002040	2	R0.02	4	28,000	1,700	0.01	0.7	23,000	1,500	0.01	0.6	18,000	1,200	0.005	0.4	
4020-002060			6	28,000	1,700	0.01	0.7	23,000	1,500	0.01	0.6	18,000	1,200	0.005	0.4	
4020-002100			10	28,000	1,700	0.01	0.7	23,000	1,500	0.01	0.6	18,000	1,200	0.005	0.4	
4020-005060		R0.05	6	28,000	2,500	0.025	0.7	23,000	1,900	0.025	0.6	18,000	1,300	0.015	0.4	
4020-005100			10	28,000	2,500	0.025	0.7	23,000	1,900	0.025	0.6	18,000	1,300	0.015	0.4	
4020-010040		R0.1	4	28,000	3,300	0.05	0.7	23,000	2,400	0.05	0.6	18,000	1,500	0.03	0.4	
4020-010060			6	28,000	3,300	0.05	0.7	23,000	2,400	0.05	0.6	18,000	1,500	0.03	0.4	
4020-010100			10	28,000	3,300	0.05	0.7	23,000	2,400	0.05	0.6	18,000	1,500	0.03	0.4	
4020-020040		R0.2	4	28,000	3,300	0.07	0.7	23,000	2,500	0.07	0.6	18,000	1,600	0.03	0.4	
4020-020060			6	28,000	3,300	0.07	0.7	23,000	2,500	0.07	0.6	18,000	1,600	0.03	0.4	
4020-020100			10	28,000	3,300	0.07	0.7	23,000	2,500	0.07	0.6	18,000	1,600	0.03	0.4	
4020-050060		R0.5	6	28,000	3,300	0.1	0.7	23,000	2,600	0.1	0.6	18,000	1,800	0.03	0.4	
4020-050100			10	28,000	3,300	0.1	0.7	23,000	2,600	0.1	0.6	18,000	1,800	0.03	0.4	

Note:

- Decrease both spindle speed and feed rate proportionally when the milling parameters exceed the machine's maximum spindle speed.
- Recommend oil mist to avoid tool damage.

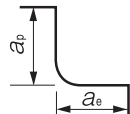

4 Flutes

- φ3mm Shank V Series
- UDC-PCD Series
- CBN Series**
- Square
- Long Neck Square
- Radius
- Long Neck Radius
- Taper Neck Radius
- Ball / Long Shank Ball
- Long Neck Ball
- Taper Neck Ball
- Taper
- Barrel
- Spiral V Cutter
- Drill
- Technical Data



Size $\phi 0.1 \sim \phi 12$

CSS

Super MG

UT COAT

30°

40°

Flatland

Shank Dia 0/-0.005

*1 Helix angle 30°: $\phi D < 0.6, 1 \leq \phi D$ (length of cut 2.5D~3D)
 *2 Helix angle 40°: $0.6 \leq \phi D < 1, 1 \leq \phi D$ (length of cut 1D~2D)

Material Applications (★ Highly Recommended ● Recommended ○ Suggested)

Work Material																	
Carbon Steels S45C S55C	Alloy Steels SK / SCM SUS	Prehardened Steels NAK HPM	Hardened Steels					Cast Iron	Aluminum Alloys	Graphite	Copper	Plastics	Glass Filled Plastics	Titanium Alloys	Heat Resistant Alloys	Cemented Carbide	Hard Brittle (Non-Metallic) Materials
			~50HRC	~55HRC	~60HRC	~65HRC	~70HRC										
●	●	●	●	●				○	○		●			○	○		

φ3mm Shank V Series

UDC-PCD Series

CBN Series

Square

Long Neck Square

Radius

Long Neck Radius

Taper Neck Radius

Ball / Long Shank Ball

Long Neck Ball

Taper Neck Ball

Taper

Barrel

Spiral V Cutter

Drill

Technical Data

Unique Cross Section design

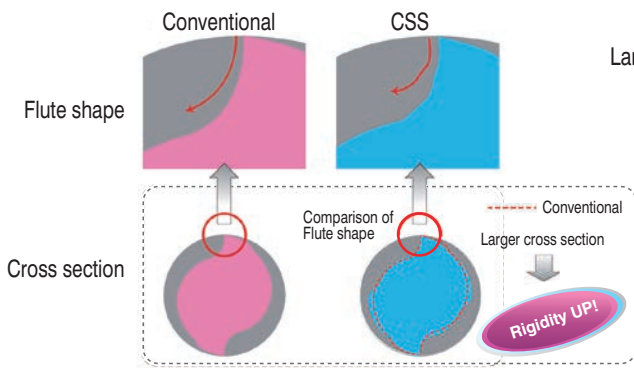

New flute shape → Higher rigidity and better chip evacuation
 Larger cross section → More resistance to breakage and wearing

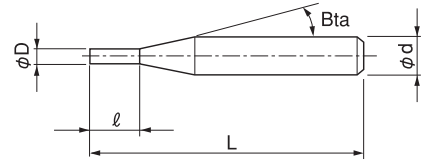

The shank taper angle shown is not an exact value and to avoid contact with the work piece, we recommend the user controls the precise value of this angle. Shank taper angle should not make contact with the work piece.

Total 112 models

Unit (mm)

Model Number	Outside Diameter ϕD	Length of Cut ℓ	Shank Taper Angle Bta	Overall Length L	Shank Diameter ϕd	Suggested Retail Price ¥
CSS 2001-0010	0.1	0.1	16°	45	4	7,800
CSS 2001-0015		0.15		45	4	7,800
CSS 2001-0020		0.2		45	4	7,800
CSS 2001-0025		0.25		45	4	7,800
CSS 2001-0030		0.3		45	4	7,800
CSS 2002-0020	0.2	0.2	16°	45	4	4,680
CSS 2002-0030		0.3		45	4	4,680
CSS 2002-0040-3		0.4		38	3	4,680
CSS 2002-0040-4		0.4		45	4	4,680
CSS 2002-0050		0.5		45	4	4,680
CSS 2002-0060	0.6	45	4	4,680		
CSS 2003-0030	0.3	0.3	16°	45	4	4,080
CSS 2003-0045		0.45		45	4	4,080
CSS 2003-0060-3		0.6		38	3	4,080
CSS 2003-0060-4		0.6		45	4	4,080
CSS 2003-0075		0.75		45	4	4,080
CSS 2003-0090	0.9	45	4	4,080		

Unit (mm)

Model Number	Outside Diameter ϕD	Length of Cut ℓ	Shank Taper Angle Bta	Overall Length L	Shank Diameter ϕd	Suggested Retail Price ¥
CSS 2004-0040	0.4	0.4	16°	45	4	4,560
CSS 2004-0060		0.6		45	4	4,560
CSS 2004-0080-3		0.8		38	3	4,560
CSS 2004-0080-4				45	4	4,560
CSS 2004-0100		1		45	4	4,560
CSS 2004-0120		1.2		45	4	4,560
CSS 2005-0050		0.5		0.5	16°	45
CSS 2005-0075	0.75		45	4		2,280
CSS 2005-0080	0.8		38	3		2,280
CSS 2005-0100	1		45	4		2,280
CSS 2005-0125	1.25		45	4		2,280
CSS 2005-0150	1.5		45	4		2,280
CSS 2006-0060	0.6	0.6	16°	45	4	3,480
CSS 2006-0090		0.9		45	4	3,480
CSS 2006-0100		1		38	3	3,480
CSS 2006-0120		1.2		45	4	3,480
CSS 2006-0150		1.5		45	4	3,480
CSS 2006-0180		1.8		45	4	3,480
CSS 2007-0070		0.7		0.7	16°	45
CSS 2007-0100	1		38	3		3,840
CSS 2007-0140	1.4		45	4		3,840
CSS 2007-0175	1.75		45	4		3,840
CSS 2007-0210	2.1		45	4		3,840
CSS 2008-0080	0.8		0.8	16°		45
CSS 2008-0120-3		1.2	38		3	2,280
CSS 2008-0120-4			45		4	2,280
CSS 2008-0160		1.6	45		4	2,280
CSS 2008-0200		2	45		4	2,280
CSS 2008-0240		2.4	45		4	2,280
CSS 2009-0090		0.9	0.9		16°	45
CSS 2009-0120	1.2		38	3		3,840
CSS 2009-0180	1.8		45	4		3,840
CSS 2009-0225	2.25		45	4		3,840
CSS 2009-0270	2.7		45	4		3,840
CSS 2010-0100	1	1	16°	45	4	2,040
CSS 2010-0150		1.5		45	4	2,040
CSS 2010-0200		2		45	4	2,040
CSS 2010-0250		2.5		45	4	2,040
CSS 2010-0300		3		45	4	2,040
CSS 2015-0150	1.5	1.5	16°	45	4	2,040
CSS 2015-0225		2.25		45	4	2,040
CSS 2015-0300		3		45	4	2,040
CSS 2015-0375		3.75		45	4	2,040
CSS 2015-0450		4.5		45	4	2,040
CSS 2020-0200	2	2	16°	45	4	2,040
CSS 2020-0300		3		45	4	2,040
CSS 2020-0400		4		45	4	2,040
CSS 2020-0500		5		45	4	2,040
CSS 2020-0600		6		45	4	2,040

Ø3mm Shank
V SeriesUDC-PCD
SeriesCBN
Series

Square

Long Neck
Square

Radius

Long Neck
RadiusTaper Neck
RadiusBall / Long
Shank BallLong Neck
BallTaper Neck
Ball

Taper

Barrel

Spiral
V Cutter

Drill

Technical Data

Unit (mm)

Model Number	Outside Diameter φD	Length of Cut ℓ	Shank Taper Angle Bta	Overall Length L	Shank Diameter φd	Suggested Retail Price ¥
CSS 2025-0250	2.5	2.5	16°	50	4	2,040
CSS 2025-0375		3.75		50	4	2,040
CSS 2025-0500		5		50	4	2,040
CSS 2025-0625		6.25		50	4	2,040
CSS 2025-0750		7.5		50	4	2,040
CSS 2030-0300	3	3	16°	50	6	2,640
CSS 2030-0450		4.5		50	6	2,640
CSS 2030-0600		6		50	6	2,640
CSS 2030-0750		7.5		50	6	2,640
CSS 2030-0900	4	9	16°	50	6	2,640
CSS 2040-0400		4		50	6	2,880
CSS 2040-0600		6		50	6	2,880
CSS 2040-0800		8		50	6	2,880
CSS 2040-1000		10		50	6	2,880
CSS 2040-1200	12	50	6	2,880		
CSS 2050-0500	5	5	16°	50	6	3,120
CSS 2050-0750		7.5		50	6	3,120
CSS 2050-1000		10		50	6	3,120
CSS 2050-1250		12.5		60	6	3,120
CSS 2050-1500	15	60	6	3,120		
CSS 2060-0600	6	6	—	50	6	3,360
CSS 2060-0900		9		50	6	3,360
CSS 2060-1200		12		50	6	3,360
CSS 2060-1500		15		60	6	3,360
CSS 2060-1800		18		60	6	3,360
CSS 2070-1750	7	17.5	16°	70	8	8,700
CSS 2070-2100		21		80	8	8,700
CSS 2080-0800	8	8	—	70	8	6,320
CSS 2080-1200		12		70	8	6,320
CSS 2080-1600		16		70	8	6,320
CSS 2080-2000		20		70	8	6,320
CSS 2080-2400		24		80	8	6,320
CSS 2090-2250	9	22.5	16°	80	10	12,420
CSS 2090-2700		27		80	10	12,420
CSS 2100-1000	10	10	—	70	10	7,580
CSS 2100-1500		15		70	10	7,580
CSS 2100-2000		20		70	10	7,580
CSS 2100-2500		25		80	10	7,580
CSS 2100-3000		30		80	10	7,580
CSS 2110-2750	11	27.5	16°	80	12	17,160
CSS 2110-3300		33		80	12	17,160
CSS 2120-1200	12	12	—	80	12	11,170
CSS 2120-1800		18		80	12	11,170
CSS 2120-2400		24		80	12	11,170
CSS 2120-3000		30		80	12	11,170
CSS 2120-3600		36		90	12	11,170

φ3mm Shank
V Series

UDC-PCD
Series

CBN
Series

Square
Long Neck
Square

Radius
Long Neck
Radius

Ball / Long
Shank Ball

Long Neck
Ball
Taper Neck
Ball

Taper

Barrel

Spiral
V Cutter

Drill

Technical Data

Milling Conditions for CSS

Slotting

◆ 1D flute length type L/D=1

WORK MATERIAL			CARBON STEELS S45C / S50C Annealed Materials (~225HB)			ALLOY STEELS SK / SCM Annealed Materials (225~325HB)			STAINLESS STEELS SUS304 * Use water soluble or oil coolant.		
Model Number	Outside Diameter (mm)	Length of Cut (mm)	Spindle Speed (min ⁻¹)	Feed Rate (mm/min)	Milling Amount (mm)	Spindle Speed (min ⁻¹)	Feed Rate (mm/min)	Milling Amount (mm)	Spindle Speed (min ⁻¹)	Feed Rate (mm/min)	Milling Amount (mm)
				Slotting	a_p		Slotting	a_p		Slotting	a_p
2001-0010	0.1	0.1	30,000	30	0.01	30,000	30	0.01	30,000	30	0.01
2002-0020	0.2	0.2	30,000	85	0.02	30,000	85	0.02	30,000	60	0.02
2003-0030	0.3	0.3	30,000	110	0.03	30,000	110	0.03	30,000	110	0.03
2004-0040	0.4	0.4	30,000	120	0.04	30,000	120	0.04	30,000	120	0.04
2005-0050	0.5	0.5	27,000	120	0.05	24,000	105	0.05	24,000	120	0.05
2006-0060	0.6	0.6	24,000	120	0.09	20,000	90	0.09	20,000	120	0.09
2007-0070	0.7	0.7	22,500	115	0.105	17,800	90	0.105	17,800	120	0.105
2008-0080	0.8	0.8	21,000	110	0.12	16,700	90	0.12	16,700	120	0.12
2009-0090	0.9	0.9	19,500	105	0.135	15,600	85	0.135	15,600	120	0.135
2010-0100	1	1	18,000	100	1	14,500	75	1	14,500	125	1
2015-0150	1.5	1.5	16,000	275	1.5	13,000	200	1.5	13,000	135	1.5
2020-0200	2	2	12,000	275	2	10,000	200	2	10,000	135	2
2025-0250	2.5	2.5	10,200	375	2.5	8,400	260	2.5	8,400	140	2.5
2030-0300	3	3	8,500	475	3	6,800	325	3	6,800	150	3
2040-0400	4	4	7,200	475	4	5,700	325	4	5,700	175	4
2050-0500	5	5	6,000	500	5	4,800	350	5	4,800	200	5
2060-0600	6	6	5,000	500	6	4,000	350	6	4,000	200	6
2080-0800	8	8	3,500	475	8	2,700	350	8	2,400	150	8
2100-1000	10	10	2,300	450	10	1,900	325	10	1,400	100	10
2120-1200	12	12	1,850	425	12	1,550	300	12	1,250	90	12

WORK MATERIAL			PREHARDENED STEELS HPM / NAK (30~45HRC)			HARDENED STEELS SKD / SKT / STAVAX (45~55HRC)		
Model Number	Outside Diameter (mm)	Length of Cut (mm)	Spindle Speed (min ⁻¹)	Feed Rate (mm/min)	Milling Amount (mm)	Spindle Speed (min ⁻¹)	Feed Rate (mm/min)	Milling Amount (mm)
				Slotting	a_p		Slotting	a_p
2001-0010	0.1	0.1	30,000	15	0.01	24,000	10	0.004
2002-0020	0.2	0.2	30,000	30	0.02	23,000	25	0.008
2003-0030	0.3	0.3	30,000	55	0.03	20,000	25	0.012
2004-0040	0.4	0.4	30,000	60	0.04	16,800	25	0.016
2005-0050	0.5	0.5	24,000	60	0.05	14,400	30	0.025
2006-0060	0.6	0.6	20,000	60	0.09	12,000	35	0.03
2007-0070	0.7	0.7	17,800	60	0.105	10,000	35	0.035
2008-0080	0.8	0.8	16,700	60	0.12	8,500	35	0.04
2009-0090	0.9	0.9	15,600	60	0.135	7,300	35	0.045
2010-0100	1	1	14,500	60	1	6,550	35	0.2
2015-0150	1.5	1.5	12,000	160	1.5	4,400	35	0.3
2020-0200	2	2	9,000	160	2	3,300	35	0.4
2025-0250	2.5	2.5	7,900	210	2.5	2,750	35	0.5
2030-0300	3	3	6,800	260	3	2,200	35	0.6
2040-0400	4	4	5,100	260	4	1,650	40	0.8
2050-0500	5	5	4,050	260	5	1,300	40	1
2060-0600	6	6	3,300	260	6	1,100	40	1.2
2080-0800	8	8	2,300	235	8	800	40	1.6
2100-1000	10	10	1,500	225	10	690	40	2
2120-1200	12	12	1,200	210	12	550	40	2.4

Ø3mm Shank
V SeriesUDC-PCD
SeriesCBN
Series

Square

Long Neck
Square

Radius

Long Neck
RadiusTaper Neck
RadiusBall / Long
Shank BallLong Neck
BallTaper Neck
Ball

Taper

Barrel

Spiral
V Cutter

Drill

Technical Data

Milling Conditions for CSS

◆ 1.5D flute length type $1 < L/D \leq 1.5$

WORK MATERIAL			CARBON STEELS S45C / S50C Annealed Materials (~225HB)			ALLOY STEELS SK / SCM Annealed Materials (225~325HB)			STAINLESS STEELS SUS304 *Use water soluble or oil coolant.		
Model Number	Outside Diameter (mm)	Length of Cut (mm)	Spindle Speed (min ⁻¹)	Feed Rate (mm/min)	Milling Amount (mm)	Spindle Speed (min ⁻¹)	Feed Rate (mm/min)	Milling Amount (mm)	Spindle Speed (min ⁻¹)	Feed Rate (mm/min)	Milling Amount (mm)
				Slotting	a_p		Slotting	a_p		Slotting	a_p
2001-0015	0.1	0.15	30,000	30	0.01	30,000	30	0.01	30,000	30	0.01
2002-0030	0.2	0.3	30,000	85	0.02	30,000	85	0.02	30,000	60	0.02
2003-0045	0.3	0.45	30,000	110	0.03	30,000	110	0.03	30,000	110	0.03
2004-0060	0.4	0.6	30,000	120	0.04	30,000	120	0.04	30,000	120	0.04
2005-0075	0.5	0.75	27,000	120	0.05	24,000	105	0.05	24,000	120	0.05
2006-0090	0.6	0.9	24,000	120	0.09	20,000	90	0.09	20,000	120	0.09
2007-0100	0.7	1	22,500	115	0.105	17,800	90	0.105	17,800	120	0.105
2008-0120	0.8	1.2	21,000	110	0.12	16,700	90	0.12	16,700	120	0.12
2009-0120	0.9	1.2	19,500	105	0.135	15,600	85	0.135	15,600	120	0.135
2010-0150	1	1.5	18,000	100	1	14,500	75	1	14,500	125	1
2015-0225	1.5	2.25	16,000	275	1.5	13,000	200	1.5	13,000	135	1.5
2020-0300	2	3	12,000	275	2	10,000	200	2	10,000	135	2
2025-0375	2.5	3.75	10,200	375	2.5	8,400	260	2.5	8,400	140	2.5
2030-0450	3	4.5	8,500	475	3	6,800	325	3	6,800	150	3
2040-0600	4	6	7,200	475	4	5,700	325	4	5,700	175	4
2050-0750	5	7.5	6,000	500	5	4,800	350	5	4,800	200	5
2060-0900	6	9	5,000	500	6	4,000	350	6	4,000	200	6
2080-1200	8	12	3,500	475	8	2,700	350	8	2,400	150	8
2100-1500	10	15	2,300	450	10	1,900	325	10	1,400	100	10
2120-1800	12	18	1,850	425	12	1,550	300	12	1,250	90	12

WORK MATERIAL			PREHARDENED STEELS HPM / NAK (30~45HRC)			HARDENED STEELS SKD / SKT / STAVAX (45~55HRC)		
Model Number	Outside Diameter (mm)	Length of Cut (mm)	Spindle Speed (min ⁻¹)	Feed Rate (mm/min)	Milling Amount (mm)	Spindle Speed (min ⁻¹)	Feed Rate (mm/min)	Milling Amount (mm)
				Slotting	a_p		Slotting	a_p
2001-0015	0.1	0.15	30,000	15	0.01	24,000	10	0.004
2002-0030	0.2	0.3	30,000	30	0.02	23,000	25	0.008
2003-0045	0.3	0.45	30,000	55	0.03	20,000	25	0.012
2004-0060	0.4	0.6	30,000	60	0.04	16,800	25	0.016
2005-0075	0.5	0.75	24,000	60	0.05	14,400	30	0.025
2006-0090	0.6	0.9	20,000	60	0.09	12,000	35	0.03
2007-0100	0.7	1	17,800	60	0.105	10,000	35	0.035
2008-0120	0.8	1.2	16,700	60	0.12	8,500	35	0.04
2009-0120	0.9	1.2	15,600	60	0.135	7,300	35	0.045
2010-0150	1	1.5	14,500	60	1	6,550	35	0.2
2015-0225	1.5	2.25	12,000	160	1.5	4,400	35	0.3
2020-0300	2	3	9,000	160	2	3,300	35	0.4
2025-0375	2.5	3.75	7,900	210	2.5	2,750	35	0.5
2030-0450	3	4.5	6,800	260	3	2,200	35	0.6
2040-0600	4	6	5,100	260	4	1,650	40	0.8
2050-0750	5	7.5	4,050	260	5	1,300	40	1
2060-0900	6	9	3,300	260	6	1,100	40	1.2
2080-1200	8	12	2,300	235	8	800	40	1.6
2100-1500	10	15	1,500	225	10	690	40	2
2120-1800	12	18	1,200	210	12	550	40	2.4

Milling Conditions for CSS

◆ 2D flute length type $1.5 < L/D \leq 2$

WORK MATERIAL			CARBON STEELS S45C / S50C Annealed Materials (~225HB)			ALLOY STEELS SK / SCM Annealed Materials (225~325HB)			STAINLESS STEELS SUS304 * Use water soluble or oil coolant.		
Model Number	Outside Diameter (mm)	Length of Cut (mm)	Spindle Speed (min ⁻¹)	Feed Rate (mm/min)	Milling Amount (mm)	Spindle Speed (min ⁻¹)	Feed Rate (mm/min)	Milling Amount (mm)	Spindle Speed (min ⁻¹)	Feed Rate (mm/min)	Milling Amount (mm)
				Slotting	a_p		Slotting	a_p		Slotting	a_p
2001-0020	0.1	0.2	30,000	30	0.01	30,000	30	0.01	30,000	30	0.01
2002-0040	0.2	0.4	30,000	85	0.02	30,000	85	0.02	30,000	60	0.02
2003-0060	0.3	0.6	30,000	110	0.03	30,000	110	0.03	30,000	110	0.03
2004-0080	0.4	0.8	30,000	120	0.04	30,000	120	0.04	30,000	120	0.04
2005-0080	0.5	0.8	27,000	120	0.05	24,000	105	0.05	24,000	120	0.05
2005-0100	0.5	1	27,000	120	0.05	24,000	105	0.05	24,000	120	0.05
2006-0100	0.6	1	24,000	120	0.09	20,000	90	0.09	20,000	120	0.09
2006-0120	0.6	1.2	24,000	120	0.09	20,000	90	0.09	20,000	120	0.09
2007-0140	0.7	1.4	22,500	115	0.105	17,800	90	0.105	17,800	120	0.105
2008-0160	0.8	1.6	21,000	110	0.12	16,700	90	0.12	16,700	120	0.12
2009-0180	0.9	1.8	19,500	105	0.135	15,600	85	0.135	15,600	120	0.135
2010-0200	1	2	18,000	100	0.8	14,500	75	0.8	14,500	125	0.8
2015-0300	1.5	3	16,000	275	1.2	13,000	200	1.2	13,000	135	1.2
2020-0400	2	4	12,000	275	1.6	10,000	200	1.6	10,000	135	1.6
2025-0500	2.5	5	10,200	375	2	8,400	260	2	8,400	140	2
2030-0600	3	6	8,500	475	2.4	6,800	325	2.4	6,800	150	2.4
2040-0800	4	8	7,200	475	3.2	5,700	325	3.2	5,700	175	3.2
2050-1000	5	10	6,000	500	4	4,800	350	4	4,800	200	4
2060-1200	6	12	5,000	500	4.8	4,000	350	4.8	4,000	200	4.8
2080-1600	8	16	3,500	475	6.4	2,700	350	6.4	2,400	150	6.4
2100-2000	10	20	2,300	450	8	1,900	325	8	1,400	100	8
2120-2400	12	24	1,850	425	9.6	1,550	300	9.6	1,250	90	9.6

WORK MATERIAL			PREHARDENED STEELS HPM / NAK (30~45HRC)			HARDENED STEELS SKD / SKT / STAVAX (45~55HRC)		
Model Number	Outside Diameter (mm)	Length of Cut (mm)	Spindle Speed (min ⁻¹)	Feed Rate (mm/min)	Milling Amount (mm)	Spindle Speed (min ⁻¹)	Feed Rate (mm/min)	Milling Amount (mm)
				Slotting	a_p		Slotting	a_p
2001-0020	0.1	0.2	30,000	15	0.01	24,000	10	0.003
2002-0040	0.2	0.4	30,000	30	0.02	23,000	25	0.008
2003-0060	0.3	0.6	30,000	55	0.03	20,000	25	0.012
2004-0080	0.4	0.8	30,000	60	0.04	16,800	25	0.016
2005-0080	0.5	0.8	24,000	60	0.05	14,400	30	0.025
2005-0100	0.5	1	24,000	60	0.05	14,400	30	0.025
2006-0100	0.6	1	20,000	60	0.09	12,000	35	0.03
2006-0120	0.6	1.2	20,000	60	0.09	12,000	35	0.03
2007-0140	0.7	1.4	17,800	60	0.105	10,000	35	0.035
2008-0160	0.8	1.6	16,700	60	0.12	8,500	35	0.04
2009-0180	0.9	1.8	15,600	60	0.135	7,300	35	0.045
2010-0200	1	2	14,500	60	0.8	6,550	35	0.15
2015-0300	1.5	3	12,000	160	1.2	4,400	35	0.225
2020-0400	2	4	9,000	160	1.6	3,300	35	0.3
2025-0500	2.5	5	7,900	210	2	2,750	35	0.37
2030-0600	3	6	6,800	260	2.4	2,200	35	0.45
2040-0800	4	8	5,100	260	3.2	1,650	40	0.6
2050-1000	5	10	4,050	260	4	1,300	40	0.75
2060-1200	6	12	3,300	260	4.8	1,100	40	0.9
2080-1600	8	16	2,300	235	3.2	800	40	1.2
2100-2000	10	20	1,500	225	4	690	40	1.5
2120-2400	12	24	1,200	210	4.8	550	40	1.8

Ø3mm Shank
V SeriesUDC-PCD
SeriesCBN
SeriesSquare
Long Neck
SquareRadius
Long Neck
RadiusTaper Neck
RadiusBall / Long
Shank Ball
Long Neck
BallTaper Neck
Ball

Taper

Barrel

Spiral
V Cutter

Drill

Technical Data

Milling Conditions for CSS

◆ 2.5D flute length type $2 < L/D \leq 2.5$

WORK MATERIAL			CARBON STEELS S45C / S50C Annealed Materials (~225HB)			ALLOY STEELS SK / SCM Annealed Materials (225~325HB)			STAINLESS STEELS SUS304 * Use water soluble or oil coolant.		
Model Number	Outside Diameter (mm)	Length of Cut (mm)	Spindle Speed (min ⁻¹)	Feed Rate (mm/min)	Milling Amount (mm)	Spindle Speed (min ⁻¹)	Feed Rate (mm/min)	Milling Amount (mm)	Spindle Speed (min ⁻¹)	Feed Rate (mm/min)	Milling Amount (mm)
				Slotting	a_p		Slotting	a_p		Slotting	a_p
2001-0025	0.1	0.25	30,000	30	0.007	30,000	30	0.007	30,000	30	0.007
2002-0050	0.2	0.5	30,000	85	0.014	30,000	85	0.014	30,000	60	0.014
2003-0075	0.3	0.75	30,000	110	0.021	30,000	110	0.021	30,000	110	0.021
2004-0100	0.4	1	30,000	120	0.028	30,000	120	0.028	30,000	120	0.028
2005-0125	0.5	1.25	27,000	120	0.035	24,000	105	0.035	24,000	120	0.035
2006-0150	0.6	1.5	24,000	120	0.06	20,000	90	0.06	20,000	120	0.06
2007-0175	0.7	1.75	22,500	115	0.07	17,800	90	0.07	17,800	120	0.07
2008-0200	0.8	2	21,000	110	0.08	16,700	90	0.08	16,700	120	0.08
2009-0225	0.9	2.25	19,500	105	0.09	15,600	85	0.09	15,600	120	0.09
2010-0250	1	2.5	20,000	130	0.5	15,000	60	0.5	11,000	120	0.25
2015-0375	1.5	3.75	12,800	170	0.75	10,000	100	0.75	7,000	120	0.375
2020-0500	2	5	9,300	210	1	7,500	140	1	5,000	120	0.5
2025-0625	2.5	6.25	7,600	235	1.25	6,250	160	1.25	4,100	120	0.62
2030-0750	3	7.5	5,900	260	1.5	5,000	180	1.5	3,200	120	0.75
2040-1000	4	10	4,200	300	2	3,750	220	2	2,250	120	1
2050-1250	5	12.5	3,200	340	2.5	3,000	260	2.5	1,700	120	1.25
2060-1500	6	15	2,500	380	3	2,500	300	3	1,350	120	1.5
2070-1750	7	17.5	2,270	345	3.5	2,270	270	3.5	1,150	105	1.75
2080-2000	8	20	2,100	320	4	2,100	250	4	1,000	90	2
2090-2250	9	22.5	1,935	300	4.5	1,935	220	4.5	895	80	2.25
2100-2500	10	25	1,800	280	5	1,800	200	5	810	75	2.5
2110-2750	11	27.5	1,635	265	5.5	1,635	180	5.5	735	70	2.75
2120-3000	12	30	1,500	250	6	1,500	160	6	670	65	3

WORK MATERIAL			PREHARDENED STEELS HPM / NAK (30~45HRC)			HARDENED STEELS SKD / SKT / STAVAX (45~55HRC)		
Model Number	Outside Diameter (mm)	Length of Cut (mm)	Spindle Speed (min ⁻¹)	Feed Rate (mm/min)	Milling Amount (mm)	Spindle Speed (min ⁻¹)	Feed Rate (mm/min)	Milling Amount (mm)
				Slotting	a_p		Slotting	a_p
2001-0025	0.1	0.25	30,000	15	0.007	24,000	10	0.002
2002-0050	0.2	0.5	30,000	30	0.014	23,000	25	0.004
2003-0075	0.3	0.75	30,000	55	0.021	20,000	25	0.006
2004-0100	0.4	1	30,000	60	0.028	16,800	25	0.008
2005-0125	0.5	1.25	24,000	60	0.035	14,400	30	0.015
2006-0150	0.6	1.5	20,000	60	0.06	12,000	35	0.018
2007-0175	0.7	1.75	17,800	60	0.07	10,000	35	0.021
2008-0200	0.8	2	16,700	60	0.08	8,500	35	0.024
2009-0225	0.9	2.25	15,600	60	0.09	7,300	35	0.027
2010-0250	1	2.5	11,000	60	0.25	5,500	20	0.05
2015-0375	1.5	3.75	7,500	90	0.375	3,750	25	0.075
2020-0500	2	5	5,700	120	0.5	2,850	30	0.1
2025-0625	2.5	6.25	4,800	135	0.62	2,400	30	0.12
2030-0750	3	7.5	3,900	150	0.75	1,950	35	0.15
2040-1000	4	10	2,900	180	1	1,450	40	0.2
2050-1250	5	12.5	2,400	210	1.25	1,200	45	0.25
2060-1500	6	15	2,000	240	1.5	1,000	55	0.3
2070-1750	7	17.5	1,630	230	1.5	815	55	0.3
2080-2000	8	20	1,350	220	1.5	675	55	0.3
2090-2250	9	22.5	1,135	210	1.5	565	55	0.3
2100-2500	10	25	960	200	1.5	480	55	0.3
2110-2750	11	27.5	845	180	1.5	425	55	0.3
2120-3000	12	30	750	160	1.5	375	55	0.3

Milling Conditions for CSS

◆ 3D flute length type L/D=3

WORK MATERIAL			CARBON STEELS S45C / S50C Annealed Materials (~225HB)			ALLOY STEELS SK / SCM Annealed Materials (225~325HB)			STAINLESS STEELS SUS304 * Use water soluble or oil coolant.		
Model Number	Outside Diameter (mm)	Length of Cut (mm)	Spindle Speed (min ⁻¹)	Feed Rate (mm/min)	Milling Amount (mm)	Spindle Speed (min ⁻¹)	Feed Rate (mm/min)	Milling Amount (mm)	Spindle Speed (min ⁻¹)	Feed Rate (mm/min)	Milling Amount (mm)
				Slotting	a_p		Slotting	a_p		Slotting	a_p
2001-0030	0.1	0.3	30,000	30	0.005	30,000	30	0.005	30,000	30	0.005
2002-0060	0.2	0.6	30,000	85	0.01	30,000	85	0.01	30,000	60	0.01
2003-0090	0.3	0.9	30,000	110	0.015	30,000	110	0.015	30,000	110	0.015
2004-0120	0.4	1.2	30,000	120	0.02	30,000	120	0.02	30,000	120	0.02
2005-0150	0.5	1.5	27,000	120	0.025	24,000	105	0.025	24,000	120	0.025
2006-0180	0.6	1.8	24,000	120	0.05	20,000	90	0.05	20,000	120	0.05
2007-0210	0.7	2.1	22,500	115	0.056	17,800	90	0.056	17,800	120	0.056
2008-0240	0.8	2.4	21,000	110	0.064	16,700	90	0.064	16,700	120	0.064
2009-0270	0.9	2.7	19,500	105	0.072	15,600	85	0.072	15,600	120	0.072
2010-0300	1	3	20,000	130	0.5	15,000	60	0.5	11,000	120	0.25
2015-0450	1.5	4.5	12,800	170	0.75	10,000	100	0.75	7,000	120	0.375
2020-0600	2	6	9,300	210	1	7,500	140	1	5,000	120	0.5
2025-0750	2.5	7.5	7,600	235	1.25	6,250	160	1.25	4,100	120	0.62
2030-0900	3	9	5,900	260	1.5	5,000	180	1.5	3,200	120	0.75
2040-1200	4	12	4,200	300	2	3,750	220	2	2,250	120	1
2050-1500	5	15	3,200	340	2.5	3,000	260	2.5	1,700	120	1.25
2060-1800	6	18	2,500	380	3	2,500	300	3	1,350	120	1.5
2070-2100	7	21	2,270	345	3.5	2,270	270	3.5	1,150	105	1.75
2080-2400	8	24	2,100	320	4	2,100	250	4	1,000	90	2
2090-2700	9	27	1,935	300	4.5	1,935	220	4.5	895	80	2.25
2100-3000	10	30	1,800	280	5	1,800	200	5	810	75	2.5
2110-3300	11	33	1,635	265	5.5	1,635	180	5.5	735	70	2.75
2120-3600	12	36	1,500	250	6	1,500	160	6	670	65	3

WORK MATERIAL			PREHARDENED STEELS HPM / NAK (30~45HRC)			HARDENED STEELS SKD / SKT / STAVAX (45~55HRC)		
Model Number	Outside Diameter (mm)	Length of Cut (mm)	Spindle Speed (min ⁻¹)	Feed Rate (mm/min)	Milling Amount (mm)	Spindle Speed (min ⁻¹)	Feed Rate (mm/min)	Milling Amount (mm)
				Slotting	a_p		Slotting	a_p
2001-0030	0.1	0.3	30,000	15	0.005	24,000	10	0.001
2002-0060	0.2	0.6	30,000	30	0.01	23,000	25	0.002
2003-0090	0.3	0.9	30,000	55	0.015	20,000	25	0.003
2004-0120	0.4	1.2	30,000	60	0.02	16,800	25	0.004
2005-0150	0.5	1.5	24,000	60	0.025	14,400	30	0.013
2006-0180	0.6	1.8	20,000	60	0.05	12,000	35	0.015
2007-0210	0.7	2.1	17,800	60	0.056	10,000	35	0.018
2008-0240	0.8	2.4	16,700	60	0.064	8,500	35	0.02
2009-0270	0.9	2.7	15,600	60	0.072	7,300	35	0.023
2010-0300	1	3	11,000	60	0.25	5,500	15	0.05
2015-0450	1.5	4.5	7,500	90	0.375	3,750	20	0.075
2020-0600	2	6	5,700	120	0.5	2,850	25	0.1
2025-0750	2.5	7.5	4,800	135	0.62	2,400	30	0.12
2030-0900	3	9	3,900	150	0.75	1,950	35	0.15
2040-1200	4	12	2,900	180	1	1,450	40	0.2
2050-1500	5	15	2,400	210	1.25	1,200	45	0.25
2060-1800	6	18	2,000	240	1.5	1,000	55	0.3
2070-2100	7	21	1,630	230	1.5	815	55	0.3
2080-2400	8	24	1,350	220	1.5	675	55	0.3
2090-2700	9	27	1,135	210	1.5	565	55	0.3
2100-3000	10	30	960	200	1.5	480	55	0.3
2110-3300	11	33	845	180	1.5	425	55	0.3
2120-3600	12	36	750	160	1.5	375	55	0.3

Ø3mm Shank
V SeriesUDC-PCD
SeriesCBN
Series

Square

Long Neck
Square

Radius

Long Neck
RadiusTaper Neck
RadiusBall / Long
Shank BallLong Neck
BallTaper Neck
Ball

Taper

Barrel

Spiral
V Cutter

Drill

Technical Data

Milling Conditions for CSS

Side Milling

◆ 1D flute length type L/D=1

WORK MATERIAL			CARBON STEELS S45C / S50C Annealed Materials (~225HB)				ALLOY STEELS SK / SCM Annealed Materials (225~325HB)				STAINLESS STEELS SUS304 * Use water soluble or oil coolant.			
Model Number	Outside Diameter (mm)	Length of Cut (mm)	Spindle Speed (min ⁻¹)	Feed Rate (mm/min)	Milling Amount (mm)		Spindle Speed (min ⁻¹)	Feed Rate (mm/min)	Milling Amount (mm)		Spindle Speed (min ⁻¹)	Feed Rate (mm/min)	Milling Amount (mm)	
				Side Milling	a _p	a _e		Side Milling	a _p	a _e		Side Milling	a _p	a _e
2001-0010	0.1	0.1	30,000	70	0.1	0.007	30,000	55	0.1	0.006	30,000	60	0.1	0.005
2002-0020	0.2	0.2	30,000	180	0.2	0.014	30,000	140	0.2	0.012	30,000	120	0.2	0.01
2003-0030	0.3	0.3	30,000	280	0.3	0.021	30,000	210	0.3	0.018	30,000	180	0.3	0.015
2004-0040	0.4	0.4	30,000	380	0.4	0.028	30,000	260	0.4	0.024	30,000	225	0.4	0.02
2005-0050	0.5	0.5	27,000	490	0.5	0.035	24,000	360	0.5	0.03	24,000	315	0.5	0.025
2006-0060	0.6	0.6	24,000	600	0.6	0.042	20,000	450	0.6	0.036	20,000	400	0.6	0.03
2007-0070	0.7	0.7	22,500	600	0.7	0.049	17,800	450	0.7	0.042	17,800	400	0.7	0.035
2008-0080	0.8	0.8	21,000	600	0.8	0.056	16,700	450	0.8	0.048	16,700	400	0.8	0.04
2009-0090	0.9	0.9	19,500	600	0.9	0.063	15,600	450	0.9	0.054	15,600	400	0.9	0.045
2010-0100	1	1	18,000	600	1	0.075	14,500	450	1	0.075	14,500	500	1	0.05
2015-0150	1.5	1.5	16,000	900	1.5	0.113	13,000	600	1.5	0.113	13,000	750	1.5	0.075
2020-0200	2	2	12,000	900	2	0.15	10,000	600	2	0.15	10,000	750	2	0.1
2025-0250	2.5	2.5	10,200	900	2.5	0.19	8,400	600	2.5	0.19	8,400	750	2.5	0.13
2030-0300	3	3	8,500	900	3	0.225	6,800	600	3	0.225	6,800	750	3	0.15
2040-0400	4	4	7,200	675	4	0.6	5,700	500	4	0.6	5,700	575	4	0.4
2050-0500	5	5	6,000	750	5	0.75	4,800	550	5	0.75	4,800	650	5	0.5
2060-0600	6	6	5,000	800	6	0.9	4,000	600	6	0.9	4,000	650	6	0.6
2080-0800	8	8	3,500	700	8	1.2	2,700	525	8	1.2	2,400	600	8	0.8
2100-1000	10	10	2,300	600	10	1.5	1,900	450	10	1.5	1,400	500	10	1
2120-1200	12	12	1,850	550	12	1.8	1,550	400	12	1.8	1,250	450	12	1.2

WORK MATERIAL			PREHARDENED STEELS HPM / NAK (30~45HRC)				HARDENED STEELS SKD / SKT / STAVAX (45~55HRC)			
Model Number	Outside Diameter (mm)	Length of Cut (mm)	Spindle Speed (min ⁻¹)	Feed Rate (mm/min)	Milling Amount (mm)		Spindle Speed (min ⁻¹)	Feed Rate (mm/min)	Milling Amount (mm)	
				Side Milling	a _p	a _e		Side Milling	a _p	a _e
2001-0010	0.1	0.1	30,000	40	0.1	0.005	24,000	25	0.1	0.004
2002-0020	0.2	0.2	30,000	80	0.2	0.01	23,000	35	0.2	0.008
2003-0030	0.3	0.3	30,000	120	0.3	0.015	20,000	45	0.3	0.012
2004-0040	0.4	0.4	30,000	150	0.4	0.02	16,800	55	0.4	0.016
2005-0050	0.5	0.5	24,000	210	0.5	0.025	14,400	65	0.5	0.02
2006-0060	0.6	0.6	20,000	265	0.6	0.03	12,000	80	0.6	0.024
2007-0070	0.7	0.7	17,800	265	0.7	0.035	10,000	80	0.7	0.028
2008-0080	0.8	0.8	16,700	265	0.8	0.04	8,500	80	0.8	0.032
2009-0090	0.9	0.9	15,600	265	0.9	0.045	7,300	80	0.9	0.036
2010-0100	1	1	14,500	300	1	0.05	6,550	80	1	0.045
2015-0150	1.5	1.5	12,000	450	1.5	0.075	4,400	100	1.5	0.068
2020-0200	2	2	9,000	450	2	0.1	3,300	115	2	0.09
2025-0250	2.5	2.5	7,900	450	2.5	0.13	2,750	120	2.5	0.11
2030-0300	3	3	6,800	450	3	0.15	2,200	130	3	0.135
2040-0400	4	4	5,100	350	4	0.4	1,650	150	4	0.18
2050-0500	5	5	4,050	425	5	0.5	1,300	160	5	0.225
2060-0600	6	6	3,300	500	6	0.6	1,100	180	6	0.27
2080-0800	8	8	2,300	450	8	0.8	800	130	8	0.36
2100-1000	10	10	1,500	450	10	1	690	110	10	0.45
2120-1200	12	12	1,200	400	12	1.2	550	110	12	0.54

Milling Conditions for CSS

◆ 1.5D flute length type $1 < L/D \leq 1.5$

WORK MATERIAL			CARBON STEELS S45C / S50C Annealed Materials (~225HB)				ALLOY STEELS SK / SCM Annealed Materials (225~325HB)				STAINLESS STEELS SUS304 * Use water soluble or oil coolant.						
Model Number	Outside Diameter (mm)	Length of Cut (mm)	Spindle Speed (min ⁻¹)	Feed Rate (mm/min)		Milling Amount (mm)		Spindle Speed (min ⁻¹)	Feed Rate (mm/min)		Milling Amount (mm)		Spindle Speed (min ⁻¹)	Feed Rate (mm/min)		Milling Amount (mm)	
				Side Milling	a_p	a_e	Side Milling		a_p	a_e	Side Milling	a_p		a_e	Side Milling	a_p	a_e
2001-0015	0.1	0.15	30,000	70	0.15	0.007	30,000	55	0.15	0.006	30,000	60	0.15	0.005			
2002-0030	0.2	0.3	30,000	180	0.3	0.014	30,000	140	0.3	0.012	30,000	120	0.3	0.01			
2003-0045	0.3	0.45	30,000	280	0.45	0.021	30,000	210	0.45	0.018	30,000	180	0.45	0.015			
2004-0060	0.4	0.6	30,000	380	0.6	0.028	30,000	260	0.6	0.024	30,000	225	0.6	0.02			
2005-0075	0.5	0.75	27,000	490	0.75	0.035	24,000	360	0.75	0.03	24,000	315	0.75	0.025			
2006-0090	0.6	0.9	24,000	600	0.9	0.042	20,000	450	0.9	0.036	20,000	400	0.9	0.03			
2007-0100	0.7	1	22,500	600	1	0.049	17,800	450	1	0.042	17,800	400	1	0.035			
2008-0120	0.8	1.2	21,000	600	1.2	0.056	16,700	450	1.2	0.048	16,700	400	1.2	0.04			
2009-0120	0.9	1.2	19,500	600	1.2	0.063	15,600	450	1.2	0.054	15,600	400	1.2	0.045			
2010-0150	1	1.5	18,000	600	1.5	0.075	14,500	450	1.5	0.075	14,500	500	1.5	0.05			
2015-0225	1.5	2.25	16,000	900	2.25	0.113	13,000	600	2.25	0.113	13,000	750	2.25	0.075			
2020-0300	2	3	12,000	900	3	0.15	10,000	600	3	0.15	10,000	750	3	0.1			
2025-0375	2.5	3.75	10,200	900	3.75	0.19	8,400	600	3.75	0.19	8,400	750	3.75	0.13			
2030-0450	3	4.5	8,500	900	4.5	0.225	6,800	600	4.5	0.225	6,800	750	4.5	0.15			
2040-0600	4	6	7,200	675	6	0.6	5,700	500	6	0.6	5,700	575	6	0.4			
2050-0750	5	7.5	6,000	750	7.5	0.75	4,800	550	7.5	0.75	4,800	650	7.5	0.5			
2060-0900	6	9	5,000	800	9	0.9	4,000	600	9	0.9	4,000	650	9	0.6			
2080-1200	8	12	3,500	700	12	1.2	2,700	525	12	1.2	2,400	600	12	0.8			
2100-1500	10	15	2,300	600	15	1.5	1,900	450	15	1.5	1,400	500	15	1			
2120-1800	12	18	1,850	550	18	1.8	1,550	400	18	1.8	1,250	450	18	1.2			

WORK MATERIAL			PREHARDENED STEELS HPM / NAK (30~45HRC)				HARDENED STEELS SKD / SKT / STAVAX (45~55HRC)					
Model Number	Outside Diameter (mm)	Length of Cut (mm)	Spindle Speed (min ⁻¹)	Feed Rate (mm/min)		Milling Amount (mm)		Spindle Speed (min ⁻¹)	Feed Rate (mm/min)		Milling Amount (mm)	
				Side Milling	a_p	a_e	Side Milling		a_p	a_e		
2001-0015	0.1	0.15	30,000	40	0.15	0.005	24,000	25	0.15	0.004		
2002-0030	0.2	0.3	30,000	80	0.3	0.01	23,000	35	0.3	0.008		
2003-0045	0.3	0.45	30,000	120	0.45	0.015	20,000	45	0.45	0.012		
2004-0060	0.4	0.6	30,000	150	0.6	0.02	16,800	55	0.6	0.016		
2005-0075	0.5	0.75	24,000	210	0.75	0.025	14,400	65	0.75	0.02		
2006-0090	0.6	0.9	20,000	265	0.9	0.03	12,000	80	0.9	0.024		
2007-0100	0.7	1	17,800	265	1	0.035	10,000	80	1	0.028		
2008-0120	0.8	1.2	16,700	265	1.2	0.04	8,500	80	1.2	0.032		
2009-0120	0.9	1.2	15,600	265	1.2	0.045	7,300	80	1.2	0.036		
2010-0150	1	1.5	14,500	300	1.5	0.05	6,550	80	1	0.045		
2015-0225	1.5	2.25	12,000	450	2.25	0.075	4,400	100	1.5	0.068		
2020-0300	2	3	9,000	450	3	0.1	3,300	115	2	0.09		
2025-0375	2.5	3.75	7,900	450	3.75	0.13	2,750	120	2.5	0.11		
2030-0450	3	4.5	6,800	450	4.5	0.15	2,200	130	3	0.135		
2040-0600	4	6	5,100	350	6	0.4	1,650	150	4	0.18		
2050-0750	5	7.5	4,050	425	7.5	0.5	1,300	160	5	0.225		
2060-0900	6	9	3,300	500	9	0.6	1,100	180	6	0.27		
2080-1200	8	12	2,300	450	12	0.8	800	130	12	0.36		
2100-1500	10	15	1,500	450	15	1	690	110	15	0.45		
2120-1800	12	18	1,200	400	18	1.2	550	110	18	0.54		

Ø3mm Shank
V SeriesUDC-PCD
SeriesCBN
Series

Square

Long Neck
Square

Radius

Long Neck
RadiusTaper Neck
RadiusBall / Long
Shank BallLong Neck
BallTaper Neck
Ball

Taper

Barrel

Spiral
V Cutter

Drill

Technical Data

Milling Conditions for CSS

◆ 2D flute length type $1.5 < L/D \leq 2$

WORK MATERIAL			CARBON STEELS S45C / S50C Annealed Materials (~225HB)				ALLOY STEELS SK / SCM Annealed Materials (225~325HB)				STAINLESS STEELS SUS304 * Use water soluble or oil coolant.			
Model Number	Outside Diameter (mm)	Length of Cut (mm)	Spindle Speed (min ⁻¹)	Feed Rate (mm/min)	Milling Amount (mm)		Spindle Speed (min ⁻¹)	Feed Rate (mm/min)	Milling Amount (mm)		Spindle Speed (min ⁻¹)	Feed Rate (mm/min)	Milling Amount (mm)	
				Side Milling	a _p	a _e		Side Milling	a _p	a _e		Side Milling	a _p	a _e
2001-0020	0.1	0.2	30,000	50	0.15	0.006	30,000	50	0.15	0.006	30,000	45	0.15	0.005
2002-0040	0.2	0.4	30,000	150	0.3	0.012	30,000	140	0.3	0.012	30,000	105	0.3	0.01
2003-0060	0.3	0.6	30,000	230	0.45	0.018	30,000	185	0.45	0.018	30,000	165	0.45	0.015
2004-0080	0.4	0.8	30,000	315	0.6	0.024	30,000	240	0.6	0.02	30,000	225	0.6	0.016
2005-0080	0.5	0.8	27,000	490	0.75	0.03	24,000	360	0.75	0.025	24,000	315	0.75	0.02
2005-0100	0.5	1	27,000	400	0.75	0.03	24,000	300	0.75	0.025	24,000	260	0.75	0.02
2006-0100	0.6	1	24,000	600	1	0.036	20,000	450	1	0.03	20,000	400	1	0.024
2006-0120	0.6	1.2	24,000	500	1.2	0.036	20,000	360	1.2	0.03	20,000	315	1.2	0.024
2007-0140	0.7	1.4	22,500	500	1.4	0.042	17,800	360	1.4	0.035	17,800	315	1.4	0.028
2008-0160	0.8	1.6	21,000	500	1.6	0.048	16,700	360	1.6	0.04	16,700	315	1.6	0.032
2009-0180	0.9	1.8	19,500	500	1.8	0.054	15,600	360	1.8	0.045	15,600	315	1.8	0.036
2010-0200	1	2	18,000	600	1.5	0.09	14,500	450	1.5	0.09	14,500	500	1.5	0.06
2015-0300	1.5	3	16,000	900	2.25	0.135	13,000	600	2.25	0.135	13,000	750	2.25	0.09
2020-0400	2	4	12,000	900	3	0.18	10,000	600	3	0.18	10,000	750	3	0.12
2025-0500	2.5	5	10,200	900	3.75	0.23	8,400	600	3.75	0.23	8,400	750	3.75	0.15
2030-0600	3	6	8,500	900	4.5	0.27	6,800	600	4.5	0.27	6,800	750	4.5	0.18
2040-0800	4	8	7,200	675	6	0.6	5,700	500	6	0.6	5,700	575	6	0.4
2050-1000	5	10	6,000	750	7.5	0.75	4,800	550	7.5	0.75	4,800	650	7.5	0.5
2060-1200	6	12	5,000	800	9	0.9	4,000	600	9	0.9	4,000	650	9	0.6
2080-1600	8	16	3,500	700	12	1.2	2,700	525	12	1.2	2,400	600	12	0.8
2100-2000	10	20	2,300	600	15	1.5	1,900	450	15	1.5	1,400	500	15	1
2120-2400	12	24	1,850	550	18	1.8	1,550	400	18	1.8	1,250	450	18	1.2

WORK MATERIAL			PREHARDENED STEELS HPM / NAK (30~45HRC)				HARDENED STEELS SKD / SKT / STAVAX (45~55HRC)			
Model Number	Outside Diameter (mm)	Length of Cut (mm)	Spindle Speed (min ⁻¹)	Feed Rate (mm/min)	Milling Amount (mm)		Spindle Speed (min ⁻¹)	Feed Rate (mm/min)	Milling Amount (mm)	
				Side Milling	a _p	a _e		Side Milling	a _p	a _e
2001-0020	0.1	0.2	30,000	30	0.15	0.005	24,000	10	0.2	0.003
2002-0040	0.2	0.4	30,000	70	0.3	0.01	23,000	30	0.4	0.006
2003-0060	0.3	0.6	30,000	110	0.45	0.015	20,000	40	0.6	0.009
2004-0080	0.4	0.8	30,000	150	0.6	0.016	16,800	50	0.8	0.012
2005-0080	0.5	0.8	24,000	210	0.75	0.02	14,400	65	0.8	0.015
2005-0100	0.5	1	24,000	175	0.75	0.02	14,400	50	1	0.015
2006-0100	0.6	1	20,000	265	1	0.024	12,000	80	1	0.018
2006-0120	0.6	1.2	20,000	210	1.2	0.024	12,000	60	1.2	0.018
2007-0140	0.7	1.4	17,800	210	1.4	0.028	10,000	60	1.4	0.021
2008-0160	0.8	1.6	16,700	210	1.6	0.032	8,500	60	1.6	0.024
2009-0180	0.9	1.8	15,600	210	1.8	0.036	7,300	60	1.8	0.027
2010-0200	1	2	14,500	300	1.5	0.06	6,550	80	1.5	0.045
2015-0300	1.5	3	12,000	450	2.25	0.09	4,400	100	2.25	0.068
2020-0400	2	4	9,000	450	3	0.12	3,300	115	3	0.09
2025-0500	2.5	5	7,900	450	3.75	0.15	2,750	120	3.75	0.11
2030-0600	3	6	6,800	450	4.5	0.18	2,200	130	4.5	0.135
2040-0800	4	8	5,100	350	6	0.4	1,650	150	6	0.18
2050-1000	5	10	4,050	425	7.5	0.5	1,300	160	7.5	0.225
2060-1200	6	12	3,300	500	9	0.6	1,100	180	9	0.27
2080-1600	8	16	2,300	450	12	0.8	800	130	12	0.36
2100-2000	10	20	1,500	450	15	1	690	110	15	0.45
2120-2400	12	24	1,200	400	18	1.2	550	110	18	0.54

Milling Conditions for CSS

◆ 2.5D flute length type $2.5 < L/D \leq 3$

WORK MATERIAL			CARBON STEELS S45C / S50C Annealed Materials (~225HB)				ALLOY STEELS SK / SCM Annealed Materials (225~325HB)				STAINLESS STEELS SUS304 * Use water soluble or oil coolant.						
Model Number	Outside Diameter (mm)	Length of Cut (mm)	Spindle Speed (min ⁻¹)	Feed Rate (mm/min)		Milling Amount (mm)		Spindle Speed (min ⁻¹)	Feed Rate (mm/min)		Milling Amount (mm)		Spindle Speed (min ⁻¹)	Feed Rate (mm/min)		Milling Amount (mm)	
				Side Milling	a_p	a_e	Side Milling		a_p	a_e	Side Milling	a_p		a_e	Side Milling	a_p	a_e
2001-0025	0.1	0.25	30,000	40	0.2	0.005	30,000	40	0.2	0.005	30,000	25	0.2	0.004			
2002-0050	0.2	0.5	30,000	150	0.4	0.008	30,000	120	0.4	0.01	30,000	65	0.4	0.008			
2003-0075	0.3	0.75	30,000	230	0.6	0.012	30,000	160	0.6	0.015	30,000	100	0.6	0.012			
2004-0100	0.4	1	30,000	315	0.8	0.016	30,000	220	0.8	0.016	30,000	140	0.8	0.012			
2005-0125	0.5	1.25	27,000	400	1	0.02	24,000	260	1	0.02	24,000	155	1	0.015			
2006-0150	0.6	1.5	24,000	500	1.5	0.024	20,000	360	1.5	0.024	20,000	210	1.5	0.018			
2007-0175	0.7	1.75	22,500	500	1.75	0.028	17,800	360	1.75	0.028	17,800	210	1.75	0.021			
2008-0200	0.8	2	21,000	500	2	0.032	16,700	360	2	0.032	16,700	210	2	0.024			
2009-0225	0.9	2.25	19,500	500	2.25	0.036	15,600	360	2.25	0.036	15,600	210	2.25	0.027			
2010-0250	1	2.5	20,000	700	2.5	0.05	15,000	500	2.5	0.05	11,000	200	2.5	0.05			
2015-0375	1.5	3.75	12,800	710	3.75	0.075	10,000	500	3.75	0.075	7,000	210	3.75	0.075			
2020-0500	2	5	9,300	720	5	0.1	7,500	510	5	0.1	5,000	230	5	0.1			
2025-0625	2.5	6.25	7,600	725	6.25	0.13	6,250	515	6.25	0.13	4,100	250	6.25	0.13			
2030-0750	3	7.5	5,900	730	7.5	0.15	5,000	520	7.5	0.15	3,200	275	7.5	0.15			
2040-1000	4	10	4,200	740	10	0.4	3,750	520	10	0.4	2,250	300	10	0.2			
2050-1250	5	12.5	3,200	750	12.5	0.5	3,000	530	12.5	0.5	1,700	330	12.5	0.25			
2060-1500	6	15	2,500	750	15	0.6	2,500	530	15	0.6	1,350	350	15	0.3			
2070-1750	7	17.5	2,270	700	17.5	0.7	2,270	495	17.5	0.7	1,150	350	17.5	0.35			
2080-2000	8	20	2,100	660	20	0.8	2,100	470	20	0.8	1,000	350	20	0.4			
2090-2250	9	22.5	1,935	615	22.5	0.9	1,935	440	22.5	0.9	895	350	22.5	0.45			
2100-2500	10	25	1,800	580	25	1	1,800	410	25	1	810	350	25	0.5			
2110-2750	11	27.5	1,635	545	27.5	1.1	1,635	375	27.5	1.1	735	335	27.5	0.55			
2120-3000	12	30	1,500	520	30	1.2	1,500	350	30	1.2	670	320	30	0.6			

WORK MATERIAL			PREHARDENED STEELS HPM / NAK (30~45HRC)				HARDENED STEELS SKD / SKT / STAVAX (45~55HRC)					
Model Number	Outside Diameter (mm)	Length of Cut (mm)	Spindle Speed (min ⁻¹)	Feed Rate (mm/min)		Milling Amount (mm)		Spindle Speed (min ⁻¹)	Feed Rate (mm/min)		Milling Amount (mm)	
				Side Milling	a_p	a_e	Side Milling		a_p	a_e		
2001-0025	0.1	0.25	30,000	25	0.2	0.004	24,000	10	0.25	0.002		
2002-0050	0.2	0.5	30,000	65	0.4	0.008	23,000	25	0.5	0.004		
2003-0075	0.3	0.75	30,000	100	0.6	0.012	20,000	35	0.75	0.006		
2004-0100	0.4	1	30,000	140	0.8	0.012	16,800	45	1	0.008		
2005-0125	0.5	1.25	24,000	155	1	0.015	14,400	50	1.25	0.01		
2006-0150	0.6	1.5	20,000	210	1.5	0.018	12,000	60	1.5	0.012		
2007-0175	0.7	1.75	17,800	210	1.75	0.021	10,000	60	1.75	0.014		
2008-0200	0.8	2	16,700	210	2	0.024	8,500	60	2	0.016		
2009-0225	0.9	2.25	15,600	210	2.25	0.027	7,300	60	2.25	0.018		
2010-0250	1	2.5	11,000	200	2.5	0.05	5,500	60	2.5	0.05		
2015-0375	1.5	3.75	7,500	210	3.75	0.075	3,750	65	3.75	0.075		
2020-0500	2	5	5,700	230	5	0.1	2,850	70	5	0.1		
2025-0625	2.5	6.25	4,800	240	6.25	0.13	2,400	70	6.25	0.13		
2030-0750	3	7.5	3,900	250	7.5	0.15	1,950	75	7.5	0.15		
2040-1000	4	10	2,900	270	10	0.3	1,450	80	10	0.3		
2050-1250	5	12.5	2,400	290	12.5	0.375	1,200	90	12.5	0.375		
2060-1500	6	15	2,000	300	15	0.45	1,000	100	15	0.45		
2070-1750	7	17.5	1,630	285	17.5	0.525	815	85	17.5	0.525		
2080-2000	8	20	1,350	270	20	0.6	675	70	20	0.6		
2090-2250	9	22.5	1,135	255	22.5	0.675	565	60	22.5	0.675		
2100-2500	10	25	960	240	25	0.75	480	50	25	0.75		
2110-2750	11	27.5	845	220	27.5	0.825	425	45	27.5	0.825		
2120-3000	12	30	750	200	30	0.9	375	40	30	0.9		

Ø3mm Shank
V SeriesUDC-PCD
SeriesCBN
Series

Square

Long Neck
Square

Radius

Long Neck
RadiusTaper Neck
RadiusBall / Long
Shank BallLong Neck
BallTaper Neck
Ball

Taper

Barrel

Spiral
V Cutter

Drill

Technical Data

Milling Conditions for CSS

◆ 3D flute length type L/D=3

WORK MATERIAL			CARBON STEELS S45C / S50C Annealed Materials (~225HB)				ALLOY STEELS SK / SCM Annealed Materials (225~325HB)				STAINLESS STEELS SUS304 * Use water soluble or oil coolant.						
Model Number	Outside Diameter (mm)	Length of Cut (mm)	Spindle Speed (min ⁻¹)	Feed Rate (mm/min)		Milling Amount (mm)		Spindle Speed (min ⁻¹)	Feed Rate (mm/min)		Milling Amount (mm)		Spindle Speed (min ⁻¹)	Feed Rate (mm/min)		Milling Amount (mm)	
				Side Milling	a _p	a _e	Side Milling		a _p	a _e	Side Milling	a _p		a _e			
2001-0030	0.1	0.3	30,000	30	0.25	0.005	30,000	30	0.25	0.005	30,000	20	0.25	0.004			
2002-0060	0.2	0.6	30,000	110	0.5	0.008	30,000	85	0.5	0.01	30,000	50	0.5	0.008			
2003-0090	0.3	0.9	30,000	180	0.75	0.012	30,000	135	0.75	0.015	30,000	80	0.75	0.012			
2004-0120	0.4	1.2	30,000	250	1	0.016	30,000	170	1	0.016	30,000	100	1	0.012			
2005-0150	0.5	1.5	27,000	320	1.25	0.02	24,000	200	1.25	0.02	24,000	125	1.25	0.015			
2006-0180	0.6	1.8	24,000	400	1.8	0.024	20,000	280	1.8	0.024	20,000	170	1.8	0.018			
2007-0210	0.7	2.1	22,500	400	2.1	0.028	17,800	280	2.1	0.028	17,800	170	2.1	0.021			
2008-0240	0.8	2.4	21,000	400	2.4	0.032	16,700	280	2.4	0.032	16,700	170	2.4	0.024			
2009-0270	0.9	2.7	19,500	400	2.7	0.036	15,600	280	2.7	0.036	15,600	170	2.7	0.027			
2010-0300	1	3	20,000	700	3	0.05	15,000	500	3	0.05	11,000	200	3	0.05			
2015-0450	1.5	4.5	12,800	710	4.5	0.075	10,000	500	4.5	0.075	7,000	210	4.5	0.075			
2020-0600	2	6	9,300	720	6	0.1	7,500	510	6	0.1	5,000	230	6	0.1			
2025-0750	2.5	7.5	7,600	725	7.5	0.13	6,250	515	7.5	0.13	4,100	250	7.5	0.13			
2030-0900	3	9	5,900	730	9	0.15	5,000	520	9	0.15	3,200	275	9	0.15			
2040-1200	4	12	4,200	740	12	0.4	3,750	520	12	0.4	2,250	300	12	0.2			
2050-1500	5	15	3,200	750	15	0.5	3,000	530	15	0.5	1,700	330	15	0.25			
2060-1800	6	18	2,500	750	18	0.6	2,500	530	18	0.6	1,350	350	18	0.3			
2070-2100	7	21	2,270	700	21	0.7	2,270	495	21	0.7	1,150	350	21	0.35			
2080-2400	8	24	2,100	660	24	0.8	2,100	470	24	0.8	1,000	350	24	0.4			
2090-2700	9	27	1,935	615	27	0.9	1,935	440	27	0.9	895	350	27	0.45			
2100-3000	10	30	1,800	580	30	1	1,800	410	30	1	810	350	30	0.5			
2110-3300	11	33	1,635	545	33	1.1	1,635	375	33	1.1	735	335	33	0.55			
2120-3600	12	36	1,500	520	36	1.2	1,500	350	36	1.2	670	320	36	0.6			

WORK MATERIAL			PREHARDENED STEELS HPM / NAK (30~45HRC)				HARDENED STEELS SKD / SKT / STAVAX (45~55HRC)					
Model Number	Outside Diameter (mm)	Length of Cut (mm)	Spindle Speed (min ⁻¹)	Feed Rate (mm/min)		Milling Amount (mm)		Spindle Speed (min ⁻¹)	Feed Rate (mm/min)		Milling Amount (mm)	
				Side Milling	a _p	a _e	Side Milling		a _p	a _e		
2001-0030	0.1	0.3	30,000	20	0.25	0.004	24,000	10	0.3	0.002		
2002-0060	0.2	0.6	30,000	50	0.5	0.008	23,000	20	0.6	0.004		
2003-0090	0.3	0.9	30,000	80	0.75	0.012	20,000	35	0.9	0.003		
2004-0120	0.4	1.2	30,000	100	1	0.012	16,800	40	1.2	0.004		
2005-0150	0.5	1.5	24,000	125	1.25	0.015	14,400	50	1.5	0.005		
2006-0180	0.6	1.8	20,000	170	1.8	0.018	12,000	60	1.8	0.006		
2007-0210	0.7	2.1	17,800	170	2.1	0.021	10,000	60	2.1	0.007		
2008-0240	0.8	2.4	16,700	170	2.4	0.024	8,500	60	2.4	0.008		
2009-0270	0.9	2.7	15,600	170	2.7	0.027	7,300	60	2.7	0.009		
2010-0300	1	3	11,000	200	3	0.05	5,500	60	3	0.05		
2015-0450	1.5	4.5	7,500	210	4.5	0.075	3,750	65	4.5	0.075		
2020-0600	2	6	5,700	230	6	0.1	2,850	70	6	0.1		
2025-0750	2.5	7.5	4,800	240	7.5	0.13	2,400	70	7.5	0.13		
2030-0900	3	9	3,900	250	9	0.15	1,950	75	9	0.15		
2040-1200	4	12	2,900	270	12	0.3	1,450	80	12	0.3		
2050-1500	5	15	2,400	290	15	0.375	1,200	90	15	0.375		
2060-1800	6	18	2,000	300	18	0.45	1,000	100	18	0.45		
2070-2100	7	21	1,630	285	21	0.525	815	85	21	0.525		
2080-2400	8	24	1,350	270	24	0.6	675	70	24	0.6		
2090-2700	9	27	1,135	255	27	0.675	565	60	27	0.675		
2100-3000	10	30	960	240	30	0.75	480	50	30	0.75		
2110-3300	11	33	845	220	33	0.825	425	45	33	0.825		
2120-3600	12	36	750	200	36	0.9	375	40	36	0.9		

Milling Conditions for CSS

Note:

- Decrease both spindle speed and feed rate proportionally in case of chattering.
- These milling parameters are calculated based on the shortest overhang length. Longer overhangs may require an adjustment to the milling parameters.
- Reduce the milling amount and feed rate in accordance with required milling precision.
- Recommend water soluble or oil coolant.
- Recommend oil coolant for Titanium Alloys and Heat Resistant Alloys.

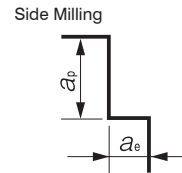
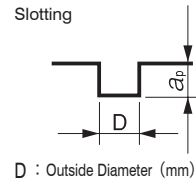

Unique Cross Section design

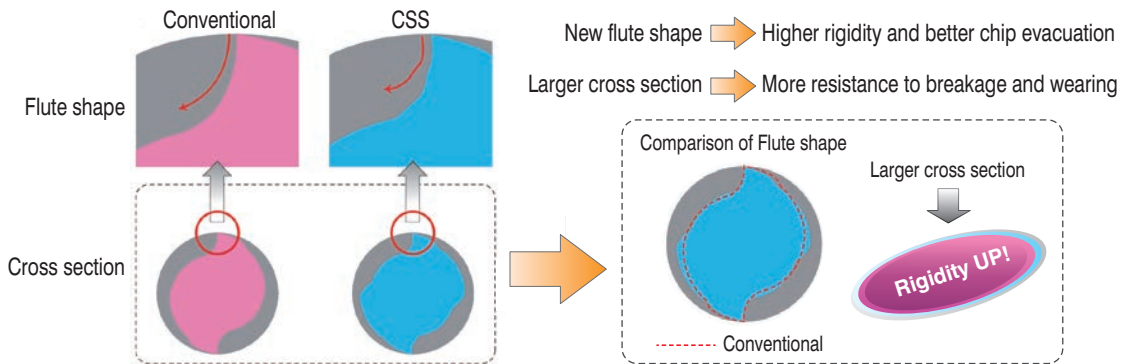

Milling Example: Slotting Comparison

Tool	$\phi 6 \times L12$ mm
Spindle Speed	1,100 min^{-1}
Feed Rate	40 mm/min
a_p	1.8 mm
Coolant	Air Blow (Through Spindle)
Cycle Time	28 min

STAVAX (53HRC)

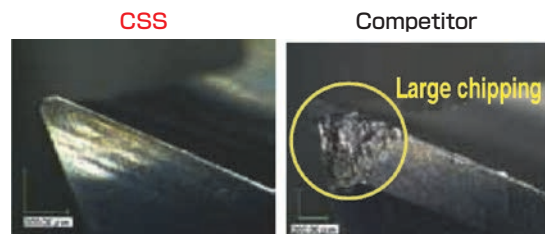

$\phi 3$ mm Shank
V Series

UDC-PCD
Series

CBN
Series

Square

Square

Long Neck
Square

Radius

Radius

Long Neck
Radius

Taper Neck
Radius

Ball

Ball / Long
Shank Ball

Long Neck
Ball

Taper Neck
Ball

Taper

Taper

Barrel

Spiral
V Cutter

Drill

Technical Data

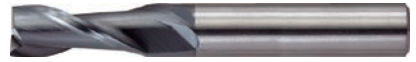

Size $\phi 0.1 \sim \phi 20$

C-CES2000



Material Applications (★ Highly Recommended ● Recommended ○ Suggested)

Work Material																	
Carbon Steels S45C S55C	Alloy Steels SK / SCM SUS	Prehardened Steels NAK HPM	Hardened Steels					Cast Iron	Aluminum Alloys	Graphite	Copper	Plastics	Glass Filled Plastics	Titanium Alloys	Heat Resistant Alloys	Cemented Carbide	Hard Brittle (Non-Metallic) Materials
			~50HRC	~55HRC	~60HRC	~65HRC	~70HRC										
●	●	●	●	○				○			●			○	○		

- 3mm Shank V Series
- UDC-PCD Series
- CBN Series
- Square
- Long Neck Square
- Radius
- Long Neck Radius
- Taper Neck Radius
- Ball / Long Shank Ball
- Long Neck Ball
- Taper Neck Ball
- Taper
- Barrel
- Spiral V Cutter
- Drill
- Technical Data

Features

Broad application range from Copper and Carbon Steels up to Hardened Steels (55HRC). Excellent performance/quality to price ratio. Refer to page 194 for 4 flute C-CES.

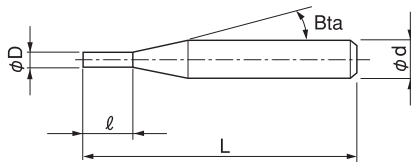

The shank taper angle shown is not an exact value and to avoid contact with the work piece, we recommend the user controls the precise value of this angle. Shank taper angle should not make contact with the work piece.

Total 207 models

Unit (mm)

Model Number	Outside Diameter ϕD	Length of Cut ℓ	Shank Taper Angle Bta	Overall Length L	Shank Diameter ϕd	Suggested Retail Price \yen
C-CES 2001-0015	0.1	0.15	16°	45	4	7,800
C-CES 2001-0020		0.2		45	4	7,800
C-CES 2001-0030		0.3		45	4	7,800
C-CES 2002-0030	0.2	0.3	16°	45	4	4,680
C-CES 2002		0.4		38	3	4,680
C-CES 2002-0040		0.4		45	4	4,680
C-CES 2002-0050		0.5		45	4	4,680
C-CES 2002-0060		0.6		45	4	4,680
C-CES 2002-0080		0.8		45	4	7,930

Next Page ➡

Unit (mm)

Model Number	Outside Diameter ϕD	Length of Cut ℓ	Shank Taper Angle Bta	Overall Length L	Shank Diameter ϕd	Suggested Retail Price ¥
C-CES 2003-0045	0.3	0.45	16°	45	4	4,080
C-CES 2003		0.6		38	3	4,080
C-CES 2003-0060		0.6		45	4	4,080
C-CES 2003-0075		0.75		45	4	4,080
C-CES 2003-0090		0.9		45	4	4,080
C-CES 2003-0120		1.2		45	4	6,120
C-CES 2004-0060	0.4	0.6	16°	45	4	4,560
C-CES 2004		0.8		38	3	4,560
C-CES 2004-0080		0.8		45	4	4,560
C-CES 2004-0100		1		45	4	4,560
C-CES 2004-0120		1.2		45	4	4,560
C-CES 2004-0160		1.6		45	4	6,120
C-CES 2005-0075	0.5	0.75	16°	45	4	2,280
C-CES 2005		0.8		38	3	2,280
C-CES 2005-0100		1		45	4	2,280
C-CES 2005-0125		1.25		45	4	2,280
C-CES 2005-0150		1.5		45	4	2,280
C-CES 2005-0200		2		45	4	3,840
C-CES 2006-0090	0.6	0.9	16°	45	4	3,480
C-CES 2006		1		38	3	3,480
C-CES 2006-0120		1.2		45	4	3,480
C-CES 2006-0150		1.5		45	4	3,480
C-CES 2006-0180		1.8		45	4	3,480
C-CES 2006-0240		2.4		45	4	3,480
C-CES 2007	0.7	1	16°	38	3	3,840
C-CES 2007-0140		1.4		45	4	3,840
C-CES 2007-0175		1.75		45	4	3,840
C-CES 2007-0210		2.1		45	4	3,840
C-CES 2007-0280		2.8		45	4	3,840
C-CES 2008		0.8		1.2	16°	38
C-CES 2008-0120	1.2		45	4		2,280
C-CES 2008-0160	1.6		45	4		2,280
C-CES 2008-0200	2		45	4		2,280
C-CES 2008-0240	2.4		45	4		2,280
C-CES 2008-0320	3.2		45	4		3,840
C-CES 2009	0.9	1.2	16°	38	3	3,840
C-CES 2009-0180		1.8		45	4	3,840
C-CES 2009-0225		2.25		45	4	3,840
C-CES 2009-0270		2.7		45	4	3,840
C-CES 2009-0360		3.6		45	4	3,840

$\phi 3\text{mm}$ Shank
V Series

UDC-PCD
Series

CBN
Series

Square

Long Neck
Square

Radius

Long Neck
Radius

Taper Neck
Radius

Ball / Long
Shank Ball

Long Neck
Ball

Taper Neck
Ball

Taper

Barrel

Spiral
V Cutter

Drill

Technical Data

Next Page →

Unit (mm)

Model Number	Outside Diameter ϕD	Length of Cut ℓ	Shank Taper Angle $B\alpha$	Overall Length L	Shank Diameter ϕd	Suggested Retail Price ¥
C-CES 2010-0150	1	1.5	16°	45	4	2,040
C-CES 2010-0200		2		45	4	2,040
C-CES 2010		2.5		45	4	2,040
C-CES 2010-0300		3		45	4	2,040
C-CES 2010-0400		4		45	4	3,480
C-CES 2011	1.1	2.5	16°	45	4	4,320
C-CES 2012-0180	1.2	1.8	16°	45	4	2,280
C-CES 2012-0240		2.4		45	4	2,280
C-CES 2012-0300		3		45	4	2,280
C-CES 2012-0360		3.6		45	4	2,280
C-CES 2012		4		45	4	2,280
C-CES 2012-0480		4.8		45	4	3,480
C-CES 2013	1.3	4	16°	45	4	4,320
C-CES 2014	1.4	4	16°	45	4	4,320
C-CES 2015-0225	1.5	2.25	16°	45	4	2,040
C-CES 2015-0300		3		45	4	2,040
C-CES 2015-0375		3.75		45	4	2,040
C-CES 2015		4		45	4	2,040
C-CES 2015-0450		4.5		45	4	2,040
C-CES 2015-0600		6		45	4	3,480
C-CES 2016	1.6	5	16°	45	4	4,320
C-CES 2017	1.7	5	16°	45	4	4,320
C-CES 2018-0270	1.8	2.7	16°	45	4	2,280
C-CES 2018-0360		3.6		45	4	2,280
C-CES 2018-0450		4.5		45	4	2,280
C-CES 2018		5		45	4	2,280
C-CES 2018-0540		5.4		45	4	2,280
C-CES 2018-0720		7.2		45	4	4,200
C-CES 2019	1.9	5	16°	45	4	4,440
C-CES 2020-0300	2	3	16°	45	4	2,040
C-CES 2020-0400		4		45	4	2,040
C-CES 2020-0500		5		45	4	2,040
C-CES 2020		6		45	4	2,040
C-CES 2020-0800		8		45	4	3,480
C-CES 2021	2.1	6	16°	45	4	4,320
C-CES 2022	2.2	6	16°	45	4	4,320
C-CES 2023	2.3	6	16°	45	4	4,320
C-CES 2024	2.4	8	16°	45	4	4,320

φ3mm Shank V Series

UDC-PCD Series

CBN Series

Square
Long Neck Square

Radius

Radius
Long Neck Radius
Taper Neck Radius

Ball / Long Shank Ball

Ball
Long Neck Ball
Taper Neck Ball

Taper

Barrel

Spiral V Cutter

Drill

Technical Data

Unit (mm)

Model Number	Outside Diameter ϕD	Length of Cut ℓ	Shank Taper Angle Bta	Overall Length L	Shank Diameter ϕd	Suggested Retail Price ¥
C-CES 2025-0375	2.5	3.75	16°	45	4	2,040
C-CES 2025-0500		5		45	4	2,040
C-CES 2025-0625		6.25		45	4	2,040
C-CES 2025-0750		7.5		45	4	2,040
C-CES 2025		8		45	4	2,040
C-CES 2025-1000		10		50	4	3,480
C-CES 2026	2.6	8	16°	45	6	5,520
C-CES 2027	2.7	8	16°	45	6	5,520
C-CES 2028	2.8	8	16°	45	6	5,520
C-CES 2029	2.9	8	16°	45	6	5,520
C-CES 2030-0450	3	4.5	16°	45	6	2,640
C-CES 2030-0600		6		45	6	2,640
C-CES 2030-0750		7.5		45	6	2,640
C-CES 2030		8		45	6	2,640
C-CES 2030-0900		9		45	6	2,640
C-CES 2030-1200		12		50	6	4,320
C-CES 2031	3.1	10	16°	45	6	5,760
C-CES 2032	3.2	10	16°	45	6	5,760
C-CES 2033	3.3	10	16°	45	6	5,760
C-CES 2034	3.4	10	16°	45	6	5,760
C-CES 2035	3.5	10	16°	45	6	4,680
C-CES 2036	3.6	10	16°	45	6	5,760
C-CES 2037	3.7	10	16°	45	6	5,760
C-CES 2038	3.8	11	16°	45	6	5,760
C-CES 2039	3.9	11	16°	45	6	5,760
C-CES 2040-0600	4	6	16°	50	6	2,880
C-CES 2040-0800		8		50	6	2,880
C-CES 2040-1000		10		50	6	2,880
C-CES 2040		11		45	6	2,880
C-CES 2040-1200		12		50	6	2,880
C-CES 2040-1600		16		60	6	4,680
C-CES 2041	4.1	11	16°	45	6	5,760
C-CES 2042	4.2	11	16°	45	6	5,760
C-CES 2043	4.3	11	16°	45	6	5,760
C-CES 2044	4.4	11	16°	45	6	5,760
C-CES 2045	4.5	11	16°	45	6	5,400
C-CES 2046	4.6	11	16°	45	6	6,600
C-CES 2047	4.7	11	16°	45	6	6,600
C-CES 2048	4.8	13	16°	50	6	6,600
C-CES 2049	4.9	13	16°	50	6	6,600

3mm Shank
V Series

UDC-PCD
Series

CBN
Series

Square

Long Neck
Square

Radius

Long Neck
Radius

Taper Neck
Radius

Ball / Long
Shank Ball

Long Neck
Ball

Taper Neck
Ball

Taper

Barrel

Spiral
V Cutter

Drill

Technical Data

Next Page ➡

Unit (mm)

Model Number	Outside Diameter ϕD	Length of Cut ℓ	Shank Taper Angle Bta	Overall Length L	Shank Diameter ϕd	Suggested Retail Price ¥
C-CES 2050-0750	5	7.5	16°	50	6	3,120
C-CES 2050-1000		10		50	6	3,120
C-CES 2050-1250		12.5		50	6	3,120
C-CES 2050		13		50	6	3,120
C-CES 2050-1500		15		50	6	3,120
C-CES 2050-2000		20		60	6	5,280
C-CES 2051	5.1	13	16°	50	6	6,600
C-CES 2052	5.2	13	16°	50	6	6,600
C-CES 2053	5.3	13	16°	50	6	6,600
C-CES 2054	5.4	13	16°	50	6	6,600
C-CES 2055	5.5	13	16°	50	6	5,640
C-CES 2056	5.6	13	16°	50	6	5,640
C-CES 2057	5.7	13	16°	50	6	5,640
C-CES 2058	5.8	13	16°	50	6	5,640
C-CES 2059	5.9	13	16°	50	6	5,640
C-CES 2060-0900	6	9	—	50	6	3,360
C-CES 2060-1200		12		50	6	3,360
C-CES 2060		13		50	6	3,360
C-CES 2060-1500		15		50	6	3,360
C-CES 2060-1800		18		50	6	3,360
C-CES 2060-2400		24		60	6	5,400
C-CES 2061	6.1	16	16°	60	8	10,340
C-CES 2062	6.2	16	16°	60	8	10,340
C-CES 2063	6.3	16	16°	60	8	10,340
C-CES 2064	6.4	16	16°	60	8	10,340
C-CES 2065	6.5	16	16°	60	8	9,280
C-CES 2066	6.6	16	16°	60	8	10,340
C-CES 2067	6.7	16	16°	60	8	10,340
C-CES 2068	6.8	16	16°	60	8	10,340
C-CES 2069	6.9	16	16°	60	8	10,340
C-CES 2070	7	16	16°	60	8	8,700
C-CES 2071	7.1	16	16°	60	8	10,340
C-CES 2072	7.2	16	16°	60	8	10,340
C-CES 2073	7.3	16	16°	60	8	10,340
C-CES 2074	7.4	16	16°	60	8	10,340
C-CES 2075	7.5	16	16°	60	8	10,360
C-CES 2076	7.6	19	16°	60	8	11,550
C-CES 2077	7.7	19	16°	60	8	11,550
C-CES 2078	7.8	19	16°	60	8	11,550
C-CES 2079	7.9	19	16°	60	8	11,550

Next Page ➡

Unit (mm)

Model Number	Outside Diameter ϕD	Length of Cut ℓ	Shank Taper Angle Bta	Overall Length L	Shank Diameter ϕd	Suggested Retail Price ¥
C-CES 2080-1600	8	16	—	60	8	6,320
C-CES 2080		19		60	8	6,320
C-CES 2080-2000		20		60	8	6,320
C-CES 2080-2400		24		80	8	6,320
C-CES 2080-3200		32		80	8	11,520
C-CES 2081	8.1	19	16°	70	10	13,860
C-CES 2082	8.2	19	16°	70	10	13,860
C-CES 2083	8.3	19	16°	70	10	13,860
C-CES 2084	8.4	19	16°	70	10	13,860
C-CES 2085	8.5	19	16°	70	10	12,420
C-CES 2086	8.6	19	16°	70	10	13,860
C-CES 2087	8.7	19	16°	70	10	13,860
C-CES 2088	8.8	19	16°	70	10	13,860
C-CES 2089	8.9	19	16°	70	10	13,860
C-CES 2090	9	19	16°	70	10	12,420
C-CES 2091	9.1	19	16°	70	10	13,860
C-CES 2092	9.2	19	16°	70	10	13,860
C-CES 2093	9.3	19	16°	70	10	13,860
C-CES 2094	9.4	19	16°	70	10	13,860
C-CES 2095	9.5	19	16°	70	10	12,870
C-CES 2096	9.6	22	16°	70	10	14,300
C-CES 2097	9.7	22	16°	70	10	14,300
C-CES 2098	9.8	22	16°	70	10	14,300
C-CES 2099	9.9	22	16°	70	10	14,300
C-CES 2100-2000	10	20	—	70	10	7,580
C-CES 2100		22		70	10	7,580
C-CES 2100-2500		25		70	10	7,580
C-CES 2100-3000		30		80	10	7,580
C-CES 2100-4000		40		90	10	12,600
C-CES 2105	10.5	22	16°	75	12	18,920
C-CES 2110	11	22	16°	75	12	17,160
C-CES 2115	11.5	22	16°	75	12	19,580
C-CES 2120-2400	12	24	—	75	12	11,170
C-CES 2120		26		75	12	11,170
C-CES 2120-3000		30		75	12	11,170
C-CES 2120-3600		36		90	12	11,170
C-CES 2120-4800		48		100	12	22,490
C-CES 2160	16	32	—	110	16	35,530
C-CES 2180	18	32	16°	110	20	55,880
C-CES 2200	20	38	—	110	20	60,500

$\phi 3$ mm Shank
V Series

UDC-PCD
Series

CBN
Series

Square

Long Neck
Square

Radius

Long Neck
Radius

Taper Neck
Radius

Ball / Long
Shank Ball

Long Neck
Ball

Taper Neck
Ball

Taper

Barrel

Spiral
V Cutter

Drill

Technical Data

Milling Conditions for C-CES (2 Flutes)

WORK MATERIAL			CARBON STEELS S45C / S50C (~225HB)					ALLOY STEELS SK / SCM / SUS (225~325HB)						
Model Number	Outside Diameter (mm)	Length of Cut (mm)	Spindle Speed (min ⁻¹)	Feed Rate (mm/min)	Slotting		Side Milling		Spindle Speed (min ⁻¹)	Feed Rate (mm/min)	Slotting		Side Milling	
					a _p (mm)	a _e (mm)	a _p (mm)	a _e (mm)			a _p (mm)	a _e (mm)		
2001	0.1	0.15	30,000	30	0.01	0.15	0.01	30,000	30	0.01	0.15	0.01	0.15	0.01
		0.2	30,000	30	0.01	0.15	0.01	30,000	30	0.01	0.15	0.01	0.15	0.01
		0.3	30,000	30	0.005	0.25	0.005	30,000	30	0.005	0.25	0.005	0.25	0.005
2002	0.2	0.3	30,000	85	0.02	0.3	0.02	30,000	85	0.02	0.3	0.02	0.3	0.02
		0.4	30,000	85	0.02	0.3	0.02	30,000	85	0.02	0.3	0.02	0.3	0.02
		0.5	30,000	85	0.014	0.4	0.014	30,000	85	0.014	0.4	0.014	0.4	0.014
		0.6	30,000	85	0.01	0.5	0.01	30,000	85	0.01	0.5	0.01	0.5	0.01
		0.8	30,000	85	0.004	0.7	0.004	30,000	85	0.004	0.7	0.004	0.7	0.004
2003	0.3	0.45	30,000	110	0.03	0.45	0.03	30,000	110	0.03	0.45	0.03	0.45	0.03
		0.6	30,000	110	0.03	0.45	0.03	30,000	110	0.03	0.45	0.03	0.45	0.03
		0.75	30,000	110	0.021	0.6	0.021	30,000	110	0.021	0.6	0.021	0.6	0.021
		0.9	30,000	110	0.015	0.75	0.015	30,000	110	0.015	0.75	0.015	0.75	0.015
2004	0.4	1.2	30,000	110	0.006	1.05	0.006	30,000	110	0.006	1.05	0.006	1.05	0.006
		0.6	30,000	120	0.04	0.6	0.04	30,000	120	0.04	0.6	0.04	0.6	0.04
		0.8	30,000	120	0.04	0.6	0.04	30,000	120	0.04	0.6	0.04	0.6	0.04
		1	30,000	120	0.028	0.8	0.028	30,000	120	0.028	0.8	0.028	0.8	0.028
		1.2	30,000	120	0.02	1	0.02	30,000	120	0.02	1	0.02	1	0.02
2005	0.5	1.6	30,000	120	0.008	1.4	0.008	30,000	120	0.008	1.4	0.008	1.4	0.008
		0.75	30,000	120	0.05	0.75	0.05	29,000	120	0.05	0.75	0.05	0.75	0.05
		0.8	30,000	120	0.05	0.75	0.05	29,000	120	0.05	0.75	0.05	0.75	0.05
		1	30,000	120	0.05	0.75	0.05	29,000	120	0.05	0.75	0.05	0.75	0.05
		1.25	30,000	120	0.035	1	0.035	29,000	120	0.035	1	0.035	1	0.035
2006	0.6	1.5	30,000	120	0.025	1.25	0.025	29,000	120	0.025	1.25	0.025	1.25	0.025
		2	30,000	120	0.01	1.75	0.01	29,000	120	0.01	1.75	0.01	1.75	0.01
		0.9	30,000	120	0.06	0.9	0.06	24,000	120	0.06	0.9	0.06	0.9	0.06
		1	30,000	120	0.06	0.9	0.06	24,000	120	0.06	0.9	0.06	0.9	0.06
		1.2	30,000	120	0.06	0.9	0.06	24,000	120	0.06	0.9	0.06	0.9	0.06
2007	0.7	1.5	30,000	120	0.042	1.2	0.042	24,000	120	0.042	1.2	0.042	1.2	0.042
		1.8	30,000	120	0.03	1.5	0.03	24,000	120	0.03	1.5	0.03	1.5	0.03
		2.4	30,000	120	0.012	2.1	0.012	24,000	120	0.012	2.1	0.012	2.1	0.012
		1	27,500	120	0.07	1.05	0.07	21,000	120	0.07	1.05	0.07	1.05	0.07
		1.4	27,500	120	0.07	1.05	0.07	21,000	120	0.07	1.05	0.07	1.05	0.07
2008	0.8	1.75	27,500	120	0.049	1.4	0.049	21,000	120	0.049	1.4	0.049	1.4	0.049
		2.1	27,500	120	0.035	1.75	0.035	21,000	120	0.035	1.75	0.035	1.75	0.035
		2.8	27,500	120	0.014	2.45	0.014	21,000	120	0.014	2.45	0.014	2.45	0.014
		1.2	24,000	120	0.08	1.2	0.08	19,000	120	0.08	1.2	0.08	1.2	0.08
		1.6	24,000	120	0.08	1.2	0.08	19,000	120	0.08	1.2	0.08	1.2	0.08
2009	0.9	2	24,000	120	0.056	1.6	0.056	19,000	120	0.056	1.6	0.056	1.6	0.056
		2.4	24,000	120	0.04	2	0.04	19,000	120	0.04	2	0.04	2	0.04
		3.2	24,000	120	0.016	2.8	0.016	19,000	120	0.016	2.8	0.016	2.8	0.016
		1.2	21,500	125	0.09	1.35	0.09	16,500	120	0.09	1.35	0.09	1.35	0.09
		1.8	21,500	125	0.09	1.35	0.09	16,500	120	0.09	1.35	0.09	1.35	0.09
2010	1	2.25	21,500	125	0.063	1.8	0.063	16,500	120	0.063	1.8	0.063	1.8	0.063
		2.7	21,500	125	0.045	2.25	0.045	16,500	120	0.045	2.25	0.045	2.25	0.045
		3.6	21,500	125	0.018	3.15	0.018	16,500	120	0.018	3.15	0.018	3.15	0.018
		1.5	20,000	125	0.25	1.5	0.1	15,000	120	0.25	1.5	0.1	1.5	0.1
		2	20,000	125	0.25	1.5	0.1	15,000	120	0.25	1.5	0.1	1.5	0.1
2012	1.2	2.5	20,000	125	0.2	2	0.07	15,000	120	0.2	2	0.07	2	0.07
		3	20,000	125	0.125	2.5	0.05	15,000	120	0.125	2.5	0.05	2.5	0.05
		4	20,000	125	0.075	3.5	0.02	15,000	120	0.075	3.5	0.02	3.5	0.02
		1.8	16,700	130	0.3	1.8	0.12	12,500	120	0.3	1.8	0.12	1.8	0.12
		2.4	16,700	130	0.3	1.8	0.12	12,500	120	0.3	1.8	0.12	1.8	0.12
2015	1.5	3	16,700	130	0.24	2.4	0.084	12,500	120	0.24	2.4	0.084	2.4	0.084
		3.6	16,700	130	0.15	3	0.06	12,500	120	0.15	3	0.06	3	0.06
		4	16,700	130	0.09	4	0.024	12,500	120	0.09	4	0.024	4	0.024
		4.8	16,700	130	0.09	4.2	0.024	12,500	120	0.09	4.2	0.024	4.2	0.024
		2.25	13,500	130	0.375	2.25	0.15	10,000	120	0.375	2.25	0.15	2.25	0.15
2015	1.5	3	13,500	130	0.375	2.25	0.15	10,000	120	0.375	2.25	0.15	2.25	0.15
		3.75	13,500	130	0.3	3	0.105	10,000	120	0.3	3	0.105	3	0.105
		4	13,500	130	0.1875	3.75	0.075	10,000	120	0.1875	3.75	0.075	3.75	0.075
		4.5	13,500	130	0.1875	3.75	0.075	10,000	120	0.1875	3.75	0.075	3.75	0.075
		6	13,500	130	0.1125	5.25	0.03	10,000	120	0.1125	5.25	0.03	5.25	0.03

- φ3mm Shank V Series
- UDC-PCD Series
- CBN Series
- Square
- Long Neck Square
- Radius
- Long Neck Radius
- Taper Neck Radius
- Ball / Long Shank Ball
- Long Neck Ball
- Taper Neck Ball
- Taper
- Barrel
- Spiral V Cutter
- Drill
- Technical Data

Milling Conditions for C-CES (2 Flutes)

WORK MATERIAL			PREHARDENED STEELS / HARDENED STEELS NAK / SKD (30~45HRC)					HARDENED STEELS SKD / SKT (45~55HRC)				
Model Number	Outside Diameter (mm)	Length of Cut (mm)	Spindle Speed (min ⁻¹)	Feed Rate (mm/min)	Slotting			Spindle Speed (min ⁻¹)	Feed Rate (mm/min)	Side Milling		
					a _p (mm)	a _p (mm)	a _e (mm)			a _p (mm)	a _p (mm)	a _e (mm)
2001	0.1	0.15	30,000	15	0.01	0.15	0.01	30,000	10	0.002	0.1	0.005
		0.2	30,000	15	0.01	0.15	0.01	30,000	10	0.002	0.1	0.005
		0.3	30,000	15	0.005	0.25	0.005	30,000	10	0.001	0.2	0.002
2002	0.2	0.3	30,000	30	0.02	0.3	0.02	30,000	25	0.004	0.2	0.01
		0.4	30,000	30	0.02	0.3	0.02	30,000	25	0.004	0.2	0.01
		0.5	30,000	30	0.014	0.4	0.014	30,000	25	0.004	0.3	0.006
		0.6	30,000	30	0.01	0.5	0.01	30,000	25	0.002	0.4	0.004
		0.8	30,000	30	0.004	0.7	0.004	30,000	25	0.002	0.6	0.002
2003	0.3	0.45	30,000	55	0.03	0.45	0.03	22,000	25	0.006	0.3	0.015
		0.6	30,000	55	0.03	0.45	0.03	22,000	25	0.006	0.3	0.015
		0.75	30,000	55	0.021	0.6	0.021	22,000	25	0.006	0.45	0.009
		0.9	30,000	55	0.015	0.75	0.015	22,000	25	0.003	0.6	0.006
		1.2	30,000	55	0.006	1.05	0.006	22,000	25	0.003	0.9	0.003
2004	0.4	0.6	27,000	60	0.04	0.6	0.04	17,000	25	0.008	0.4	0.02
		0.8	27,000	60	0.04	0.6	0.04	17,000	25	0.008	0.4	0.02
		1	27,000	60	0.028	0.8	0.028	17,000	25	0.008	0.6	0.012
		1.2	27,000	60	0.02	1	0.02	17,000	25	0.004	0.8	0.008
		1.6	27,000	60	0.008	1.4	0.008	17,000	25	0.004	1.2	0.004
2005	0.5	0.75	21,500	60	0.05	0.75	0.05	13,000	25	0.01	0.5	0.025
		0.8	21,500	60	0.05	0.75	0.05	13,000	25	0.01	0.5	0.025
		1	21,500	60	0.05	0.75	0.05	13,000	25	0.01	0.5	0.025
2006	0.6	1.25	21,500	60	0.035	1	0.035	13,000	25	0.01	0.75	0.015
		1.5	21,500	60	0.025	1.25	0.025	13,000	25	0.005	1	0.01
		2	21,500	60	0.01	1.75	0.01	13,000	25	0.005	1.5	0.005
		0.9	18,000	60	0.06	0.9	0.06	11,000	25	0.012	0.6	0.03
		1	18,000	60	0.06	0.9	0.06	11,000	25	0.012	0.6	0.03
2007	0.7	1.2	18,000	60	0.06	0.9	0.06	11,000	25	0.012	0.6	0.03
		1.5	18,000	60	0.042	1.2	0.042	11,000	25	0.012	0.9	0.018
		1.8	18,000	60	0.03	1.5	0.03	11,000	25	0.006	1.2	0.012
		2.4	18,000	60	0.012	2.1	0.012	11,000	25	0.006	1.8	0.006
		1	15,500	60	0.07	1.05	0.07	10,000	25	0.014	0.7	0.035
2008	0.8	1.4	15,500	60	0.07	1.05	0.07	10,000	25	0.014	0.7	0.035
		1.75	15,500	60	0.049	1.4	0.049	10,000	25	0.014	1.05	0.021
		2.1	15,500	60	0.035	1.75	0.035	10,000	25	0.007	1.4	0.014
		2.8	15,500	60	0.014	2.45	0.014	10,000	25	0.007	2.1	0.007
		1.2	13,800	60	0.08	1.2	0.08	8,800	30	0.016	0.8	0.04
2009	0.9	1.6	13,800	60	0.08	1.2	0.08	8,800	30	0.016	0.8	0.04
		2	13,800	60	0.056	1.6	0.056	8,800	30	0.016	1.2	0.024
		2.4	13,800	60	0.04	2	0.04	8,800	30	0.008	1.6	0.016
		3.2	13,800	60	0.016	2.8	0.016	8,800	30	0.008	2.4	0.008
		1.2	12,000	65	0.09	1.35	0.09	7,800	30	0.018	0.9	0.045
2010	1	1.8	12,000	65	0.09	1.35	0.09	7,800	30	0.018	0.9	0.045
		2.25	12,000	65	0.063	1.8	0.063	7,800	30	0.018	1.35	0.027
		2.7	12,000	65	0.045	2.25	0.045	7,800	30	0.009	1.8	0.018
		3.6	12,000	65	0.018	3.15	0.018	7,800	30	0.009	2.7	0.009
		1.5	11,000	65	0.25	1.5	0.1	7,100	30	0.05	1	0.05
2012	1.2	2	11,000	65	0.25	1.5	0.1	7,100	30	0.05	1	0.05
		2.5	11,000	65	0.2	2	0.07	7,100	30	0.03	1.5	0.03
		3	11,000	65	0.125	2.5	0.05	7,100	30	0.02	2	0.02
		4	11,000	65	0.075	3.5	0.02	7,100	30	0.01	3	0.01
		1.8	9,400	65	0.3	1.8	0.12	6,000	30	0.06	1.2	0.06
2015	1.5	2.4	9,400	65	0.3	1.8	0.12	6,000	30	0.06	1.2	0.06
		3	9,400	65	0.24	2.4	0.084	6,000	30	0.036	1.8	0.036
		3.6	9,400	65	0.15	3	0.06	6,000	30	0.024	2.4	0.024
		4	9,400	65	0.09	4	0.024	6,000	30	0.012	3.6	0.012
		4.8	9,400	65	0.09	4.2	0.024	6,000	30	0.012	3.6	0.012
2015	1.5	2.25	8,000	70	0.375	2.25	0.15	5,100	35	0.075	1.5	0.075
		3	8,000	70	0.375	2.25	0.15	5,100	35	0.075	1.5	0.075
		3.75	8,000	70	0.3	3	0.105	5,100	35	0.045	2.25	0.045
		4	8,000	70	0.1875	3.75	0.075	5,100	35	0.03	3	0.03
		4.5	8,000	70	0.1875	3.75	0.075	5,100	35	0.03	3	0.03
		6	8,000	70	0.1125	5.25	0.03	5,100	35	0.015	4.5	0.015

Ø3mm Shank
V SeriesUDC-PCD
SeriesCBN
Series

Square

Long Neck
Square

Radius

Long Neck
RadiusTaper Neck
RadiusBall / Long
Shank BallLong Neck
BallTaper Neck
Ball

Taper

Barrel

Spiral
V Cutter

Drill

Technical Data

Milling Conditions for C-CES (2 Flutes)

WORK MATERIAL			CARBON STEELS S45C / S50C (~225HB)					ALLOY STEELS SK / SCM / SUS (225~325HB)				
Model Number	Outside Diameter (mm)	Length of Cut (mm)	Spindle Speed (min ⁻¹)	Feed Rate (mm/min)	Slotting	Side Milling		Spindle Speed (min ⁻¹)	Feed Rate (mm/min)	Slotting	Side Milling	
					a _p (mm)	a _p (mm)	a _e (mm)			a _p (mm)	a _e (mm)	
2018	1.8	2.7	11,500	130	0.45	2.7	0.18	8,800	120	0.45	2.7	0.18
		3.6	11,500	130	0.45	2.7	0.18	8,800	120	0.45	2.7	0.18
		4.5	11,500	130	0.36	3.6	0.126	8,800	120	0.36	3.6	0.126
		5	11,500	130	0.225	4.5	0.09	8,800	120	0.225	4.5	0.09
		5.4	11,500	130	0.225	4.5	0.09	8,800	120	0.225	4.5	0.09
2020	2	7.2	11,500	130	0.135	6.3	0.036	8,800	120	0.135	6.3	0.036
		3	11,000	130	0.5	3	0.2	8,500	120	0.5	3	0.2
		4	11,000	130	0.5	3	0.2	8,500	120	0.5	3	0.2
		5	11,000	130	0.4	4	0.14	8,500	120	0.4	4	0.14
		6	11,000	130	0.25	5	0.1	8,500	120	0.25	5	0.1
2025	2.5	8	11,000	130	0.15	7	0.04	8,500	120	0.15	7	0.04
		3.75	8,800	195	0.625	3.75	0.25	7,000	135	0.625	3.75	0.25
		5	8,800	195	0.625	3.75	0.25	7,000	135	0.625	3.75	0.25
		6.25	8,800	195	0.5	5	0.175	7,000	135	0.5	5	0.175
		7.5	8,800	195	0.3125	6.25	0.125	7,000	135	0.3125	6.25	0.125
2030	3	8	8,800	195	0.1875	8	0.05	7,000	135	0.1875	8	0.05
		10	8,800	195	0.1875	8.75	0.05	7,000	135	0.1875	8.75	0.05
		4.5	7,400	195	1.5	4.5	0.3	6,400	145	1.5	4.5	0.3
		6	7,400	195	1.5	4.5	0.3	6,400	145	1.5	4.5	0.3
		7.5	7,400	195	1.2	6	0.21	6,400	145	1.2	6	0.21
2040	4	8	7,400	195	0.9	7.5	0.15	6,400	145	0.9	7.5	0.15
		9	7,400	195	0.9	7.5	0.15	6,400	145	0.9	7.5	0.15
		12	7,400	195	0.45	10.5	0.06	6,400	145	0.45	10.5	0.06
		6	5,900	230	2	6	0.4	5,000	190	2	6	0.4
		8	5,900	230	2	6	0.4	5,000	190	2	6	0.4
2050	5	10	5,900	230	1.6	8	0.28	5,000	190	1.6	8	0.28
		11	5,900	230	1.2	10	0.2	5,000	190	1.2	10	0.2
		12	5,900	230	1.2	10	0.2	5,000	190	1.2	10	0.2
		16	5,900	230	0.6	14	0.08	5,000	190	0.6	14	0.08
		7.5	5,300	310	2.5	7.5	0.5	4,200	230	2.5	7.5	0.5
2060	6	10	5,300	310	2.5	7.5	0.5	4,200	230	2.5	7.5	0.5
		12.5	5,300	310	2	10	0.35	4,200	230	2	10	0.35
		13	5,300	310	1.5	12.5	0.25	4,200	230	1.5	12.5	0.25
		15	5,300	310	1.5	12.5	0.25	4,200	230	1.5	12.5	0.25
		20	5,300	310	0.75	17.5	0.1	4,200	230	0.75	17.5	0.1
2080	8	9	4,400	305	3	9	0.6	3,500	230	3	9	0.6
		12	4,400	305	3	9	0.6	3,500	230	3	9	0.6
		13	4,400	305	2.4	12	0.42	3,500	230	2.4	12	0.42
		15	4,400	305	2.4	15	0.42	3,500	230	2.4	12	0.42
		18	4,400	305	1.8	15	0.3	3,500	230	1.8	15	0.3
2100	10	24	4,400	305	0.9	21	0.12	3,500	230	0.9	21	0.12
		16	3,300	290	4	12	0.8	2,600	230	4	12	0.8
		19	3,300	290	3.2	16	0.56	2,600	230	3.2	16	0.56
		20	3,300	290	3.2	16	0.56	2,600	230	3.2	16	0.56
		24	3,300	290	2.4	20	0.4	2,600	230	2.4	20	0.4
2120	12	32	3,300	290	1.2	28	0.16	2,600	230	1.2	28	0.16
		20	2,600	275	5	15	1	2,100	225	5	15	1
		22	2,600	275	4	20	0.7	2,100	225	4	20	0.7
		25	2,600	275	4	20	0.7	2,100	225	4	20	0.7
		30	2,600	275	3	25	0.5	2,100	225	3	25	0.5
2120	12	40	2,600	275	1.5	35	0.2	2,100	225	1.5	35	0.2
		24	2,200	275	6	18	1.2	1,750	225	6	18	1.2
		26	2,200	275	4.8	24	0.84	1,750	225	4.8	24	0.84
		30	2,200	275	4.8	24	0.84	1,750	225	4.8	24	0.84
		36	2,200	275	3.6	30	0.6	1,750	225	3.6	30	0.6
48	2,200	275	1.8	42	0.24	1,750	225	1.8	42	0.24		

φ3mm Shank V Series

UDC-PCD Series

CBN Series

Square

Long Neck Square

Radius

Long Neck Radius

Taper Neck Radius

Ball / Long Shank Ball

Long Neck Ball

Taper Neck Ball

Taper

Barrel

Spiral V Cutter

Drill

Technical Data

Milling Conditions for C-CES (2 Flutes)

WORK MATERIAL			PREHARDENED STEELS / HARDENED STEELS NAK / SKD (30~45HRC)					HARDENED STEELS SKD / SKT (45~55HRC)				
Model Number	Outside Diameter (mm)	Length of Cut (mm)	Spindle Speed (min ⁻¹)	Feed Rate (mm/min)	Side Milling			Spindle Speed (min ⁻¹)	Feed Rate (mm/min)	Side Milling		
					a _p (mm)	a _p (mm)	a _e (mm)			a _p (mm)	a _p (mm)	a _e (mm)
2018	1.8	2.7	7,000	70	0.45	2.7	0.18	4,400	35	0.09	1.8	0.09
		3.6	7,000	70	0.45	2.7	0.18	4,400	35	0.09	1.8	0.09
		4.5	7,000	70	0.36	3.6	0.126	4,400	35	0.054	2.7	0.054
		5	7,000	70	0.225	4.5	0.09	4,400	35	0.036	3.6	0.036
		5.4	7,000	70	0.225	4.5	0.09	4,400	35	0.036	3.6	0.036
2020	2	7.2	7,000	70	0.135	6.3	0.036	4,400	35	0.018	5.4	0.018
		3	6,400	70	0.5	3	0.2	4,000	40	0.1	2	0.1
		4	6,400	70	0.5	3	0.2	4,000	40	0.1	2	0.1
		5	6,400	70	0.4	4	0.14	4,000	40	0.06	3	0.06
		6	6,400	70	0.25	5	0.1	4,000	40	0.04	4	0.04
2025	2.5	8	6,400	70	0.15	7	0.04	4,000	40	0.02	6	0.02
		3.75	5,000	70	0.625	3.75	0.25	3,200	40	0.125	2.5	0.125
		5	5,000	70	0.625	3.75	0.25	3,200	40	0.125	2.5	0.125
		6.25	5,000	70	0.5	5	0.175	3,200	40	0.075	3.75	0.075
		7.5	5,000	70	0.3125	6.25	0.125	3,200	40	0.05	5	0.05
2030	3	8	5,000	70	0.1875	8	0.05	3,200	40	0.025	7.5	0.025
		10	5,000	70	0.1875	8.75	0.05	3,200	40	0.025	7.5	0.025
		4.5	4,500	80	1.5	4.5	0.3	2,800	45	0.15	3	0.15
		6	4,500	80	1.5	4.5	0.3	2,800	45	0.15	3	0.15
		7.5	4,500	80	1.2	6	0.21	2,800	45	0.09	4.5	0.09
2040	4	8	4,500	80	0.9	7.5	0.15	2,800	45	0.06	6	0.06
		9	4,500	80	0.9	7.5	0.15	2,800	45	0.06	6	0.06
		12	4,500	80	0.45	10.5	0.06	2,800	45	0.03	9	0.03
		6	3,500	90	2	6	0.4	2,150	50	0.2	4	0.2
		8	3,500	90	2	6	0.4	2,150	50	0.2	4	0.2
2050	5	10	3,500	90	1.6	8	0.28	2,150	50	0.12	6	0.12
		11	3,500	90	1.2	10	0.2	2,150	50	0.08	8	0.08
		12	3,500	90	1.2	10	0.2	2,150	50	0.08	8	0.08
		16	3,500	90	0.6	14	0.08	2,150	50	0.04	12	0.04
		7.5	2,950	90	2.5	7.5	0.5	1,850	55	0.25	5	0.25
2060	6	10	2,950	90	2.5	7.5	0.5	1,850	55	0.25	5	0.25
		12.5	2,950	90	2	10	0.35	1,850	55	0.15	7.5	0.15
		13	2,950	90	1.5	12.5	0.25	1,850	55	0.1	10	0.1
		15	2,950	90	1.5	12.5	0.25	1,850	55	0.1	10	0.1
		20	2,950	90	0.75	17.5	0.1	1,850	55	0.05	15	0.05
2080	8	9	2,450	100	3	9	0.6	1,500	55	0.3	6	0.3
		12	2,450	100	3	9	0.6	1,500	55	0.3	6	0.3
		13	2,450	100	2.4	12	0.42	1,500	55	0.18	9	0.18
		15	2,450	100	2.4	12	0.42	1,500	55	0.18	9	0.18
		18	2,450	100	1.8	15	0.3	1,500	55	0.12	12	0.12
2100	10	24	2,450	100	0.9	21	0.12	1,500	55	0.06	18	0.06
		16	1,850	95	4	12	0.8	1,200	50	0.4	8	0.4
		19	1,850	95	3.2	16	0.56	1,200	50	0.24	12	0.24
		20	1,850	95	3.2	16	0.56	1,200	50	0.24	12	0.24
		24	1,850	95	2.4	20	0.4	1,200	50	0.16	16	0.16
2120	12	32	1,850	95	1.2	28	0.16	1,200	50	0.08	24	0.08
		20	1,450	95	5	15	1	950	50	0.5	10	0.5
		22	1,450	95	4	20	0.7	950	50	0.3	15	0.3
		25	1,450	95	4	20	0.7	950	50	0.3	15	0.3
		30	1,450	95	3	25	0.5	950	50	0.2	20	0.2
2120	12	40	1,450	95	1.5	35	0.2	950	50	0.1	30	0.1
		24	1,200	90	6	18	1.2	800	45	0.6	12	0.6
		26	1,200	90	4.8	24	0.84	800	45	0.36	18	0.36
		30	1,200	90	4.8	24	0.84	800	45	0.36	18	0.36
		36	1,200	90	3.6	30	0.6	800	45	0.24	24	0.24
2120	12	48	1,200	90	1.8	42	0.24	800	45	0.12	36	0.12

Ø3mm Shank
V SeriesUDC-PCD
SeriesCBN
Series

Square

Square
Long Neck
Square

Radius

Radius
Long Neck
RadiusTaper Neck
RadiusBall / Long
Shank BallBall
Long Neck
BallTaper Neck
Ball

Taper

Barrel

Spiral
V Cutter

Drill

Technical Data

Milling Conditions for C-CES (2 Flutes)

◆High speed milling

WORK MATERIAL			CARBON STEELS S45C / S50C (~225HB)					ALLOY STEELS SK / SCM / SUS (225~325HB)						
Model Number	Outside Diameter (mm)	Length of Cut (mm)	Spindle Speed (min ⁻¹)	Feed Rate (mm/min)	Slotting		Side Milling		Spindle Speed (min ⁻¹)	Feed Rate (mm/min)	Slotting		Side Milling	
					a _p (mm)	a _e (mm)	a _p (mm)	a _e (mm)			a _p (mm)	a _e (mm)		
2030	3	4.5	30,000	790	1.5	4.5	0.3	26,500	600	1.5	4.5	0.3		
		6	30,000	790	1.5	4.5	0.3	26,500	600	1.5	4.5	0.3		
		7.5	30,000	790	1.2	6	0.21	26,500	600	1.2	6	0.21		
		8	30,000	790	0.9	7.5	0.15	26,500	600	0.9	7.5	0.15		
		12	30,000	790	0.45	10.5	0.06	26,500	600	0.45	10.5	0.06		
2040	4	6	23,800	930	2	6	0.4	19,800	750	2	6	0.4		
		8	23,800	930	2	6	0.4	19,800	750	2	6	0.4		
		10	23,800	930	1.6	8	0.28	19,800	750	1.6	8	0.28		
		11	23,800	930	1.2	10	0.2	19,800	750	1.2	10	0.2		
		12	23,800	930	1.2	10	0.2	19,800	750	1.2	10	0.2		
2050	5	16	23,800	930	0.6	14	0.08	19,800	750	0.6	14	0.08		
		7.5	19,000	1,110	2.5	7.5	0.5	15,800	865	2.5	7.5	0.5		
		10	19,000	1,110	2.5	7.5	0.5	15,800	865	2.5	7.5	0.5		
		12.5	19,000	1,110	2	10	0.35	15,800	865	2	10	0.35		
		13	19,000	1,110	1.5	12.5	0.25	15,800	865	1.5	12.5	0.25		
2060	6	15	19,000	1,110	1.5	12.5	0.25	15,800	865	1.5	12.5	0.25		
		20	19,000	1,110	0.75	17.5	0.1	15,800	865	0.75	17.5	0.1		
		9	15,900	1,110	3	9	0.6	13,200	865	3	9	0.6		
		12	15,900	1,110	3	9	0.6	13,200	865	3	9	0.6		
		13	15,900	1,110	2.4	12	0.42	13,200	865	2.4	12	0.42		
2080	8	15	15,900	1,110	2.4	12	0.42	13,200	865	2.4	12	0.42		
		18	15,900	1,110	1.8	15	0.3	13,200	865	1.8	15	0.3		
		24	15,900	1,110	0.9	21	0.12	13,200	865	0.9	21	0.12		
		16	11,900	1,045	4	12	0.8	9,900	875	4	12	0.8		
		19	11,900	1,045	3.2	16	0.56	9,900	875	3.2	16	0.56		
2100	10	20	11,900	1,045	3.2	16	0.56	9,900	875	3.2	16	0.56		
		24	11,900	1,045	2.4	20	0.4	9,900	875	2.4	20	0.4		
		32	11,900	1,045	1.2	28	0.16	9,900	875	1.2	28	0.16		
		20	9,500	1,005	5	15	1	7,900	845	5	15	1		
		22	9,500	1,005	4	20	0.7	7,900	845	4	20	0.7		
2120	12	25	9,500	1,005	4	20	0.7	7,900	845	4	20	0.7		
		30	9,500	1,005	3	25	0.5	7,900	845	3	25	0.5		
		24	7,900	1,000	6	18	1.2	6,600	850	6	18	1.2		
		26	7,900	1,000	4.8	24	0.84	6,600	850	4.8	24	0.84		
		30	7,900	1,000	4.8	24	0.84	6,600	850	4.8	24	0.84		
2120	12	36	7,900	1,000	3.6	30	0.6	6,600	850	3.6	30	0.6		
		48	7,900	1,000	1.8	42	0.24	6,600	850	1.8	42	0.24		

φ3mm Shank V Series

UDC-PCD Series

CBN Series

Square
Long Neck Square

Radius

Radius
Long Neck Radius
Taper Neck Radius

Ball / Long Shank Ball

Ball
Long Neck Ball
Taper Neck Ball

Taper

Barrel

Spiral V Cutter

Drill

Technical Data

Milling Conditions for C-CES (2 Flutes)

WORK MATERIAL			PREHARDENED STEELS / HARDENED STEELS NAK / SKD (30~45HRC)					HARDENED STEELS SKD / SKT (45~55HRC)						
Model Number	Outside Diameter (mm)	Length of Cut (mm)	Spindle Speed (min ⁻¹)	Feed Rate (mm/min)	Slotting		Side Milling		Spindle Speed (min ⁻¹)	Feed Rate (mm/min)	Slotting		Side Milling	
					a _p (mm)	a _e (mm)	a _p (mm)	a _e (mm)			a _p (mm)	a _e (mm)	a _p (mm)	a _e (mm)
2030	3	4.5	21,200	375	1.5	4.5	0.3	15,800	255	0.15	3	0.15		
		6	21,200	375	1.5	4.5	0.3	15,800	255	0.15	3	0.15		
		7.5	21,200	375	1.2	6	0.21	15,800	255	0.09	4.5	0.09		
		8	21,200	375	0.9	7.5	0.15	15,800	255	0.06	6	0.06		
		9	21,200	375	0.9	7.5	0.15	15,800	255	0.06	6	0.06		
		12	21,200	375	0.45	10.5	0.06	15,800	255	0.03	9	0.03		
2040	4	6	15,800	405	2	6	0.4	11,900	275	0.2	4	0.2		
		8	15,800	405	2	6	0.4	11,900	275	0.2	4	0.2		
		10	15,800	405	1.6	8	0.28	11,900	275	0.12	6	0.12		
		11	15,800	405	1.2	10	0.2	11,900	275	0.08	8	0.08		
		12	15,800	405	1.2	10	0.2	11,900	275	0.08	8	0.08		
		16	15,800	405	0.6	14	0.08	11,900	275	0.04	12	0.04		
2050	5	7.5	12,700	385	2.5	7.5	0.5	9,500	280	0.25	5	0.25		
		10	12,700	385	2.5	7.5	0.5	9,500	280	0.25	5	0.25		
		12.5	12,700	385	2	10	0.35	9,500	280	0.15	7.5	0.15		
		13	12,700	385	1.5	12.5	0.25	9,500	280	0.1	10	0.1		
		15	12,700	385	1.5	12.5	0.25	9,500	280	0.1	10	0.1		
		20	12,700	385	0.75	17.5	0.1	9,500	280	0.05	15	0.05		
2060	6	9	10,600	435	3	9	0.6	7,900	290	0.3	6	0.3		
		12	10,600	435	3	9	0.6	7,900	290	0.3	6	0.3		
		13	10,600	435	2.4	12	0.42	7,900	290	0.18	9	0.18		
		15	10,600	435	2.4	12	0.42	7,900	290	0.18	9	0.18		
		18	10,600	435	1.8	15	0.3	7,900	290	0.12	12	0.12		
		24	10,600	435	0.9	21	0.12	7,900	290	0.06	18	0.06		
2080	8	16	7,900	405	4	12	0.8	5,900	245	0.4	8	0.4		
		19	7,900	405	3.2	16	0.56	5,900	245	0.24	12	0.24		
		20	7,900	405	3.2	16	0.56	5,900	245	0.24	12	0.24		
		24	7,900	405	2.4	20	0.4	5,900	245	0.16	16	0.16		
		32	7,900	405	1.2	28	0.16	5,900	245	0.08	24	0.08		
2100	10	20	6,300	415	5	15	1	4,700	245	0.5	10	0.5		
		22	6,300	415	4	20	0.7	4,700	245	0.3	15	0.3		
		25	6,300	415	4	20	0.7	4,700	245	0.3	15	0.3		
		30	6,300	415	3	25	0.5	4,700	245	0.2	20	0.2		
2120	12	24	5,300	400	6	18	1.2	3,900	219	0.6	12	0.6		
		26	5,300	400	4.8	24	0.84	3,900	219	0.36	18	0.36		
		30	5,300	400	4.8	24	0.84	3,900	219	0.36	18	0.36		
		36	5,300	400	3.6	30	0.6	3,900	219	0.24	24	0.24		
		48	5,300	400	1.8	42	0.24	3,900	219	0.12	36	0.12		

Ø3mm Shank
V SeriesUDC-PCD
SeriesCBN
Series

Square

Long Neck
Square

Radius

Long Neck
RadiusTaper Neck
RadiusBall / Long
Shank BallLong Neck
BallTaper Neck
Ball

Taper

Barrel

Spiral
V Cutter

Drill

Technical Data

Milling Conditions for C-CES (2 Flutes)

Milling amount for slotting (mm)
 $D < \phi 1$

Length of Cut \ Work Material	2D or below	2.5D or below	3D or below	4D or below
	45HRC or below	$a_p=0.1D$	$a_p=0.07D$	$a_p=0.05D$
45HRC or above	$a_p=0.02D$	$a_p=0.02D$	$a_p=0.01D$	$a_p=0.01D$

$\phi 1 \leq D < \phi 3$

Length of Cut \ Work Material	2D or below	2.5D or below	3D or below	4D or below
	45HRC or below	$a_p=0.25D$	$a_p=0.2D$	$a_p=0.125D$
45HRC or above	$a_p=0.05D$	$a_p=0.03D$	$a_p=0.02D$	$a_p=0.01D$

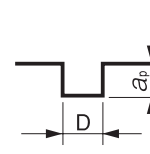

$\phi 3 \leq D$

Length of Cut \ Work Material	2D or below	2.5D or below	3D or below	4D or below
	45HRC or below	$a_p=0.5D$	$a_p=0.4D$	$a_p=0.3D$
45HRC or above	$a_p=0.05D$	$a_p=0.03D$	$a_p=0.02D$	$a_p=0.01D$

Milling amount for side milling (mm)

Length of Cut \ Work Material	2D or below	2.5D or below	3D or below	4D or below
	45HRC or below	$a_p=1.5D$ $a_e=0.1D$	$a_p=2D$ $a_e=0.07D$	$a_p=2.5D$ $a_e=0.05D$
45HRC or above	$a_p=1D$ $a_e=0.05D$	$a_p=1.5D$ $a_e=0.03D$	$a_p=2D$ $a_e=0.02D$	$a_p=3D$ $a_e=0.01D$

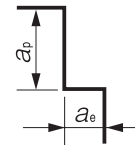

D : Outside Diameter (mm)

Ex.) 2D or below : Flute Length = Diameter × 2 or below

Note:

- Recommend water soluble or oil coolant.
- Recommend oil coolant for Titanium Alloys and Heat Resistant Alloys.

∅3mm Shank
V Series

UDC-PCD
Series

CBN
Series

Square

Square

Long Neck
Square

Radius

Radius

Long Neck
Radius

Taper Neck
Radius

Ball

Ball / Long
Shank Ball

Long Neck
Ball

Taper Neck
Ball

Taper

Taper

Barrel

Spiral
V Cutter

Drill

Technical Data



Size $\phi 0.2 \sim \phi 12$

C-CES2000S



Material Applications (★ Highly Recommended ● Recommended ○ Suggested)

Work Material																	
Carbon Steels S45C S55C	Alloy Steels SK / SCM SUS	Prehardened Steels NAK HPM	Hardened Steels					Cast Iron	Aluminum Alloys	Graphite	Copper	Plastics	Glass Filled Plastics	Titanium Alloys	Heat Resistant Alloys	Cemented Carbide	Hard Brittle (Non-Metallic) Materials
			~50HRC	~55HRC	~60HRC	~65HRC	~70HRC										
●	●	●	●	○				○			●			○	○		

Features

2 flute C-CES with a sharp corner design.

Broad application range from Copper and Carbon Steels up to Hardened Steels (55HRC).

Excellent performance/quality to price ratio.

Refer to page 200 for 4 flute C-CES-S.

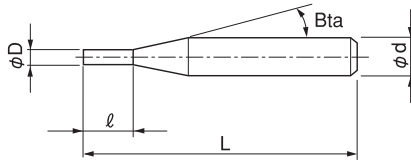

The shank taper angle shown is not an exact value and to avoid contact with the work piece, we recommend the user controls the precise value of this angle. Shank taper angle should not make contact with the work piece.

Total 35 models

Unit (mm)

Model Number	Outside Diameter ϕD	Length of Cut ℓ	Shank Taper Angle Bta	Overall Length L	Shank Diameter ϕd	Suggested Retail Price \yen
C-CES 2002-0030S	0.2	0.3	16°	45	4	4,680
C-CES 2002-0060S		0.6		45		
C-CES 2003-0045S	0.3	0.45	16°	45	4	4,080
C-CES 2003-0090S		0.9		45		
C-CES 2004-0060S	0.4	0.6	16°	45	4	4,560
C-CES 2004-0120S		1.2		45		
C-CES 2005-0075S	0.5	0.75	16°	45	4	2,280
C-CES 2005-0150S		1.5		45		
C-CES 2006-0090S	0.6	0.9	16°	45	4	3,480
C-CES 2007-0105S	0.7	1.05	16°	45	4	3,840
C-CES 2008-0120S	0.8	1.2	16°	45	4	2,280
C-CES 2008-0240S		2.4		45		
C-CES 2009-0135S	0.9	1.35	16°	45	4	3,840
C-CES 2010-0150S	1	1.5	16°	45	4	2,040
C-CES 2010-0300S		3		45		
C-CES 2012-0180S	1.2	1.8	16°	45	4	2,280
C-CES 2012-0360S		3.6		45		

Next Page ➡

Unit (mm)

Model Number	Outside Diameter ϕD	Length of Cut ℓ	Shank Taper Angle Bta	Overall Length L	Shank Diameter ϕd	Suggested Retail Price ¥
C-CES 2015-0225S	1.5	2.25	16°	45	4	2,040
C-CES 2015-0450S		4.5		45		
C-CES 2018-0270S	1.8	2.7	16°	45	4	2,280
C-CES 2018-0540S		5.4		45		
C-CES 2020-0300S	2	3	16°	45	4	2,040
C-CES 2020-0600S		6		45		
C-CES 2025-0375S	2.5	3.75	16°	45	4	2,040
C-CES 2030-0450S	3	4.5	16°	45	6	2,640
C-CES 2030-0900S		9		45		
C-CES 2040-0600S	4	6	16°	50	6	2,880
C-CES 2040-1200S		12		50		
C-CES 2050-0750S	5	7.5	16°	50	6	3,120
C-CES 2050-1500S		15		50		
C-CES 2060-0900S	6	9	—	50	6	3,360
C-CES 2060-1800S		18		50		
C-CES 2080-2400S	8	24	—	80	8	6,320
C-CES 2100-3000S	10	30	—	80	10	7,580
C-CES 2120-3600S	12	36	—	90	12	11,170

$\phi 3$ mm Shank
V Series

UDC-PCD
Series

CBN
Series

Square

Square

Long Neck
Square

Radius

Radius

Long Neck
Radius

Taper Neck
Radius

Ball

Ball / Long
Shank Ball

Long Neck
Ball

Taper Neck
Ball

Taper

Taper

Barrel

Barrel

Spiral

Spiral
V Cutter

Drill

Drill

Technical Data

Technical Data

Milling Conditions for C-CES-S (2 Flutes)

WORK MATERIAL			CARBON STEELS S45C / S50C (~225HB)					ALLOY STEELS SK / SCM / SUS (225~325HB)				
Model Number	Outside Diameter (mm)	Length of Cut (mm)	Spindle Speed (min ⁻¹)	Feed Rate (mm/min)	Slotting	Side Milling		Spindle Speed (min ⁻¹)	Feed Rate (mm/min)	Slotting	Side Milling	
					a _p (mm)	a _p (mm)	a _e (mm)			a _p (mm)	a _p (mm)	a _e (mm)
2002	0.2	0.3	27,000	60	0.02	0.3	0.02	27,000	60	0.02	0.3	0.02
		0.6	27,000	60	0.01	0.5	0.01	27,000	60	0.01	0.5	0.01
2003	0.3	0.45	27,000	77	0.03	0.45	0.03	27,000	77	0.03	0.45	0.03
		0.9	27,000	77	0.015	0.75	0.015	27,000	77	0.015	0.75	0.015
2004	0.4	0.6	27,000	84	0.04	0.6	0.04	27,000	84	0.04	0.6	0.04
		1.2	27,000	84	0.02	1	0.02	27,000	84	0.02	1	0.02
2005	0.5	0.75	27,000	84	0.05	0.75	0.05	26,100	84	0.05	0.75	0.05
		1.5	27,000	84	0.025	1.25	0.025	26,100	84	0.025	1.25	0.025
2006	0.6	0.9	27,000	84	0.06	0.9	0.06	21,600	84	0.06	0.9	0.06
2007	0.7	1.05	24,750	84	0.07	1.05	0.07	18,900	84	0.07	1.05	0.07
2008	0.8	1.2	21,600	84	0.08	1.2	0.08	17,100	84	0.08	1.2	0.08
		2.4	21,600	84	0.04	2	0.04	17,100	84	0.04	2	0.04
2009	0.9	1.35	19,350	88	0.09	1.35	0.09	14,850	84	0.09	1.35	0.09
2010	1	1.5	18,000	88	0.25	1.5	0.1	13,500	84	0.25	1.5	0.1
		3	18,000	88	0.125	2.5	0.05	13,500	84	0.125	2.5	0.05
2012	1.2	1.8	15,030	91	0.3	1.8	0.12	11,250	84	0.3	1.8	0.12
		3.6	15,030	91	0.15	3	0.06	11,250	84	0.15	3	0.06
2015	1.5	2.25	12,150	91	0.375	2.25	0.15	9,000	84	0.375	2.25	0.15
		4.5	12,150	91	0.1875	3.75	0.075	9,000	84	0.1875	3.75	0.075
2018	1.8	2.7	10,350	91	0.45	2.7	0.18	7,920	84	0.45	2.7	0.18
		5.4	10,350	91	0.225	4.5	0.09	7,920	84	0.225	4.5	0.09
2020	2	3	9,900	91	0.5	3	0.2	7,650	84	0.5	3	0.2
		6	9,900	91	0.25	5	0.1	7,650	84	0.25	5	0.1
2025	2.5	3.75	7,920	137	0.625	3.75	0.25	6,300	95	0.625	3.75	0.25
2030	3	4.5	6,660	137	1.5	4.5	0.3	5,760	102	1.5	4.5	0.3
		9	6,660	137	0.9	7.5	0.15	5,760	102	0.9	7.5	0.15
2040	4	6	5,310	161	2	6	0.4	4,500	133	2	6	0.4
		12	5,310	161	1.2	10	0.2	4,500	133	1.2	10	0.2
2050	5	7.5	4,770	217	2.5	7.5	0.5	3,780	161	2.5	7.5	0.5
		15	4,770	217	1.5	12.5	0.25	3,780	161	1.5	12.5	0.25
2060	6	9	3,960	214	3	9	0.6	3,150	161	3	9	0.6
		18	3,960	214	1.8	15	0.3	3,150	161	1.8	15	0.3
2080	8	24	2,970	203	2.4	20	0.4	2,340	161	2.4	20	0.4
2100	10	30	2,340	193	3	25	0.5	1,890	158	3	25	0.5
2120	12	36	1,980	193	3.6	30	0.6	1,575	158	3.6	30	0.6

- φ3mm Shank V Series
- UDC-PCD Series
- CBN Series
- Square
- Long Neck Square
- Radius
- Long Neck Radius
- Taper Neck Radius
- Ball / Long Shank Ball
- Long Neck Ball
- Taper Neck Ball
- Taper
- Barrel
- Spiral V Cutter
- Drill
- Technical Data

Milling Conditions for C-CES-S (2 Flutes)

WORK MATERIAL			PREHARDENED STEELS HARDENED STEELS NAK / SKD (30~45HRC)					HARDENED STEELS SKD / SKT (45~55HRC)				
Model Number	Outside Diameter (mm)	Length of Cut (mm)	Spindle Speed (min ⁻¹)	Feed Rate (mm/min)	Slotting	Side Milling		Spindle Speed (min ⁻¹)	Feed Rate (mm/min)	Slotting	Side Milling	
					a _p (mm)	a _p (mm)	a _e (mm)			a _p (mm)	a _p (mm)	a _e (mm)
2002	0.2	0.3	24,000	21	0.02	0.3	0.02	24,000	18	0.004	0.2	0.01
		0.6	24,000	21	0.01	0.5	0.01	24,000	18	0.002	0.4	0.004
2003	0.3	0.45	24,000	39	0.03	0.45	0.03	17,600	18	0.006	0.3	0.015
		0.9	24,000	39	0.015	0.75	0.015	17,600	18	0.003	0.6	0.006
2004	0.4	0.6	21,600	42	0.04	0.6	0.04	13,600	18	0.008	0.4	0.02
		1.2	21,600	42	0.02	1	0.02	13,600	18	0.004	0.8	0.008
2005	0.5	0.75	17,200	42	0.05	0.75	0.05	10,400	18	0.01	0.5	0.025
		1.5	17,200	42	0.025	1.25	0.025	10,400	18	0.005	1	0.01
2006	0.6	0.9	14,400	42	0.06	0.9	0.06	8,800	18	0.012	0.6	0.03
2007	0.7	1.05	12,400	42	0.07	1.05	0.07	8,000	18	0.014	0.7	0.035
2008	0.8	1.2	11,040	42	0.08	1.2	0.08	7,040	21	0.016	0.8	0.04
		2.4	11,040	42	0.04	2	0.04	7,040	21	0.008	1.6	0.016
2009	0.9	1.35	9,600	46	0.09	1.35	0.09	6,240	21	0.018	0.9	0.045
2010	1	1.5	8,800	46	0.25	1.5	0.1	5,680	21	0.05	1	0.05
		3	8,800	46	0.125	2.5	0.05	5,680	21	0.02	2	0.02
2012	1.2	1.8	7,520	46	0.3	1.8	0.12	4,800	21	0.06	1.2	0.06
		3.6	7,520	46	0.15	3	0.06	4,800	21	0.024	2.4	0.024
2015	1.5	2.25	6,400	49	0.375	2.25	0.15	4,080	25	0.075	1.5	0.075
		4.5	6,400	49	0.1875	3.75	0.075	4,080	25	0.03	3	0.03
2018	1.8	2.7	5,600	49	0.45	2.7	0.18	3,520	25	0.09	1.8	0.09
		5.4	5,600	49	0.225	4.5	0.09	3,520	25	0.036	3.6	0.036
2020	2	3	5,120	49	0.5	3	0.2	3,200	28	0.1	2	0.1
		6	5,120	49	0.25	5	0.1	3,200	28	0.04	4	0.04
2025	2.5	3.75	4,000	49	0.625	3.75	0.25	2,560	28	0.125	2.5	0.125
2030	3	4.5	3,600	56	1.5	4.5	0.3	2,240	32	0.15	3	0.15
		9	3,600	56	0.9	7.5	0.15	2,240	32	0.06	6	0.06
2040	4	6	2,800	63	2	6	0.4	1,720	35	0.2	4	0.2
		12	2,800	63	1.2	10	0.2	1,720	35	0.08	8	0.08
2050	5	7.5	2,360	63	2.5	7.5	0.5	1,480	39	0.25	5	0.25
		15	2,360	63	1.5	12.5	0.25	1,480	39	0.1	10	0.1
2060	6	9	1,960	70	3	9	0.6	1,200	39	0.3	6	0.3
		18	1,960	70	1.8	15	0.3	1,200	39	0.12	12	0.12
2080	8	24	1,480	67	2.4	20	0.4	960	35	0.16	16	0.16
2100	10	30	1,160	67	3	25	0.5	760	35	0.2	20	0.2
2120	12	36	960	63	3.6	30	0.6	640	32	0.24	24	0.24

Ø3mm Shank
V SeriesUDC-PCD
SeriesCBN
Series

Square

Long Neck
Square

Radius

Long Neck
RadiusTaper Neck
RadiusBall / Long
Shank BallLong Neck
BallTaper Neck
Ball

Taper

Barrel

Spiral
V Cutter

Drill

Technical Data

Milling Conditions for C-CES-S (2 Flutes)

Milling amount for slotting (mm)
 $D < \phi 1$

Length of Cut	2D or below	3D or below
Work Material		
45HRC or below	$a_p = 0.1D$	$a_p = 0.05D$
45HRC or above	$a_p = 0.02D$	$a_p = 0.01D$

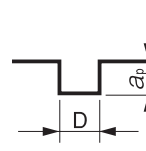

$\phi 1 \leq D < \phi 3$

Length of Cut	2D or below	3D or below
Work Material		
45HRC or below	$a_p = 0.25D$	$a_p = 0.125D$
45HRC or above	$a_p = 0.05D$	$a_p = 0.02D$

$\phi 3 \leq D$

Length of Cut	2D or below	3D or below
Work Material		
45HRC or below	$a_p = 0.5D$	$a_p = 0.3D$
45HRC or above	$a_p = 0.05D$	$a_p = 0.02D$

Milling amount for side milling (mm)

Length of Cut	2D or below	3D or below
Work Material		
45HRC or below	$a_p = 1.5D$ $a_e = 0.1D$	$a_p = 2.5D$ $a_e = 0.05D$
45HRC or above	$a_p = 1D$ $a_e = 0.05D$	$a_p = 2D$ $a_e = 0.02D$

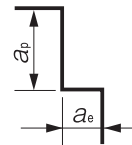

D : Outside Diameter (mm)

Ex.) 2D or below : Flute Length = Diameter \times 2 or below

Note:

- Recommend water soluble or oil coolant.
- Recommend oil coolant for Titanium Alloys and Heat Resistant Alloys.

$\phi 3$ mm Shank
V Series

UDC-PCD
Series

CBN
Series

Square

Long Neck
Square

Radius

Long Neck
Radius

Taper Neck
Radius

Ball / Long
Shank Ball

Long Neck
Ball

Taper Neck
Ball

Taper

Barrel

Spiral
V Cutter

Drill

Technical Data

∅3mm Shank
V Series

UDC-PCD
Series

CBN
Series

Square

Square

Long Neck
Square

Radius

Radius

Long Neck
Radius

Taper Neck
Radius

Ball

Ball / Long
Shank Ball

Long Neck
Ball

Taper Neck
Ball

Taper

Taper

Barrel

Barrel

Spiral
V Cutter

Spiral
V Cutter

Drill

Drill

Technical Data

Technical Data



Size $\phi 0.2 \sim \phi 12$

CRN-ES2000



Material Applications (★ Highly Recommended ● Recommended ○ Suggested)

Work Material																	
Carbon Steels S45C S55C	Alloy Steels SK / SCM SUS	Prehardened Steels NAK HPM	Hardened Steels					Cast Iron	Aluminum Alloys	Graphite	Copper	Plastics	Glass Filled Plastics	Titanium Alloys	Heat Resistant Alloys	Cemented Carbide	Hard Brittle (Non-Metallic) Materials
			~50HRC	~55HRC	~60HRC	~65HRC	~70HRC										
										○	★	○					

Features

CrN COAT offers longer tool life.

Special geometry designed for Copper offers excellent milling performance.

Refer to page 232 for 4 flute CRN-ES.

Diameter Tolerance: $0/-0.02$ ($D \leq 6$), $0/-0.03$ ($D \geq 8$)

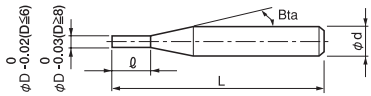

The shank taper angle shown is not an exact value and to avoid contact with the work piece, we recommend the user controls the precise value of this angle. Shank taper angle should not make contact with the work piece.

Total 26 models

Unit (mm)

Model Number	Outside Diameter ϕD	Length of Cut l	Shank Taper Angle Bta	Overall Length L	Shank Diameter ϕd	Suggested Retail Price ¥
CRN-ES 2002-0060	0.2	0.6	11°	40	4	6,100
CRN-ES 2003-0090	0.3	0.9	11°	40	4	6,100
CRN-ES 2004-0120	0.4	1.2	11°	40	4	6,100
CRN-ES 2005-0150	0.5	1.5	11°	40	4	3,200
CRN-ES 2005-0200		2		45	4	5,500
CRN-ES 2006-0180	0.6	1.8	11°	40	4	5,060
CRN-ES 2006-0240		2.4		45	4	5,500
CRN-ES 2008-0240	0.8	2.4	11°	40	4	3,200
CRN-ES 2010-0300	1	3	11°	45	4	3,200
CRN-ES 2010-0400		4		50	4	4,950
CRN-ES 2015-0450	1.5	4.5	11°	45	4	3,200
CRN-ES 2015-0600		6		50	4	4,950
CRN-ES 2020-0600	2	6	11°	45	4	3,200
CRN-ES 2020-0800		8		50	4	4,950
CRN-ES 2025-0750	2.5	7.5	11°	45	4	3,200
CRN-ES 2030-0900	3	9	11°	50	6	3,740
CRN-ES 2030-1200		12		55	6	6,050
CRN-ES 2040-1200	4	12	11°	50	6	3,960
CRN-ES 2040-1600		16		55	6	6,600
CRN-ES 2050-1500	5	15	11°	55	6	4,200
CRN-ES 2060-1800	6	18	—	60	6	4,620
CRN-ES 2060-2400		24		65	6	7,480
CRN-ES 2080-2400	8	24	—	80	8	8,760
CRN-ES 2100-3000	10	30	—	100	10	10,900
CRN-ES 2100-4000		40		100	10	17,280
CRN-ES 2120-3600	12	36	—	100	12	15,000

Milling Conditions for CRN-ES (2 Flutes)

◆3D flute length type

WORK MATERIAL		COPPER C1100						
		Side Milling				Slotting		
Model Number	Outside Diameter (mm)	Spindle Speed (min ⁻¹)	Feed Rate (mm/min)	a_p Axial Depth (mm)	a_e Radial Depth (mm)	Spindle Speed (min ⁻¹)	Feed Rate (mm/min)	a_p Axial Depth (mm)
2002-0060	0.2	40,000	100	0.3	0.004	40,000	85	0.01
2003-0090	0.3	38,000	100	0.45	0.006	38,000	85	0.015
2004-0120	0.4	35,000	100	0.6	0.008	35,000	85	0.02
2005-0150	0.5	32,000	120	0.75	0.01	32,000	100	0.025
2006-0180	0.6	29,000	150	0.9	0.012	26,000	120	0.03
2008-0240	0.8	22,000	180	1.2	0.016	21,000	150	0.04
2010-0300	1	18,000	180	1.5	0.02	16,000	150	0.05
2015-0450	1.5	17,500	250	2.25	0.15	11,000	150	0.15
2020-0600	2	17,000	340	3	0.2	7,500	150	0.2
2025-0750	2.5	16,500	450	3.75	0.25	6,000	150	0.25
2030-0900	3	16,000	630	4.5	0.3	5,000	170	0.3
2040-1200	4	12,000	650	6	0.4	5,000	200	0.4
2050-1500	5	10,000	750	7.5	0.5	5,000	250	0.5
2060-1800	6	8,000	800	9	0.6	4,500	250	0.6
2080-2400	8	6,000	700	12	0.8	4,000	250	0.8
2100-3000	10	5,000	600	15	1	4,000	350	1
2120-3600	12	4,000	500	18	1.2	4,000	450	1.2

◆4D flute length type

WORK MATERIAL		COPPER C1100						
		Side Milling				Slotting		
Model Number	Outside Diameter (mm)	Spindle Speed (min ⁻¹)	Feed Rate (mm/min)	a_p Axial Depth (mm)	a_e Radial Depth (mm)	Spindle Speed (min ⁻¹)	Feed Rate (mm/min)	a_p Axial Depth (mm)
2005-0200	0.5	16,000	60	1.25	0.005	16,000	50	0.025
2006-0240	0.6	14,500	75	1.5	0.006	14,500	65	0.03
2010-0400	1	9,000	90	2.5	0.01	8,000	75	0.05
2015-0600	1.5	9,000	150	3.75	0.075	8,000	130	0.15
2020-0800	2	5,000	140	5	0.1	4,500	120	0.2
2030-1200	3	3,500	140	7.5	0.15	2,500	85	0.3
2040-1600	4	3,500	200	10	0.2	2,500	100	0.4
2060-2400	6	3,000	200	15	0.3	2,500	150	0.6
2100-4000	10	2,500	230	25	0.5	2,000	175	1

Milling	Length of Cut	
	3D Flute Length Type	4D Flute Length Type
Side Milling	a_p 1.5D a_e 0.02D(D ≤ φ 1.0) a_e 0.1D(D > φ 1.0)	a_p 2.5D a_e 0.01D(D ≤ φ 1.0) a_e 0.05D(D > φ 1.0)
Slotting	a_p 0.05D(D ≤ φ 1.0) a_p 0.1D(D > φ 1.0)	a_p 0.05D(D ≤ φ 1.0) a_p 0.1D(D > φ 1.0)

Note:

- Decrease both spindle speed and feed rate proportionally in case of chattering.
- Adjust the milling amount and feed rate in accordance with required precision.
- Recommend water soluble or oil coolant.
- Recommended for Pure Copper. Not suitable for Tungsten Copper.

Side Milling

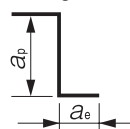

Slotting

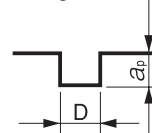

D : Outside Diameter (mm)

φ3mm Shank
V SeriesUDC-PCD
SeriesCBN
Series

Square

Long Neck
Square

Radius

Long Neck
RadiusTaper Neck
RadiusBall / Long
Shank BallLong Neck
BallTaper Neck
Ball

Taper

Barrel

Spiral
V Cutter

Drill

Technical Data



Size $\phi 0.2 \sim \phi 6$

DCES2000



Material Applications (★ Highly Recommended ● Recommended ○ Suggested)

Work Material																	
Carbon Steels S45C S55C	Alloy Steels SK / SCM SUS	Prehardened Steels NAK HPM	Hardened Steels					Cast Iron	Aluminum Alloys	Graphite	Copper	Plastics	Glass Filled Plastics	Titanium Alloys	Heat Resistant Alloys	Cemented Carbide	Hard Brittle (Non-Metallic) Materials
			~50HRC	~55HRC	~60HRC	~65HRC	~70HRC										
									○	★	○	○	●				○

Features

Diamond coated 2 Flute Square End Mills for Graphite Electrodes.

New Diamond coating, with a highly adhesive base layer, offers excellent wear resistance and longer tool life. Refer to page 234 for 4 flute DCES.

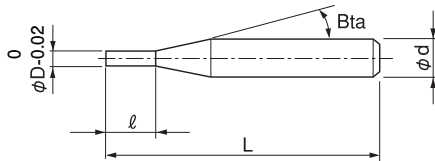

The shank taper angle shown is not an exact value and to avoid contact with the work piece, we recommend the user controls the precise value of this angle. Shank taper angle should not make contact with the work piece.

Total 8 models

Unit (mm)

Model Number	Outside Diameter ϕD	Length of Cut l	Shank Taper Angle Bta	Overall Length L	Shank Diameter ϕd	Suggested Retail Price ¥
DCES 2002-0060	0.2	0.6	16°	45	4	17,000
DCES 2005-0150	0.5	1.5	16°	45	4	14,500
DCES 2010-0300	1	3	16°	45	4	14,500
DCES 2015-0450	1.5	4.5	16°	45	4	14,500
DCES 2020-0600	2	6	16°	45	4	14,500
DCES 2030-0900	3	9	16°	45	6	17,000
DCES 2040-1200	4	12	16°	50	6	18,100
DCES 2060-1800	6	18	—	60	6	19,300

Milling Conditions for DCES (2 Flutes)

WORK MATERIAL			GRAPHITE				
Model Number	Outside Diameter (mm)	Length of Cut (mm)	Spindle Speed (min ⁻¹)	Feed Rate (mm/min)	Side Milling		Slotting
					a_p Axial Depth (mm)	a_e Radial Depth (mm)	a_p Axial Depth (mm)
2002-0060	0.2	0.6	30,000	1,000	0.6	0.01	0.006
2005-0150	0.5	1.5	30,000	1,100	1.5	0.025	0.02
2010-0300	1	3	28,000	1,300	3	0.05	0.05
2015-0450	1.5	4.5	25,000	1,500	4.5	0.075	0.12
2020-0600	2	6	24,000	1,800	6	0.1	0.15
2030-0900	3	9	25,000	2,600	9	0.15	0.3
2040-1200	4	12	19,000	2,000	12	0.24	0.6
2060-1800	6	18	13,000	1,500	18	0.36	1.2

Slotting

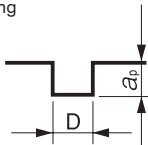

D : Outside Diameter (mm)

Side Milling

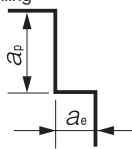

Note:

- Use a milling machine dedicated for Graphite.
- Recommend air blow for Graphite.

Other series for Graphite milling

Square / Long Neck Square

(★ Highly Recommended ● Recommended ○ Suggested)

Number of Flutes, Tool Type	Model Number	Appearance	Coating	Size	Aluminum Alloys	Graphite	Copper	Plastics	Glass Filled Plastics	Hard Brittle (Non-Metallic) Materials	Page
					○	★	○	○	○	●	
4 flutes Square	CGE		Non-coat	$\phi 2 \sim \phi 20$	○	★	○	○	○		236
2 flutes Square	DCES 2000		DIA	$\phi 0.2 \sim \phi 6$	○	★	○	○	●	○	188
4 flutes Square	DCES 4000		DIA	$\phi 3 \sim \phi 10$	○	★	○	○	●	○	234
2 flutes Long Neck Square	DCLS		DIA	$\phi 0.4 \sim \phi 6$	○	★	○	○	●	○	266

Long Neck Radius

4 flutes Long Neck Radius	DCLRS		DIA	$\phi 1 \sim \phi 6$	○	★	○	○	●	○	396
---------------------------	-------	--	-----	----------------------	---	---	---	---	---	---	-----

Ball / Long Neck Ball / Taper Neck Ball

2 flutes Ball	CGB 2000		Non-coat	R0.2~R6	○	★	○	○	○		440
4 flutes Ball	CGB 4000		Non-coat	R2~R10	○	★	○	○	○		458
2 flutes Ball	DCB		DIA	R0.5~R6	○	★	○	○	●	○	438
2 flutes Long Neck Ball	DCLB		DIA	R0.2~R3	○	★	○	○	●	○	512
2 flutes Taper Neck Ball	DCTNB		DIA	R0.5~R1	○	★	○	○	●	○	556

3mm Shank V Series

UDC-PCD Series

CBN Series

Square

Long Neck Square

Radius

Long Neck Radius

Taper Neck Radius

Ball / Long Shank Ball

Long Neck Ball

Taper Neck Ball

Taper

Barrel

Spiral V Cutter

Drill

Technical Data



Size $\phi 0.3 \sim \phi 12$

CPS



Material Applications (★ Highly Recommended ● Recommended ○ Suggested)

Work Material																	
Carbon Steels S45C S55C	Alloy Steels SK / SCM SUS	Prehardened Steels NAK HPM	Hardened Steels					Cast Iron	Aluminum Alloys	Graphite	Copper	Plastics	Glass Filled Plastics	Titanium Alloys	Heat Resistant Alloys	Cemented Carbide	Hard Brittle (Non-Metallic) Materials
			~50HRC	~55HRC	~60HRC	~65HRC	~70HRC										
											○	●	★				

Features

Medium length of cut design for Plastic milling.
 Original flute design offers excellent surface finish.
 Length of cut = outside diameter x3 (Note: outside diameter x1.5~2 is partially included).
 Provides excellent milling surface for long overhang milling on Plastics.

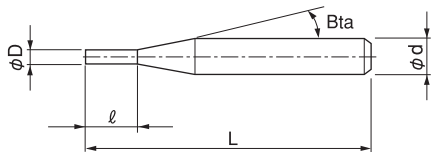

The shank taper angle shown is not an exact value and to avoid contact with the work piece, we recommend the user controls the precise value of this angle. Shank taper angle should not make contact with the work piece.

Total 23 models

Unit (mm)

Model Number	Outside Diameter ϕD	Length of Cut ℓ	Shank Taper Angle Bta	Overall Length L	Shank Diameter ϕd	Suggested Retail Price ¥
CPS 2003	0.3	0.9	16°	45	4	6,480
CPS 2004	0.4	1.2	16°	45	4	7,080
CPS 2005	0.5	1.5	16°	45	4	4,800
CPS 2006	0.6	1.8	16°	45	4	5,520
CPS 2007	0.7	2.1	16°	45	4	6,000
CPS 2008	0.8	2.4	16°	45	4	5,520
CPS 2009	0.9	2.7	16°	45	4	6,000
CPS 2010	1	3	16°	50	4	3,840
CPS 2012	1.2	3.6	16°	50	4	4,200
CPS 2015	1.5	4.5	16°	50	4	4,200
CPS 2020	2	6	16°	55	4	4,200
CPS 2025	2.5	7.5	16°	55	4	4,300
CPS 2030		9	16°	60	6	5,400
◎ CPS 2030SS	3	4.5	—	60	3	5,200
◎ CPS 2030SSL		6	—	100	3	7,800
CPS 2040		12	16°	60	6	5,400
◎ CPS 2040SS	4	6	—	60	4	5,200
◎ CPS 2040SSL		8	—	100	4	9,600
CPS 2050	5	15	16°	60	6	6,240
◎ CPS 2060	6	18	—	60	6	6,600
◎ CPS 2080	8	24	—	80	8	12,100
◎ CPS 2100	10	30	—	80	10	14,850
◎ CPS 2120	12	36	—	90	12	22,000

◎ Straight shank type

Milling Conditions for CPS

WORK MATERIAL			ABS / MC NYLON			ACRYLIC / POLYACETAL			POLYCARBONATE			GLASS FIBER REINFORCED POLYCARBONATE		
Model Number	Outside Diameter (mm)	Length of Cut (mm)	Spindle Speed (min ⁻¹)	Feed Rate (mm/min)	a_p Axial Depth (mm)	Spindle Speed (min ⁻¹)	Feed Rate (mm/min)	a_p Axial Depth (mm)	Spindle Speed (min ⁻¹)	Feed Rate (mm/min)	a_p Axial Depth (mm)	Spindle Speed (min ⁻¹)	Feed Rate (mm/min)	a_p Axial Depth (mm)
2003	0.3	0.9	20,000	320	0.3	16,000	160	0.3	16,000	130	0.2	16,000	260	0.2
2004	0.4	1.2	20,000	400	0.4	16,000	160	0.4	16,000	130	0.2	16,000	260	0.3
2005	0.5	1.5	20,000	480	0.5	16,000	160	0.5	16,000	130	0.3	16,000	320	0.4
2006	0.6	1.8	20,000	600	0.6	16,000	200	0.5	16,000	130	0.3	16,000	390	0.5
2007	0.7	2.1	20,000	720	0.7	16,000	260	0.6	16,000	160	0.4	16,000	390	0.6
2008	0.8	2.4	20,000	800	0.8	16,000	320	0.7	16,000	160	0.4	15,200	430	0.6
2009	0.9	2.7	20,000	880	0.9	14,200	340	0.8	14,200	170	0.5	14,200	460	0.7
2010	1	3	20,000	1,000	1	14,100	430	0.9	14,100	290	0.5	14,100	510	0.8
2012	1.2	3.6	20,000	1,080	1.2	14,100	480	1.1	14,100	340	0.6	14,100	650	1
2015	1.5	4.5	20,000	1,160	1.5	12,800	460	1.4	12,800	390	0.8	13,200	740	1.2
2020	2	6	20,000	1,200	2	12,800	510	1.6	12,500	430	0.6	13,100	740	1.4
2025	2.5	7.5	20,000	1,200	2.5	12,800	570	2	10,200	450	0.8	12,700	760	1.8
2030	3	9	20,000	1,200	3	12,800	640	2.4	9,600	430	0.9	10,700	810	2.1
2030SS	3	4.5	20,000	1,200	3	12,800	640	2.4	9,600	430	0.9	10,700	810	2.1
2030SSL	3	6	20,000	1,200	3	12,800	640	2.4	9,600	430	0.9	10,700	810	2.1
2040	4	12	14,900	1,200	4	12,000	600	3.2	8,000	400	1.2	8,000	770	2.8
2040SS	4	6	14,900	1,200	4	12,000	600	3.2	8,000	400	1.2	8,000	770	2.8
2040SSL	4	8	14,900	1,200	4	12,000	600	3.2	8,000	400	1.2	8,000	770	2.8
2050	5	15	12,000	960	5	9,600	480	4	6,400	320	1.5	6,400	620	3.5
2060	6	18	10,000	800	6	8,000	400	4.8	5,400	270	1.8	5,400	510	4.2
2080	8	24	7,500	600	8	6,000	300	6.4	4,000	200	2.4	4,000	390	5.6
2100	10	30	6,000	480	10	4,800	240	8	3,200	160	3	3,200	310	7
2120	12	36	5,000	400	12	4,000	200	9.6	2,700	140	3.6	2,700	260	8.4

Milling Amount for Slotting (mm)

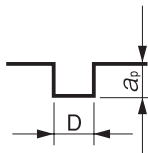

D : Outside Diameter (mm)

CPS finishing conditions for side milling

Refer to the slotting parameters for spindle speed and feed rate.
Set the milling amount as below during side milling finishing.

Milling Amount for Side Finishing (mm)

 a_e : 0.01 ~ 0.015D (Min 0.01 mm)

D : Outside Diameter (mm)

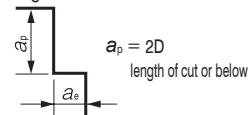

- Note:
- Control the radial depth (a_e) by approximately 0.01-0.015 times of the outside diameter or set to 0.01 mm the minimum during side milling finishing.
 - Increase the feed rate per flute to reduce burring on surface of softer materials.
 - Chattering may occur when using a spindle with low rigidity or when milling unstable work piece. Reduce the milling amount in this case.
 - Recommend to reduce the milling amount when using a machine with low spindle speed. Not recommend to reduce the feed rate.
 - Adjust the milling parameters based on the overhang length.
 - Recommend water soluble coolant for Aluminum Alloys and Copper.
 - Recommend air blow for Plastics.
 - Remove chips from the work piece to keep the milling surface quality.
 - If chips clog on the tool, stop the operation and remove them accordingly.
 - Straight shank type (2030SS, 2030SSL, 2040SS, 2040SSL, etc.) has smaller outside diameter than shank diameter. Prevent the shank making contact with the work piece.

Ø3mm Shank V Series

UDC-PCD Series

CBN Series

Square

Long Neck Square

Radius

Long Neck Radius

Taper Neck Radius

Ball / Long Shank Ball

Long Neck Ball

Taper Neck Ball

Taper

Barrel

Spiral V Cutter

Drill

Technical Data



Size $\phi 0.5 \sim \phi 12$

CAS



Material Applications (★ Highly Recommended ● Recommended ○ Suggested)

Work Material																	
Carbon Steels S45C S55C	Alloy Steels SK / SCM SUS	Prehardened Steels NAK HPM	Hardened Steels					Cast Iron	Aluminum Alloys	Graphite	Copper	Plastics	Glass Filled Plastics	Titanium Alloys	Heat Resistant Alloys	Cemented Carbide	Hard Brittle (Non-Metallic) Materials
			~50HRC	~55HRC	~60HRC	~65HRC	~70HRC										
								★			○						

Features

Designed especially for Aluminum milling.

45° helix angle design offers excellent cutting performance and outstanding chip evacuation.

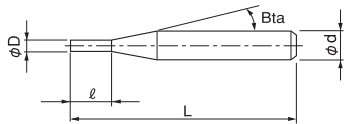

The shank taper angle shown is not an exact value and to avoid contact with the work piece, we recommend the user controls the precise value of this angle. Shank taper angle should not make contact with the work piece.

Total 19 models

Unit (mm)

Model Number	Outside Diameter ϕD	Length of Cut ℓ	Shank Taper Angle Bta	Overall Length L	Shank Diameter ϕd	Suggested Retail Price \yen
CAS 2005-0075	0.5	0.75	16°	45	4	4,030
CAS 2010-0150	1	1.5	16°	45	4	3,480
CAS 2015-0225	1.5	2.25	16°	45	4	3,480
CAS 2020-0300	2	3	16°	45	4	3,480
CAS 2025-0375	2.5	3.75	16°	50	6	4,560
CAS 2030-0450	3	4.5	16°	50	6	4,560
CAS 2030-0900		9		50	6	6,300
CAS 2040-0600	4	6	16°	50	6	4,680
CAS 2040-1200		12		50	6	6,510
CAS 2050-0750	5	7.5	16°	50	6	5,160
CAS 2050-1500		15		50	6	7,440
CAS 2060-0900	6	9	—	50	6	5,400
CAS 2060-1500		15		50	6	7,560
CAS 2080-1200	8	12	—	80	8	7,680
CAS 2080-2000		20		80	8	10,440
CAS 2100-1500	10	15	—	80	10	10,080
CAS 2100-2500		25		80	10	13,200
CAS 2120-1800	12	18	—	90	12	14,640
CAS 2120-3000		30		90	12	18,600

Milling Conditions for CAS

◆ Slotting

WORK MATERIAL		ALUMINUM ALLOYS etc. A5052 etc.			
Model Number	Outside Diameter (mm)	Spindle Speed (min ⁻¹)	Feed Rate (mm/min)	a_p Axial Depth (mm)	
2005-0075	0.5	25,000	250	0.75	
2010-0150	1	25,000	500	1.5	
2015-0225	1.5	25,000	750	2.25	
2020-0300	2	22,000	880	3	
2025-0375	2.5	19,000	950	3.75	
2030-0450	3	16,000	1,600	1.5	
2040-0600	4	12,000	1,200	2	
2050-0750	5	9,600	1,920	2.5	
2060-0900	6	8,000	1,600	3	
2080-1200	8	6,000	1,200	4	
2100-1500	10	12,000	2,400	5	
2120-1800	12	10,000	2,000	6	
Milling Amount (mm)		$D \leq 2.5$	$a_p = 1.5D$		
		$D \geq 3$	$a_p = 0.5D$		

◆ High speed milling

WORK MATERIAL		ALUMINUM ALLOYS etc. A5052 etc.			
Model Number	Outside Diameter (mm)	Spindle Speed (min ⁻¹)	Feed Rate (mm/min)	a_p Axial Depth (mm)	a_e Radial Depth (mm)
2030-0450	3	20,000	4,000	4.5	0.6
2040-0600	4	18,200	3,640	6	0.8
2050-0750	5	17,000	3,400	7.5	1
2060-0900	6	16,000	3,200	9	1.2
2080-1200	8	14,400	2,880	12	1.6
2100-1500	10	13,200	2,640	15	2
2120-1800	12	12,000	2,400	18	2.4
Milling Amount (mm)		$a_p = 1.5D$ $a_e = 0.2D$			

◆ Side milling

WORK MATERIAL			ALUMINUM ALLOYS etc. A5052 etc.			
Model Number	Outside Diameter (mm)	Length of Cut (mm)	Spindle Speed (min ⁻¹)	Feed Rate (mm/min)	a_p Axial Depth (mm)	a_e Radial Depth (mm)
2005-0075	0.5	0.75	25,000	1,000	0.75	0.15
2010-0150	1	1.5	25,000	1,250	1.5	0.3
2015-0225	1.5	2.25	25,000	1,500	2.25	0.45
2020-0300	2	3	22,000	1,760	3	0.6
2025-0375	2.5	3.75	19,000	1,900	3.75	0.75
2030-0450	3	4.5	16,000	3,200	4.5	0.6
2030-0900		9			4.5	0.6
2040-0600	4	6	12,000	2,400	6	0.8
2040-1200		12			6	0.8
2050-0750	5	7.5	9,600	1,920	7.5	1
2050-1500		15			7.5	1
2060-0900	6	9	8,000	1,600	9	1.2
2060-1500		15			9	1.2
2080-1200	8	12	6,000	1,200	12	1.6
2080-2000		20			12	1.6
2100-1500	10	15	4,800	960	15	2
2100-2500		25			15	2
2120-1800	12	18	4,000	800	18	2.4
2120-3000		30			18	2.4
Milling Amount (mm)			$D \leq 2.5$	$a_p = 1.5D$	$a_e = 0.3D$	
			$D \geq 3$	$a_p = 1.5D$	$a_e = 0.2D$	

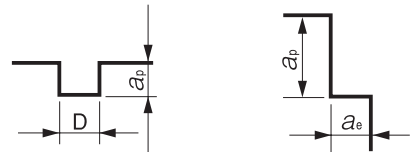

D : Outside Diameter (mm)

Note:

- Recommend using a non-contact measuring device to avoid damaging the sharp corner.
- Recommend side milling for finishing.
- Recommend water soluble coolant.

Ø3mm Shank
V Series

UDC-PCD
Series

CBN
Series

Square
Long Neck
Square

Radius
Long Neck
Radius

Taper Neck
Radius

Ball / Long
Shank Ball

Long Neck
Ball

Taper Neck
Ball

Taper

Barrel

Spiral
V Cutter

Drill

Technical Data



Size $\phi 1 \sim \phi 20$

C-CES4000



Material Applications (★ Highly Recommended ● Recommended ○ Suggested)

Work Material																	
Carbon Steels S45C S55C	Alloy Steels SK / SCM SUS	Prehardened Steels NAK HPM	Hardened Steels					Cast Iron	Aluminum Alloys	Graphite	Copper	Plastics	Glass Filled Plastics	Titanium Alloys	Heat Resistant Alloys	Cemented Carbide	Hard Brittle (Non-Metallic) Materials
			~50HRC	~55HRC	~60HRC	~65HRC	~70HRC										
●	●	●	●	○						●			○	○			

Features

**Broad application range from Copper and Carbon Steels up to Hardened Steels (55HRC).
Excellent performance/quality to price ratio.
Refer to page 166 for 2 flute C-CES.**

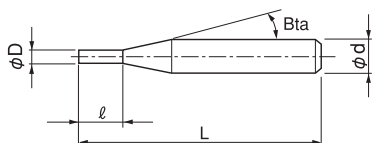

The shank taper angle shown is not an exact value and to avoid contact with the work piece, we recommend the user controls the precise value of this angle. Shank taper angle should not make contact with the work piece. Actual measurement is necessary when using longer length of cut than the written length.

Total 56 models

Unit (mm)

Model Number	Outside Diameter ϕD	Length of Cut ℓ	Shank Taper Angle Bta	Overall Length L	Shank Diameter ϕd	Suggested Retail Price \yen
C-CES 4010	1	2.5	16°	45	4	5,160
C-CES 4010-0300		3		45	4	5,160
C-CES 4010-0400		4		45	4	5,400
C-CES 4015	1.5	3.75	16°	45	4	5,160
C-CES 4015-0450		4.5		45	4	5,160
C-CES 4015-0600		6		45	4	5,400
C-CES 4020	2	5	16°	45	4	3,300
C-CES 4020-0600		6		45	4	3,300
C-CES 4020-0800		8		45	4	4,440
C-CES 4025	2.5	6.25	16°	45	4	3,300
C-CES 4025-0750		7.5		50	4	3,300
C-CES 4025-1000		10		50	4	4,440
C-CES 4030-0750	3	7.5	16°	45	6	3,420
C-CES 4030		8		45	6	3,420
C-CES 4030-0900		9		50	6	3,420
C-CES 4030-1200		12		50	6	4,320
C-CES 4035	3.5	10	16°	45	6	7,150

Unit (mm)

Model Number	Outside Diameter ϕD	Length of Cut ℓ	Shank Taper Angle Bta	Overall Length L	Shank Diameter ϕd	Suggested Retail Price ¥
C-CES 4040	4	11	16°	45	6	3,860
C-CES 4040-1200		12		60	6	3,860
C-CES 4040-1600		16		60	6	5,160
C-CES 4045	4.5	11	16°	45	6	8,400
C-CES 4050-1250	5	12.5	16°	50	6	3,970
C-CES 4050		13		50	6	3,970
C-CES 4050-1500		15		60	6	3,970
C-CES 4050-2000		20		60	6	5,520
C-CES 4055	5.5	13	16°	50	6	8,610
C-CES 4060	6	13	—	50	6	4,170
C-CES 4060-1500		15		50	6	4,170
C-CES 4060-1800		18		60	6	4,170
C-CES 4060-2400		24		60	6	6,000
C-CES 4065	6.5	16	16°	60	8	11,660
C-CES 4070	7	16	16°	60	8	10,360
C-CES 4075	7.5	16	16°	60	8	12,540
C-CES 4080	8	19	—	60	8	7,090
C-CES 4080-2000		20		60	8	7,090
C-CES 4080-2400		24		80	8	7,090
C-CES 4080-3200		32		80	8	15,000
C-CES 4085	8.5	19	16°	70	10	15,180
C-CES 4090	9	19	16°	70	10	13,650
C-CES 4095	9.5	19	16°	70	10	17,160
C-CES 4100	10	22	—	70	10	9,460
C-CES 4100-2500		25		70	10	9,460
C-CES 4100-3000		30		90	10	9,460
C-CES 4100-4000		40		90	10	16,560
C-CES 4105	10.5	22	16°	75	12	20,900
C-CES 4110	11	22	16°	75	12	20,900
C-CES 4115	11.5	22	16°	75	12	22,440
C-CES 4120	12	26	—	75	12	11,880
C-CES 4120-3000		30		75	12	11,880
C-CES 4120-3600		36		90	12	11,880
C-CES 4120-4800		48		100	12	25,200
C-CES 4120-5000		50		100	12	25,200
C-CES 4140	14	26	—	80	12	29,150
C-CES 4160	16	32	—	110	16	46,200
C-CES 4180	18	32	16°	110	20	62,150
C-CES 4200	20	38	—	110	20	68,200

4 Flutes

$\phi 3$ mm Shank
V Series

UDC-PCD
Series

CBN
Series

Square

Long Neck
Square

Radius

Long Neck
Radius

Taper Neck
Radius

Ball / Long
Shank Ball

Long Neck
Ball

Taper Neck
Ball

Taper

Barrel

Spiral
V Cutter

Drill

Technical Data

Milling Conditions for C-CES (4 Flutes)

WORK MATERIAL			CARBON STEELS S45C / S50C (~225HB)				ALLOY STEELS SK / SCM / SUS (225~325HB)			
			Side Milling				Side Milling			
Model Number	Outside Diameter (mm)	Length of Cut (mm)	Spindle Speed (min ⁻¹)	Feed Rate (mm/min)	a _{ax} Axial Depth (mm)	a _{re} Radial Depth (mm)	Spindle Speed (min ⁻¹)	Feed Rate (mm/min)	a _{ax} Axial Depth (mm)	a _{re} Radial Depth (mm)
4010	1	2.5	20,000	240	2	0.07	15,000	215	2	0.07
		3			2.5	0.05			2.5	0.05
		4			3.5	0.02			3.5	0.02
4015	1.5	3.75	13,500	245	3	0.105	10,000	215	3	0.105
		4.5			3.75	0.075			3.75	0.075
		6			5.25	0.03			5.25	0.03
4020	2	5	11,000	245	4	0.14	8,500	215	4	0.14
		6			5	0.1			5	0.1
		8			7	0.04			7	0.04
4025	2.5	6.25	8,800	370	5	0.175	7,000	245	5	0.175
		7.5			6.25	0.125			6.25	0.125
		10			8.75	0.05			8.75	0.05
4030	3	7.5	7,400	370	6	0.21	6,400	260	6	0.21
		8			7.5	0.15			7.5	0.15
		9			7.5	0.15			7.5	0.15
		12			10.5	0.06			10.5	0.06
4040	4	11	5,900	435	10	0.2	5,000	340	10	0.2
		12			10	0.2			10	0.2
		16			14	0.08			14	0.08
4050	5	12.5	5,300	590	10	0.35	4,200	415	10	0.35
		13			12.5	0.25			12.5	0.25
		15			12.5	0.25			12.5	0.25
		20			17.5	0.1			17.5	0.1
4060	6	13	4,400	580	12	0.42	3,500	415	12	0.42
		15			12	0.42			12	0.42
		18			15	0.3			15	0.3
		24			21	0.12			21	0.12
4080	8	19	3,300	550	16	0.56	2,600	415	16	0.56
		20			16	0.56			16	0.56
		24			20	0.4			20	0.4
		32			28	0.16			28	0.16
4100	10	22	2,600	525	20	0.7	2,100	405	20	0.7
		25			20	0.7			20	0.7
		30			25	0.5			25	0.5
		40			35	0.2			35	0.2
4120	12	26	2,200	525	24	0.84	1,750	405	24	0.84
		30			24	0.84			24	0.84
		36			30	0.6			30	0.6
		48			42	0.24			42	0.24
		50			42	0.24			42	0.24

- φ3mm Shank V Series
- UDC-PCD Series
- CBN Series
- Square
- Long Neck Square
- Radius
- Long Neck Radius
- Taper Neck Radius
- Ball / Long Shank Ball
- Long Neck Ball
- Taper Neck Ball
- Taper
- Barrel
- Spiral V Cutter
- Drill
- Technical Data

Milling Conditions for C-CES (4 Flutes)

WORK MATERIAL			PREHARDENED STEELS / HARDENED STEELS NAK / SKD (30~45HRC)				HARDENED STEELS SKD / SKT (45~55HRC)			
			Side Milling				Side Milling			
Model Number	Outside Diameter (mm)	Length of Cut (mm)	Spindle Speed (min ⁻¹)	Feed Rate (mm/min)	a ₀ Axial Depth (mm)	a _e Radial Depth (mm)	Spindle Speed (min ⁻¹)	Feed Rate (mm/min)	a ₀ Axial Depth (mm)	a _e Radial Depth (mm)
4010	1	2.5	11,000	85	2	0.07	7,100	40	1.5	0.03
		3			2.5	0.05			2	0.02
		4			3.5	0.02			3	0.01
4015	1.5	3.75	8,000	90	3	0.105	5,100	50	2.25	0.045
		4.5			3.75	0.075			3	0.03
		6			5.25	0.03			4.5	0.015
4020	2	5	6,400	90	4	0.14	4,000	55	3	0.06
		6			5	0.1			4	0.04
		8			7	0.04			6	0.02
4025	2.5	6.25	5,000	90	5	0.175	3,200	55	3.75	0.075
		7.5			6.25	0.125			5	0.05
		10			8.75	0.05			7.5	0.025
4030	3	7.5	4,500	105	6	0.21	2,800	65	4.5	0.09
		8			7.5	0.15			6	0.06
		9			7.5	0.15			6	0.06
		12			10.5	0.06			9	0.03
4040	4	11	3,500	120	10	0.2	2,150	70	8	0.08
		12			10	0.2			8	0.08
		16			14	0.08			12	0.04
4050	5	12.5	2,950	120	10	0.35	1,850	75	7.5	0.15
		13			12.5	0.25			10	0.1
		15			12.5	0.25			10	0.1
		20			17.5	0.1			15	0.05
4060	6	13	2,450	130	12	0.42	1,500	70	9	0.18
		15			12	0.42			9	0.18
		18			15	0.3			12	0.12
		24			21	0.12			18	0.06
4080	8	19	1,850	125	16	0.56	1,200	70	12	0.24
		20			16	0.56			12	0.24
		24			20	0.4			16	0.16
		32			28	0.16			24	0.08
4100	10	22	1,450	125	20	0.7	950	65	15	0.3
		25			20	0.7			15	0.3
		30			25	0.5			20	0.2
		40			35	0.2			30	0.1
4120	12	26	1,200	120	24	0.84	800	60	18	0.36
		30			24	0.84			18	0.36
		36			30	0.6			24	0.24
		48			42	0.24			36	0.12
		50			42	0.24			36	0.12

4 Flutes

Ø3mm Shank
V Series

UDC-PCD
Series

CBN
Series

Square

Long Neck
Square

Radius

Long Neck
Radius

Taper Neck
Radius

Ball / Long
Shank Ball

Long Neck
Ball

Taper Neck
Ball

Taper

Barrel

Spiral
V Cutter

Drill

Technical Data

Milling Conditions for C-CES (4 Flutes)

◆High speed milling

WORK MATERIAL			CARBON STEELS S45C / S50C (~225HB)				ALLOY STEELS SK / SCM / SUS (225~325HB)			
			Side Milling				Side Milling			
Model Number	Outside Diameter (mm)	Length of Cut (mm)	Spindle Speed (min ⁻¹)	Feed Rate (mm/min)	a _{ax} Axial Depth (mm)	a _{re} Radial Depth (mm)	Spindle Speed (min ⁻¹)	Feed Rate (mm/min)	a _{ax} Axial Depth (mm)	a _{re} Radial Depth (mm)
4030	3	7.5	30,000	1,500	6	0.21	26,500	1,075	6	0.21
		8			7.5	0.15			7.5	0.15
		9			7.5	0.15			7.5	0.15
		12			10.5	0.06			10.5	0.06
4040	4	11	23,800	1,755	10	0.2	19,800	1,345	10	0.2
		12			10	0.2			10	0.2
		16			14	0.08			14	0.08
4050	5	12.5	19,000	2,115	10	0.35	15,800	1,560	10	0.35
		13			12.5	0.25			12.5	0.25
		15			12.5	0.25			12.5	0.25
		20			17.5	0.1			17.5	0.1
4060	6	13	15,900	2,095	12	0.42	13,200	1,565	12	0.42
		15			12	0.42			12	0.42
		18			15	0.3			15	0.3
		24			21	0.12			21	0.12
4080	8	19	11,900	1,985	16	0.56	9,900	1,580	16	0.56
		20			16	0.56			16	0.56
		24			20	0.4			20	0.4
		32			28	0.16			28	0.16
4100	10	22	9,500	1,920	20	0.7	7,900	1,525	20	0.7
		25			20	0.7			20	0.7
		30			25	0.5			25	0.5
		40			35	0.2			35	0.2
4120	12	26	7,900	1,885	24	0.84	6,600	1,525	24	0.84
		30			24	0.84			24	0.84
		36			30	0.6			30	0.6
		48			42	0.24			42	0.24
		50			42	0.24			42	0.24

φ3mm Shank
V SeriesUDC-PCD
SeriesCBN
Series

Square

Square
Long Neck
Square

Radius

Radius
Long Neck
RadiusTaper Neck
RadiusBall / Long
Shank BallBall
Long Neck
BallTaper Neck
Ball

Taper

Taper

Barrel

Spiral
V Cutter

Drill

Technical Data

Milling Conditions for C-CES (4 Flutes)

WORK MATERIAL			PREHARDENED STEELS / HARDENED STEELS NAK / SKD (30~45HRC)				HARDENED STEELS SKD / SKT (45~55HRC)			
			Side Milling				Side Milling			
Model Number	Outside Diameter (mm)	Length of Cut (mm)	Spindle Speed (min ⁻¹)	Feed Rate (mm/min)	a _p Axial Depth (mm)	a _e Radial Depth (mm)	Spindle Speed (min ⁻¹)	Feed Rate (mm/min)	a _p Axial Depth (mm)	a _e Radial Depth (mm)
4030	3	7.5	21,200	495	6	0.21	15,800	365	4.5	0.09
		8			7.5	0.15			6	0.06
		9			7.5	0.15			6	0.06
		12			10.5	0.06			9	0.03
4040	4	11	15,800	540	10	0.2	11,900	385	8	0.08
		12			10	0.2			8	0.08
		16			14	0.08			12	0.04
4050	5	12.5	12,700	515	10	0.35	9,500	385	7.5	0.15
		13			12.5	0.25			10	0.1
		15			12.5	0.25			10	0.1
		20			17.5	0.1			15	0.05
4060	6	13	10,600	560	12	0.42	7,900	370	9	0.18
		15			12	0.42			9	0.18
		18			15	0.3			12	0.12
		24			21	0.12			18	0.06
4080	8	19	7,900	535	16	0.56	5,900	345	12	0.24
		20			16	0.56			12	0.24
		24			20	0.4			16	0.16
		32			28	0.16			24	0.08
4100	10	22	6,300	545	20	0.7	4,700	320	15	0.3
		25			20	0.7			15	0.3
		30			25	0.5			20	0.2
		40			35	0.2			30	0.1
4120	12	26	5,300	530	24	0.84	3,900	295	18	0.36
		30			24	0.84			18	0.36
		36			30	0.6			24	0.24
		48			42	0.24			36	0.12
		50			42	0.24			36	0.12

Milling amount (mm)

Work Material	Length of Cut	2.5D or below	3D or below	4D or above
	45HRC or below		a _p =2D a _e =0.07D	a _p =2.5D a _e =0.05D
45HRC or above		a _p =1.5D a _e =0.03D	a _p =2D a _e =0.02D	a _p =3D a _e =0.01D

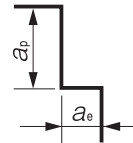

D : Outside Diameter (mm)

Ex.) 2D or below : Flute Length = Diameter × 2 or below

Note:

- Recommend water soluble or oil coolant.
- Recommend oil coolant for Titanium Alloys and Heat Resistant Alloys.

4 Flutes

Ø3mm Shank
V Series

UDC-PCD
Series

CBN
Series

Square

Long Neck
Square

Radius

Long Neck
Radius

Taper Neck
Radius

Ball / Long
Shank Ball

Long Neck
Ball

Taper Neck
Ball

Taper

Barrel

Spiral
V Cutter

Drill

Technical Data



Size $\phi 1 \sim \phi 12$

C-CES4000S



Material Applications (★ Highly Recommended ● Recommended ○ Suggested)

Work Material																	
Carbon Steels S45C S55C	Alloy Steels SK / SCM SUS	Prehardened Steels NAK HPM	Hardened Steels					Cast Iron	Aluminum Alloys	Graphite	Copper	Plastics	Glass Filled Plastics	Titanium Alloys	Heat Resistant Alloys	Cemented Carbide	Hard Brittle (Non-Metallic) Materials
			~50HRC	~55HRC	~60HRC	~65HRC	~70HRC										
●	●	●	●	○				○			●			○	○		

Features

4 flute C-CES with a sharp corner design.

Broad application range from Copper and Carbon Steels up to Hardened Steels (55HRC).

Excellent performance / quality to price ratio.

Refer to page 180 for 2 flute C-CES-S.

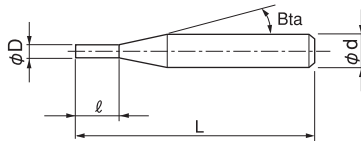

The shank taper angle shown is not an exact value and to avoid contact with the work piece, we recommend the user controls the precise value of this angle. Shank taper angle should not make contact with the work piece.

Total 11 models

Unit (mm)

Model Number	Outside Diameter ϕD	Length of Cut ℓ	Shank Taper Angle Bta	Overall Length L	Shank Diameter ϕd	Suggested Retail Price ¥
C-CES 4010S	1	2.5	16°	45	4	5,160
C-CES 4015S	1.5	3.75	16°	45	4	5,160
C-CES 4020S	2	6	16°	45	4	3,300
C-CES 4025S	2.5	6.25	16°	45	4	3,300
C-CES 4030S	3	8	16°	45	6	3,420
C-CES 4040S	4	11	16°	45	6	3,860
C-CES 4050S	5	13	16°	50	6	3,970
C-CES 4060S	6	13	—	50	6	4,170
C-CES 4080S	8	19	—	60	8	7,090
C-CES 4100S	10	22	—	70	10	9,460
C-CES 4120S	12	26	—	75	12	11,880

Milling Conditions for C-CES-S (4 Flutes)

WORK MATERIAL		CARBON STEELS S45C / S50C (~225HB)				ALLOY STEELS SK / SCM / SUS (225~325HB)			
		Side Milling				Side Milling			
Model Number	Outside Diameter (mm)	Spindle Speed (min ⁻¹)	Feed Rate (mm/min)	a _p Axial Depth (mm)	a _e Radial Depth (mm)	Spindle Speed (min ⁻¹)	Feed Rate (mm/min)	a _p Axial Depth (mm)	a _e Radial Depth (mm)
4010S	1	20,000	170	2	0.07	13,700	150	2	0.07
4015S	1.5	13,400	190	3	0.105	9,100	160	3	0.105
4020S	2	11,600	200	4	0.14	5,600	170	4	0.14
4025S	2.5	9,300	300	5	0.175	4,200	190	5	0.175
4030S	3	8,800	340	6	0.21	6,700	210	6	0.21
4040S	4	6,600	370	8	0.28	5,000	270	8	0.28
4050S	5	5,300	450	10	0.35	4,000	320	10	0.35
4060S	6	4,400	450	12	0.42	3,300	320	12	0.42
4080S	8	3,300	420	16	0.56	2,500	300	16	0.56
4100S	10	2,650	410	20	0.7	2,000	300	20	0.7
4120S	12	2,200	400	24	0.84	1,700	300	24	0.84

WORK MATERIAL		PREHARDENED STEELS / HARDENED STEELS NAK / SKD (30~45HRC)				HARDENED STEELS SKD / SKT (45~55HRC)			
		Side Milling				Side Milling			
Model Number	Outside Diameter (mm)	Spindle Speed (min ⁻¹)	Feed Rate (mm/min)	a _p Axial Depth (mm)	a _e Radial Depth (mm)	Spindle Speed (min ⁻¹)	Feed Rate (mm/min)	a _p Axial Depth (mm)	a _e Radial Depth (mm)
4010S	1	7,300	55	2	0.07	1,600	15	1.5	0.03
4015S	1.5	4,900	60	3	0.105	1,100	15	2.25	0.045
4020S	2	5,300	65	4	0.14	2,400	30	3	0.06
4025S	2.5	4,200	70	5	0.175	1,900	35	3.75	0.075
4030S	3	4,600	90	6	0.21	2,700	50	4.5	0.09
4040S	4	3,400	100	8	0.28	2,000	55	6	0.12
4050S	5	2,700	110	10	0.35	1,600	60	7.5	0.15
4060S	6	2,300	110	12	0.42	1,300	60	9	0.18
4080S	8	1,700	100	16	0.56	1,000	50	12	0.24
4100S	10	1,400	100	20	0.7	800	50	15	0.3
4120S	12	1,150	90	24	0.84	700	45	18	0.36

Milling Amount for side milling (mm)

45HRC or below	a _p =2D a _e =0.07D
45HRC or above	a _p =1.5D a _e =0.03D

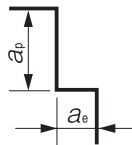

D : Outside Diameter (mm)

Note:

- Recommend water soluble or oil coolant.
- Recommend oil coolant for Titanium Alloys and Heat Resistant Alloys.

4 Flutes

Ø3mm Shank
V Series

UDC-PCD
Series

CBN
Series

Square

Square

Long Neck
Square

Radius

Radius

Long Neck
Radius

Taper Neck
Radius

Ball

Ball / Long
Shank Ball

Long Neck
Ball

Taper Neck
Ball

Taper

Taper

Barrel

Spiral
V Cutter

Drill

Technical Data

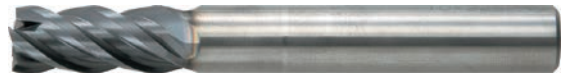

Size $\phi 1 \sim \phi 20$

CZS

Super
MG

UT
COAT

40°

Flatland

Shank Dia
0/-0.005

Variable
Pitch

Patented in Japan, China, Taiwan, Korea, Germany, Switzerland, and Liechtenstein

Material Applications (★ Highly Recommended ● Recommended ○ Suggested)

Work Material																	
Carbon Steels S45C S55C	Alloy Steels SK / SCM SUS	Prehardened Steels NAK HPM	Hardened Steels					Cast Iron	Aluminum Alloys	Graphite	Copper	Plastics	Glass Filled Plastics	Titanium Alloys	Heat Resistant Alloys	Cemented Carbide	Hard Brittle (Non-Metallic) Materials
			~50HRC	~55HRC	~60HRC	~65HRC	~70HRC										
●	●	●	●	○				○	○		●			○	○		

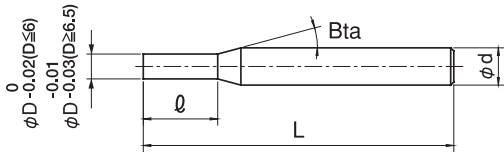

The shank taper angle shown is not an exact value and to avoid contact with the work piece, we recommend the user controls the precise value of this angle. Shank taper angle should not make contact with the work piece. Actual measurement is necessary when using longer length of cut than the written length.

Drilling and Milling in a Single Tool! 1/2 Cycle Time!



Drilling and Milling in a Single Tool

The unique design of the bottom edge offers the drilling process with 4 flutes

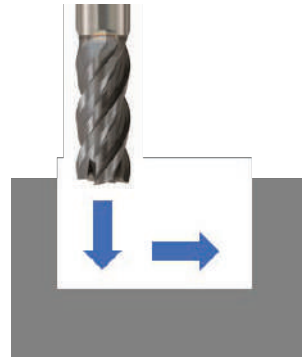
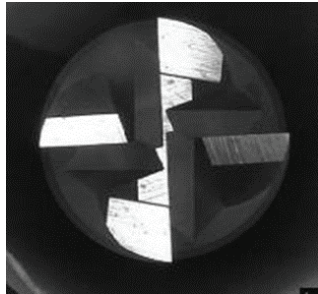

- φ3mm Shank V Series
- UDC-PCD Series
- CBN Series
- Square
- Long Neck Square
- Radius
- Long Neck Radius
- Taper Neck Radius
- Ball / Long Shank Ball
- Long Neck Ball
- Taper Neck Ball
- Taper
- Barrel
- Spiral V Cutter
- Drill
- Technical Data

Total 89 models

Unit (mm)

Model Number	Outside Diameter ϕD	Length of Cut ℓ	Shank Taper Angle Bta	Overall Length L	Shank Diameter ϕd	Suggested Retail Price ¥
CZS 4010-0150	1	1.5	16°	50	4	6,900
CZS 4010-0250		2.5		50		
CZS 4011-0250	1.1	2.5	16°	50	4	8,630
CZS 4012-0250	1.2	2.5	16°	50	4	8,630
CZS 4013-0300	1.3	3	16°	50	4	8,630
CZS 4014-0300	1.4	3	16°	50	4	8,630
CZS 4015-0225	1.5	2.25	16°	50	4	6,900
CZS 4015-0400		4		50		
CZS 4016-0400	1.6	4	16°	50	4	8,630
CZS 4017-0400	1.7	4	16°	50	4	8,630
CZS 4018-0400	1.8	4	16°	50	4	8,630
CZS 4019-0400	1.9	4	16°	50	4	8,630
CZS 4020-0300	2	3	16°	50	4	6,300
CZS 4020-0600		6		50		
CZS 4021-0600	2.1	6	16°	50	4	7,870
CZS 4022-0600	2.2	6	16°	50	4	7,870
CZS 4023-0600	2.3	6	16°	50	4	7,870
CZS 4024-0600	2.4	6	16°	50	4	7,870
CZS 4025-0375	2.5	3.75	16°	50	4	6,300
CZS 4025-0800		8		50		
CZS 4026-0800	2.6	8	16°	50	4	7,870
CZS 4027-0800	2.7	8	16°	50	4	7,870
CZS 4028-0800	2.8	8	16°	50	4	7,870
CZS 4029-0800	2.9	8	16°	50	4	7,870
CZS 4030-0450	3	4.5	16°	60	6	7,500
CZS 4030-0800		8		60		
CZS 4031-0800	3.1	8	16°	60	6	9,400
CZS 4032-0800	3.2	8	16°	60	6	9,400
CZS 4033-0800	3.3	8	16°	60	6	9,400
CZS 4034-0800	3.4	8	16°	60	6	9,400
CZS 4035-1000	3.5	10	16°	60	6	8,700
CZS 4036-1000	3.6	10	16°	60	6	9,400
CZS 4037-1000	3.7	10	16°	60	6	9,400
CZS 4038-1000	3.8	10	16°	60	6	9,400

4 Flutes

ø3mm Shank
V SeriesUDC-PCD
SeriesCBN
Series

Square

Square

Long Neck
Square

Radius

Radius

Long Neck
RadiusTaper Neck
RadiusBall / Long
Shank Ball

Ball

Long Neck
BallTaper Neck
Ball

Taper

Taper

Barrel

Spiral
V Cutter

Drill

Technical Data

Next Page →

Unit (mm)

Model Number	Outside Diameter ϕD	Length of Cut ℓ	Shank Taper Angle Bta	Overall Length L	Shank Diameter ϕd	Suggested Retail Price ¥
CZS 4039-1000	3.9	10	16°	60	6	9,400
CZS 4040-0600	4	6	16°	60	6	7,800
CZS 4040-1100		11		60	6	7,800
CZS 4041-1100	4.1	11	16°	60	6	9,750
CZS 4042-1100	4.2	11	16°	60	6	9,750
CZS 4043-1100	4.3	11	16°	60	6	9,750
CZS 4044-1100	4.4	11	16°	60	6	9,750
CZS 4045-1100	4.5	11	16°	60	6	9,300
CZS 4046-1100	4.6	11	16°	60	6	9,750
CZS 4047-1100	4.7	11	16°	60	6	9,750
CZS 4048-1100	4.8	11	16°	60	6	9,750
CZS 4049-1100	4.9	11	16°	60	6	9,750
CZS 4050-0750	5	7.5	16°	60	6	8,400
CZS 4050-1300		13		60	6	8,400
CZS 4051-1300	5.1	13	16°	60	6	10,500
CZS 4052-1300	5.2	13	16°	60	6	10,500
CZS 4053-1300	5.3	13	16°	60	6	10,500
CZS 4054-1300	5.4	13	16°	60	6	10,500
CZS 4055-1300	5.5	13	16°	60	6	9,600
CZS 4056-1300	5.6	13	16°	60	6	10,500
CZS 4057-1300	5.7	13	16°	60	6	10,500
CZS 4058-1300	5.8	13	16°	60	6	10,500
CZS 4059-1300	5.9	13	16°	60	6	10,500
CZS 4060-0900	6	9	—	60	6	8,700
CZS 4060-1300		13		60	6	8,700
CZS 4060-1800		18		60	6	9,600
CZS 4065-1600	6.5	16	16°	70	8	12,600
CZS 4070-1050	7	10.5	16°	70	8	11,300
CZS 4070-1600		16		70	8	11,300
CZS 4070-2100		21		70	8	12,500
CZS 4075-1600	7.5	16	16°	70	8	12,600
CZS 4080-1200	8	12	—	70	8	11,300
CZS 4080-1900		19		70	8	11,300
CZS 4080-2400		24		70	8	12,500

Next Page ➡

- φ3mm Shank V Series
- UDC-PCD Series
- CBN Series
- Square
- Long Neck Square
- Radius
- Long Neck Radius
- Taper Neck Radius
- Ball / Long Shank Ball
- Long Neck Ball
- Taper Neck Ball
- Taper
- Barrel
- Spiral V Cutter
- Drill
- Technical Data

Unit (mm)

Model Number	Outside Diameter ϕD	Length of Cut ℓ	Shank Taper Angle Bta	Overall Length L	Shank Diameter ϕd	Suggested Retail Price ¥
CZS 4085-1900	8.5	19	16°	80	10	14,600
CZS 4090-1350	9	13.5	16°	80	10	13,200
CZS 4090-1900		19		80	10	13,200
CZS 4090-2700		27		80	10	16,700
CZS 4095-1900		19		80	10	14,600
CZS 4100-1500	10	15	—	80	10	13,200
CZS 4100-2200		22		80	10	13,200
CZS 4100-3000		30		80	10	14,600
CZS 4105-2200	10.5	22	16°	100	12	21,000
CZS 4110-1650	11	16.5	16°	100	12	19,300
CZS 4110-2200		22		100	12	19,300
CZS 4110-3300		33		100	12	23,000
CZS 4115-2200	11.5	22	16°	100	12	21,000
CZS 4120-1800	12	18	—	100	12	19,300
CZS 4120-2600		26		100	12	19,300
CZS 4120-3600		36		100	12	21,300
CZS 4130-2600	13	26	—	110	12	26,500
CZS 4160-2400	16	24	—	110	16	54,200
CZS 4160-3200		32		110	16	57,000
CZS 4200-3000	20	30	—	125	20	79,800
CZS 4200-4000		40		125	20	84,000

4 Flutes

$\phi 3$ mm Shank
V Series

UDC-PCD
Series

CBN
Series

Square

Square

Long Neck
Square

Radius

Radius

Long Neck
Radius

Taper Neck
Radius

Ball

Ball / Long
Shank Ball

Long Neck
Ball

Taper Neck
Ball

Taper

Taper

Barrel

Barrel

Spiral
V Cutter

Spiral
V Cutter

Drill

Drill

Technical Data

Technical Data

CZS Series
S50C
Milling Video



Milling Conditions for CZS

◆1.5D flute length type

WORK MATERIAL			CARBON STEELS S45C / S50C Annealed Materials (~225HB)							
Model Number	Outside Diameter (mm)	Length of Cut (mm)	Spindle Speed (min ⁻¹)	Vertical		Slotting		Side Milling		
				Feed Rate (mm/min)	a _p Axial Depth (mm)	Feed Rate (mm/min)	a _p Axial Depth (mm)	Feed Rate (mm/min)	a _p Axial Depth (mm)	a _e Radial Depth (mm)
4010-0150	1	1.5	18,000	150	1	200	1	1,200	1.5	0.1※
4015-0225	1.5	2.25	16,000	200	1.5	550	1.5	1,800	2.25	0.15※
4020-0300	2	3	12,000	200	2	550	2	1,800	3	0.2※
4025-0375	2.5	3.75	10,000	300	2.5	950	2.5	2,400	3.75	0.25※
4030-0450	3	4.5	8,500	300	3	950	3	2,400	4.5	0.3※
4040-0600	4	6	7,200	300	4	950	4	1,350	6	0.8
4050-0750	5	7.5	6,000	300	5	1,000	5	1,500	7.5	1
4060-0900	6	9	5,000	300	6	1,000	6	1,600	9	1.2
4070-1050	7	10.5	4,200	300	7	1,000	7	1,500	10.5	1.4
4080-1200	8	12	3,500	300	8	950	8	1,400	12	1.6
4090-1350	9	13.5	2,900	300	9	950	9	1,300	13.5	1.8
4100-1500	10	15	2,300	300	10	900	10	1,200	15	2
4110-1650	11	16.5	2,050	280	11	900	11	1,150	16.5	2.2
4120-1800	12	18	1,850	260	12	850	12	1,100	18	2.4
4160-2400	16	24	1,380	150	Step Amount: 1.6 Max depth 10※	830	8※	550	24	3.2
4200-3000	20	30	1,000	150	Step Amount: 2 Max depth 10※	830	10※	500	30	4
Milling Amount (mm)				※ Depth: 1D Depth: 0.1D (Max 10 mm)		※ a _p : 1D a _p : 0.5D		a _p : Length of Cut a _e : 0.2D ※ a _e : 0.1D		

WORK MATERIAL			ALLOY STEELS SK / SCM Annealed Materials (225~325HB)							
Model Number	Outside Diameter (mm)	Length of Cut (mm)	Spindle Speed (min ⁻¹)	Vertical		Slotting		Side Milling		
				Feed Rate (mm/min)	a _p Axial Depth (mm)	Feed Rate (mm/min)	a _p Axial Depth (mm)	Feed Rate (mm/min)	a _p Axial Depth (mm)	a _e Radial Depth (mm)
4010-0150	1	1.5	14,500	50	1	150	1	900	1.5	0.1※
4015-0225	1.5	2.25	13,000	80	1.5	400	1.5	1,200	2.25	0.15※
4020-0300	2	3	10,000	80	2	400	2	1,200	3	0.2※
4025-0375	2.5	3.75	8,000	100	2.5	650	2.5	1,800	3.75	0.25※
4030-0450	3	4.5	6,800	100	3	650	3	1,800	4.5	0.3※
4040-0600	4	6	5,700	110	4	650	4	1,000	6	0.8
4050-0750	5	7.5	4,800	110	5	700	5	1,100	7.5	1
4060-0900	6	9	4,000	120	6	700	6	1,200	9	1.2
4070-1050	7	10.5	3,400	110	6※1	700	7	1,150	10.5	1.4
4080-1200	8	12	2,700	110	6※1	700	8	1,050	12	1.6
4090-1350	9	13.5	2,300	100	6※1	700	9	1,000	13.5	1.8
4100-1500	10	15	1,900	100	6※1	650	10	900	15	2
4110-1650	11	16.5	1,700	90	6※1	650	11	850	16.5	2.2
4120-1800	12	18	1,550	80	6※1	600	12	800	18	2.4
4160-2400	16	24	1,100	150	Step Amount: 1.6 Max 10 depth※2	400	8※	440	24	3.2
4200-3000	20	30	880	150	Step Amount: 2 Max 10 depth※2	400	10※	440	30	4
Milling Amount (mm)				※1 Depth: 1D Max 6 mm ※2 0.1D depth (Max 10 mm)		※ a _p : 1D a _p : 0.5D		a _p : Length of Cut a _e : 0.2D ※ a _e : 0.1D		

Milling Conditions for CZS

4 Flutes

WORK MATERIAL			STRUCTURAL STEELS SS400 Recommend water soluble or oil coolant. (Use cutting oils for vertical milling.)							
Model Number	Outside Diameter (mm)	Length of Cut (mm)	Spindle Speed (min ⁻¹)	Vertical		Slotting		Side Milling		
				Feed Rate (mm/min)	a_p Axial Depth (mm)	Feed Rate (mm/min)	a_p Axial Depth (mm)	Feed Rate (mm/min)	a_p Axial Depth (mm)	a_e Radial Depth (mm)
4010-0150	1	1.5	18,000	100	0.25※1	400	0.25※1	1,200	1.5	0.1※
4015-0225	1.5	2.25	16,000	100	0.375※1	600	0.375※1	1,800	2.25	0.15※
4020-0300	2	3	12,000	200	0.5※1	600	0.5※1	1,800	3	0.2※
4025-0375	2.5	3.75	10,000	300	1.25	950	2.5	2,400	3.75	0.25※
4030-0450	3	4.5	8,500	300	1.5	950	3	2,400	4.5	0.3※
4040-0600	4	6	7,200	300	2	950	4	1,350	6	0.8
4050-0750	5	7.5	6,000	300	2.5	1,000	5	1,500	7.5	1
4060-0900	6	9	5,000	300	3	1,000	6	1,600	9	1.2
4070-1050	7	10.5	4,200	300	3.5	900	7	1,500	10.5	1.4
4080-1200	8	12	3,500	250	4	850	8	1,400	12	1.6
4090-1350	9	13.5	2,900	250	4.5	800	9	1,300	13.5	1.8
4100-1500	10	15	2,300	200	5	750	10	1,200	15	2
4110-1650	11	16.5	2,050	200	5.5	750	11	1,150	16.5	2.2
4120-1800	12	18	1,850	180	6	700	12	1,100	18	2.4
4160-2400	16	24	1,380	150	Step Amount: 1.6 Max 10 depth※2	830	8※2	550	24	3.2
4200-3000	20	30	1,000	150	Step Amount: 2 Max 10 depth※2	830	10※2	500	30	4
Milling Amount (mm)				※1 Depth: 0.5D Depth: 0.25D ※2 Depth: 0.1D (Max 10 mm)		※1 a_p : 1D ※1 a_p : 0.25D ※2 a_p : 0.5D		※ a_p : Length of Cut a_e : 0.2D ※ a_e : 0.1D		

WORK MATERIAL			STAINLESS STEELS SUS304 Use water soluble or oil coolant.							
Model Number	Outside Diameter (mm)	Length of Cut (mm)	Spindle Speed (min ⁻¹)	Vertical		Slotting		Side Milling		
				Feed Rate (mm/min)	a_p Axial Depth (mm)	Feed Rate (mm/min)	a_p Axial Depth (mm)	Feed Rate (mm/min)	a_p Axial Depth (mm)	a_e Radial Depth (mm)
4010-0150	1	1.5	14,500	150	0.25	250	1	1,000	1.5	0.05※
4015-0225	1.5	2.25	13,000	150	0.375	270	1.5	1,500	2.25	0.075※
4020-0300	2	3	10,000	100	0.5	270	2	1,500	3	0.1※
4025-0375	2.5	3.75	8,000	100	0.625	300	2.5	2,000	3.75	0.125※
4030-0450	3	4.5	6,800	80	0.75	300	3	2,000	4.5	0.15※
4040-0600	4	6	5,700	90	1	350	4	1,150	6	0.4
4050-0750	5	7.5	4,800	100	1.25	400	5	1,300	7.5	0.5
4060-0900	6	9	4,000	100	1.5	400	6	1,300	9	0.6
4070-1050	7	10.5	3,200	100	1.75	350	7	1,300	10.5	0.7
4080-1200	8	12	2,400	90	2※	300	8	1,200	12	0.8
4090-1350	9	13.5	1,800	90	2※	250	9	1,100	13.5	0.9
4100-1500	10	15	1,400	80	2※	200	10	1,000	15	1
4110-1650	11	16.5	1,250	80	2※	200	11	900	16.5	1.1
4120-1800	12	18	1,250	70	2※	180	12	900	18	1.2
4160-2400	16	24	1,250	70	2※	450	6.4※	440	24	1.6
4200-3000	20	30	1,000	70	2※	450	8※	440	30	2
Milling Amount (mm)				※ Depth: 0.25D ※ Max 2 mm depth		※ a_p : 1D ※ a_p : 0.4D		※ a_p : Length of Cut a_e : 0.1D ※ a_e : 0.05D		

- 3mm Shank V Series
- UDC-PCD Series
- CBN Series
- Square
- Long Neck Square
- Radius
- Long Neck Radius
- Taper Neck Radius
- Ball / Long Shank Ball
- Long Neck Ball
- Taper Neck Ball
- Taper
- Barrel
- Spiral V Cutter
- Drill
- Technical Data

Milling Conditions for CZS

WORK MATERIAL			PREHARDENED STEELS HPM / NAK (30~45HRC)							
Model Number	Outside Diameter (mm)	Length of Cut (mm)	Spindle Speed (min ⁻¹)	Vertical		Slotting		Side Milling		
				Feed Rate (mm/min)	a _p Axial Depth (mm)	Feed Rate (mm/min)	a _p Axial Depth (mm)	Feed Rate (mm/min)	a _p Axial Depth (mm)	a _e Radial Depth (mm)
4010-0150	1	1.5	14,500	100	0.5	120	1	600	1.5	0.05※
4015-0225	1.5	2.25	12,000	150	0.75	320	1.5	900	2.25	0.075※
4020-0300	2	3	9,000	150	1	320	2	900	3	0.1※
4025-0375	2.5	3.75	7,500	200	1.25	520	2.5	1,200	3.75	0.125※
4030-0450	3	4.5	6,800	200	1.5	520	3	1,200	4.5	0.15※
4040-0600	4	6	5,100	220	2	520	4	700	6	0.4
4050-0750	5	7.5	4,050	240	2.5	520	5	850	7.5	0.5
4060-0900	6	9	3,300	240	3	520	6	1,000	9	0.6
4070-1050	7	10.5	2,900	240	3※	500	6※1	1,000	10.5	0.7
4080-1200	8	12	2,300	220	3※	470	6※1	900	12	0.8
4090-1350	9	13.5	1,900	220	3※	470	6※1	900	13.5	0.9
4100-1500	10	15	1,500	200	3※	450	6※1	900	15	1
4110-1650	11	16.5	1,350	200	3※	450	6※1	850	16.5	1.1
4120-1800	12	18	1,200	180	3※	420	6※1	800	18	1.2
4160-2400	16	24	1,110	150	3※	400	4~8※2	440	24	0.8※
4200-3000	20	30	880	150	3※	400	5~10※2	440	30	1※
Milling Amount (mm)				※ Depth: 0.5D Max 3 mm depth		a _p : 1D ※1 a _p : Max 6 mm ※2 a _p : 0.25~0.5D		a _p : Length of Cut a _e : 0.1D ※ a _e : 0.05D		

WORK MATERIAL			HARDENED STEELS SKD / SKT / STAVAX (45~55HRC)							
Model Number	Outside Diameter (mm)	Length of Cut (mm)	Spindle Speed (min ⁻¹)	Vertical		Slotting		Side Milling		
				Feed Rate (mm/min)	a _p Axial Depth (mm)	Feed Rate (mm/min)	a _p Axial Depth (mm)	Feed Rate (mm/min)	a _p Axial Depth (mm)	a _e Radial Depth (mm)
4010-0150	1	1.5	12,900	80	0.25	50	0.25※1	300	1.5	0.05※
4015-0225	1.5	2.25	10,000	150	0.375	100	0.375※1	650	2.25	0.075※
4020-0300	2	3	8,200	150	0.5	150	0.5※1	650	3	0.1※
4025-0375	2.5	3.75	7,000	250	0.625	300	2.5	1,000	3.75	0.125※
4030-0450	3	4.5	6,120	250	0.75	300	3	1,000	4.5	0.15※
4040-0600	4	6	5,000	220	1	320	4	600	6	0.4
4050-0750	5	7.5	4,300	180	1.25	340	5	800	7.5	0.5
4060-0900	6	9	3,600	160	1.5	360	6	1,000	9	0.6
4070-1050	7	10.5	2,800	160	1.5※	320	7	1,000	10.5	0.7
4080-1200	8	12	2,100	150	1.5※	280	8	1,000	12	0.8
4090-1350	9	13.5	1,600	130	1.5※	240	9	950	13.5	0.9
4100-1500	10	15	1,250	120	1.5※	200	10	750	15	1
4110-1650	11	16.5	1,150	110	1.5※	190	11	720	16.5	1.1
4120-1800	12	18	1,050	110	1.5※	180	12	700	18	1.2
4160-2400	16	24	800	50	1.5※	300	1.6※2	320	24	0.8※
4200-3000	20	30	630	50	1.5※	300	2※2	320	30	1※
Milling Amount (mm)				※ Depth: 0.25D Max 1.5 mm		a _p : 1D ※1 a _p : 0.25D ※2 a _p : 0.1D		a _p : Length of Cut a _e : 0.1D ※ a _e : 0.05D		

- φ3mm Shank V Series
- UDC-PCD Series
- CBN Series
- Square
- Long Neck Square
- Radius
- Long Neck Radius
- Taper Neck Radius
- Ball / Long Shank Ball
- Long Neck Ball
- Taper Neck Ball
- Taper
- Barrel
- Spiral V Cutter
- Drill
- Technical Data

Milling Conditions for CZS

◆ Standard flute length type

WORK MATERIAL			CARBON STEELS S45C / S50C Annealed Materials (~225HB)							
Model Number	Outside Diameter (mm)	Length of Cut (mm)	Spindle Speed (min ⁻¹)	Vertical		Slotting		Side Milling		
				Feed Rate (mm/min)	a_p Axial Depth (mm)	Feed Rate (mm/min)	a_p Axial Depth (mm)	Feed Rate (mm/min)	a_p Axial Depth (mm)	a_e Radial Depth (mm)
4010-0250	1	2.5	18,000	100	1	200	0.5※	1,200	1.5	0.1※
4020-0600	2	6	12,000	150	2	400	1※	1,800	3	0.2※
4030-0800	3	8	8,500	250	3	600	3	2,400	4.5	0.3※
4040-1100	4	11	7,200	270	4	650	4	1,350	6	0.8
4050-1300	5	13	6,000	300	5	700	5	1,500	7.5	1
4060-1300	6	13	5,000	300	6	700	6	1,600	9	1.2
4070-1600	7	16	4,200	300	7	700	7	1,500	10.5	1.4
4080-1900	8	19	3,500	300	8	700	8	1,400	12	1.6
4090-1900	9	19	2,900	300	9	700	9	1,300	13.5	1.8
4100-2200	10	22	2,300	300	10	700	10	1,200	15	2
4110-2200	11	22	2,050	280	11	670	11	1,150	16.5	2.2
4120-2600	12	26	1,850	260	12	650	12	1,100	18	2.4
4130-2600	13	26	1,400	80	13	300	13	700	19.5	1.3※
4160-3200	16	32	1,380	150	Step Amount: 1.6 Max 10 depth※	830	8※	550	24	3.2
4200-4000	20	40	1,000	150	Step Amount: 2 Max 10 depth※	830	10※	500	30	4
Milling Amount (mm)				※ Depth: 1D Depth: 0.1D (Max 10 mm)		※ a_p :1D ※ a_p :0.5D		※ a_p :1.5D ※ a_e :0.2D ※ a_e :0.1D		

WORK MATERIAL			ALLOY STEELS SK / SCM Annealed Materials (225~325HB)							
Model Number	Outside Diameter (mm)	Length of Cut (mm)	Spindle Speed (min ⁻¹)	Vertical		Slotting		Side Milling		
				Feed Rate (mm/min)	a_p Axial Depth (mm)	Feed Rate (mm/min)	a_p Axial Depth (mm)	Feed Rate (mm/min)	a_p Axial Depth (mm)	a_e Radial Depth (mm)
4010-0250	1	2.5	14,500	50	1	150	0.5※	900	1.5	0.1※
4020-0600	2	6	10,000	80	2	300	1※	1,200	3	0.2※
4030-0800	3	8	6,800	100	3	400	3	1,800	4.5	0.3※
4040-1100	4	11	5,700	110	4	450	4	1,000	6	0.8
4050-1300	5	13	4,800	110	5	500	5	1,100	7.5	1
4060-1300	6	13	4,000	120	6	500	6	1,200	9	1.2
4070-1600	7	16	3,400	110	6※1	500	7	1,150	10.5	1.4
4080-1900	8	19	2,700	110	6※1	500	8	1,050	12	1.6
4090-1900	9	19	2,300	100	6※1	500	9	1,000	13.5	1.8
4100-2200	10	22	1,900	100	6※1	500	10	900	15	2
4110-2200	11	22	1,700	90	6※1	450	11	850	16.5	2.2
4120-2600	12	26	1,550	80	6※1	450	12	800	18	2.4
4130-2600	13	26	1,100	25	6※1	180	13	550	19.5	1.3※
4160-3200	16	32	1,100	150	Step Amount: 1.6 Max 10 depth※2	300	8※	440	24	3.2
4200-4000	20	40	880	150	Step Amount: 2 Max 10 depth※2	300	10※	440	30	4
Milling Amount (mm)				※1 Depth: 1D Max 6 mm ※2 Depth: 0.1D (Max 10 mm)		※ a_p :1D ※ a_p :0.5D		※ a_p :1.5D ※ a_e :0.2D ※ a_e :0.1D		

4 Flutes

Ø3mm Shank
V Series

UDC-PCD
Series

CBN
Series

Square

Long Neck
Square

Radius

Long Neck
Radius

Taper Neck
Radius

Ball / Long
Shank Ball

Long Neck
Ball

Taper Neck
Ball

Taper

Barrel

Spiral
V Cutter

Drill

Technical Data

Milling Conditions for CZS

WORK MATERIAL			STRUCTURAL STEELS SS400 Recommend water soluble or oil coolant. (Use cutting oils for vertical milling.)							
Model Number	Outside Diameter (mm)	Length of Cut (mm)	Spindle Speed (min ⁻¹)	Vertical		Slotting		Side Milling		
				Feed Rate (mm/min)	a _p Axial Depth (mm)	Feed Rate (mm/min)	a _p Axial Depth (mm)	Feed Rate (mm/min)	a _p Axial Depth (mm)	a _e Radial Depth (mm)
4010-0250	1	2.5	18,000	100	0.25※1	400	0.25※1	1,200	1.5	0.1※
4020-0600	2	6	12,000	200	0.5※1	600	0.5※1	1,800	3	0.2※
4030-0800	3	8	8,500	300	1.5	600	3	2,400	4.5	0.3※
4040-1100	4	11	7,200	300	2	650	4	1,350	6	0.8
4050-1300	5	13	6,000	300	2.5	700	5	1,500	7.5	1
4060-1300	6	13	5,000	300	3	700	6	1,600	9	1.2
4070-1600	7	16	4,200	270	3.5	700	7	1,500	10.5	1.4
4080-1900	8	19	3,500	250	4	700	8	1,400	12	1.6
4090-1900	9	19	2,900	220	4.5	700	9	1,300	13.5	1.8
4100-2200	10	22	2,300	200	5	700	10	1,200	15	2
4110-2200	11	22	2,050	190	5.5	680	11	1,150	16.5	2.2
4120-2600	12	26	1,850	180	6	650	12	1,100	18	2.4
4130-2600	13	26	1,100	55	6.5	180	13	550	19.5	1.3※
4160-3200	16	32	1,380	150	Step Amount: 1.6 Max 10 depth※2	830	8※2	550	24	3.2
4200-4000	20	40	1,000	150	Step Amount: 2 Max 10 depth※2	830	10※2	500	30	4
Milling Amount (mm)				※1 Depth: 0.5D ※2 Depth: 0.25D (Max 10 mm)	※1 a _p : 1D ※2 a _p : 0.5D	※ a _p : 1.5D ※ a _e : 0.2D ※ a _e : 0.1D				

WORK MATERIAL			STAINLESS STEELS SUS304 Use water soluble or oil coolant.							
Model Number	Outside Diameter (mm)	Length of Cut (mm)	Spindle Speed (min ⁻¹)	Vertical		Slotting		Side Milling		
				Feed Rate (mm/min)	a _p Axial Depth (mm)	Feed Rate (mm/min)	a _p Axial Depth (mm)	Feed Rate (mm/min)	a _p Axial Depth (mm)	a _e Radial Depth (mm)
4010-0250	1	2.5	14,500	150	0.25	250	0.5	1,000	1.5	0.05※
4020-0600	2	6	10,000	100	0.5	270	1	1,500	3	0.1※
4030-0800	3	8	6,800	80	0.75	300	1.5	2,000	4.5	0.15※
4040-1100	4	11	5,700	90	1	350	2	1,150	6	0.4
4050-1300	5	13	4,800	100	1.25	400	2.5	1,300	7.5	0.5
4060-1300	6	13	4,000	100	1.5	400	3	1,300	9	0.6
4070-1600	7	16	3,200	100	1.75	350	3.5	1,300	10.5	0.7
4080-1900	8	19	2,400	90	2※1	300	4	1,200	12	0.8
4090-1900	9	19	1,800	90	2※1	250	4.5	1,100	13.5	0.9
4100-2200	10	22	1,400	80	2※1	200	5	1,000	15	1
4110-2200	11	22	1,250	80	2※1	200	5.5	900	16.5	1.1
4120-2600	12	26	1,250	70	2※1	180	6	900	18	1.2
4130-2600	13	26	1,050	20	1.5※2	120	6.5	900	19.5	0.65※
4160-3200	16	32	1,250	70	2※1	450	1.6※	440	24	1.6
4200-4000	20	40	1,000	70	2※1	450	2※	440	30	2
Milling Amount (mm)				※1 Depth: 0.25D ※2 Max 2 mm depth Max 1.5 mm depth	※ a _p : 0.5D ※ a _p : 0.1D	※ a _p : 1.5D ※ a _e : 0.1D ※ a _e : 0.05D				

- φ3mm Shank V Series
- UDC-PCD Series
- CBN Series
- Square
- Long Neck Square
- Radius
- Long Neck Radius
- Taper Neck Radius
- Ball / Long Shank Ball
- Long Neck Ball
- Taper Neck Ball
- Taper
- Barrel
- Spiral V Cutter
- Drill
- Technical Data

Milling Conditions for CZS

4 Flutes

WORK MATERIAL			PREHARDENED STEELS HPM / NAK (30~45HRC)							
Model Number	Outside Diameter (mm)	Length of Cut (mm)	Spindle Speed (min ⁻¹)	Vertical		Slotting		Side Milling		
				Feed Rate (mm/min)	a _p Axial Depth (mm)	Feed Rate (mm/min)	a _p Axial Depth (mm)	Feed Rate (mm/min)	a _p Axial Depth (mm)	a _e Radial Depth (mm)
4010-0250	1	2.5	12,900	80	0.5	140	1	270	1.5	0.2
4020-0600	2	6	9,350	110	1	230	2	400	3	0.4
4030-0800	3	8	6,120	120	1.5	270	3	450	4.5	0.6
4040-1100	4	11	5,250	130	2	320	4	500	6	0.8
4050-1300	5	13	4,460	150	2.5	360	5	540	7.5	1
4060-1300	6	13	3,600	160	3	360	6	540	9	1.2
4070-1600	7	16	2,850	140	2**	340	7	540	10.5	1.4
4080-1900	8	19	2,320	90	2**	320	8	480	12	1.6
4090-1900	9	19	1,700	80	2**	250	9	410	13.5	1.8
4100-2200	10	22	1,250	60	2**	180	10	340	15	2
4110-2200	11	22	1,100	55	2**	170	11	320	16.5	2.2
4120-2600	12	26	1,050	50	2**	160	12	320	18	2.4
4130-2600	13	26	1,000	N/A	N/A	100	6.5**	300	19.5	1.3**
4160-3200	16	32	960	40	2**	350	8**	380	24	1.6**
4200-4000	20	40	770	40	2**	350	10**	380	30	2**
Milling Amount (mm)				Depth: 0.5D ** Max 2 mm depth		a _p :1D ** a _p :0.5D		a _p :1.5D a _e :0.2D ** a _e :0.1D		

WORK MATERIAL			HARDENED STEELS SKD / SKT / STAVAX (45~55HRC)							
Model Number	Outside Diameter (mm)	Length of Cut (mm)	Spindle Speed (min ⁻¹)	Vertical		Slotting		Side Milling		
				Feed Rate (mm/min)	a _p Axial Depth (mm)	Feed Rate (mm/min)	a _p Axial Depth (mm)	Feed Rate (mm/min)	a _p Axial Depth (mm)	a _e Radial Depth (mm)
4010-0250	1	2.5	12,900	80	0.25	50	0.25**1	300	1.5	0.05**
4020-0600	2	6	8,200	150	0.5	150	0.5**1	650	3	0.1**
4030-0800	3	8	6,120	250	0.75	300	1.5	1,000	4.5	0.15**
4040-1100	4	11	5,000	220	1	320	2	500	6	0.4
4050-1300	5	13	4,300	180	1.25	340	2.5	520	7.5	0.5
4060-1300	6	13	3,600	160	1.5	360	3	540	9	0.6
4070-1600	7	16	2,800	160	1.5**1	320	3.5	520	10.5	0.7
4080-1900	8	19	2,100	150	1.5**1	280	4	500	12	0.8
4090-1900	9	19	1,600	130	1.5**1	240	4.5	470	13.5	0.9
4100-2200	10	22	1,250	120	1.5**1	200	5	450	15	1
4110-2200	11	22	1,150	110	1.5**1	190	5.5	440	16.5	1.1
4120-2600	12	26	1,050	110	1.5**1	180	6	420	18	1.2
4130-2600	13	26	900	N/A	N/A	N/A	N/A	370	19.5	0.65**
4160-3200	16	32	800	50	Step Amount: 1.6 Max 10 depth**2	300	1.6**2	320	24	0.8**
4200-4000	20	40	630	50	Step Amount: 2 Max 10 depth**2	300	2**2	320	30	1**
Milling Amount (mm)				Depth: 0.25D **1 Max 1.5 mm **2 Depth: 0.1D (Max 10 mm)		a _p :0.5D **1 a _p :0.25D **2 a _p :0.1D		a _p :1.5D a _e :0.1D ** a _e :0.05D		

- Ø3mm Shank V Series
- UDC-PCD Series
- CBN Series
- Square
 - Long Neck Square
- Radius
 - Long Neck Radius
 - Taper Neck Radius
- Ball / Long Shank Ball
 - Long Neck Ball
 - Taper Neck Ball
- Taper
 - Taper
- Barrel
- Spiral V Cutter
- Drill
- Technical Data

Milling Conditions for CZS

◆3D flute length type

WORK MATERIAL			CARBON STEELS S45C / S50C Annealed Materials (~225HB)							
Model Number	Outside Diameter (mm)	Length of Cut (mm)	Spindle Speed (min ⁻¹)	Vertical		Slotting		Side Milling		
				Feed Rate (mm/min)	a_p Axial Depth (mm)	Feed Rate (mm/min)	a_p Axial Depth (mm)	Feed Rate (mm/min)	a_p Axial Depth (mm)	a_e Radial Depth (mm)
4060-1800	6	18	5,000	200	6	500	6	1,600	18	0.6
4070-2100	7	21	4,100	200	7	450	7	1,450	21	0.7
4080-2400	8	24	3,200	150	8	400	8	1,300	24	0.8
4090-2700	9	27	2,400	140	9	350	9	1,150	27	0.9
4100-3000	10	30	1,850	120	10	320	10	1,000	30	1
4110-3300	11	33	1,650	100	11	300	11	900	33	1.1
4120-3600	12	36	1,500	90	12	300	12	800	36	1.2
Milling Amount (mm)				Depth: 1D		a_p : 1D		a_p : Length of Cut a_e : 0.1D		

WORK MATERIAL			ALLOY STEELS SK / SCM Annealed Materials (225~325HB)							
Model Number	Outside Diameter (mm)	Length of Cut (mm)	Spindle Speed (min ⁻¹)	Vertical		Slotting		Side Milling		
				Feed Rate (mm/min)	a_p Axial Depth (mm)	Feed Rate (mm/min)	a_p Axial Depth (mm)	Feed Rate (mm/min)	a_p Axial Depth (mm)	a_e Radial Depth (mm)
4060-1800	6	18	4,000	60	6	350	6	1,200	18	0.6
4070-2100	7	21	3,400	60	6	330	7	1,150	21	0.7
4080-2400	8	24	2,700	50	6	300	8	1,050	24	0.8
4090-2700	9	27	2,050	50	6	270	9	1,000	27	0.9
4100-3000	10	30	1,500	40	6	240	10	900	30	1
4110-3300	11	33	1,350	40	6	220	11	850	33	1.1
4120-3600	12	36	1,200	30	6	200	12	750	36	1.2
Milling Amount (mm)				Max 6 mm depth		a_p : 1D		a_p : Length of Cut a_e : 0.1D		

WORK MATERIAL			STRUCTURAL STEELS SS400 Recommend water soluble or oil coolant. (Use cutting oils for vertical milling.)							
Model Number	Outside Diameter (mm)	Length of Cut (mm)	Spindle Speed (min ⁻¹)	Vertical		Slotting		Side Milling		
				Feed Rate (mm/min)	a_p Axial Depth (mm)	Feed Rate (mm/min)	a_p Axial Depth (mm)	Feed Rate (mm/min)	a_p Axial Depth (mm)	a_e Radial Depth (mm)
4060-1800	6	18	4,000	120	3	300	6	1,300	18	0.6
4070-2100	7	21	3,400	110	3.5	280	7	1,200	21	0.7
4080-2400	8	24	2,700	90	4	250	8	1,150	24	0.8
4090-2700	9	27	2,100	80	4.5	230	9	1,050	27	0.9
4100-3000	10	30	1,500	70	5	200	10	1,000	30	1
4110-3300	11	33	1,350	65	5.5	190	11	950	33	1.1
4120-3600	12	36	1,200	60	6	190	12	900	36	1.2
Milling Amount (mm)				Depth: 0.5D		a_p : 1D		a_p : Length of Cut a_e : 0.1D		

Milling Conditions for CZS

4 Flutes

WORK MATERIAL			STAINLESS STEELS SUS304 Use water soluble or oil coolant.							
Model Number	Outside Diameter (mm)	Length of Cut (mm)	Spindle Speed (min ⁻¹)	Vertical		Slotting		Side Milling		
				Feed Rate (mm/min)	a_p Axial Depth (mm)	Feed Rate (mm/min)	a_p Axial Depth (mm)	Feed Rate (mm/min)	a_p Axial Depth (mm)	a_e Radial Depth (mm)
4060-1800	6	18	2,800	40	1.5	200	3	900	18	0.3
4070-2100	7	21	2,450	40	1.5	190	3.5	950	21	0.35
4080-2400	8	24	2,100	40	1.5	180	4	950	24	0.4
4090-2700	9	27	1,700	30	1.5	170	4.5	1,000	27	0.45
4100-3000	10	30	1,400	30	1.5	150	5	1,000	30	0.5
4110-3300	11	33	1,250	30	1.5	140	5.5	1,000	33	0.55
4120-3600	12	36	1,150	25	1.5	130	6	950	36	0.6
Milling Amount (mm)				Max 1.5 mm depth		a_p : 0.5D		a_p : Length of Cut a_e : 0.05D		

WORK MATERIAL			PREHARDENED STEELS HPM / NAK (30~45HRC)							
Model Number	Outside Diameter (mm)	Length of Cut (mm)	Spindle Speed (min ⁻¹)	Vertical		Slotting		Side Milling		
				Feed Rate (mm/min)	a_p Axial Depth (mm)	Feed Rate (mm/min)	a_p Axial Depth (mm)	Feed Rate (mm/min)	a_p Axial Depth (mm)	a_e Radial Depth (mm)
4060-1800	6	18	3,000	—	—	160	6	600	18	0.3
4070-2100	7	21	2,500	—	—	160	6	700	21	0.35
4080-2400	8	24	2,150	—	—	150	6	750	24	0.4
4090-2700	9	27	1,850	—	—	150	6	800	27	0.45
4100-3000	10	30	1,500	—	—	140	6	900	30	0.5
4110-3300	11	33	1,350	—	—	130	6	850	33	0.55
4120-3600	12	36	1,200	—	—	120	6	800	36	0.6
Milling Amount (mm)				N/A		a_p : Max 6 mm		a_p : Length of Cut a_e : 0.05D		

WORK MATERIAL			HARDENED STEELS SKD / SKT / STAVAX (45~55HRC)							
Model Number	Outside Diameter (mm)	Length of Cut (mm)	Spindle Speed (min ⁻¹)	Vertical		Slotting		Side Milling		
				Feed Rate (mm/min)	a_p Axial Depth (mm)	Feed Rate (mm/min)	a_p Axial Depth (mm)	Feed Rate (mm/min)	a_p Axial Depth (mm)	a_e Radial Depth (mm)
4060-1800	6	18	3,600	—	—	—	—	540	18	0.3
4070-2100	7	21	2,900	—	—	—	—	520	21	0.35
4080-2400	8	24	2,300	—	—	—	—	500	24	0.4
4090-2700	9	27	1,700	—	—	—	—	470	27	0.45
4100-3000	10	30	1,250	—	—	—	—	450	30	0.5
4110-3300	11	33	1,100	—	—	—	—	420	33	0.55
4120-3600	12	36	1,000	—	—	—	—	400	36	0.6
Milling Amount (mm)				N/A		N/A		a_p : Length of Cut a_e : 0.05D		

Ø3mm Shank
V Series

UDC-PCD
Series

CBN
Series

Square

Long Neck
Square

Radius

Long Neck
Radius

Taper Neck
Radius

Ball / Long
Shank Ball

Long Neck
Ball

Taper Neck
Ball

Taper

Barrel

Spiral
V Cutter

Drill

Technical Data

Milling Conditions for CZS

Slotting

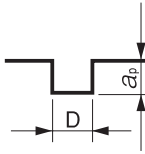

D : Outside Diameter (mm)

Side Milling

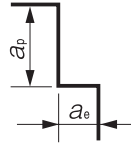

Note:

- Decrease both spindle speed and feed rate proportionally when the milling parameters exceed the machines maximum speed, or when the tool is chattering and heats up to a red color.
- These milling parameters are calculated based on the shortest overhang length. Longer overhangs may require an adjustment to the milling parameters.
- Reduce the milling amount and feed rate in accordance with required milling precision.
- Spindle rigidity should be considered when setting milling parameters, especially for Z-Axis drilling.
- When slotting, using Z-Axis drilling, the milling parameters should promote good chip evacuation.
- Reduce the milling amount when chips clog on the tool during Z-Axis drilling.
- The milling parameter of outside diameter 16 and 20 is calculated based on BT50 spindle type. Decrease 50% milling amount for BT40 spindle type.
- Recommend water soluble or oil coolant.
- Recommend water soluble coolant (through spindle type) for Stainless Steels and Aluminum Alloys.
- Recommend oil coolant for Titanium Alloys and Heat Resistant Alloys.

ø3mm Shank
V Series

UDC-PCD
Series

CBN
Series

Square

Square
Long Neck
Square

Radius

Radius
Long Neck
Radius

Taper Neck
Radius

Ball / Long
Shank Ball

Ball
Long Neck
Ball

Taper Neck
Ball

Taper

Taper

Barrel

Spiral
V Cutter

Drill

Technical Data

Pocket Milling Example
CZS $\phi 8 \times L12$

SCM420H



Pocket Size : 9 × 15 × Depth 4 mm

Spindle Speed	2,700 min ⁻¹
Z-Drilling Feed Rate	220 mm/min
X-Y Milling Feed Rate	500 mm/min
Number of holes	864 holes
Coolant	Water Soluble

Z-drilling Depth 1 mm × 4 times Dwell 0.1 sec

Drilling and Milling → 144 min

CZS → 72 min

**1/2
Cycle Time!**

After milling 864 holes (32 pieces)

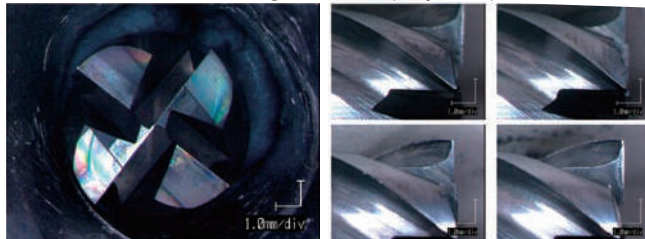

Less cycle time! More tool life left after milling 864 holes!

Comparison with Conventional Model
CZS $\phi 6.5 \times L16$

S45C

CZS

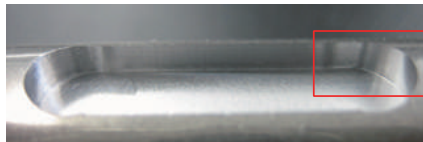
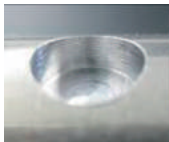

Conventional 4 Flute Square

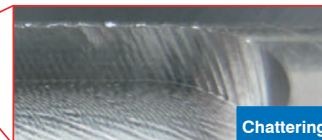
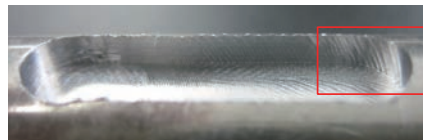

Cantilevered work piece

Spindle Speed	2,200 min ⁻¹
Z-Drilling Feed Rate	100 mm/min
Slotting Feed Rate	400 mm/min
a_p	3 mm
Overhang Length	25 mm
Coolant	Air Blow (Through Spindle)
Milled Size	Slitting 6.5 × 24.5 × 3 mm Spot Facing 6.5 × 3 mm

Variable Pitch Prevents Chattering!

4 Flutes

$\phi 3$ mm Shank
V Series

UDC-PCD
Series

CBN
Series

Square

Square

Long Neck
Square

Radius

Radius

Long Neck
Radius

Taper Neck
Radius

Ball / Long
Shank Ball

Ball

Long Neck
Ball

Taper Neck
Ball

Taper

Taper

Barrel

Spiral
V Cutter

Drill

Technical Data



Size $\phi 1 \sim \phi 16$

CXES



Material Applications (★ Highly Recommended ● Recommended ○ Suggested)

Work Material																	
Carbon Steels S45C S55C	Alloy Steels SK / SCM SUS	Prehardened Steels NAK HPM	Hardened Steels					Cast Iron	Aluminum Alloys	Graphite	Copper	Plastics	Glass Filled Plastics	Titanium Alloys	Heat Resistant Alloys	Cemented Carbide	Hard Brittle (Non-Metallic) Materials
			~50HRC	~55HRC	~60HRC	~65HRC	~70HRC										
●	●	●	●	○				○			●			○	○		

Features

Variable Division & Helix design minimizes vibration and chattering.
 Selected high toughness and chip resistant carbide material.
 Optimized flute design offers outstandingly high efficiency milling and fine finishing.
 Low friction coating resulting in excellent chip evacuation and resistance to wear.

The shank taper angle shown is not an exact value and to avoid contact with the work piece, we recommend the user controls the precise value of this angle. Shank taper angle should not make contact with the work piece. Actual measurement is necessary when using longer length of cut than the written length.

Shape A

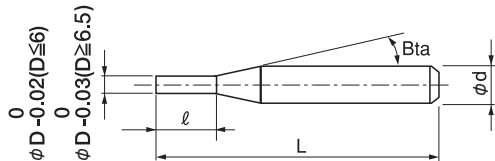

Shape B

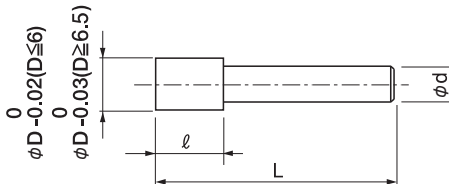

Total 55 models

Unit (mm)

Model Number	Outside Diameter ϕD	Length of Cut l	Shank Taper Angle Bta	Overall Length L	Shank Diameter ϕd	Shape	Suggested Retail Price ¥
CXES 4010-0250	1	2.5	16°	50	4	A	6,520
CXES 4010-0300		3		60	4		7,180
CXES 4010-0400		4		60	4		7,900
CXES 4010-0500		5		60	4		10,270
CXES 4015-0375	1.5	3.75	16°	50	4	A	6,520
CXES 4015-0600		6		50	4		7,900
CXES 4020-0500	2	5	16°	50	4	A	6,100
CXES 4020-0600		6		60	4		6,710
CXES 4020-0800		8		60	4		7,390
CXES 4020-1000		10		60	4		9,610
CXES 4025-0625		2.5		6.25	16°		50
CXES 4025-1000	10		50	4		7,390	

Unit (mm)

Model Number	Outside Diameter ϕD	Length of Cut ℓ	Shank Taper Angle Bta	Overall Length L	Shank Diameter ϕd	Shape	Suggested Retail Price ¥
CXES 4030-0750	3	7.5	16°	50	6	A	7,000
CXES 4030-0900		9		60	6		7,700
CXES 4030-1200		12		60	6		8,470
CXES 4030-1500		15		60	6		11,020
CXES 4035-0900	3.5	9	16°	60	6	A	8,270
CXES 4040-1000	4	10	16°	50	6	A	7,350
CXES 4040-1200		12		60	6		8,090
CXES 4040-1600		16		60	6		8,900
CXES 4040-2000		20		60	6		11,570
CXES 4045-1150	4.5	11.5	16°	60	6	A	8,840
CXES 4050-1250	5	12.5	16°	50	6	A	7,900
CXES 4050-1500		15		60	6		8,690
CXES 4050-2000		20		60	6		9,560
CXES 4050-2500		25		70	6		12,430
CXES 4055-1400	5.5	14	16°	60	6	A	9,120
CXES 4060-1500	6	15	—	50	6	A	8,500
CXES 4060-1800		18		60	6		9,350
CXES 4060-2400		24		70	6		10,760
CXES 4060-3000		30		80	6		13,990
CXES 4065-1650	6.5	16.5	16°	60	8	A	11,970
CXES 4070-1050	7	10.5	—	100	6	B	14,880
CXES 4070-1750		17.5	16°	70	8	A	10,500
CXES 4075-1900	7.5	19	16°	60	8	A	11,970
CXES 4080-2000	8	20	—	60	8	A	10,500
CXES 4080-2400		24		70	8		11,550
CXES 4080-3200		32		80	8		15,600
CXES 4080-4000		40		90	8		20,280
CXES 4085-2150	8.5	21.5	16°	70	10	A	13,870
CXES 4090-1350	9	13.5	—	140	8	B	19,390
CXES 4090-2250		22.5	16°	80	10	A	12,500
CXES 4095-2400	9.5	24	16°	70	10	A	13,870
CXES 4100-2500	10	25	—	70	10	A	12,500
CXES 4100-3000		30		80	10		13,750
CXES 4100-4000		40		90	10		18,570
CXES 4100-5000		50		100	10		24,150
CXES 4110-1650	11	16.5	—	150	10	B	24,200
CXES 4110-2750		27.5	16°	100	12	A	17,800
CXES 4120-3000	12	30	—	90	12	A	17,800
CXES 4120-3600		36		100	12		19,580
CXES 4120-4800		48		110	12		26,440
CXES 4120-6000		60		120	12		34,380
CXES 4130-1950	13	19.5	—	160	12	B	30,390
CXES 4160-4000	16	40	—	110	16	A	54,150

4 Flutes

 3mm Shank V Series

 UDC-PCD Series

 CBN Series

 Square

 Long Neck Square

 Radius

 Long Neck Radius

 Taper Neck Radius

 Ball / Long Shank Ball

 Long Neck Ball

 Taper Neck Ball

 Taper

 Barrel

 Spiral V Cutter

 Drill

 Technical Data

Milling Conditions for CXES

Side Milling

WORK MATERIAL			CARBON STEELS S45C / S50C Annealed Materials (~225HB)				ALLOY STEELS SK / SCM Annealed Materials (225~325HB)				STAINLESS STEELS SUS304 Use water soluble or oil coolant.			
Model Number	Outside Diameter (mm)	Length of Cut (mm)	Spindle Speed (min ⁻¹)	Feed Rate (mm/min)	a _p Axial Depth (mm)	a _e Radial Depth (mm)	Spindle Speed (min ⁻¹)	Feed Rate (mm/min)	a _p Axial Depth (mm)	a _e Radial Depth (mm)	Spindle Speed (min ⁻¹)	Feed Rate (mm/min)	a _p Axial Depth (mm)	a _e Radial Depth (mm)
4010-0250	1	2.5	18,000	620	2.5	0.2	18,000	460	2.5	0.2	14,500	320	2.5	0.1
4010-0300		3	18,000	620	3	0.03	18,000	460	3	0.03	14,300	310	3	0.015
4010-0400		4	18,000	620	4	0.02	18,000	460	4	0.02	13,900	290	4	0.01
4010-0500		5	18,000	620	5	0.02	18,000	460	5	0.02	13,900	290	5	0.01
4015-0375	1.5	3.75	13,500	770	3.75	0.3	13,500	570	3.75	0.3	13,300	340	3.75	0.15
4015-0600		6	13,500	770	6	0.03	13,500	570	6	0.03	12,700	310	6	0.015
4020-0500	2	5	11,000	930	5	0.4	11,000	690	5	0.4	12,200	360	5	0.2
4020-0600		6	11,000	930	6	0.06	11,000	690	6	0.06	12,000	340	6	0.03
4020-0800		8	11,000	930	8	0.04	11,000	690	8	0.04	11,600	300	8	0.02
4020-1000		10	11,000	930	10	0.04	11,000	690	10	0.04	11,600	300	10	0.02
4025-0625	2.5	6.25	9,500	1,060	6.25	0.5	9,500	800	6.25	0.5	11,000	490	6.25	0.25
4025-1000		10	9,500	1,060	10	0.05	9,500	800	10	0.05	10,400	430	10	0.025
4030-0750	3	7.5	8,500	1,200	7.5	0.6	8,500	900	7.5	0.6	10,000	640	7.5	0.3
4030-0900		9	8,500	1,200	9	0.3	8,500	900	9	0.3	9,100	580	9	0.15
4030-1200		12	8,500	1,200	12	0.06	8,500	900	12	0.06	7,300	460	12	0.03
4030-1500		15	8,500	1,200	15	0.06	8,500	900	15	0.06	7,300	460	15	0.03
4035-0900	3.5	9	7,800	1,250	9	0.7	7,500	950	9	0.7	8,600	680	9	0.35
4040-1000	4	10	7,200	1,350	10	0.8	6,700	1,000	10	0.8	7,500	730	10	0.4
4040-1200		12	7,200	1,350	12	0.4	6,700	1,000	12	0.4	6,600	640	12	0.2
4040-1600		16	7,200	1,350	16	0.08	6,700	1,000	16	0.08	4,800	460	16	0.08
4040-2000		20	7,200	1,350	20	0.08	6,700	1,000	20	0.08	4,800	460	20	0.08
4045-1150	4.5	11.5	6,550	1,400	11.5	0.9	6,000	1,050	11.5	0.9	6,300	770	11.5	0.45
4050-1250	5	12.5	6,000	1,500	12.5	1	5,400	1,100	12.5	1	5,400	810	12.5	0.5
4050-1500		15	6,000	1,500	15	0.5	5,400	1,100	15	0.5	4,600	690	15	0.25
4050-2000		20	6,000	1,500	20	0.1	5,400	1,100	20	0.1	3,700	450	20	0.1
4050-2500		25	6,000	1,500	25	0.1	5,400	1,100	25	0.1	3,700	450	25	0.1
4055-1400	5.5	14	5,450	1,550	14	1.1	4,900	1,150	14	1.1	4,900	810	14	0.55
4060-1500	6	15	5,000	1,600	15	1.2	4,500	1,200	15	1.2	4,500	810	15	0.6
4060-1800		18	5,000	1,600	18	0.6	4,500	1,200	18	0.6	3,700	660	18	0.3
4060-2400		24	5,000	1,400	24	0.12	4,500	1,050	24	0.12	2,900	360	24	0.12
4060-3000		30	5,000	1,400	30	0.12	4,500	1,050	30	0.12	2,900	360	30	0.12
4065-1650	6.5	16.5	4,400	1,500	16.5	1.3	3,950	1,150	16.5	1.3	3,950	780	16.5	0.65

Milling Conditions for CXES

4 Flutes

WORK MATERIAL			PREHARDENED STEELS HPM / NAK (30~45HRC)				HARDENED STEELS SKD / SKT / STAVAX (45~55HRC)			
Model Number	Outside Diameter (mm)	Length of Cut (mm)	Spindle Speed (min ⁻¹)	Feed Rate (mm/min)	a_p Axial Depth (mm)	a_e Radial Depth (mm)	Spindle Speed (min ⁻¹)	Feed Rate (mm/min)	a_p Axial Depth (mm)	a_e Radial Depth (mm)
4010-0250	1	2.5	12,900	320	2.5	0.2	12,900	180	2.5	0.05
4010-0300		3	12,800	320	3	0.03	12,900	180	3	0.015
4010-0400		4	12,600	320	4	0.02	12,900	180	4	0.01
4010-0500		5	12,600	320	5	0.01	12,900	180	5	0.005
4015-0375	1.5	3.75	10,500	390	3.75	0.3	9,300	280	3.75	0.075
4015-0600		6	10,200	390	6	0.03	9,300	280	6	0.015
4020-0500	2	5	9,350	450	5	0.4	7,600	390	5	0.1
4020-0600		6	9,250	450	6	0.06	7,600	390	6	0.03
4020-0800		8	9,050	450	8	0.04	7,600	390	8	0.02
4020-1000		10	9,050	450	10	0.01	7,600	390	10	0.01
4025-0625	2.5	6.25	8,300	540	6.25	0.5	6,500	510	6.25	0.125
4025-1000		10	8,000	540	10	0.05	6,500	510	10	0.025
4030-0750	3	7.5	7,400	630	7.5	0.6	5,900	500	7.5	0.3
4030-0900		9	7,050	630	9	0.3	5,900	500	9	0.15
4030-1200		12	6,350	630	12	0.06	5,900	500	12	0.03
4030-1500		15	6,350	630	15	0.03	5,900	500	15	0.015
4035-0900	3.5	9	6,500	640	9	0.7	5,200	510	9	0.35
4040-1000	4	10	5,900	650	10	0.8	4,700	520	10	0.4
4040-1200		12	5,500	650	12	0.4	4,700	520	12	0.2
4040-1600		16	4,700	580	16	0.08	4,700	520	16	0.04
4040-2000		20	4,700	580	20	0.04	4,700	520	20	0.02
4045-1150	4.5	11.5	5,300	660	11.5	0.9	4,250	520	11.5	0.45
4050-1250	5	12.5	4,800	680	12.5	1	3,850	530	12.5	0.5
4050-1500		15	4,400	680	15	0.5	3,850	530	15	0.25
4050-2000		20	3,600	580	20	0.1	3,850	530	20	0.05
4050-2500		25	3,600	580	25	0.05	3,850	530	25	0.025
4055-1400	5.5	14	4,350	680	14	1.1	3,500	530	14	0.55
4060-1500	6	15	4,000	680	15	1.2	3,200	540	15	0.6
4060-1800		18	3,600	680	18	0.6	3,200	540	18	0.3
4060-2400		24	2,800	560	24	0.12	3,200	540	24	0.06
4060-3000		30	2,800	560	30	0.06	3,200	540	30	0.03
4065-1650	6.5	16.5	3,500	660	16.5	1.3	2,850	530	16.5	0.65

- Ø3mm Shank V Series
- UDC-PCD Series
- CBN Series
- Square
 - Long Neck Square
- Radius
 - Long Neck Radius
 - Taper Neck Radius
- Ball
 - Ball / Long Shank Ball
 - Long Neck Ball
 - Taper Neck Ball
- Taper
 - Taper
- Barrel
- Spiral V Cutter
- Drill
- Technical Data

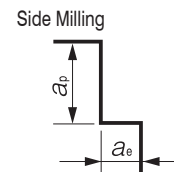

Milling Conditions for CXES

Side Milling

WORK MATERIAL			CARBON STEELS S45C / S50C Annealed Materials (~225HB)				ALLOY STEELS SK / SCM Annealed Materials (225~325HB)				STAINLESS STEELS SUS304 Use water soluble or oil coolant.			
Model Number	Outside Diameter (mm)	Length of Cut (mm)	Spindle Speed (min ⁻¹)	Feed Rate (mm/min)	a_p Axial Depth (mm)	a_e Radial Depth (mm)	Spindle Speed (min ⁻¹)	Feed Rate (mm/min)	a_p Axial Depth (mm)	a_e Radial Depth (mm)	Spindle Speed (min ⁻¹)	Feed Rate (mm/min)	a_p Axial Depth (mm)	a_e Radial Depth (mm)
4070-1050	7	10.5	3,900	1,450	10.5	0.7	3,550	1,120	10.5	0.7	3,550	760	10.5	0.35
		17.5	3,900	1,450	17.5	1.4	3,550	1,120	17.5	1.4	3,550	760	17.5	0.7
4075-1900	7.5	19	3,500	1,400	19	1.5	3,250	1,100	19	1.5	3,250	750	19	0.75
4080-2000	8	20	3,000	1,300	20	1.6	2,900	1,050	20	1.6	2,900	720	20	0.8
4080-2400		24	2,800	1,230	24	0.8	2,600	1,050	24	0.8	2,600	600	24	0.4
4080-3200		32	2,400	1,090	32	0.16	2,000	800	32	0.16	2,100	360	32	0.16
4080-4000		40	2,400	1,090	40	0.16	2,000	800	40	0.16	2,100	360	40	0.16
4085-2150	8.5	21.5	2,550	1,200	21.5	1.7	2,450	1,000	21.5	1.7	2,450	680	21.5	0.85
4090-1350	9	13.5	2,250	1,150	13.5	0.9	2,150	980	13.5	0.9	2,150	650	13.5	0.45
4090-2250		22.5	2,250	1,150	22.5	1.8	2,150	980	22.5	1.8	2,150	650	22.5	0.9
4095-2400	9.5	24	1,950	1,050	24	1.9	1,900	950	24	1.9	1,900	620	24	0.95
4100-2500	10	25	1,600	1,000	25	2	1,500	900	25	2	1,500	580	25	1
4100-3000		30	1,500	900	30	1	1,500	850	30	1	1,500	580	30	0.5
4100-4000		40	1,300	800	40	0.2	1,500	750	40	0.2	1,500	580	40	0.2
4100-5000		50	1,300	800	50	0.2	1,500	750	50	0.2	1,500	580	50	0.2
4110-1650	11	16.5	1,400	900	16.5	1.1	1,350	830	16.5	1.1	1,350	560	16.5	0.55
4110-2750		27.5	1,400	900	27.5	2.2	1,350	830	27.5	2.2	1,350	560	27.5	1.1
4120-3000	12	30	1,200	800	30	2.4	1,200	750	30	2.4	1,200	540	30	1.2
4120-3600		36	1,150	750	36	1.2	1,150	720	36	1.2	1,150	540	36	0.6
4120-4800		48	1,050	700	48	0.24	1,050	660	48	0.24	1,050	500	48	0.24
4120-6000		60	1,050	700	60	0.24	1,050	660	60	0.24	1,050	500	60	0.24
4130-1950	13	19.5	1,100	650	19.5	1.3	1,100	600	19.5	1.3	1,000	460	19.5	0.65
4160-4000	16	40	1,000	500	40	3.2	1,000	440	40	3.2	720	340	40	1.6

φ3mm Shank V Series

UDC-PCD Series

CBN Series

Square
Long Neck Square

Radius
Long Neck Radius
Taper Neck Radius

Ball / Long Shank Ball
Long Neck Ball
Taper Neck Ball

Taper

Barrel

Spiral V Cutter

Drill

Technical Data

Milling Conditions for CXES

4 Flutes

WORK MATERIAL			PREHARDENED STEELS HPM / NAK (30~45HRC)				HARDENED STEELS SKD / SKT / STAVAX (45~55HRC)			
Model Number	Outside Diameter (mm)	Length of Cut (mm)	Spindle Speed (min ⁻¹)	Feed Rate (mm/min)	a_p Axial Depth (mm)	a_e Radial Depth (mm)	Spindle Speed (min ⁻¹)	Feed Rate (mm/min)	a_p Axial Depth (mm)	a_e Radial Depth (mm)
4070-1050	7	10.5	3,150	640	10.5	0.7	2,550	520	10.5	0.35
4070-1750		17.5	3,150	640	17.5	1.4	2,550	520	17.5	0.7
4075-1900	7.5	19	2,850	620	19	1.5	2,250	510	19	0.75
4080-2000	8	20	2,500	600	20	1.6	2,000	500	20	0.8
4080-2400		24	2,350	600	24	0.8	2,150	500	24	0.4
4080-3200		32	2,050	530	32	0.16	2,150	400	32	0.08
4080-4000		40	2,050	530	40	0.08	2,150	400	40	0.04
4085-2150	8.5	21.5	2,150	550	21.5	1.7	1,700	490	21.5	0.85
4090-1350	9	13.5	1,950	520	13.5	0.9	1,500	480	13.5	0.45
4090-2250		22.5	1,950	520	22.5	1.8	1,500	480	22.5	0.9
4095-2400	9.5	24	1,750	480	24	1.9	1,350	470	24	0.95
4100-2500	10	25	1,500	430	25	2	1,200	450	25	1
4100-3000		30	1,500	430	30	1	1,200	450	30	0.5
4100-4000		40	1,500	430	40	0.2	1,200	450	40	0.1
4100-5000		50	1,500	430	50	0.1	1,200	450	50	0.05
4110-1650	11	16.5	1,250	380	16.5	1.1	1,060	430	16.5	0.55
4110-2750		27.5	1,250	380	27.5	2.2	1,060	430	27.5	1.1
4120-3000	12	30	1,000	320	30	2.4	960	420	30	1.2
4120-3600		36	1,000	320	36	1.2	930	400	36	0.6
4120-4800		48	1,000	320	48	0.24	870	360	48	0.12
4120-6000		60	1,000	320	60	0.12	870	360	60	0.06
4130-1950	13	19.5	1,000	260	19.5	1.3	890	350	19.5	0.65
4160-4000	16	40	1,000	220	40	3.2	720	280	40	1.6

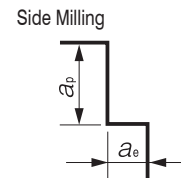

- Ø3mm Shank V Series
- UDC-PCD Series
- CBN Series
- Square
 - Long Neck Square
- Radius
 - Long Neck Radius
 - Taper Neck Radius
- Ball
 - Ball / Long Shank Ball
 - Long Neck Ball
 - Taper Neck Ball
- Taper
 - Taper
- Barrel
- Spiral V Cutter
- Drill
- Technical Data

Milling Conditions for CXES

Slotting

WORK MATERIAL			CARBON STEELS S45C / S50C Annealed Materials (~225HB)			ALLOY STEELS SK / SCM Annealed Materials (225~325HB)			STAINLESS STEELS SUS304 Use water soluble or oil coolant.		
Model Number	Outside Diameter (mm)	Length of Cut (mm)	Spindle Speed (min ⁻¹)	Feed Rate (mm/min)	a _p Axial Depth (mm)	Spindle Speed (min ⁻¹)	Feed Rate (mm/min)	a _p Axial Depth (mm)	Spindle Speed (min ⁻¹)	Feed Rate (mm/min)	a _p Axial Depth (mm)
4010-0250	1	2.5	18,000	200	1	18,000	200	1	14,500	220	0.5
4010-0300		3	18,000	190	0.5※	18,000	190	0.5※	14,300	210	0.25※
4010-0400		4	18,000	170	0.5※	18,000	170	0.5※	12,500	190	0.25※
4010-0500		5	18,000	170	0.5※	18,000	170	0.5※	12,500	190	0.25※
4015-0375	1.5	3.75	13,500	320	1.5	13,500	280	1.5	13,300	240	0.75
4015-0600		6	13,500	290	0.75※	13,500	250	0.75※	12,700	210	0.375※
4020-0500	2	5	11,000	460	2	11,000	320	2	12,200	260	1
4020-0600		6	11,000	440	1※	11,000	310	1※	12,000	240	0.5※
4020-0800		8	11,000	400	1※	11,000	290	1※	11,600	200	0.5※
4020-1000		10	11,000	400	1※	11,000	290	1※	11,600	200	0.5※
4025-0625	2.5	6.25	9,500	540	2.5	9,500	360	2.5	11,000	310	1.25
4025-1000		10	9,500	480	1.25※	9,500	330	1.25※	10,400	250	0.625※
4030-0750	3	7.5	8,500	600	3	8,500	400	3	10,000	360	1.5
4030-0900		9	8,500	550	3	8,500	360	3	9,100	310	1.5
4030-1200		12	8,500	450	1.5※	8,500	280	1.5※	7,300	210	0.75※
4030-1500		15	8,500	450	1.5※	8,500	280	1.5※	7,300	210	0.75※
4035-0900	3.5	9	7,800	620	3.5	7,500	420	3.5	8,600	380	1.75
4040-1000	4	10	7,200	650	4	6,700	450	4	7,500	400	2
4040-1200		12	7,200	580	4	6,700	400	4	6,600	320	2
4040-1600		16	7,200	440	2※	6,700	300	2※	4,800	200	1※
4040-2000		20	7,200	440	2※	6,700	300	2※	4,800	200	1※
4045-1150	4.5	11.5	6,550	670	4.5	6,000	470	4.5	6,300	430	2.25
4050-1250	5	12.5	6,000	700	5	5,400	500	5	5,400	460	2.5
4050-1500		15	6,000	600	5	5,400	430	5	4,600	350	2.5
4050-2000		20	6,000	400	2.5※	5,400	290	2.5※	3,000	170	1.25※
4050-2500		25	6,000	400	2.5※	5,400	290	2.5※	3,000	170	1.25※
4055-1400	5.5	14	5,450	700	5.5	4,900	500	5.5	4,900	460	2.75
Milling Amount (mm)			a _p =1D ※a _p =0.5D			a _p =1D ※a _p =0.5D			a _p =0.5D ※a _p =0.25D		

- φ3mm Shank V Series
- UDC-PCD Series
- CBN Series
- Square
- Long Neck Square
- Radius
- Long Neck Radius
- Taper Neck Radius
- Ball / Long Shank Ball
- Long Neck Ball
- Taper Neck Ball
- Taper
- Barrel
- Spiral V Cutter
- Drill
- Technical Data

Milling Conditions for CXES

4 Flutes

WORK MATERIAL			PREHARDENED STEELS HPM / NAK (30~45HRC)			HARDENED STEELS SKD / SKT / STAVAX (45~55HRC)		
Model Number	Outside Diameter (mm)	Length of Cut (mm)	Spindle Speed (min ⁻¹)	Feed Rate (mm/min)	a _p Axial Depth (mm)	Spindle Speed (min ⁻¹)	Feed Rate (mm/min)	a _p Axial Depth (mm)
4010-0250	1	2.5	12,900	130	1	12,900	50	0.3※
4010-0300		3	12,800	120	0.5※2	N/A	N/A	N/A
4010-0400		4	12,100	100	0.5※2	N/A	N/A	N/A
4010-0500		5	N/A	N/A	N/A	N/A	N/A	N/A
4015-0375	1.5	3.75	10,500	180	1.5	10,500	100	0.45※
4015-0600		6	10,200	150	0.75※2	N/A	N/A	N/A
4020-0500	2	5	9,350	220	2	9,350	150	0.6※
4020-0600		6	9,300	200	1※2	N/A	N/A	N/A
4020-0800		8	8,600	160	1※2	N/A	N/A	N/A
4020-1000		10	N/A	N/A	N/A	N/A	N/A	N/A
4025-0625	2.5	6.25	8,300	270	2.5	8,300	240	0.75※
4025-1000		10	8,000	210	1.25※2	N/A	N/A	N/A
4030-0750	3	7.5	7,400	320	3	7,400	360	1.5
4030-0900		9	7,050	270	3	N/A	N/A	N/A
4030-1200		12	6,350	170	1.5※2	N/A	N/A	N/A
4030-1500		15	N/A	N/A	N/A	N/A	N/A	N/A
4035-0900	3.5	9	6,500	350	3.5	6,500	370	1.75
4040-1000	4	10	5,900	390	4	5,900	380	2
4040-1200		12	5,500	300	4	N/A	N/A	N/A
4040-1600		16	4,700	160	2※2	N/A	N/A	N/A
4040-2000		20	N/A	N/A	N/A	N/A	N/A	N/A
4045-1150	4.5	11.5	5,300	410	4.5	5,300	390	2.25
4050-1250	5	12.5	4,800	440	5	4,800	410	2.5
4050-1500		15	4,400	320	5	N/A	N/A	N/A
4050-2000		20	3,600	160	2.5※2	N/A	N/A	N/A
4050-2500		25	N/A	N/A	N/A	N/A	N/A	N/A
4055-1400	5.5	14	4,350	440	5.5	4,350	420	2.75
Milling Amount (mm)			※1 a _p =1D ※2 a _p =0.8D ※3 a _p =0.5D			※1 a _p =0.5D ※2 a _p =0.3D		

Slotting

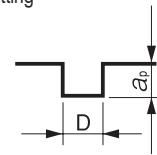

D : Outside Diameter(mm)

- φ3mm Shank V Series
- UDC-PCD Series
- CBN Series
- Square
 - Long Neck Square
- Radius
 - Long Neck Radius
 - Taper Neck Radius
- Ball
 - Ball / Long Shank Ball
 - Long Neck Ball
 - Taper Neck Ball
- Taper
 - Taper
- Barrel
- Spiral V Cutter
- Drill
- Technical Data

Milling Conditions for CXES

Slotting

WORK MATERIAL			CARBON STEELS S45C / S50C Annealed Materials (~225HB)			ALLOY STEELS SK / SCM Annealed Materials (225~325HB)			STAINLESS STEELS SUS304 Use water soluble or oil coolant.		
Model Number	Outside Diameter (mm)	Length of Cut (mm)	Spindle Speed (min ⁻¹)	Feed Rate (mm/min)	a _p Axial Depth (mm)	Spindle Speed (min ⁻¹)	Feed Rate (mm/min)	a _p Axial Depth (mm)	Spindle Speed (min ⁻¹)	Feed Rate (mm/min)	a _p Axial Depth (mm)
4060-1500	6	15	5,000	700	6	4,500	500	6	4,500	460	3
4060-1800		18	5,000	560	6	4,500	410	6	3,700	320	3
4060-2400		24	5,000	280	3※	4,500	230	3※	2,100	150	1.5※
4060-3000		30	5,000	280	3※	4,500	230	3※	2,100	150	1.5※
4065-1650	6.5	16.5	4,400	650	6.5	3,950	450	6.5	3,950	420	3.25
4070-1050	7	10.5	3,900	300	7	3,550	200	7	3,550	200	3.5
4070-1750		17.5	3,900	600	7	3,550	400	7	3,550	390	3.5
4075-1900	7.5	19	3,500	550	7.5	3,250	380	7.5	3,250	380	3.75
4080-2000	8	20	3,000	500	8	2,900	360	8	2,900	360	4
4080-2400		24	2,800	330	8	2,600	260	8	2,600	240	4
4080-3200		32	2,400	230	4※	2,000	180	4※	2,000	130	2※
4080-4000		40	2,400	230	4※	2,000	180	4※	2,000	130	2※
4085-2150	8.5	21.5	2,550	450	8.5	2,450	330	8.5	2,450	310	4.25
4090-1350	9	13.5	2,250	210	9	2,150	160	9	2,150	140	4.5
4090-2250		22.5	2,250	420	9	2,150	300	9	2,150	260	4.5
4095-2400	9.5	24	1,950	400	9.5	1,900	300	9.5	1,900	250	4.75
4100-2500	10	25	1,600	380	10	1,500	270	10	1,500	220	5
4100-3000		30	1,500	250	10	1,500	180	10	1,500	190	5
4100-4000		40	1,300	180	5※	1,500	150	5※	1,500	130	2.5※
4100-5000		50	1,300	180	5※	1,500	150	5※	1,500	130	2.5※
4110-1650	11	16.5	1,400	170	11	1,350	120	11	1,350	100	5.5
4110-2750		27.5	1,400	340	11	1,350	240	11	1,350	200	5.5
4120-3000	12	30	1,200	300	12	1,200	210	12	1,200	180	6
4120-3600		36	1,150	200	12	1,150	140	12	1,150	150	6
4120-4800		48	1,050	160	6※	1,050	120	6※	1,050	100	3※
4120-6000		60	1,050	160	6※	1,050	120	6※	1,050	100	3※
4130-1950	13	19.5	1,100	190	13	1,100	90	13	1,000	80	6.5
4160-4000	16	40	1,000	400	8※	1,000	280	8※	720	240	4※
Milling Amount (mm)			a _p =1D ※a _p =0.5D			a _p =1D ※a _p =0.5D			a _p =0.5D ※a _p =0.25D		

- φ3mm Shank V Series
- UDC-PCD Series
- CBN Series
- Square
- Long Neck Square
- Radius
- Long Neck Radius
- Taper Neck Radius
- Ball / Long Shank Ball
- Long Neck Ball
- Taper Neck Ball
- Taper
- Barrel
- Spiral V Cutter
- Drill
- Technical Data

Milling Conditions for CXES

4 Flutes

WORK MATERIAL			PREHARDENED STEELS HPM / NAK (30~45HRC)			HARDENED STEELS SKD / SKT / STAVAX (45~55HRC)		
Model Number	Outside Diameter (mm)	Length of Cut (mm)	Spindle Speed (min ⁻¹)	Feed Rate (mm/min)	a _p Axial Depth (mm)	Spindle Speed (min ⁻¹)	Feed Rate (mm/min)	a _p Axial Depth (mm)
4060-1500	6	15	4,000	440	6	4,000	440	3
4060-1800		18	3,600	290	6	N/A	N/A	N/A
4060-2400		24	2,800	140	3*2	N/A	N/A	N/A
4060-3000		30	N/A	N/A	N/A	N/A	N/A	N/A
4065-1650	6.5	16.5	3,500	420	6.5	3,500	400	3.25
4070-1050	7	10.5	3,150	190	7	3,150	190	3.5
4070-1750		17.5	3,150	410	7	3,150	380	3.5
4075-1900	7.5	19	2,850	400	7.5	2,850	370	3.75
4080-2000	8	20	2,500	390	8	2,500	340	4
4080-2400		24	2,350	200	8	N/A	N/A	N/A
4080-3200		32	2,050	110	4*2	N/A	N/A	N/A
4080-4000		40	N/A	N/A	N/A	N/A	N/A	N/A
4085-2150	8.5	21.5	2,150	330	8.5	2,150	300	4.25
4090-1350	9	13.5	1,950	150	9	1,950	140	4.5
4090-2250		22.5	1,950	300	9	1,950	270	4.5
4095-2400	9.5	24	1,750	270	9.5	1,750	270	4.75
4100-2500	10	25	1,500	220	10	1,500	240	5
4100-3000		30	1,500	180	8*1	N/A	N/A	N/A
4100-4000		40	1,200	90	5*2	N/A	N/A	N/A
4100-5000		50	N/A	N/A	N/A	N/A	N/A	N/A
4110-1650	11	16.5	1,250	100	11	1,350	110	5.5
4110-2750		27.5	1,250	200	11	1,350	230	5.5
4120-3000	12	30	1,000	180	12	1,200	220	6
4120-3600		36	1,000	140	9.6*1	N/A	N/A	N/A
4120-4800		48	800	70	6*2	N/A	N/A	N/A
4120-6000		60	N/A	N/A	N/A	N/A	N/A	N/A
4130-1950	13	19.5	1,000	80	13	1,100	90	6.5
4160-4000	16	40	1,000	240	8*2	1,000	220	4.8*
Milling Amount (mm)			a _p = 1D ※1 a _p = 0.8D ※2 a _p = 0.5D			a _p = 0.5D ※ a _p = 0.3D		

Slotting

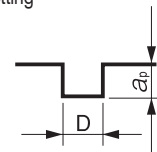

D : Outside Diameter(mm)

- Ø3mm Shank V Series
- UDC-PCD Series
- CBN Series
- Square
 - Long Neck Square
- Radius
 - Long Neck Radius
 - Taper Neck Radius
- Ball
 - Ball / Long Shank Ball
 - Long Neck Ball
 - Taper Neck Ball
- Taper
 - Taper
- Barrel
- Spiral V Cutter
- Drill
- Technical Data

Note:

- Decrease both spindle speed and feed rate proportionally in case of chattering.
- These milling parameters are calculated based on the shortest overhang length. Longer overhangs may require an adjustment to the milling parameters.
- Reduce the milling amount and feed rate in accordance with required milling precision.
- Every coolant offers stable milling.
- Recommend water soluble or oil coolant for Stainless Steels and Copper.

∅3mm Shank V Series	
UDC-PCD Series	
CBN Series	
Square	Square
Long Neck Square	
Radius	Radius
Long Neck Radius	
Taper Neck Radius	
Ball / Long Shank Ball	Ball
Long Neck Ball	
Taper Neck Ball	
Taper	Taper
Barrel	
Spiral V Cutter	
Drill	
Technical Data	

Milling Example CXES $\phi 10$

S55C

Roughing and finishing with a single tool

Size : 105 mm \times 92 mm \times 20 mm

Tool	Roughing		Finishing	
	Conventional 4 Flutes	CXES 4100-2500	CXES 4100-2500	
Milling Part	Side / Slot		Bottom	Side
Spindle Speed	2,600 min ⁻¹	2,500 min ⁻¹	1,600 min ⁻¹	
Feed Rate	525 mm/min	1,500 mm/min	380 mm/min	1,000 mm/min
a_p	20 mm	19.9 mm	0.1 mm	0.1 mm
a_e	0.7 mm	1.2 mm	0.4 mm	0.1 mm
Coolant	Oil		Oil	
Milling Distance	—	11.5 m	1.5 m	0.7 m
Efficiency*	1	4.8	—	

* Efficiency : Feed Rate \times Axial Depth \times Radial Depth

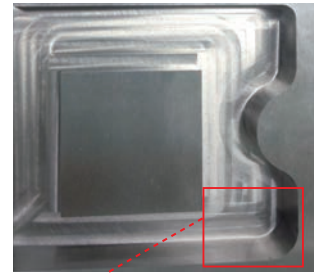

Enlarged view

4.8 times milling efficiency compared to conventional 4 flutes when roughing

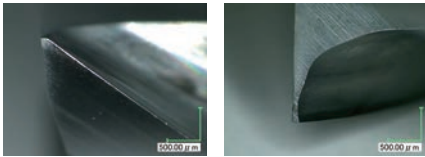

Total Milling Distance 21 m

Finishing surface

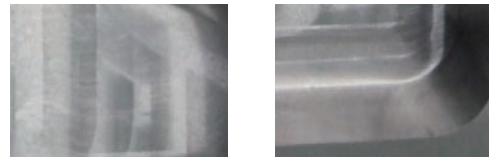

Bottom

Side

No surface burrs after finishing process

Milling Example CXES $\phi 6$

SUS304

Tool	CXES4060-1500	
	Roughing	Finishing
Milling Method	Roughing	Finishing
Spindle Speed	4,500 min ⁻¹	4,500 min ⁻¹
Feed Rate	810 mm/min	400 mm/min
a_p	15 mm	15 mm
a_e	0.6 mm	2.5 mm (Standing Wall Finishing Allowance 0.1mm)
Overhang Length	20 mm	20 mm
Coolant	Water Soluble (Through Spindle)	Water Soluble (Through Spindle)
Cycle Time	1:11:29	0:18:43

CXES Milling Video



Tool Wearing after Roughing Process

End Profile

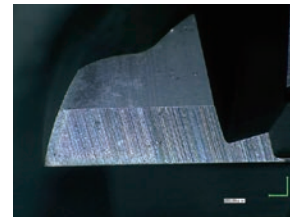

Peripheral Cutting Edge

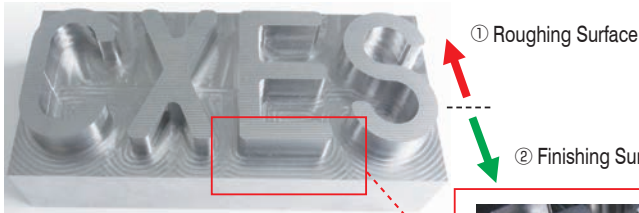

Enlarged view

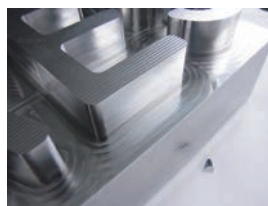

Smooth Side Finishing

4 Flutes

$\phi 3$ mm Shank
V Series

UDC-PCD
Series

CBN
Series

Square

Square

Long Neck
Square

Radius

Radius

Long Neck
Radius

Taper Neck
Radius

Ball / Long
Shank Ball

Ball

Long Neck
Ball

Taper Neck
Ball

Taper

Taper

Barrel

Spiral
V Cutter

Drill

Technical Data



Size $\phi 6 \sim \phi 12$

CESUS



Material Applications (★ Highly Recommended ● Recommended ○ Suggested)

Work Material																	
Carbon Steels S45C S55C	Alloy Steels SK / SCM SUS	Prehardened Steels NAK HPM	Hardened Steels					Cast Iron	Aluminum Alloys	Graphite	Copper	Plastics	Glass Filled Plastics	Titanium Alloys	Heat Resistant Alloys	Cemented Carbide	Hard Brittle (Non-Metallic) Materials
			~50HRC	~55HRC	~60HRC	~65HRC	~70HRC										
●	★	○									○			○	○		

Features

4 Flute Highly Efficient Square End Mills for stainless steels.

Variable pitch & variable helix designed for milling stainless steels offers higher efficiency milling. New coating 'UTSCOAT' with excellent adhesion offers high resistance to breakage.

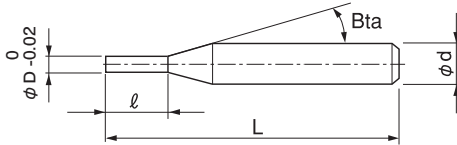

The shank taper angle shown is not an exact value and to avoid contact with the workpiece, we recommend the user controls the precise value of this angle. Shank taper angle should not make contact with the work piece.

Design features

Variable pitch & variable helix designed for milling stainless steels.

Variable pitch

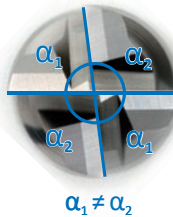

Variable helix

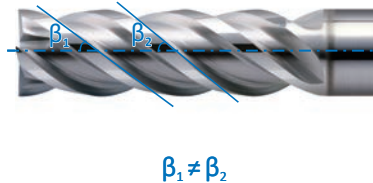

Minimizes chattering

Stable milling under highly efficient conditions

Features of UTSCOAT

Improve the resistance to adhesion by adding a highly lubricant layer onto the high hardness and high toughness UTSCOAT.

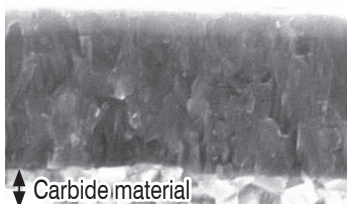

- ★ Ultra lubricant layer
- ◆ Ultra hard layer
- ◆ High toughness and adhesion layer

◆ Carbide material

Reduce adhesion

High resistance to breakage with high lubricity

Total 21 models

Unit (mm)

Model Number	Outside Diameter ϕD	Length of Cut ℓ	Shank Taper Angle Bta	Overall Length L	Shank Diameter ϕd	Suggested Retail Price ¥
CESUS 4060-0900	6	9	—	60	6	8,500
CESUS 4060-1300		13		60	6	8,500
CESUS 4060-1800		18		60	6	9,350
CESUS 4070-1050	7	10.5	16°	70	8	10,500
CESUS 4070-1600		16		70	8	10,500
CESUS 4070-2100		21		70	8	11,550
CESUS 4080-1200	8	12	—	70	8	10,500
CESUS 4080-1900		19		70	8	10,500
CESUS 4080-2400		24		70	8	11,550
CESUS 4090-1350	9	13.5	16°	80	10	12,500
CESUS 4090-1900		19		80	10	12,500
CESUS 4090-2700		27		80	10	13,750
CESUS 4100-1500	10	15	—	80	10	12,500
CESUS 4100-2200		22		80	10	12,500
CESUS 4100-3000		30		80	10	13,750
CESUS 4110-1650	11	16.5	16°	100	12	17,800
CESUS 4110-2200		22		100	12	17,800
CESUS 4110-3300		33		100	12	19,580
CESUS 4120-1800	12	18	—	100	12	17,800
CESUS 4120-2600		26		100	12	17,800
CESUS 4120-3600		36		100	12	19,580

4 Flutes

$\phi 3$ mm Shank V Series

UDC-PCD Series

CBN Series

Square

Long Neck Square

Radius

Long Neck Radius

Taper Neck Radius

Ball / Long Shank Ball

Long Neck Ball

Taper Neck Ball

Taper

Barrel

Spiral V Cutter

Drill

Technical Data

Milling Conditions for CESUS

Side Milling

WORK MATERIAL			CARBON STEELS S45C / S50C Annealed Materials (~225HB)				ALLOY STEELS SK / SCM Annealed Materials (225~325HB)				STAINLESS STEELS SUS304 Use water soluble or oil coolant.			
Model Number	Outside Diameter (mm)	Length of Cut (mm)	Spindle Speed (min ⁻¹)	Feed Rate (mm/min)	a _p Axial Depth (mm)	a _e Radial Depth (mm)	Spindle Speed (min ⁻¹)	Feed Rate (mm/min)	a _p Axial Depth (mm)	a _e Radial Depth (mm)	Spindle Speed (min ⁻¹)	Feed Rate (mm/min)	a _p Axial Depth (mm)	a _e Radial Depth (mm)
4060-0900	6	9	6,000	1,600	9	1.2	6,000	1,100	9	1.2	6,000	1,100	9	1.2
4060-1300		13	6,000	1,600	13	1.2	6,000	1,100	13	1.2	6,000	1,100	13	1.2
4060-1800		18	6,000	1,170	18	1.2	4,800	800	18	1.2	4,800	800	18	1.2
4070-1050	7	10.5	5,000	1,450	10.5	1.4	5,000	1,025	10.5	1.4	5,000	1,025	10.5	1.4
4070-1600		16	5,000	1,450	16	1.4	5,000	1,025	16	1.4	5,000	1,025	16	1.4
4070-2100		21	5,000	1,060	21	1.4	4,000	750	21	1.4	4,000	750	21	1.4
4080-1200	8	12	4,300	1,300	12	1.6	4,300	950	12	1.6	4,300	950	12	1.6
4080-1900		19	4,300	1,300	19	1.6	4,300	950	19	1.6	4,300	950	19	1.6
4080-2400		24	4,300	950	24	1.6	3,400	695	24	1.6	3,400	695	24	1.6
4090-1350	9	13.5	3,700	1,150	13.5	1.8	3,700	875	13.5	1.8	3,700	875	13.5	1.8
4090-1900		19	3,700	1,150	19	1.8	3,700	875	19	1.8	3,700	875	19	1.8
4090-2700		27	3,700	840	27	1.8	2,960	640	27	1.8	2,960	640	27	1.8
4100-1500	10	15	3,200	1,000	15	2	3,200	800	15	2	3,200	800	15	2
4100-2200		22	3,200	1,000	22	2	3,200	800	22	2	3,200	800	22	2
4100-3000		30	3,200	730	30	2	2,650	580	30	2	2,650	580	30	2
4110-1650	11	16.5	2,900	900	16.5	2.2	2,900	725	16.5	2.2	2,900	725	16.5	2.2
4110-2200		22	2,900	900	22	2.2	2,900	725	22	2.2	2,900	725	22	2.2
4110-3300		33	2,900	650	33	2.2	2,400	530	33	2.2	2,400	530	33	2.2
4120-1800	12	18	2,650	800	18	2.4	2,650	650	18	2.4	2,650	650	18	2.4
4120-2600		26	2,650	800	26	2.4	2,650	650	26	2.4	2,650	650	26	2.4
4120-3600		36	2,650	580	36	2.4	2,200	475	36	2.4	2,200	475	36	2.4
Milling Amount (mm)			a _p : All Flute a _e : 0.2D				a _p : All Flute a _e : 0.2D				a _p : All Flute a _e : 0.2D			

Slotting

WORK MATERIAL			CARBON STEELS S45C / S50C Annealed Materials (~225HB)			ALLOY STEELS SK / SCM Annealed Materials (225~325HB)			STAINLESS STEELS SUS304 Use water soluble or oil coolant.		
Model Number	Outside Diameter (mm)	Length of Cut (mm)	Spindle Speed (min ⁻¹)	Feed Rate (mm/min)	a _p Axial Depth (mm)	Spindle Speed (min ⁻¹)	Feed Rate (mm/min)	a _p Axial Depth (mm)	Spindle Speed (min ⁻¹)	Feed Rate (mm/min)	a _p Axial Depth (mm)
4060-0900	6	9	6,000	700	6	6,000	700	6	6,000	700	6
4060-1300		13	6,000	700	6	6,000	700	6	6,000	700	6
4060-1800		18	6,000	560	6	4,200	350	6	4,200	350	6
4070-1050	7	10.5	5,000	625	7	5,000	625	7	5,000	625	7
4070-1600		16	5,000	625	7	5,000	625	7	5,000	625	7
4070-2100		21	5,000	500	7	3,500	300	7	3,500	300	7
4080-1200	8	12	4,300	550	8	4,300	550	8	4,000	500	8
4080-1900		19	4,300	550	8	4,300	550	8	4,000	500	8
4080-2400		24	4,300	440	8	3,000	275	8	3,000	275	8
4090-1350	9	13.5	3,500	475	9	3,500	475	9	3,150	430	9
4090-1900		19	3,500	475	9	3,500	475	9	3,150	430	9
4090-2700		27	3,500	380	9	2,450	240	9	2,450	240	9
4100-1500	10	15	2,900	400	10	2,900	400	10	2,900	400	10
4100-2200		22	2,900	400	10	2,900	400	10	2,900	400	10
4100-3000		30	2,900	320	10	2,000	200	10	2,000	200	10
4110-1650	11	16.5	2,650	340	11	2,650	340	11	2,380	300	11
4110-2200		22	2,650	340	11	2,650	340	11	2,380	300	11
4110-3300		33	2,650	270	11	1,820	170	11	1,820	170	11
4120-1800	12	18	2,420	300	12	2,420	300	12	2,420	300	12
4120-2600		26	2,420	300	12	2,420	300	12	2,420	300	12
4120-3600		36	2,420	240	12	1,650	150	12	1,650	150	12
Milling Amount (mm)			a _p : 1D			a _p : 1D			a _p : 1D		

Note:

- Decrease both spindle speed and feed rate proportionally in case of chattering.
- These milling parameters are calculated based on the shortest overhang length. Longer overhangs may require an adjustment to the milling parameters.
- Reduce the milling amount and feed rate in accordance with required milling precision.
- Every coolant offers stable milling.
- Recommend water soluble or oil coolant for Stainless Steels.

Side Milling

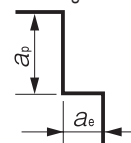

Slotting

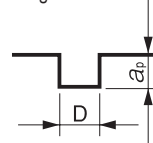

D : Outside Diameter (mm)

Milling Example for Slotting Cesus $\phi 10 \times L22$

SUS304

Tool	CESUS 4100-2200
Spindle Speed	3,200 min ⁻¹
Feed Rate	900 mm/min*
a_p	10 mm
Coolant	Water Soluble
Milling Distance	100 mm

*Milled by higher efficiency conditions than catalogue conditions to evaluate the tool performance.

Milling image

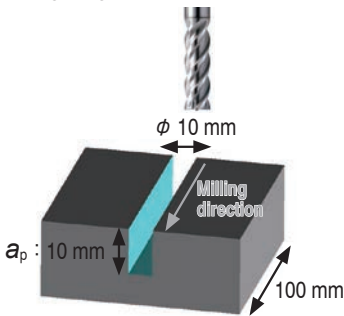

Peripheral (tip)

Peripheral (around a_p)

Milling surface (bottom)

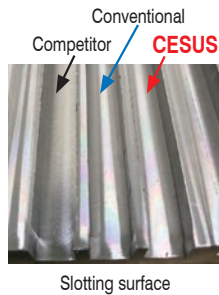

CESUS

Conventional

Competitor

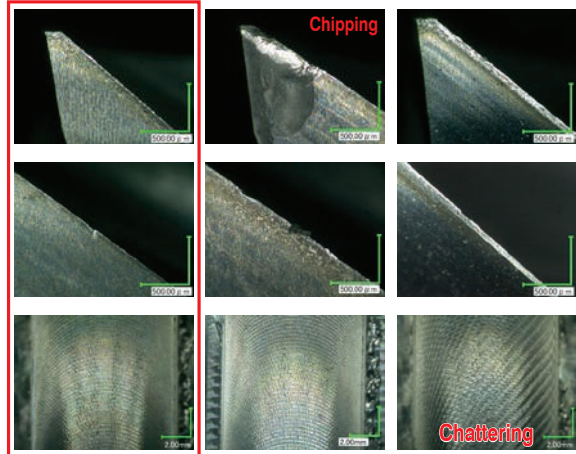

CESUS offers stable milling with less chattering under highly efficient conditions.

Milling Example for Side Milling Cesus $\phi 10 \times L22$

SUS304

Tool	CESUS 4100-2200
Spindle Speed	2,560 min ⁻¹
Feed Rate	580 mm/min
a_p	10 mm
a_e	2 mm
Coolant	Water Soluble
Milling Distance	64.8 m
Cycle Time	120 min

Milling image

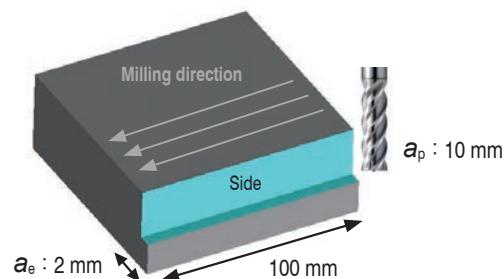

Peripheral (tip)

Milling surface (side)

CESUS

Conventional

Competitor

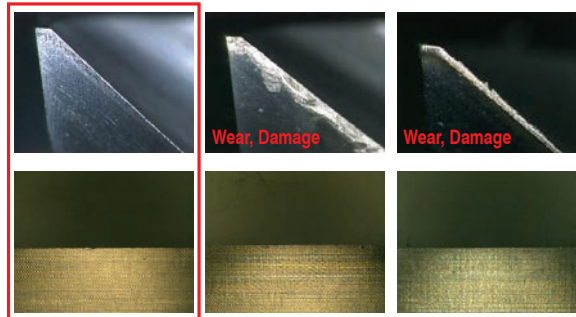

CESUS offers longer tool life with less wear and damage after 120 min of milling! Great surface finish without chattering!

4 Flutes

$\phi 3$ mm Shank V Series

UDC-PCD Series

CBN Series

Square

Long Neck Square

Radius

Long Neck Radius

Taper Neck Radius

Ball / Long Shank Ball

Long Neck Ball

Taper Neck Ball

Taper

Barrel

Spiral V Cutter

Drill

Technical Data



Size $\phi 3 \sim \phi 12$

CRN-ES4000



Material Applications (★ Highly Recommended ● Recommended ○ Suggested)

Work Material																	
Carbon Steels S45C S55C	Alloy Steels SK / SCM SUS	Prehardened Steels NAK HPM	Hardened Steels					Cast Iron	Aluminum Alloys	Graphite	Copper	Plastics	Glass Filled Plastics	Titanium Alloys	Heat Resistant Alloys	Cemented Carbide	Hard Brittle (Non-Metallic) Materials
			~50HRC	~55HRC	~60HRC	~65HRC	~70HRC										
										○	★	○					

Features

CrN COAT offers longer tool life.

Special geometry designed for Copper offers excellent milling performance.

Refer to page 186 for 2 flute CRN-ES.

Diameter Tolerance: $0/-0.02(D \leq 6)$, $0/-0.03(D \geq 8)$

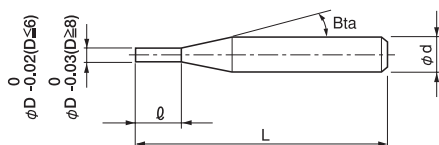

The shank taper angle shown is not an exact value and to avoid contact with the work piece, we recommend the user controls the precise value of this angle. Shank taper angle should not make contact with the work piece.

Total 10 models

Unit (mm)

Model Number	Outside Diameter ϕD	Length of Cut l	Shank Taper Angle B_{ta}	Overall Length L	Shank Diameter ϕd	Suggested Retail Price ¥
CRN-ES 4030-0900	3	9	11°	50	6	4,620
CRN-ES 4030-1200		12	11°	55	6	6,820
CRN-ES 4040-1200	4	12	11°	50	6	4,950
CRN-ES 4040-1600		16	11°	55	6	7,150
CRN-ES 4050-1500	5	15	11°	55	6	5,060
CRN-ES 4060-1800	6	18	—	60	6	5,390
CRN-ES 4060-2400		24	—	65	6	8,250
CRN-ES 4080-2400	8	24	—	80	8	9,480
CRN-ES 4100-3000	10	30	—	100	10	12,720
CRN-ES 4120-3600	12	36	—	100	12	15,840

Milling Conditions for CRN-ES (4 Flutes)

Side Milling

◆3D flute length type

WORK MATERIAL		COPPER C1100			
Model Number	Outside Diameter (mm)	Spindle Speed (min ⁻¹)	Feed Rate (mm/min)	a _p Axial Depth (mm)	a _e Radial Depth (mm)
4030-0900	3	10,000	600	4.5	0.3
4040-1200	4	8,000	650	6	0.4
4050-1500	5	6,500	750	7.5	0.5
4060-1800	6	5,500	750	9	0.6
4080-2400	8	4,200	700	12	0.8
4100-3000	10	3,500	700	15	1
4120-3600	12	2,800	700	18	1.2

◆4D flute length type

WORK MATERIAL		COPPER C1100			
Model Number	Outside Diameter (mm)	Spindle Speed (min ⁻¹)	Feed Rate (mm/min)	a _p Axial Depth (mm)	a _e Radial Depth (mm)
4030-1200	3	5,000	300	7.5	0.15
4040-1600	4	4,000	325	10	0.2
4060-2400	6	3,500	400	15	0.3

Length of Cut		3D Flute Length Type	4D Flute Length Type
Milling			
Side Milling		a _p 1.5D a _e 0.1D	a _p 2.5D a _e 0.05D

Side Milling

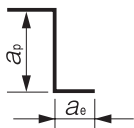

D : Outside Diameter (mm)

Note:

- Decrease both spindle speed and feed rate proportionally in case of chattering.
- Adjust the milling amount and feed rate in accordance with required precision.
- Recommend water soluble or oil coolant.
- Recommended for Pure Copper. Not suitable for Tungsten Copper.

Milling Example $\phi 6$

Pure Copper C1100



CRN-ES $\phi 6 \times L24$

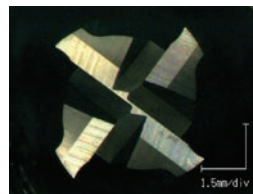

Upper surface

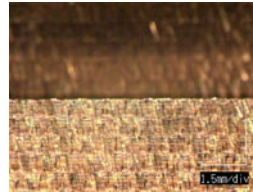

Outlet end

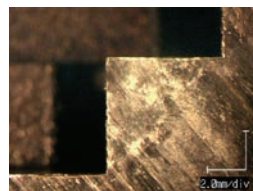

4 flute Square for Steels $\phi 6 \times L24$

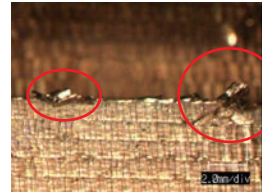
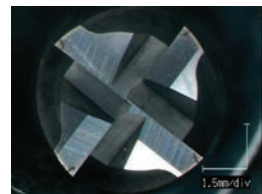

Milling Method	Z-level slotting Side milling
Spindle Speed	3,500 min ⁻¹
Feed Rate	2,500 mm/min
a _p	0.6 mm
a _e	4.2 mm
Coolant	Water Soluble

CRN-ES has a edge shape dedicated to copper processing that emphasizes sharpness compared to steel. More effective in suppressing burrs than for steel!



Size $\phi 3 \sim \phi 10$

DCES4000



Material Applications (★ Highly Recommended ● Recommended ○ Suggested)

Work Material																	
Carbon Steels S45C S55C	Alloy Steels SK / SCM SUS	Prehardened Steels NAK HPM	Hardened Steels					Cast Iron	Aluminum Alloys	Graphite	Copper	Plastics	Glass Filled Plastics	Titanium Alloys	Heat Resistant Alloys	Cemented Carbide	Hard Brittle (Non-Metallic) Materials
			~50HRC	~55HRC	~60HRC	~65HRC	~70HRC										
									○	★	○	○	●				○

Features

Diamond coated 4 flute square end mills for Graphite Electrodes.

New diamond coating with a highly adhesive base layer offers excellent wear resistance and longer tool life.

Refer to page 188 for 2 flute DCES.

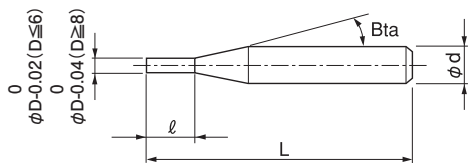

The shank taper angle shown is not an exact value and to avoid contact with the work piece, we recommend the user controls the precise value of this angle. Shank taper angle should not make contact with the work piece.

Total 11 models

Unit (mm)

Model Number	Outside Diameter ϕD	Length of Cut l	Shank Taper Angle Bta	Overall Length L	Shank Diameter ϕd	Suggested Retail Price ¥
DCES 4030-0900	3	9	16°	50	6	20,000
DCES 4030-1200		12		50	6	26,000
DCES 4040-1200	4	12	16°	50	6	21,000
DCES 4040-1600		16		60	6	27,000
DCES 4060-1800	6	18	—	60	6	22,000
DCES 4060-1800L		18		100	6	30,000
DCES 4060-2400		24		60	6	28,000
DCES 4080-2400	8	24	—	80	8	35,000
DCES 4080-3200		32		80	8	41,000
DCES 4100-3000	10	30	—	90	10	48,000
DCES 4100-4000		40		90	10	54,000

Milling Conditions for DCES (4 Flutes)

WORK MATERIAL		GRAPHITE				
Model Number	Outside Diameter (mm)	Spindle Speed (min ⁻¹)	Feed Rate (mm/min)	Side Milling		Slotting
				a _p Axial Depth (mm)	a _e Radial Depth (mm)	a _p Axial Depth (mm)
4030	3	25,000	3,000	6	0.15	0.75
4040	4	19,000	2,350	9	0.2	1
4060	6	13,000	1,800	12	0.48	1.5
4080	8	9,500	1,400	16	0.64	2
4100	10	7,500	1,200	20	0.8	2.5

Slotting

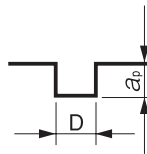

D : Outside Diameter (mm)

Side Milling

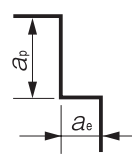

- Note:
- Use a milling machine dedicated for Graphite.
 - Recommend air blow for Graphite.

Other series for Graphite milling

Square / Long Neck Square

(★ Highly Recommended ● Recommended ○ Suggested)

Number of Flutes, Tool Type	Model Number	Appearance	Coating	Size	Aluminum Alloys	Graphite	Copper	Plastics	Glass Filled Plastics	Hard Brittle (Non-Metallic) Materials	Page
					○	★	○	○	○	●	
4 flutes Square	CGE		Non-coat	φ2~φ20	○	★	○	○	○		236
2 flutes Square	DCES 2000		DIA	φ0.2~φ6	○	★	○	○	●	○	188
4 flutes Square	DCES 4000		DIA	φ3~φ10	○	★	○	○	●	○	234
2 flutes Long Neck Square	DCLS		DIA	φ0.4~φ6	○	★	○	○	●	○	266

Long Neck Radius

4 flutes Long Neck Radius	DCLRS		DIA	φ1~φ6	○	★	○	○	●	○	396
---------------------------	-------	--	-----	-------	---	---	---	---	---	---	-----

Ball / Long Neck Ball / Taper Neck Ball

2 flutes Ball	CGB 2000		Non-coat	R0.2~R6	○	★	○	○	○		440
4 flutes Ball	CGB 4000		Non-coat	R2~R10	○	★	○	○	○		458
2 flutes Ball	DCB		DIA	R0.5~R6	○	★	○	○	●	○	438
2 flutes Long Neck Ball	DCLB		DIA	R0.2~R3	○	★	○	○	●	○	512
2 flutes Taper Neck Ball	DCTNB		DIA	R0.5~R1	○	★	○	○	●	○	556

4 Flutes

φ3mm Shank V Series

UDC-PCD Series

CBN Series

Square

Square

Long Neck Square

Radius

Radius

Long Neck Radius

Taper Neck Radius

Ball / Long Shank Ball

Ball

Long Neck Ball

Taper Neck Ball

Taper

Taper

Barrel

Spiral V Cutter

Drill

Technical Data

4 Flutes NON-COAT for Graphite Milling



Size $\phi 2 \sim \phi 20$

CGE



Material Applications (★ Highly Recommended ● Recommended ○ Suggested)

Work Material																	
Carbon Steels S45C S55C	Alloy Steels SK / SCM SUS	Prehardened Steels NAK HPM	Hardened Steels					Cast Iron	Aluminum Alloys	Graphite	Copper	Plastics	Glass Filled Plastics	Titanium Alloys	Heat Resistant Alloys	Cemented Carbide	Hard Brittle (Non-Metallic) Materials
			~50HRC	~55HRC	~60HRC	~65HRC	~70HRC										
									○	★	○	○	○				

Features

Designed for Graphite.
Specific carbide grade offers wear and abrasion resistance.
High helix angle reduces chipping of the work material.

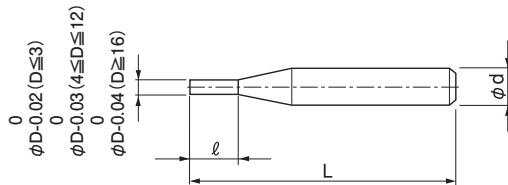

Total 10 models

Unit (mm)

Model Number	Outside Diameter ϕD	Length of Cut ℓ	Overall Length L	Shank Diameter ϕd	Suggested Retail Price ¥
CGE 4020	2	15	60	3	16,800
CGE 4030	3	30	80	3	16,800
CGE 4040	4	30	90	4	17,700
CGE 4050	5	35	100	6	18,900
CGE 4060	6	40	150	6	19,320
CGE 4080	8	40	150	8	24,200
CGE 4100	10	45	180	10	30,580
CGE 4120	12	55	200	12	36,850
CGE 4160	16	70	200	16	56,430
CGE 4200	20	70	200	20	87,230

Milling Conditions for CGE

WORK MATERIAL		GRAPHITE			
		Side Milling			
Model Number	Outside Diameter (mm)	Spindle Speed (min ⁻¹)	Feed Rate (mm/min)	a_o Axial Depth (mm)	a_e Radial Depth (mm)
4020	2	15,900	300	1	0.1
4030	3	15,900	500	1.5	0.15
4040	4	15,900	650	2	0.2
4050	5	12,700	750	2.5	0.25
4060	6	10,600	850	3	0.3
4080	8	8,000	950	4	0.4
4100	10	6,400	1,000	5	0.5
4120	12	5,310	1,000	6	0.6
4160	16	3,980	1,000	8	0.8
4200	20	3,180	1,000	10	1

Milling Amount for side milling (mm)

$$a_o = 0.5D$$

$$a_e = 0.05D$$

D : Outside Diameter (mm)

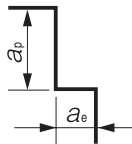

Note:

- Use a milling machine dedicated for Graphite.
- Recommend air blow for Graphite.

Other series for Graphite milling

Square / Long Neck Square

(★ Highly Recommended ● Recommended ○ Suggested)

Number of Flutes, Tool Type	Model Number	Appearance	Coating	Size	Aluminum Alloys	Graphite	Copper	Plastics	Glass Filled Plastics	Hard Brittle (Non-Metallic) Materials	Page
					○	★	○	○	○	●	
4 flutes Square	CGE		Non-coat	$\phi 2 \sim \phi 20$	○	★	○	○	○		236
2 flutes Square	DCES 2000		DIA	$\phi 0.2 \sim \phi 6$	○	★	○	○	●	○	188
4 flutes Square	DCES 4000		DIA	$\phi 3 \sim \phi 10$	○	★	○	○	●	○	234
2 flutes Long Neck Square	DCLS		DIA	$\phi 0.4 \sim \phi 6$	○	★	○	○	●	○	266

Long Neck Radius

4 flutes Long Neck Radius	DCLRS		DIA	$\phi 1 \sim \phi 6$	○	★	○	○	●	○	396
---------------------------	-------	--	-----	----------------------	---	---	---	---	---	---	-----

Ball / Long Neck Ball / Taper Neck Ball

2 flutes Ball	CGB 2000		Non-coat	R0.2~R6	○	★	○	○	○		440
4 flutes Ball	CGB 4000		Non-coat	R2~R10	○	★	○	○	○		458
2 flutes Ball	DCB		DIA	R0.5~R6	○	★	○	○	●	○	438
2 flutes Long Neck Ball	DCLB		DIA	R0.2~R3	○	★	○	○	●	○	512
2 flutes Taper Neck Ball	DCTNB		DIA	R0.5~R1	○	★	○	○	●	○	556

4 Flutes

φ3mm Shank
V Series

UDC-PCD
Series

CBN
Series

Square

Long Neck
Square

Radius

Long Neck
Radius

Taper Neck
Radius

Ball / Long
Shank Ball

Long Neck
Ball

Taper Neck
Ball

Taper

Barrel

Spiral
V Cutter

Drill

Technical Data



Size $\phi 1 \sim \phi 12$

HMS



Material Applications (★ Highly Recommended ● Recommended ○ Suggested)

Work Material																	
Carbon Steels S45C S55C	Alloy Steels SK / SCM SUS	Prehardened Steels NAK HPM	Hardened Steels					Cast Iron	Aluminum Alloys	Graphite	Copper	Plastics	Glass Filled Plastics	Titanium Alloys	Heat Resistant Alloys	Cemented Carbide	Hard Brittle (Non-Metallic) Materials
			~50HRC	~55HRC	~60HRC	~65HRC	~70HRC										
		○	●	●	●	●											

Features

Offering outstanding tool life by selecting appropriate 3, 4 or 6 flutes on each tool diameter.

Highly efficient milling on hard materials up to 65HRC with HARDMAX COAT.

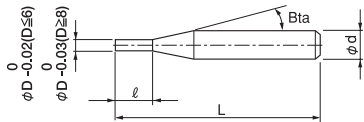

The shank taper angle shown is not an exact value and to avoid contact with the work piece, we recommend the user controls the precise value of this angle. Shank taper angle should not make contact with the work piece.

Total 27 models

Unit (mm)

Model Number	Outside Diameter ϕD	Length of Cut ℓ	Shank Taper Angle B_{ta}	Overall Length L	Shank Diameter ϕd	Number of Flutes	Suggested Retail Price ¥
HMS 3010-0250	1	2.5	16°	45	4	3	7,500
HMS 3010-0350		3.5		45			10,800
HMS 3015-0400		4		45			7,500
HMS 3015-0600	1.5	6	16°	45	4	3	10,800
HMS 3020-0400		4		45			6,700
HMS 3020-0700		7		45			10,000
HMS 3030-0600	3	6	16°	50	6	3	9,240
HMS 3030-1000		10		60			9,800
HMS 3030-1500		15		60			10,920
HMS 4040-0800	4	8	16°	50	6	4	9,870
HMS 4040-1200		12		60			10,470
HMS 4040-2000		20		70			11,450
HMS 4050-1000	5	10	16°	50	6	4	10,500
HMS 4050-1500		15		60			11,100
HMS 4050-2500		25		70			12,180
HMS 6060-1300	6	13	—	50	6	6	11,340
HMS 6060-1800		18		60			12,100
HMS 6060-2600		26		70			13,230
HMS 6080-1900	8	19	—	60	8	6	14,630
HMS 6080-2400		24		70			15,000
HMS 6080-3600		36		90			17,160
HMS 6100-2200	10	22	—	70	10	6	18,360
HMS 6100-3000		30		80			20,000
HMS 6100-4600		46		100			22,990
HMS 6120-2600	12	26	—	75	12	6	24,750
HMS 6120-3600		36		100			25,400
HMS 6120-5600		56		120			28,600

Chip color : Selection example of optimal milling conditions from the viewpoint of cutting heat

SKH51 (63HRC)

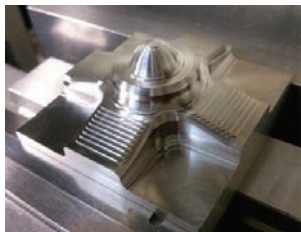

- Work size : 50 × 50 × 30 mm
- Coolant : Air blow (Through spindle)

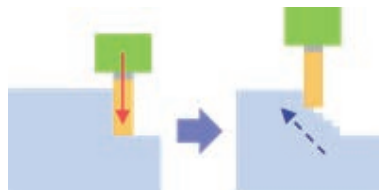

Climb up milling by Square end mills

What is climb up milling?

A milling method that makes effective use of the length of cut to make a large Z-cut in the first shot, and then runs up step by step.

1. Check the chip color under 6 types of conditions

	Spindle Speed (min ⁻¹)	Feed Rate (mm/min)	a_p (mm)	a_e (mm)	Feed per tooth (mm/t)	Chip color	Result	Efficiency (mm ³ /min)
Condition 1	4,000	1,350	10	0.15	0.056	Dark Blue	×	2,025
Condition 2	3,000	1,000	10	0.15	0.056	Red Gold	✓	1,500
Condition 3	2,000	675	10	0.15	0.056	Gold	✓	1,013
Condition 4	2,000	675	20	0.2	0.056	Red Gold	✓	2,700
Condition 5	2,000	1,000	20	0.2	0.083	Red Gold	✓	4,000
Condition 6	2,000	1,000	20	0.4	0.083	Dark Blue	×	8,000

2. Relationship between chip color and cutting heat



3. Optimal cutting condition

Condition 5 is judged to be the optimum condition based on the chip color and processing efficiency. No damage due to chipping of tools after 1 hour roughing process.

Tool after 1 hour roughing process



3 Flutes

4 Flutes

6 Flutes

Ø3mm Shank V Series

UDC-PCD Series

CBN Series

Square

Long Neck Square

Radius

Radius

Taper Neck Radius

Ball

Ball / Long Shank Ball

Long Neck Ball

Taper Neck Ball

Taper

Taper

Barrel

Barrel

Spiral V Cutter

Spiral V Cutter

Drill

Drill

Technical Data

Technical Data

Milling Conditions for HMS

◆Short length of cut

WORK MATERIAL			PREHARDENED STEELS HARDENED STEELS (40~50HRC)					HARDENED STEELS (50~60HRC)					HARDENED STEELS (60HRC~)								
Model Number	Number of Flutes	Outside Diameter (mm)	Spindle Speed (min ⁻¹)	Feed Rate (mm/min)	Slotting		Side Milling		Spindle Speed (min ⁻¹)	Feed Rate (mm/min)	Slotting		Side Milling		Spindle Speed (min ⁻¹)	Feed Rate (mm/min)	Slotting		Side Milling		
					a _p (mm)	a _e (mm)	a _p (mm)	a _e (mm)			a _p (mm)	a _e (mm)	a _p (mm)	a _e (mm)			a _p (mm)	a _e (mm)	a _p (mm)	a _e (mm)	
3010-0250	3	1	9,500	140	0.05	1	0.05	6,400	95	0.05	1	0.05	6,400	90	0.05	1	0.05				
3015-0400		1.5	6,400	100	0.075	1.5	0.075	4,200	60	0.075	1.5	0.075	4,200	60	0.075	1.5	0.075				
3020-0400		2	4,700	80	0.1	2	0.1	3,200	75	0.1	2	0.1	3,200	70	0.1	2	0.1				
3030-0600		3	3,200	85	0.15	3	0.15	2,100	80	0.15	3	0.15	2,100	80	0.15	3	0.15				
4040-0800	4	4	2,400	90	0.2	4	0.2	1,600	85	0.2	4	0.2	1,600	80	0.2	4	0.2				
4050-1000		5	1,900	90	0.25	5	0.25	1,300	85	0.25	5	0.25	1,300	80	0.25	5	0.25				
6060-1300	6	6	1,600	170	0.3	6	0.3	1,100	120	0.3	6	0.3	1,100	110	0.3	6	0.3				
6080-1900		8	1,200	170	0.4	8	0.4	800	120	0.4	8	0.4	800	110	0.4	8	0.4				
6100-2200		10	950	170	0.5	15	0.5	640	100	0.5	15	0.5	640	80	0.5	15	0.5				
6120-2600		12	800	170	0.5	18	0.5	530	90	0.5	18	0.5	530	70	0.5	18	0.5				
Milling Amount (mm)		Slotting	$a_p \leq 0.05D$ (max 0.5 mm)																		
		Side Milling	$D \leq \phi 8$ $a_p = 1D$ $D \geq \phi 10$ $a_p = 1.5D$ $a_e \leq 0.05D$ (max 0.5 mm)																		

◆High speed milling for short length of cut

WORK MATERIAL			PREHARDENED STEELS HARDENED STEELS (40~50HRC)					HARDENED STEELS (50~60HRC)					HARDENED STEELS (60HRC~)				
Model Number	Number of Flutes	Outside Diameter (mm)	Spindle Speed (min ⁻¹)	Feed Rate (mm/min)	Side Milling		Spindle Speed (min ⁻¹)	Feed Rate (mm/min)	Side Milling		Spindle Speed (min ⁻¹)	Feed Rate (mm/min)	Side Milling				
					a _p (mm)	a _e (mm)			a _p (mm)	a _e (mm)			a _p (mm)	a _e (mm)			
3010-0250	3	1	22,500	630	1.5	0.03	20,000	540	1.5	0.02	15,000	450	0.5	0.01			
3015-0400		1.5	18,000	720	2.25	0.045	16,000	630	2.25	0.03	11,500	540	0.75	0.015			
3020-0400		2	14,300	850	3	0.06	13,000	750	3	0.04	8,500	630	1	0.02			
3030-0600		3	13,100	1,120	4.5	0.09	11,200	950	4.5	0.06	6,700	760	1.5	0.03			
4040-0800	4	4	11,300	1,300	6	0.12	9,900	1,170	6	0.08	2,850	630	8	0.08			
4050-1000		5	10,100	1,530	7.5	0.15	8,900	1,350	7.5	0.1	2,400	700	10	0.1			
6060-1300	6	6	8,900	1,950	9	0.18	8,000	1,800	9	0.12	2,150	830	12	0.12			
6080-1900		8	7,700	2,350	12	0.24	6,900	2,200	12	0.16	2,100	900	16	0.16			
6100-2200		10	6,700	3,100	15	0.3	6,000	2,700	15	0.2	2,000	1,000	20	0.2			
6120-2600		12	5,800	3,000	18	0.36	5,300	2,500	18	0.24	1,950	1,070	24	0.24			
Milling Amount (mm)		Side Milling	$a_p = 1.5D$ $a_e = 0.03D$ (max 0.5 mm)					$a_p = 1.5D$ $a_e = 0.02D$					$D \leq \phi 3$ $a_p = 0.5D$ $a_e = 0.01D$ $D \geq \phi 4$ $a_p = 2D$ $a_e = 0.02D$				

Milling Conditions for HMS

◆Medium length of cut

WORK MATERIAL			PREHARDENED STEELS HARDENED STEELS (40~50HRC)					HARDENED STEELS (50~60HRC)					HARDENED STEELS (60HRC~)							
Model Number	Number of Flutes	Outside Diameter (mm)	Spindle Speed (min ⁻¹)	Feed Rate (mm/min)	Slotting		Side Milling		Spindle Speed (min ⁻¹)	Feed Rate (mm/min)	Slotting		Side Milling		Spindle Speed (min ⁻¹)	Feed Rate (mm/min)	Slotting		Side Milling	
					a_p (mm)	a_e (mm)	a_p (mm)	a_e (mm)			a_p (mm)	a_e (mm)	a_p (mm)	a_e (mm)			a_p (mm)	a_e (mm)		
3030-1000	3	3	3,200	43~85	0.09	6	0.09	2,100	40~80	0.09	6	0.09	2,100	40~80	0.09	6	0.09	6	0.09	
4040-1200	4	4	2,400	45~90	0.12	8	0.12	1,600	43~85	0.12	8	0.12	1,600	40~80	0.12	8	0.12	8	0.12	
4050-1500		5	1,900	45~90	0.15	10	0.15	1,300	43~85	0.15	10	0.15	1,300	40~80	0.15	10	0.15	10	0.15	
6060-1800	6	6	1,600	85~170	0.18	12	0.18	1,100	60~120	0.18	12	0.18	1,100	55~110	0.18	12	0.18	12	0.18	
6080-2400		8	1,200	85~170	0.24	16	0.24	800	60~120	0.24	16	0.24	800	55~110	0.24	16	0.24	16	0.24	
6100-3000		10	950	85~170	0.3	25	0.3	640	50~100	0.3	25	0.3	640	40~80	0.3	25	0.3	25	0.3	
6120-3600		12	800	85~170	0.3	30	0.3	530	45~90	0.3	30	0.3	530	35~70	0.3	30	0.3	30	0.3	
Milling Amount (mm)		Slotting	$a_p \leq 0.03D$ (max 0.3 mm)																	
		Side Milling	$D \leq \phi 8 \quad a_p = 2D$ $D \geq \phi 10 \quad a_p = 2.5D$ $a_e \leq 0.03D$ (max 0.3 mm)																	

◆Long length of cut

WORK MATERIAL			PREHARDENED STEELS HARDENED STEELS (40~50HRC)				HARDENED STEELS (50~60HRC)				HARDENED STEELS (60HRC~)			
Model Number	Number of Flutes	Outside Diameter (mm)	Spindle Speed (min ⁻¹)	Feed Rate (mm/min)	Side Milling		Spindle Speed (min ⁻¹)	Feed Rate (mm/min)	Side Milling		Spindle Speed (min ⁻¹)	Feed Rate (mm/min)	Side Milling	
					a_p (mm)	a_e (mm)			a_p (mm)	a_e (mm)			a_p (mm)	a_e (mm)
3010-0350	3	1	9,500	140~210	3	0.02	6,400	95~143	3	0.02	6,400	95~133	3	0.02
3015-0600		1.5	6,300	100~150	4.5	0.03	4,200	80~120	4.5	0.03	4,200	80~112	4.5	0.03
3020-0700		2	4,700	80~120	6	0.04	3,200	75~113	6	0.04	3,200	75~113	6	0.04
3030-1500	4	3	3,200	85~128	9	0.06	2,100	80~120	9	0.06	2,100	80~120	9	0.06
4040-2000		4	2,400	90~135	12	0.08	1,600	85~128	12	0.08	1,600	83~125	12	0.08
4050-2500	6	5	1,900	90~135	15	0.1	1,300	85~128	15	0.1	1,300	83~125	15	0.1
6060-2600		6	1,600	170~255	18	0.12	1,100	120~180	18	0.12	1,100	112~168	18	0.12
6080-3600		8	1,200	170~255	24	0.16	800	120~180	24	0.16	800	110~166	24	0.16
6100-4600		10	950	170~255	30	0.2	640	100~150	30	0.2	640	88~132	30	0.2
6120-5600	12	800	170~255	36	0.24	530	90~135	36	0.24	530	76~114	36	0.24	
Milling Amount (mm)		Side Milling	$a_p = 3D$ $a_e \leq 0.02D$											

Note:

- Recommend down cut processing.
- Reduce cutting amount, feed rate, and apply zero-cut in accordance with required surface quality.
- Recommend air blow or oil mist.

Slotting

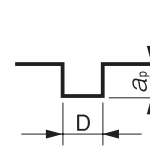

Side Milling

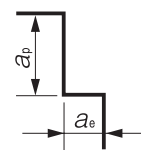

D : Outside Diameter (mm)

3 Flutes

4 Flutes

6 Flutes

Ø3mm Shank
V Series

UDC-PCD
Series

CBN
Series

Square

Square

Long Neck
Square

Radius

Radius

Long Neck
Radius

Taper Neck
Radius

Ball / Long
Shank Ball

Ball

Long Neck
Ball

Taper Neck
Ball

Taper

Barrel

Spiral
V Cutter

Drill

Technical Data



Size $\phi 0.1 \sim \phi 6$

HLS2000



Material Applications (★ Highly Recommended ● Recommended ○ Suggested)

Work Material																	
Carbon Steels S45C S55C	Alloy Steels SK / SCM SUS	Prehardened Steels NAK HPM	Hardened Steels					Cast Iron	Aluminum Alloys	Graphite	Copper	Plastics	Glass Filled Plastics	Titanium Alloys	Heat Resistant Alloys	Cemented Carbide	Hard Brittle (Non-Metallic) Materials
			~50HRC	~55HRC	~60HRC	~65HRC	~70HRC										
○	○	●	●	●	○						○			○	○		

Features

HARDMAX coating and optimized tool design control tool chipping.
Longer tool life with deep rib milling on hard materials.
High Accuracy: Diameter Tolerance: 0/-0.01 ($D \leq 0.15$), 0/-0.015 ($D \geq 0.2$)
Refer to page 288 for 4 flute HLS.

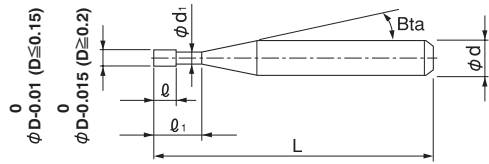

The shank taper angle shown is not an exact value and to avoid contact with the work piece, we recommend the user controls the precise value of this angle. Shank taper angle should not make contact with the work piece.

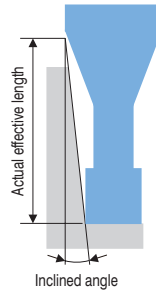

C-CER Cutting edge

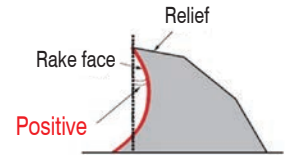

HLS Cutting edge

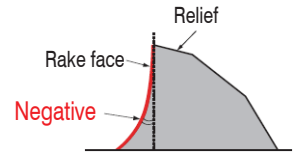

Total 189 models

Unit (mm)

Model Number	Outside Diameter ϕD	Effective Length ℓ_1	Length of Cut ℓ	Neck Diameter ϕd_1	Shank Taper Angle Bta	Overall Length L	Shank Diameter ϕd	Suggested Retail Price ¥	Effective Length by Inclined Angles				
									30'	1°	1° 30'	2°	3°
HLS 2001-003	0.1	0.3	0.1	0.088	11°	45	4	11,160	0.33	0.36	0.38	0.40	0.45
HLS 2001-005		0.5				45	4	12,240	0.54	0.58	0.61	0.64	0.69
HLS 2001-0075		0.75				45	4	13,560	0.80	0.85	0.90	0.95	1.07
HLS 2001-010		1				45	4	15,240	1.07	1.12	1.18	1.25	1.41
HLS 20015-005	0.15	0.5	0.15	0.128	11°	45	4	11,400	0.58	0.61	0.63	0.66	0.71
HLS 20015-0075		0.75				45	4	12,600	0.84	0.88	0.91	0.94	1.02
HLS 20015-010		1				45	4	12,600	1.10	1.14	1.18	1.23	1.32
HLS 2002-005	0.2	0.5	0.3	0.18	16°	45	4	7,320	0.65	0.70	0.74	0.78	0.85
HLS 2002-010		1				45	4	7,920	1.18	1.25	1.31	1.36	1.45
HLS 2002-015		1.5				45	4	9,600	1.67	1.76	1.84	1.90	2.01
HLS 2002-020		2				45	4	10,800	2.23	2.33	2.41	2.49	2.68
HLS 2002-030		3				45	4	11,160	3.27	3.39	3.51	3.63	3.91

Model Number	Outside Diameter ϕD	Effective Length ℓ_1	Length of Cut ℓ	Neck Diameter ϕd_1	Shank Taper Angle Bta	Overall Length L	Shank Diameter ϕd	Suggested Retail Price ¥	Effective Length by Inclined Angles				
									30°	1°	1° 30'	2°	3°
HLS 2003-010	0.3	1	0.4	0.28	16°	45	4	6,480	1.22	1.30	1.37	1.43	1.55
HLS 2003-015		1.5				45	4	6,480	1.71	1.82	1.91	1.98	2.12
HLS 2003-020		2				45	4	7,920	2.24	2.36	2.46	2.55	2.70
HLS 2003-025		2.5				45	4	8,280	2.77	2.91	3.02	3.11	3.27
HLS 2003-030		3				45	4	8,280	3.30	3.45	3.56	3.66	3.83
HLS 2003-040		4				45	4	9,480	4.35	4.51	4.64	4.75	4.94
HLS 2003-060		6				45	4	10,560	6.43	6.63	6.78	6.91	7.12
HLS 2003-090		9				45	4	11,160	9.53	9.76	9.94	10.09	10.32
HLS 2004-015		0.4				1.5	0.6	0.38	16°	45	4	4,680	1.77
HLS 2004-020	2		45	4	4,680	2.31				2.47	2.60	2.71	2.91
HLS 2004-025	2.5		45	4	4,680	2.85				3.02	3.16	3.28	3.49
HLS 2004-030	3		45	4	4,680	3.38				3.57	3.72	3.85	4.07
HLS 2004-035	3.5		45	4	4,680	3.91				4.11	4.27	4.41	4.64
HLS 2004-040	4		45	4	4,680	4.44				4.65	4.82	4.96	5.21
HLS 2004-050	5		45	4	4,680	5.49				5.73	5.91	6.06	6.33
HLS 2004-080	8		45	4	10,200	8.63				8.91	9.13	9.31	9.62
HLS 2004-120	12		45	4	11,160	12.77				13.10	13.36	13.57	13.91
HLS 2005-015	0.5	1.5	0.7	0.48	16°	45	4	3,360	1.83	1.99	2.13	2.25	2.48
HLS 2005-020		2				45	4	3,360	2.37	2.56	2.71	2.85	3.09
HLS 2005-025		2.5				45	4	3,360	2.92	3.12	3.29	3.43	3.69
HLS 2005-030		3				45	4	3,360	3.45	3.68	3.85	4.01	4.28
HLS 2005-040		4				45	4	3,360	4.52	4.77	4.97	5.14	5.44
HLS 2005-050		5				45	4	3,360	5.58	5.86	6.08	6.26	6.58
HLS 2005-060		6				45	4	3,360	6.64	6.94	7.17	7.37	7.71
HLS 2005-080		8				45	4	5,640	8.74	9.07	9.33	9.56	9.93
HLS 2005-100		10				50	4	5,640	10.82	11.19	11.48	11.72	12.12
HLS 2005-150	15	50	4	7,200	16.00	16.44	16.78	17.05	17.50				
HLS 2006-020	0.6	2	0.9	0.58	16°	45	4	3,600	2.39	2.62	2.80	2.96	3.24
HLS 2006-030		3				45	4	3,600	3.49	3.75	3.96	4.14	4.32
HLS 2006-040		4				45	4	3,600	4.57	4.86	5.09	5.29	5.69
HLS 2006-050		5				45	4	3,600	5.64	5.96	6.21	6.43	6.92
HLS 2006-060		6				45	4	3,600	6.70	7.05	7.32	7.57	8.14
HLS 2006-070		7				45	4	4,560	7.76	8.13	8.42	8.71	9.36
HLS 2006-080		8				45	4	5,880	8.81	9.20	9.52	9.85	10.59
HLS 2006-100		10				45	4	6,720	10.91	11.34	11.72	12.13	13.04
HLS 2006-120		12				50	4	7,560	13.00	13.47	13.92	14.40	15.48
HLS 2006-180		18				50	4	9,120	19.23	19.85	20.52	21.24	22.82

3mm Shank
V SeriesUDC-PCD
SeriesCBN
Series

Square

Long Neck
Square

Radius

Long Neck
RadiusTaper Neck
RadiusBall / Long
Shank BallLong Neck
BallTaper Neck
Ball

Taper

Barrel

Spiral
V Cutter

Drill

Technical Data

Model Number	Outside Diameter ϕD	Effective Length ℓ_1	Length of Cut ℓ	Neck Diameter ϕd_1	Shank Taper Angle Bta	Overall Length L	Shank Diameter ϕd	Suggested Retail Price ¥	Effective Length by Inclined Angles				
									30'	1°	1° 30'	2°	3°
HLS 2007-020	0.7	2	1	0.68	16°	45	4	4,080	2.39	2.62	2.80	2.96	3.24
HLS 2007-040		4				45	4	4,080	4.57	4.86	5.09	5.29	5.69
HLS 2007-060		6				45	4	4,080	6.70	7.05	7.32	7.57	8.14
HLS 2007-080		8				45	4	6,600	8.81	9.20	9.52	9.85	10.59
HLS 2007-100		10				50	4	7,520	10.91	11.34	11.72	12.13	13.04
HLS 2008-030	0.8	3	1.2	0.78	16°	45	4	3,960	3.49	3.75	3.96	4.14	4.32
HLS 2008-040		4				45	4	3,960	4.57	4.86	5.09	5.29	5.69
HLS 2008-050		5				45	4	3,960	5.64	5.96	6.21	6.43	6.92
HLS 2008-060		6				45	4	3,960	6.70	7.05	7.32	7.57	8.14
HLS 2008-080		8				45	4	3,960	8.81	9.20	9.52	9.85	10.59
HLS 2008-100		10				50	4	5,880	10.91	11.34	11.72	12.13	13.04
HLS 2008-120		12				50	4	6,600	13.00	13.47	13.92	14.40	15.48
HLS 2008-160		16				50	4	7,560	17.16	17.73	18.32	18.96	20.38
HLS 2008-240		24				60	4	9,240	25.42	26.24	27.13	28.07	30.17
HLS 2009-040		0.9				4	1.3	0.88	16°	45	4	4,560	4.57
HLS 2009-060	6		45	4	4,560	6.70				7.05	7.32	7.57	8.14
HLS 2009-080	8		45	4	4,560	8.81				9.20	9.52	9.85	10.59
HLS 2009-100	10		45	4	4,560	10.91				11.34	11.72	12.13	13.04
HLS 2009-150	15		50	4	6,790	16.12				16.66	17.22	17.82	19.15
HLS 2010-030	1	3	1.5	0.95	16°	45	4	3,600	3.62	3.85	4.04	4.21	4.54
HLS 2010-040		4				45	4	3,600	4.69	4.95	5.16	5.36	5.76
HLS 2010-050		5				45	4	3,600	5.75	6.04	6.27	6.49	6.98
HLS 2010-060		6				45	4	3,600	6.80	7.12	7.38	7.63	8.21
HLS 2010-070		7				45	4	3,600	7.85	8.19	8.48	8.77	9.43
HLS 2010-080		8				45	4	3,600	8.90	9.26	9.58	9.91	10.65
HLS 2010-090		9				45	4	3,600	9.95	10.33	10.68	11.05	11.88
HLS 2010-100		10				45	4	3,600	10.99	11.39	11.78	12.19	13.10
HLS 2010-120		12				45	4	3,600	13.07	13.52	13.98	14.47	15.55
HLS 2010-140		14				45	4	3,600	15.15	15.65	16.18	16.74	18.00
HLS 2010-160		16				50	4	5,880	17.22	17.78	18.38	19.02	20.44
HLS 2010-180		18				55	4	5,880	19.29	19.92	20.59	21.30	22.90
HLS 2010-200		20				55	4	5,880	21.35	22.04	22.78	23.57	25.34
HLS 2010-250		25				70	4	6,720	26.51	27.37	28.29	29.27	No Interference
HLS 2010-300		30				70	4	7,560	31.66	32.69	33.79	34.96	No Interference

- 3mm Shank V Series
- UDC-PCD Series
- CBN Series
- Square
- Long Neck Square
- Radius
- Long Neck Radius
- Taper Neck Radius
- Ball / Long Shank Ball
- Long Neck Ball
- Taper Neck Ball
- Taper
- Barrel
- Spiral V Cutter
- Drill
- Technical Data

Model Number	Outside Diameter ϕD	Effective Length ℓ_1	Length of Cut ℓ	Neck Diameter ϕd_1	Shank Taper Angle β	Overall Length L	Shank Diameter ϕd	Suggested Retail Price ¥	Effective Length by Inclined Angles				
									30'	1°	1° 30'	2°	3°
HLS 2012-040	1.2	4	1.8	1.14	16°	45	4	3,840	4.13	4.27	4.41	4.57	4.91
HLS 2012-060		6				45	4	3,840	6.19	6.40	6.61	6.84	7.36
HLS 2012-080		8				45	4	3,840	8.26	8.52	8.81	9.12	9.80
HLS 2012-100		10				45	4	3,840	10.32	10.65	11.01	11.40	12.25
HLS 2012-120		12				45	4	3,840	12.38	12.78	13.21	13.67	14.70
HLS 2012-160		16				50	4	6,000	16.51	17.04	17.62	18.23	19.59
HLS 2012-200		20				60	4	6,000	20.63	21.30	22.02	22.78	24.49
HLS 2014-060	1.4	6	2.1	1.34	16°	45	4	3,960	6.19	6.40	6.61	6.84	7.36
HLS 2014-080		8				45	4	3,960	8.26	8.52	8.81	9.12	9.80
HLS 2014-100		10				45	4	3,960	10.32	10.65	11.01	11.40	12.25
HLS 2014-120		12				45	4	3,960	12.38	12.78	13.21	13.67	14.70
HLS 2014-140		14				45	4	3,960	14.44	14.91	15.42	15.95	17.15
HLS 2014-160		16				50	4	4,560	16.51	17.04	17.62	18.23	19.59
HLS 2014-220		22				55	4	6,120	22.69	23.43	24.22	25.06	No Interference
HLS 2015-040	1.5	4	2.3	1.44	16°	45	4	3,840	4.13	4.27	4.41	4.57	4.91
HLS 2015-060		6				45	4	3,840	6.19	6.40	6.61	6.84	7.36
HLS 2015-080		8				45	4	3,840	8.26	8.52	8.81	9.12	9.80
HLS 2015-100		10				45	4	3,840	10.32	10.65	11.01	11.40	12.25
HLS 2015-120		12				45	4	3,840	12.38	12.78	13.21	13.67	14.70
HLS 2015-140		14				50	4	3,960	14.44	14.91	15.42	15.95	17.15
HLS 2015-160		16				50	4	3,960	16.51	17.04	17.62	18.23	19.59
HLS 2015-180		18				55	4	3,960	18.57	19.17	19.82	20.51	22.04
HLS 2015-200		20				55	4	3,960	20.63	21.30	22.02	22.78	No Interference
HLS 2015-250		25				70	4	5,880	25.79	26.63	27.52	28.48	No Interference
HLS 2015-300		30				70	4	5,880	30.95	31.95	33.02	34.17	No Interference
HLS 2015-350		35				70	4	6,600	36.10	37.27	38.53	No Interference	No Interference
HLS 2015-400		40				80	4	7,440	41.26	42.60	44.03	No Interference	No Interference
HLS 2015-450		45				80	4	7,440	46.42	47.92	No Interference	No Interference	No Interference
HLS 2016-060		1.6				6	2.4	1.51	16°	45	4	3,960	6.23
HLS 2016-080	8		45	4	3,960	8.29				8.56	8.85	9.16	9.85
HLS 2016-100	10		45	4	3,960	10.35				10.69	11.05	11.43	12.29
HLS 2016-120	12		45	4	3,960	12.42				12.82	13.25	13.71	14.74
HLS 2016-140	14		50	4	3,960	14.48				14.95	15.45	15.99	17.19
HLS 2016-160	16		50	4	3,960	16.54				17.08	17.65	18.27	19.63
HLS 2016-180	18		55	4	3,960	18.60				19.21	19.85	20.54	22.08
HLS 2016-200	20		55	4	3,960	20.67				21.34	22.05	22.82	No Interference
HLS 2016-260	26		60	4	6,120	26.85				27.73	28.66	29.65	No Interference

3mm Shank V Series

UDC-PCD Series

CBN Series

Square
Long Neck SquareRadius
Long Neck Radius

Taper Neck Radius

Ball / Long Shank Ball

Long Neck Ball

Taper Neck Ball

Taper

Barrel

Spiral V Cutter

Drill

Technical Data

Model Number	Outside Diameter ϕD	Effective Length ℓ_1	Length of Cut ℓ	Neck Diameter ϕd_1	Shank Taper Angle Bta	Overall Length L	Shank Diameter ϕd	Suggested Retail Price ¥	Effective Length by Inclined Angles								
									30'	1°	1° 30'	2°	3°				
HLS 2018-060	1.8	6	2.7	1.71	16°	45	4	3,960	6.23	6.43	6.65	6.88	7.40				
HLS 2018-080		8				45	4	3,960	8.29	8.56	8.85	9.16	9.85				
HLS 2018-100		10				45	4	3,960	10.35	10.69	11.05	11.43	12.29				
HLS 2018-120		12				45	4	3,960	12.42	12.82	13.25	13.71	14.74				
HLS 2018-140		14				50	4	3,960	14.48	14.95	15.45	15.99	17.19				
HLS 2018-160		16				50	4	3,960	16.54	17.08	17.65	18.27	19.63				
HLS 2018-180		18				55	4	3,960	18.60	19.21	19.85	20.54	No Interference				
HLS 2018-200		20				55	4	3,960	20.67	21.34	22.05	22.82	No Interference				
HLS 2018-250		25				60	4	5,520	25.82	26.66	27.56	28.52	No Interference				
HLS 2020-060		2				6	3	1.91	16°	45	4	3,840	6.23	6.43	6.65	6.88	7.40
HLS 2020-080	8		45	4	3,840	8.29				8.56	8.85	9.16	9.85				
HLS 2020-100	10		45	4	3,840	10.35				10.69	11.05	11.44	12.29				
HLS 2020-120	12		45	4	3,840	12.42				12.82	13.25	13.71	14.74				
HLS 2020-140	14		50	4	3,840	14.48				14.95	15.45	15.99	17.19				
HLS 2020-160	16		50	4	3,840	16.54				17.08	17.65	18.27	No Interference				
HLS 2020-180	18		55	4	3,840	18.61				19.21	19.86	20.55	No Interference				
HLS 2020-200	20		55	4	3,840	20.67				21.34	22.05	22.82	No Interference				
HLS 2020-250	25		60	4	3,840	25.83				26.66	27.56	28.52	No Interference				
HLS 2020-300	30		70	4	4,680	30.98				31.99	33.06	No Interference	No Interference				
HLS 2020-350	35		80	4	5,640	36.14				37.31	38.56	No Interference	No Interference				
HLS 2020-400	40		90	4	7,080	41.30				42.64	No Interference	No Interference	No Interference				
HLS 2020-500	50		100	4	8,520	51.61				53.28	No Interference	No Interference	No Interference				
HLS 2020-600	60		110	4	10,200	61.92				No Interference	No Interference	No Interference	No Interference				
HLS 2025-080	2.5		8	3.7	2.41	16°				45	4	3,960	8.29	8.56	8.85	9.16	9.85
HLS 2025-100			10							45	4	3,960	10.35	10.69	11.05	11.44	12.29
HLS 2025-120			12							45	4	3,960	12.42	12.82	13.25	13.71	No Interference
HLS 2025-140			14							50	4	3,960	14.48	14.95	15.45	15.99	No Interference
HLS 2025-160			16							50	4	3,960	16.54	17.08	17.65	18.27	No Interference
HLS 2025-180			18							55	4	3,960	18.61	19.21	19.86	20.55	No Interference
HLS 2025-200		20	55				4	3,960	20.67	21.34	22.06	No Interference	No Interference				
HLS 2025-250		25	60				4	4,320	25.83	26.66	27.56	No Interference	No Interference				
HLS 2025-300		30	70				4	4,320	30.98	31.99	No Interference	No Interference	No Interference				
HLS 2025-400		40	90				4	6,000	41.30	42.64	No Interference	No Interference	No Interference				
HLS 2025-500		50	100				4	7,440	51.61	No Interference	No Interference	No Interference	No Interference				

- $\phi 3\text{mm}$ Shank V Series
- UDC-PCD Series
- CBN Series
- Square
- Long Neck Square
- Radius
- Long Neck Radius
- Taper Neck Radius
- Ball / Long Shank Ball
- Long Neck Ball
- Taper Neck Ball
- Taper
- Barrel
- Spiral V Cutter
- Drill
- Technical Data

Model Number	Outside Diameter ϕD	Effective Length ℓ_1	Length of Cut ℓ	Neck Diameter ϕd_1	Shank Taper Angle Bta	Overall Length L	Shank Diameter ϕd	Suggested Retail Price ¥	Effective Length by Inclined Angles				
									30'	1°	1° 30'	2°	3°
HLS 2030-080	3	8	4.5	2.92	16°	45	6	5,160	8.29	8.56	8.85	9.16	9.84
HLS 2030-100		10				45	6	5,160	10.35	10.69	11.05	11.43	12.29
HLS 2030-120		12				50	6	5,160	12.41	12.82	13.25	13.71	14.74
HLS 2030-140		14				50	6	5,160	14.48	14.95	15.45	15.99	17.18
HLS 2030-160		16				60	6	5,160	16.54	17.08	17.65	18.26	19.63
HLS 2030-180		18				60	6	5,160	18.60	19.21	19.85	20.54	22.08
HLS 2030-200		20				60	6	5,160	20.66	21.34	22.05	22.82	24.53
HLS 2030-250		25				70	6	5,160	25.82	26.66	27.56	28.51	No Interference
HLS 2030-300		30				80	6	6,120	30.98	31.98	33.06	34.21	No Interference
HLS 2030-350		35				80	6	6,360	36.14	37.31	38.56	39.90	No Interference
HLS 2030-400		40				90	6	6,360	41.29	42.63	44.06	No Interference	No Interference
HLS 2030-500		50				100	6	8,880	51.61	53.28	55.07	No Interference	No Interference
HLS 2040-120	4	12	6	3.82	16°	50	6	5,880	12.59	13.00	13.44	13.91	14.95
HLS 2040-160		16				60	6	5,880	16.72	17.26	17.84	18.46	No Interference
HLS 2040-200		20				60	6	5,880	20.84	21.52	22.24	23.02	No Interference
HLS 2040-250		25				70	6	5,880	26.00	26.85	27.75	28.71	No Interference
HLS 2040-300		30				70	6	5,880	31.16	32.17	33.25	No Interference	No Interference
HLS 2040-350		35				80	6	5,880	36.32	37.49	38.75	No Interference	No Interference
HLS 2040-400		40				90	6	7,440	41.47	42.82	No Interference	No Interference	No Interference
HLS 2040-450		45				90	6	9,000	46.63	48.14	No Interference	No Interference	No Interference
HLS 2040-500		50				100	6	11,040	51.79	53.47	No Interference	No Interference	No Interference
HLS 2040-600		60				110	6	13,680	62.10	No Interference	No Interference	No Interference	No Interference
HLS 2050-160	5	16	7.5	4.82	16°	60	6	7,440	16.72	17.26	17.84	No Interference	No Interference
HLS 2050-200		20				60	6	7,440	20.84	21.52	No Interference	No Interference	No Interference
HLS 2050-250		25				60	6	7,440	26.00	26.85	No Interference	No Interference	No Interference
HLS 2050-300		30				80	6	7,440	31.16	No Interference	No Interference	No Interference	No Interference
HLS 2050-350		35				80	6	7,440	36.32	No Interference	No Interference	No Interference	No Interference
HLS 2050-400		40				80	6	7,440	41.47	No Interference	No Interference	No Interference	No Interference
HLS 2050-500		50				110	6	11,760	51.79	No Interference	No Interference	No Interference	No Interference
HLS 2050-600		60				120	6	14,400	No Interference	No Interference	No Interference	No Interference	No Interference
HLS 2060-200	6	20	9	5.82	—	80	6	7,680	No Interference	No Interference	No Interference	No Interference	No Interference
HLS 2060-300		30				80	6	7,920	No Interference	No Interference	No Interference	No Interference	No Interference
HLS 2060-400		40				100	6	9,240	No Interference	No Interference	No Interference	No Interference	No Interference
HLS 2060-500		50				120	6	11,760	No Interference	No Interference	No Interference	No Interference	No Interference
HLS 2060-600		60				120	6	15,000	No Interference	No Interference	No Interference	No Interference	No Interference

ø3mm Shank
V SeriesUDC-PCD
SeriesCBN
SeriesSquare
Long Neck
SquareRadius
Long Neck
RadiusTaper Neck
RadiusBall / Long
Shank BallLong Neck
BallTaper Neck
Ball

Taper

Barrel

Spiral
V Cutter

Drill

Technical Data

Milling Conditions for HLS (2 Flutes)

WORK MATERIAL			CARBON STEELS S45C / S50C (~225HB)				ALLOY STEELS SK / SCM / SUS (225~325HB)				PREHARDENED STEELS HARDENED STEELS NAK / SKD(30~45HRC)			
Model Number	Outside Diameter (mm)	Effective Length (mm)	Spindle Speed (min ⁻¹)	Feed Rate (mm/min)	a _p Axial Depth (mm)	a _e Radial Depth (mm)	Spindle Speed (min ⁻¹)	Feed Rate (mm/min)	a _p Axial Depth (mm)	a _e Radial Depth (mm)	Spindle Speed (min ⁻¹)	Feed Rate (mm/min)	a _p Axial Depth (mm)	a _e Radial Depth (mm)
2001	0.1	0.3	30,000	30	0.003~0.005	0.035	30,000	15	0.002~0.005	0.035	30,000	16	0.001~0.004	0.035
		0.5	28,000	28	0.002~0.005	0.03	28,000	14	0.002~0.004	0.03	28,000	14	0.001~0.003	0.03
		0.75	26,000	26	0.002~0.003	0.01	26,000	13	0.001~0.002	0.01	26,000	13	0.001~0.002	0.01
		1	24,000	24	0.002~0.003	0.005	24,000	12	0.001~0.002	0.005	24,000	12	0.001~0.002	0.005
20015	0.15	0.5	30,000	90	0.004~0.007	0.07	30,000	80	0.003~0.006	0.07	30,000	70	0.003~0.005	0.07
		0.75	28,700	90	0.003~0.007	0.032	28,700	80	0.002~0.006	0.032	28,700	70	0.002~0.005	0.032
		1	27,300	80	0.002~0.006	0.015	27,300	70	0.001~0.005	0.015	27,300	60	0.001~0.004	0.015
2002	0.2	0.5	56,000	340	0.005~0.009	0.13	56,000	310	0.005~0.008	0.13	56,000	270	0.004~0.006	0.13
		1	50,900	290	0.003~0.007	0.035	50,900	260	0.003~0.006	0.035	50,900	230	0.002~0.004	0.035
		1.5	48,200	250	0.003~0.004	0.012	48,200	230	0.002~0.003	0.012	48,200	200	0.001~0.002	0.012
		2	43,500	190	0.001~0.002	0.003	43,500	170	0.001~0.002	0.003	43,500	150	0.001~0.002	0.003
		3	41,300	160	0.001~0.001	0.002	41,300	145	0.001~0.001	0.002	41,300	130	0.001~0.001	0.002
2003	0.3	1	60,000	560	0.009~0.015	0.101	60,000	500	0.008~0.013	0.101	60,000	440	0.006~0.01	0.101
		1.5	50,800	460	0.008~0.013	0.05	50,800	410	0.007~0.011	0.05	50,800	360	0.005~0.009	0.05
		2	41,500	350	0.006~0.01	0.023	41,500	320	0.005~0.009	0.023	41,500	280	0.004~0.007	0.023
		2.5	36,700	300	0.004~0.005	0.012	36,700	270	0.004~0.006	0.012	36,700	240	0.003~0.005	0.012
		3	31,900	240	0.002~0.004	0.008	31,900	220	0.002~0.003	0.008	31,900	190	0.001~0.002	0.008
		4	26,200	170	0.001~0.002	0.003	26,200	160	0.001~0.002	0.003	26,200	140	0.001~0.001	0.003
		6	20,400	100	0.001~0.001	—	20,400	90	0.001~0.001	—	20,400	80	0.001~0.001	—
		9	15,700	30	0.001~0.001	—	15,700	30	0.001~0.001	—	15,700	30	0.001~0.001	—
2004	0.4	1.5	52,700	660	0.011~0.016	0.095	57,700	640	0.009~0.015	0.095	48,100	470	0.007~0.012	0.095
		2	50,000	610	0.009~0.014	0.052	53,000	580	0.008~0.013	0.052	44,600	430	0.006~0.01	0.052
		2.5	47,300	560	0.007~0.012	0.026	48,300	520	0.007~0.011	0.026	41,100	390	0.005~0.008	0.026
		3	44,500	510	0.005~0.009	0.018	43,600	450	0.005~0.008	0.018	37,500	340	0.004~0.006	0.018
		3.5	42,800	480	0.005~0.008	0.01	40,800	410	0.004~0.009	0.01	35,300	310	0.004~0.005	0.01
		4	41,000	440	0.004~0.006	0.008	38,000	360	0.003~0.005	0.008	33,100	280	0.003~0.004	0.008
		5	38,500	380	0.003~0.004	0.004	34,200	300	0.002~0.004	0.004	30,100	240	0.002~0.003	0.004
		8	33,700	260	0.001~0.002	0.001	27,300	190	0.001~0.002	0.001	24,600	150	0.001~0.002	0.001
		12	30,000	140	0.001~0.001	—	22,500	100	0.001~0.001	—	20,700	80	0.001~0.001	—
2005	0.5	1.5	63,100	1,020	0.019~0.029	0.139	61,000	870	0.017~0.027	0.139	46,500	610	0.013~0.02	0.139
		2	56,800	900	0.015~0.025	0.098	54,000	760	0.014~0.023	0.098	40,600	510	0.011~0.018	0.098
		2.5	50,500	780	0.011~0.021	0.057	47,000	650	0.011~0.019	0.057	34,700	410	0.009~0.016	0.057
		3	44,200	660	0.007~0.016	0.037	39,900	530	0.008~0.015	0.037	32,200	370	0.007~0.011	0.037
		4	40,600	580	0.008~0.013	0.016	36,100	460	0.007~0.012	0.016	29,700	330	0.006~0.009	0.016
		5	37,000	500	0.006~0.01	0.008	32,300	390	0.006~0.009	0.008	27,200	290	0.005~0.007	0.008
		6	33,400	420	0.004~0.007	0.005	28,500	320	0.004~0.006	0.005	24,700	250	0.003~0.005	0.005
		8	29,100	320	0.002~0.003	0.002	24,100	240	0.002~0.003	0.002	21,600	190	0.001~0.003	0.002
		10	26,100	250	0.001~0.002	0.001	21,200	180	0.001~0.002	0.001	19,600	150	0.001~0.002	0.001
		15	21,500	120	0.001~0.001	—	16,700	80	0.001~0.001	—	16,300	70	0.001~0.001	—
2006	0.6	2	63,600	1,240	0.023~0.038	0.18	53,300	930	0.02~0.034	0.18	39,100	600	0.016~0.026	0.18
		3	52,500	990	0.018~0.03	0.075	44,000	740	0.016~0.026	0.075	33,500	500	0.013~0.02	0.075
		4	41,300	740	0.012~0.021	0.03	34,700	550	0.011~0.018	0.03	27,900	390	0.009~0.014	0.03
		5	36,700	630	0.01~0.017	0.017	30,900	470	0.009~0.014	0.017	25,500	340	0.007~0.011	0.017
		6	32,100	520	0.007~0.012	0.01	27,000	390	0.006~0.01	0.01	23,000	290	0.005~0.008	0.01
		7	29,500	460	0.006~0.01	0.005	24,800	350	0.005~0.008	0.005	21,500	260	0.004~0.006	0.005
		8	26,800	390	0.004~0.007	0.004	22,600	300	0.004~0.006	0.004	20,000	230	0.003~0.005	0.004
		10	23,400	300	0.002~0.004	0.002	19,700	230	0.002~0.004	0.002	17,900	180	0.002~0.003	0.002
		12	20,900	240	0.002~0.003	0.001	17,600	180	0.002~0.002	0.001	16,400	150	0.001~0.002	0.001
18	16,200	100	0.001~0.001	—	13,700	80	0.001~0.001	—	13,500	70	0.001~0.001	—		

- φ3mm Shank V Series
- UDC-PCD Series
- CBN Series
- Square
- Long Neck Square
- Radius
- Long Neck Radius
- Taper Neck Radius
- Ball / Long Shank Ball
- Long Neck Ball
- Taper Neck Ball
- Taper
- Barrel
- Spiral V Cutter
- Drill
- Technical Data

Milling Conditions for HLS (2 Flutes)

WORK MATERIAL			HARDENED STEELS SKD / SKT (45~55HRC)				HARDENED STEELS SKD / SKH (55~60HRC)			
Model Number	Outside Diameter (mm)	Effective Length (mm)	Spindle Speed (min ⁻¹)	Feed Rate (mm/min)	a _p Axial Depth (mm)	a _e Radial Depth (mm)	Spindle Speed (min ⁻¹)	Feed Rate (mm/min)	a _p Axial Depth (mm)	a _e Radial Depth (mm)
2001	0.1	0.3	—	—	— ~ —	0.035	—	—	— ~ —	0.035
		0.5	—	—	— ~ —	0.03	—	—	— ~ —	0.03
		0.75	—	—	— ~ —	—	—	—	— ~ —	—
		1	—	—	— ~ —	—	—	—	— ~ —	—
20015	0.15	0.5	30,000	50	0.003~0.004	0.07	—	—	— ~ —	0.07
		0.75	28,700	50	0.002~0.004	0.032	—	—	— ~ —	0.032
		1	27,300	40	0.001~0.003	0.015	—	—	— ~ —	0.015
2002	0.2	0.5	44,800	180	0.003~0.004	0.13	15,000	10	0.001~0.002	0.13
		1	40,800	160	0.001~0.002	0.035	—	—	— ~ —	0.035
		1.5	38,500	140	0.001~0.001	0.012	—	—	— ~ —	0.012
		2	34,500	100	0.001~0.001	0.003	—	—	— ~ —	—
		3	32,600	80	0.001~0.001	0.002	—	—	— ~ —	—
2003	0.3	1	52,100	330	0.004~0.007	0.101	14,600	14	0.003~0.004	0.101
		1.5	42,700	260	0.004~0.006	0.05	14,600	13	0.003~0.004	0.05
		2	33,200	190	0.003~0.005	0.023	14,600	12	0.002~0.003	0.023
		2.5	29,400	160	0.002~0.004	0.012	14,600	11	0.001~0.002	0.012
		3	25,500	130	0.001~0.002	0.008	14,600	10	0.001~0.001	0.008
		4	20,900	100	0.001~0.001	0.003	14,600	9	0.001~0.001	0.003
		6	16,300	60	0.001~0.001	—	—	—	— ~ —	—
2004	0.4	1.5	38,500	320	0.004~0.008	0.095	14,300	17	0.003~0.004	0.095
		2	35,700	290	0.004~0.007	0.052	14,300	17	0.003~0.004	0.052
		2.5	32,900	260	0.004~0.006	0.026	14,300	17	0.003~0.004	0.026
		3	30,000	230	0.003~0.005	0.018	14,300	16	0.002~0.003	0.018
		3.5	28,300	210	0.003~0.004	0.01	14,300	16	0.002~0.003	0.01
		4	26,500	190	0.002~0.003	0.008	14,300	15	0.001~0.002	0.008
		5	24,100	160	0.001~0.002	0.004	14,300	14	0.001~0.001	0.004
		8	19,700	100	0.001~0.001	0.001	14,300	11	0.001~0.001	0.001
		12	16,500	60	0.001~0.001	—	—	—	— ~ —	—
2005	0.5	1.5	37,300	410	0.009~0.015	0.139	14,000	20	0.004~0.008	0.139
		2	32,500	350	0.008~0.013	0.098	14,000	20	0.004~0.007	0.098
		2.5	27,700	290	0.007~0.011	0.057	14,000	20	0.004~0.006	0.057
		3	25,700	260	0.005~0.009	0.037	14,000	19	0.004~0.005	0.037
		4	23,700	230	0.004~0.007	0.016	14,000	18	0.003~0.004	0.016
		5	21,700	200	0.003~0.005	0.008	14,000	17	0.002~0.003	0.008
		6	19,700	170	0.002~0.003	0.005	14,000	16	0.001~0.002	0.005
		8	17,300	130	0.001~0.002	0.002	14,000	14	0.001~0.001	0.002
		10	15,600	100	0.001~0.001	0.001	14,000	12	0.001~0.001	0.001
2006	0.6	15	13,000	50	0.001~0.001	—	—	—	— ~ —	—
		2	31,300	410	0.011~0.019	0.18	12,000	23	0.006~0.01	0.18
		3	26,800	340	0.009~0.015	0.075	12,000	22	0.005~0.008	0.075
		4	22,300	270	0.006~0.01	0.03	12,000	21	0.003~0.005	0.03
		5	20,400	240	0.005~0.008	0.017	12,000	20	0.003~0.004	0.017
		6	18,400	200	0.003~0.006	0.01	12,000	19	0.002~0.003	0.01
		7	17,200	180	0.003~0.005	0.005	12,000	18	0.002~0.003	0.005
		8	16,000	160	0.002~0.003	0.004	12,000	17	0.001~0.002	0.004
		10	14,300	130	0.001~0.002	0.002	12,000	15	0.001~0.001	0.002
		12	13,100	100	0.001~0.001	0.001	12,000	13	0.001~0.001	0.001
18	10,800	50	0.001~0.001	—	—	—	— ~ —	—		

φ3mm Shank
V Series

UDC-PCD
Series

CBN
Series

Square

Square
Long Neck
Square

Radius

Radius
Long Neck
Radius
Taper Neck
Radius

Ball

Ball / Long
Shank Ball
Long Neck
Ball
Taper Neck
Ball

Taper

Taper

Barrel

Spiral
V Cutter

Drill

Technical Data

Milling Conditions for HLS (2 Flutes)

WORK MATERIAL			CARBON STEELS S45C / S50C (~225HB)				ALLOY STEELS SK / SCM / SUS (225~325HB)				PREHARDENED STEELS HARDENED STEELS NAK / SKD(30~45HRC)			
Model Number	Outside Diameter (mm)	Effective Length (mm)	Spindle Speed (min ⁻¹)	Feed Rate (mm/min)	a _p Axial Depth (mm)	a _e Radial Depth (mm)	Spindle Speed (min ⁻¹)	Feed Rate (mm/min)	a _p Axial Depth (mm)	a _e Radial Depth (mm)	Spindle Speed (min ⁻¹)	Feed Rate (mm/min)	a _p Axial Depth (mm)	a _e Radial Depth (mm)
2007	0.7	2	59,800	1,380	0.03 ~0.05	0.165	50,200	1,040	0.027~0.045	0.165	36,100	660	0.021~0.035	0.165
		4	38,900	840	0.017~0.029	0.047	32,700	630	0.015~0.026	0.047	25,800	440	0.012~0.02	0.047
		6	30,200	600	0.01 ~0.017	0.014	25,400	450	0.009~0.015	0.014	21,200	330	0.007~0.012	0.014
		8	25,300	460	0.006~0.01	0.006	21,300	350	0.005~0.009	0.006	18,400	260	0.004~0.007	0.006
		10	22,000	360	0.004~0.006	0.004	18,500	270	0.003~0.005	0.004	16,500	220	0.003~0.005	0.004
2008	0.8	3	41,200	1,050	0.033~0.053	0.15	34,500	790	0.029~0.049	0.15	26,200	530	0.023~0.038	0.15
		4	37,100	930	0.027~0.044	0.08	31,100	700	0.024~0.04	0.08	24,100	480	0.019~0.031	0.08
		5	33,000	810	0.021~0.035	0.052	27,700	610	0.019~0.031	0.052	22,000	430	0.015~0.024	0.052
		6	28,800	680	0.015~0.025	0.024	24,200	510	0.013~0.022	0.024	19,800	370	0.01 ~0.017	0.024
		8	24,100	520	0.009~0.015	0.01	20,300	390	0.008~0.013	0.01	17,200	300	0.006~0.01	0.01
		10	21,000	420	0.006~0.009	0.005	17,700	320	0.005~0.008	0.005	15,500	240	0.004~0.007	0.005
		12	18,700	340	0.004~0.006	0.003	15,800	260	0.003~0.006	0.003	14,100	200	0.003~0.004	0.003
		16	15,600	230	0.002~0.003	0.001	13,200	180	0.002~0.003	0.001	12,300	150	0.002~0.002	0.001
2009	0.9	4	35,600	1,100	0.033~0.054	0.128	29,500	820	0.029~0.049	0.128	22,500	550	0.023~0.038	0.128
		6	27,600	790	0.019~0.032	0.038	23,000	590	0.017~0.029	0.038	18,500	420	0.013~0.022	0.038
		8	23,000	600	0.012~0.02	0.016	19,300	450	0.011~0.018	0.016	16,100	330	0.008~0.014	0.016
		10	20,000	470	0.008~0.013	0.008	16,800	360	0.007~0.012	0.008	14,500	270	0.005~0.009	0.008
		15	15,500	270	0.003~0.006	0.002	13,100	200	0.003~0.005	0.002	11,900	160	0.002~0.004	0.002
2010	1	3	37,900	1,340	0.048~0.067	0.263	31,500	990	0.043~0.072	0.263	23,400	650	0.034~0.057	0.263
		4	34,100	1,170	0.04 ~0.067	0.195	28,400	870	0.036~0.06	0.195	21,500	580	0.028~0.047	0.195
		5	30,300	1,000	0.032~0.053	0.127	25,300	750	0.029~0.048	0.127	19,600	510	0.022~0.037	0.127
		6	26,500	850	0.023~0.039	0.058	22,100	630	0.021~0.035	0.058	17,600	440	0.016~0.027	0.058
		7	24,300	760	0.019~0.032	0.041	20,400	560	0.017~0.029	0.041	16,500	400	0.013~0.022	0.041
		8	22,100	660	0.014~0.024	0.024	18,600	490	0.013~0.022	0.024	15,300	360	0.01 ~0.017	0.024
		9	20,700	600	0.012~0.02	0.019	17,400	450	0.011~0.018	0.019	14,600	330	0.009~0.014	0.019
		10	19,200	530	0.01 ~0.016	0.013	16,200	400	0.009~0.014	0.013	13,800	300	0.007~0.011	0.013
		12	17,200	440	0.007~0.011	0.007	14,500	330	0.006~0.01	0.007	12,600	250	0.005~0.008	0.007
		14	15,600	360	0.005~0.008	0.005	13,200	270	0.004~0.007	0.005	11,700	210	0.003~0.006	0.005
		16	14,300	300	0.004~0.006	0.003	12,100	230	0.003~0.006	0.003	11,000	180	0.003~0.005	0.003
		18	13,400	250	0.003~0.005	0.002	11,350	190	0.002~0.004	0.002	10,400	150	0.002~0.004	0.002
		20	12,500	200	0.002~0.004	0.002	10,600	160	0.002~0.003	0.002	9,800	130	0.002~0.003	0.002
2012	1.2	30	10,800	120	0.002~0.003	0.001	9,200	100	0.001~0.002	0.001	8,800	80	0.001~0.002	0.001
		4	9,700	80	0.001~0.002	—	8,200	60	0.001~0.002	—	8,100	50	0.001~0.002	—
		4	28,900	1,180	0.05 ~0.085	0.23	24,100	870	0.047~0.077	0.23	18,300	580	0.036~0.059	0.23
		6	24,800	970	0.037~0.062	0.12	20,700	720	0.034~0.056	0.12	16,100	490	0.026~0.043	0.12
		8	20,700	760	0.024~0.039	0.051	17,300	570	0.021~0.035	0.051	13,900	400	0.016~0.027	0.051
		10	18,000	620	0.016~0.026	0.026	15,100	470	0.014~0.023	0.026	12,400	340	0.011~0.018	0.026
		12	16,100	520	0.011~0.018	0.015	13,500	390	0.01 ~0.016	0.015	11,400	290	0.008~0.013	0.015
		16	13,400	380	0.006~0.01	0.006	11,300	290	0.005~0.009	0.006	9,800	220	0.004~0.007	0.006
2014	1.4	20	11,700	280	0.004~0.007	0.003	9,900	210	0.004~0.006	0.003	8,800	170	0.003~0.005	0.003
		6	23,300	1,070	0.052~0.086	0.222	19,400	800	0.047~0.078	0.222	14,800	540	0.036~0.061	0.222
		8	19,500	850	0.035~0.059	0.094	16,300	640	0.032~0.053	0.094	12,900	440	0.025~0.041	0.094
		10	16,900	710	0.025~0.041	0.048	14,200	530	0.022~0.037	0.048	11,500	380	0.017~0.029	0.048
		12	15,100	600	0.018~0.03	0.028	12,700	450	0.016~0.027	0.028	10,500	330	0.013~0.021	0.028
		14	13,700	510	0.013~0.022	0.018	11,500	390	0.012~0.02	0.018	9,700	290	0.009~0.016	0.018
		16	12,600	450	0.01 ~0.017	0.012	10,600	340	0.009~0.015	0.012	9,100	250	0.007~0.012	0.012
22	10,300	300	0.006~0.009	0.004	8,700	230	0.005~0.008	0.004	7,800	180	0.004~0.006	0.004		

- 3mm Shank V Series
- UDC-PCD Series
- CBN Series
- Square
- Long Neck Square
- Radius
- Long Neck Radius
- Taper Neck Radius
- Ball / Long Shank Ball
- Long Neck Ball
- Taper Neck Ball
- Taper
- Barrel
- Spiral V Cutter
- Drill
- Technical Data

Milling Conditions for HLS (2 Flutes)

WORK MATERIAL			HARDENED STEELS SKD / SKT (45~55HRC)				HARDENED STEELS SKD / SKH (55~60HRC)			
Model Number	Outside Diameter (mm)	Effective Length (mm)	Spindle Speed (min ⁻¹)	Feed Rate (mm/min)	a _p Axial Depth (mm)	a _e Radial Depth (mm)	Spindle Speed (min ⁻¹)	Feed Rate (mm/min)	a _p Axial Depth (mm)	a _e Radial Depth (mm)
2007	0.7	2	28,800	430	0.015~0.025	0.165	10,000	24	0.01 ~0.015	0.165
		4	20,600	290	0.009~0.014	0.047	10,000	22	0.006~0.009	0.047
		6	16,900	230	0.005~0.008	0.014	10,000	20	0.003~0.005	0.014
		8	14,700	190	0.003~0.005	0.006	10,000	18	0.002~0.003	0.006
		10	13,200	160	0.002~0.003	0.004	10,000	13	0.001~0.002	0.004
2008	0.8	3	21,000	370	0.016~0.027	0.15	8,000	21	0.012~0.016	0.15
		4	19,300	330	0.013~0.022	0.08	8,000	20	0.01 ~0.013	0.08
		5	17,600	290	0.01 ~0.017	0.052	8,000	19	0.008~0.01	0.052
		6	15,800	250	0.007~0.012	0.024	8,000	18	0.005~0.007	0.024
		8	13,800	200	0.004~0.007	0.01	8,000	16	0.003~0.004	0.01
		10	12,400	170	0.003~0.005	0.005	8,000	14	0.002~0.003	0.005
		12	11,300	140	0.002~0.003	0.003	8,000	12	0.001~0.002	0.003
		16	9,800	100	0.001~0.002	0.001	—	—	— ~ —	0.001
2009	0.9	4	18,000	380	0.016~0.027	0.128	7,200	20	0.01 ~0.014	0.128
		6	14,800	290	0.01 ~0.016	0.038	7,200	18	0.007~0.009	0.038
		8	12,900	230	0.006~0.01	0.016	7,200	16	0.004~0.006	0.016
		10	11,600	190	0.004~0.006	0.008	7,200	14	0.002~0.003	0.008
		15	9,500	120	0.002~0.003	0.002	—	—	— ~ —	0.002
2010	1	3	18,700	440	0.024~0.039	0.263	6,500	15	0.011~0.016	0.263
		4	17,200	400	0.02 ~0.033	0.195	6,500	15	0.01 ~0.015	0.195
		5	15,700	360	0.016~0.027	0.127	6,500	15	0.009~0.014	0.127
		6	14,100	310	0.012~0.02	0.058	6,500	14	0.007~0.012	0.058
		7	13,200	280	0.01 ~0.016	0.041	6,500	14	0.006~0.009	0.041
		8	12,300	250	0.007~0.012	0.024	6,500	13	0.004~0.006	0.024
		9	11,700	230	0.006~0.01	0.019	6,500	13	0.004~0.005	0.019
		10	11,000	210	0.005~0.008	0.013	6,500	12	0.003~0.004	0.013
		12	10,100	170	0.003~0.006	0.007	6,500	11	0.002~0.003	0.007
		14	9,400	150	0.002~0.004	0.005	6,500	10	0.001~0.002	0.005
		16	8,800	130	0.002~0.003	0.003	—	—	— ~ —	0.003
		18	8,350	110	0.001~0.002	0.002	—	—	— ~ —	0.002
		20	7,900	90	0.001~0.002	0.002	—	—	— ~ —	0.002
25	7,100	60	0.001~0.001	0.001	—	—	— ~ —	0.001		
30	6,500	40	0.001~0.001	—	—	—	— ~ —	—		
2012	1.2	4	14,500	400	0.026~0.042	0.23	9,600	34	0.015~0.026	0.23
		6	12,800	340	0.019~0.031	0.12	9,600	22	0.011~0.019	0.12
		8	11,100	280	0.012~0.02	0.051	9,600	10	0.007~0.012	0.051
		10	9,900	230	0.008~0.013	0.026	—	—	— ~ —	0.026
		12	9,100	200	0.005~0.009	0.015	—	—	— ~ —	0.015
		16	7,900	150	0.003~0.005	0.006	—	—	— ~ —	0.006
		20	7,000	120	0.002~0.003	0.003	—	—	— ~ —	0.003
2014	1.4	6	11,900	370	0.026~0.043	0.222	9,600	44	0.015~0.026	0.222
		8	10,300	310	0.018~0.029	0.094	9,600	18	0.01 ~0.017	0.094
		10	9,200	260	0.012~0.021	0.048	—	—	— ~ —	0.048
		12	8,400	230	0.009~0.015	0.028	—	—	— ~ —	0.028
		14	7,800	200	0.007~0.011	0.018	—	—	— ~ —	0.018
		16	7,300	180	0.005~0.009	0.012	—	—	— ~ —	0.012
		22	6,200	120	0.003~0.005	0.004	—	—	— ~ —	0.004

Ø3mm Shank
V SeriesUDC-PCD
SeriesCBN
Series

Square

Square
Long Neck
Square

Radius

Radius
Long Neck
Radius
Taper Neck
Radius

Ball

Ball / Long
Shank Ball
Long Neck
Ball
Taper Neck
Ball

Taper

Taper

Barrel

Spiral
V Cutter

Drill

Technical Data

Milling Conditions for HLS (2 Flutes)

WORK MATERIAL			CARBON STEELS S45C / S50C (~225HB)				ALLOY STEELS SK / SCM / SUS (225~325HB)				PREHARDENED STEELS HARDENED STEELS NAK / SKD(30~45HRC)			
Model Number	Outside Diameter (mm)	Effective Length (mm)	Spindle Speed (min ⁻¹)	Feed Rate (mm/min)	a _p Axial Depth (mm)	a _e Radial Depth (mm)	Spindle Speed (min ⁻¹)	Feed Rate (mm/min)	a _p Axial Depth (mm)	a _e Radial Depth (mm)	Spindle Speed (min ⁻¹)	Feed Rate (mm/min)	a _p Axial Depth (mm)	a _e Radial Depth (mm)
2015	1.5	4	26,600	1,340	0.073~0.12	0.462	22,100	1,000	0.065~0.109	0.462	16,300	640	0.051~0.084	0.462
		6	22,800	1,120	0.057~0.094	0.293	19,000	840	0.051~0.085	0.293	14,400	550	0.04~0.066	0.293
		8	19,000	900	0.041~0.068	0.124	15,900	670	0.037~0.061	0.124	12,500	460	0.029~0.048	0.124
		10	16,600	750	0.03~0.05	0.063	13,800	560	0.027~0.045	0.063	11,200	390	0.021~0.035	0.063
		12	14,800	630	0.023~0.038	0.037	12,400	470	0.02~0.034	0.037	10,200	340	0.016~0.026	0.037
		14	13,400	550	0.017~0.029	0.023	11,200	410	0.016~0.026	0.023	9,500	300	0.012~0.02	0.023
		16	12,300	480	0.013~0.022	0.015	10,300	360	0.012~0.02	0.015	8,900	270	0.009~0.016	0.015
		18	11,500	420	0.011~0.018	0.011	9,600	310	0.01~0.016	0.011	8,400	240	0.007~0.012	0.011
		20	10,700	370	0.009~0.014	0.008	9,000	280	0.008~0.013	0.008	7,900	220	0.006~0.01	0.008
		25	9,300	270	0.005~0.009	0.004	7,800	200	0.005~0.008	0.004	7,100	160	0.004~0.006	0.004
		30	8,300	200	0.004~0.007	0.002	7,000	150	0.004~0.006	0.002	6,500	120	0.003~0.005	0.002
		35	7,600	140	0.003~0.004	0.001	6,400	110	0.003~0.004	0.001	6,000	90	0.002~0.003	0.001
		40	7,000	90	0.002~0.003	0.001	5,800	70	0.002~0.003	0.001	5,600	60	0.002~0.002	0.001
45	6,500	60	0.002~0.003	0.001	5,400	50	0.002~0.002	0.001	5,300	40	0.001~0.002	0.001		
2016	1.6	6	22,200	1,170	0.065~0.108	0.379	18,500	870	0.058~0.097	0.379	13,800	570	0.045~0.076	0.379
		8	18,500	940	0.047~0.079	0.16	15,500	700	0.042~0.071	0.16	12,000	480	0.033~0.055	0.16
		10	16,100	780	0.035~0.058	0.082	13,500	580	0.032~0.053	0.082	10,800	410	0.025~0.041	0.082
		12	14,400	670	0.027~0.044	0.047	12,000	500	0.024~0.04	0.047	9,800	360	0.019~0.031	0.047
		14	13,000	580	0.02~0.034	0.03	10,900	430	0.018~0.031	0.03	9,100	320	0.014~0.024	0.03
		16	12,000	510	0.016~0.027	0.02	10,000	380	0.014~0.024	0.02	8,500	280	0.011~0.019	0.02
		18	11,100	450	0.013~0.022	0.014	9,300	340	0.012~0.019	0.014	8,000	260	0.009~0.015	0.014
		20	10,400	400	0.011~0.018	0.01	8,700	300	0.01~0.016	0.01	7,600	230	0.007~0.012	0.01
		26	8,800	280	0.007~0.011	0.005	7,400	210	0.006~0.01	0.005	6,700	170	0.005~0.008	0.005
2018	1.8	6	21,000	1,270	0.061~0.102	0.608	17,800	950	0.055~0.092	0.608	12,800	600	0.043~0.071	0.608
		8	17,700	1,020	0.05~0.083	0.256	14,900	760	0.045~0.075	0.256	11,100	500	0.035~0.058	0.256
		10	15,400	860	0.041~0.068	0.131	12,900	640	0.037~0.061	0.131	9,900	430	0.029~0.048	0.131
		12	13,800	740	0.033~0.055	0.076	11,500	550	0.03~0.05	0.076	9,100	380	0.023~0.039	0.076
		14	12,500	640	0.027~0.045	0.048	10,500	480	0.024~0.041	0.048	8,400	340	0.019~0.032	0.048
		16	11,500	570	0.022~0.037	0.032	9,600	420	0.02~0.033	0.032	7,800	300	0.016~0.026	0.032
		18	10,700	500	0.018~0.03	0.023	8,900	380	0.016~0.027	0.023	7,400	280	0.013~0.021	0.023
		20	10,000	450	0.015~0.025	0.016	8,400	340	0.013~0.022	0.016	7,000	250	0.01~0.017	0.016
		25	8,700	350	0.009~0.015	0.008	7,300	260	0.008~0.014	0.008	6,300	200	0.006~0.011	0.008
2020	2	6	20,300	1,350	0.064~0.107	0.926	17,400	1,030	0.058~0.097	0.926	12,500	650	0.045~0.075	0.926
		8	17,000	1,090	0.054~0.089	0.391	14,500	830	0.048~0.081	0.391	10,800	540	0.038~0.063	0.391
		10	14,800	920	0.045~0.075	0.2	12,600	700	0.04~0.067	0.2	9,700	470	0.031~0.052	0.2
		12	13,200	790	0.037~0.062	0.116	11,200	600	0.034~0.056	0.116	8,900	420	0.026~0.044	0.116
		14	12,000	700	0.031~0.052	0.073	10,200	530	0.028~0.047	0.073	8,200	370	0.022~0.036	0.073
		16	11,100	620	0.026~0.044	0.049	9,400	470	0.024~0.039	0.049	7,700	340	0.018~0.03	0.049
		18	10,300	550	0.022~0.036	0.034	8,700	420	0.02~0.033	0.034	7,200	310	0.015~0.026	0.034
		20	9,600	500	0.018~0.031	0.025	8,100	380	0.016~0.027	0.025	6,900	280	0.013~0.021	0.025
		25	8,400	390	0.012~0.02	0.013	7,100	290	0.011~0.018	0.013	6,200	230	0.008~0.014	0.013
		30	7,500	310	0.008~0.013	0.007	6,300	230	0.007~0.012	0.007	5,600	180	0.005~0.009	0.007
		35	6,800	250	0.005~0.008	0.005	5,700	190	0.005~0.008	0.005	5,200	150	0.004~0.006	0.005
		40	6,300	200	0.003~0.006	0.003	5,200	150	0.003~0.005	0.003	4,900	120	0.002~0.004	0.003
		50	5,400	110	0.003~0.004	0.002	4,500	90	0.002~0.002	0.002	4,400	70	0.002~0.002	0.002
60	4,900	50	0.002~0.003	0.002	4,000	40	0.002~0.002	0.002	4,000	30	0.002~0.002	0.002		

Milling Conditions for HLS (2 Flutes)

WORK MATERIAL			HARDENED STEELS SKD / SKT (45~55HRC)				HARDENED STEELS SKD / SKH (55~60HRC)			
Model Number	Outside Diameter (mm)	Effective Length (mm)	Spindle Speed (min ⁻¹)	Feed Rate (mm/min)	a _p Axial Depth (mm)	a _e Radial Depth (mm)	Spindle Speed (min ⁻¹)	Feed Rate (mm/min)	a _p Axial Depth (mm)	a _e Radial Depth (mm)
2015	1.5	4	13,000	440	0.036~0.06	0.462	9,600	95	0.02 ~0.036	0.462
		6	11,500	380	0.028~0.047	0.293	9,600	60	0.016~0.028	0.293
		8	10,000	320	0.02 ~0.034	0.124	9,600	25	0.012~0.02	0.124
		10	8,900	270	0.015~0.025	0.063	9,600	13	0.009~0.015	0.063
		12	8,200	240	0.011~0.019	0.037	—	—	— ~ —	0.037
		14	7,600	210	0.009~0.014	0.023	—	—	— ~ —	0.023
		16	7,100	190	0.007~0.011	0.015	—	—	— ~ —	0.015
		18	6,700	170	0.005~0.009	0.011	—	—	— ~ —	0.011
		20	6,300	150	0.004~0.007	0.008	—	—	— ~ —	0.008
		25	5,700	110	0.003~0.005	0.004	—	—	— ~ —	0.004
		30	5,200	90	0.002~0.003	0.002	—	—	— ~ —	0.002
		35	4,800	60	0.002~0.002	0.001	—	—	— ~ —	0.001
		40	4,500	40	0.001~0.002	0.001	—	—	— ~ —	0.001
		45	4,300	30	0.001~0.001	0.001	—	—	— ~ —	0.001
2016	1.6	6	11,100	400	0.032~0.054	0.379	9,600	73	0.019~0.032	0.379
		8	9,600	330	0.024~0.039	0.16	9,600	31	0.014~0.023	0.16
		10	8,600	280	0.018~0.029	0.082	9,600	15	0.01 ~0.017	0.082
		12	7,900	250	0.013~0.022	0.047	—	—	— ~ —	0.047
		14	7,300	220	0.01 ~0.017	0.03	—	—	— ~ —	0.03
		16	6,800	200	0.008~0.013	0.02	—	—	— ~ —	0.02
		18	6,400	180	0.006~0.011	0.014	—	—	— ~ —	0.014
		20	6,100	160	0.005~0.009	0.01	—	—	— ~ —	0.01
		26	5,300	120	0.003~0.005	0.005	—	—	— ~ —	0.005
2018	1.8	6	10,200	410	0.031~0.051	0.608	9,600	137	0.018~0.031	0.608
		8	8,900	350	0.025~0.042	0.256	9,600	58	0.015~0.025	0.256
		10	7,900	300	0.02 ~0.034	0.131	9,600	29	0.012~0.02	0.131
		12	7,200	260	0.017~0.028	0.076	9,600	17	0.01 ~0.017	0.076
		14	6,700	230	0.014~0.023	0.048	9,600	10	0.008~0.014	0.048
		16	6,300	210	0.011~0.019	0.032	—	—	— ~ —	0.032
		18	5,900	190	0.009~0.015	0.023	—	—	— ~ —	0.023
		20	5,600	170	0.007~0.012	0.016	—	—	— ~ —	0.016
2020	2	6	10,000	450	0.032~0.054	0.926	9,600	211	0.019~0.032	0.926
		8	8,700	380	0.027~0.045	0.391	9,600	89	0.016~0.027	0.391
		10	7,800	330	0.022~0.037	0.2	9,600	45	0.013~0.022	0.2
		12	7,100	290	0.019~0.031	0.116	9,600	28	0.011~0.019	0.116
		14	6,600	260	0.016~0.026	0.073	9,600	16	0.009~0.016	0.073
		16	6,100	230	0.013~0.022	0.049	9,600	11	0.007~0.013	0.049
		18	5,800	210	0.011~0.018	0.034	—	—	— ~ —	0.034
		20	5,500	190	0.009~0.015	0.025	—	—	— ~ —	0.025
		25	4,900	160	0.006~0.01	0.013	—	—	— ~ —	0.013
		30	4,500	130	0.004~0.006	0.007	—	—	— ~ —	0.007
		35	4,200	100	0.003~0.004	0.005	—	—	— ~ —	0.005
		40	3,900	80	0.002~0.003	0.003	—	—	— ~ —	0.003
		50	3,500	50	0.001~0.001	0.002	—	—	— ~ —	0.002
		60	3,200	30	0.001~0.001	0.002	—	—	— ~ —	0.002

φ3mm Shank
V Series

UDC-PCD
Series

CBN
Series

Square

Long Neck
Square

Radius

Long Neck
Radius

Taper Neck
Radius

Ball / Long
Shank Ball

Long Neck
Ball

Taper Neck
Ball

Taper

Barrel

Spiral
V Cutter

Drill

Technical Data

Milling Conditions for HLS (2 Flutes)

WORK MATERIAL			CARBON STEELS S45C / S50C (~225HB)				ALLOY STEELS SK / SCM / SUS (225~325HB)				PREHARDENED STEELS HARDENED STEELS NAK / SKD(30~45HRC)			
Model Number	Outside Diameter (mm)	Effective Length (mm)	Spindle Speed (min ⁻¹)	Feed Rate (mm/min)	a _p Axial Depth (mm)	a _e Radial Depth (mm)	Spindle Speed (min ⁻¹)	Feed Rate (mm/min)	a _p Axial Depth (mm)	a _e Radial Depth (mm)	Spindle Speed (min ⁻¹)	Feed Rate (mm/min)	a _p Axial Depth (mm)	a _e Radial Depth (mm)
2025	2.5	8	15,000	1,340	0.077~0.129	0.954	12,800	1,020	0.069~0.116	0.954	9,600	670	0.054~0.09	0.954
		10	13,100	1,140	0.068~0.113	0.488	11,100	860	0.061~0.102	0.488	8,600	590	0.048~0.079	0.488
		12	11,800	1,000	0.06~0.099	0.283	10,000	750	0.054~0.089	0.283	7,900	520	0.042~0.07	0.283
		14	10,700	880	0.052~0.087	0.178	9,100	660	0.047~0.078	0.178	7,300	470	0.036~0.061	0.178
		16	9,900	790	0.045~0.075	0.119	8,400	590	0.04~0.067	0.119	6,800	430	0.031~0.052	0.119
		18	9,200	710	0.039~0.064	0.084	7,800	540	0.035~0.058	0.084	6,500	390	0.027~0.045	0.084
		20	8,700	650	0.033~0.055	0.061	7,300	490	0.03~0.05	0.061	6,100	360	0.023~0.039	0.061
		25	7,600	520	0.022~0.036	0.031	6,400	390	0.019~0.032	0.031	5,500	300	0.015~0.025	0.031
		30	6,800	430	0.014~0.023	0.018	5,700	320	0.012~0.02	0.018	5,000	250	0.01~0.016	0.018
		40	5,700	290	0.005~0.008	0.008	4,800	220	0.004~0.007	0.008	4,400	170	0.003~0.006	0.008
		50	5,000	190	0.003~0.004	0.004	4,200	140	0.002~0.004	0.004	3,900	120	0.002~0.003	0.004
		2030	3	8	13,200	1,470	0.103~0.172	1.978	10,900	1,080	0.093~0.155	1.978	8,000	700
10	11,600			1,270	0.092~0.153	1.013	9,600	930	0.083~0.138	1.013	7,200	620	0.064~0.107	1.013
12	10,500			1,110	0.081~0.136	0.586	8,700	830	0.073~0.122	0.586	6,700	560	0.057~0.095	0.586
14	9,600			1,000	0.072~0.12	0.369	8,000	740	0.065~0.108	0.369	6,200	510	0.051~0.084	0.369
16	8,900			900	0.064~0.107	0.247	7,400	670	0.058~0.096	0.247	5,900	470	0.045~0.075	0.247
18	8,300			820	0.057~0.094	0.174	7,000	610	0.051~0.085	0.174	5,600	430	0.04~0.066	0.174
20	7,800			750	0.05~0.083	0.127	6,600	560	0.045~0.075	0.127	5,300	400	0.035~0.058	0.127
25	6,900			620	0.036~0.06	0.065	5,800	460	0.032~0.054	0.065	4,800	340	0.025~0.042	0.065
30	6,200			520	0.026~0.043	0.038	5,200	390	0.023~0.039	0.038	4,500	290	0.018~0.03	0.038
35	5,700			440	0.018~0.031	0.024	4,800	330	0.016~0.027	0.024	4,200	250	0.013~0.021	0.024
40	5,300			370	0.013~0.021	0.016	4,500	280	0.012~0.019	0.016	3,900	220	0.009~0.015	0.016
50	4,700			270	0.006~0.01	0.008	3,900	200	0.005~0.009	0.008	3,600	160	0.004~0.007	0.008
2040	4	12	8,500	1,280	0.112~0.187	1.852	7,100	950	0.101~0.168	1.852	5,100	600	0.078~0.131	1.852
		16	7,200	1,050	0.093~0.155	0.781	6,000	770	0.084~0.139	0.781	4,400	510	0.065~0.108	0.781
		20	6,300	880	0.077~0.128	0.4	5,200	650	0.069~0.115	0.4	4,000	440	0.054~0.09	0.4
		25	5,600	750	0.061~0.101	0.205	4,600	540	0.055~0.091	0.205	3,600	380	0.042~0.071	0.205
		30	5,000	630	0.048~0.08	0.119	4,100	460	0.043~0.072	0.119	3,300	330	0.033~0.056	0.119
		35	4,600	540	0.038~0.063	0.075	3,800	400	0.034~0.057	0.075	3,100	290	0.026~0.044	0.075
		40	4,200	470	0.03~0.049	0.05	3,500	350	0.027~0.044	0.05	2,900	250	0.021~0.035	0.05
		45	3,900	410	0.023~0.039	0.035	3,300	300	0.021~0.035	0.035	2,700	230	0.016~0.027	0.035
		50	3,700	360	0.018~0.031	0.026	3,100	270	0.016~0.027	0.026	2,600	200	0.013~0.021	0.026
		60	3,300	280	0.011~0.019	0.015	2,800	210	0.01~0.017	0.015	2,400	160	0.008~0.013	0.015
		16	6,000	1,140	0.127~0.212	1.907	5,100	860	0.114~0.191	1.907	3,500	520	0.089~0.148	1.907
		20	5,300	980	0.121~0.202	0.977	4,400	730	0.109~0.182	0.977	3,100	440	0.085~0.142	0.977
25	4,600	820	0.109~0.182	0.5	3,800	600	0.099~0.164	0.5	2,800	390	0.077~0.128	0.5		
30	4,200	710	0.094~0.157	0.289	3,400	510	0.085~0.141	0.289	2,500	340	0.066~0.11	0.289		
35	3,800	620	0.077~0.128	0.182	3,100	450	0.069~0.115	0.182	2,300	300	0.054~0.09	0.182		
40	3,500	540	0.06~0.099	0.122	2,800	390	0.054~0.089	0.122	2,200	270	0.042~0.07	0.122		
50	3,100	430	0.031~0.052	0.063	2,400	300	0.028~0.047	0.063	1,900	210	0.022~0.036	0.063		
60	2,800	350	0.02~0.035	0.035	2,100	240	0.02~0.033	0.035	1,800	170	0.019~0.031	0.035		
2060	6	20	4,200	960	0.126~0.211	2.025	3,800	780	0.114~0.19	2.025	2,600	470	0.088~0.147	2.025
		30	3,400	730	0.109~0.182	0.6	2,800	540	0.099~0.164	0.6	2,000	340	0.077~0.128	0.6
		40	3,000	600	0.083~0.138	0.253	2,300	410	0.074~0.124	0.253	1,700	260	0.058~0.096	0.253
		50	2,600	480	0.054~0.09	0.13	1,900	310	0.049~0.081	0.13	1,500	220	0.038~0.063	0.13
		60	2,400	410	0.031~0.052	0.075	1,700	260	0.028~0.047	0.075	1,300	170	0.022~0.036	0.075

- 3mm Shank V Series
- UDC-PCD Series
- CBN Series
- Square
- Long Neck Square
- Radius
- Long Neck Radius
- Taper Neck Radius
- Ball / Long Shank Ball
- Long Neck Ball
- Taper Neck Ball
- Taper
- Barrel
- Spiral V Cutter
- Drill
- Technical Data

Milling Conditions for HLS (2 Flutes)

WORK MATERIAL			HARDENED STEELS SKD / SKT (45~55HRC)				HARDENED STEELS SKD / SKH (55~60HRC)			
Model Number	Outside Diameter (mm)	Effective Length (mm)	Spindle Speed (min ⁻¹)	Feed Rate (mm/min)	a_p Axial Depth (mm)	a_e Radial Depth (mm)	Spindle Speed (min ⁻¹)	Feed Rate (mm/min)	a_p Axial Depth (mm)	a_e Radial Depth (mm)
2025	2.5	8	7,700	460	0.039~0.064	0.954	9,600	227	0.023~0.038	0.954
		10	6,900	400	0.034~0.057	0.488	9,600	116	0.02~0.034	0.488
		12	6,300	360	0.03~0.05	0.283	9,600	67	0.018~0.03	0.283
		14	5,800	320	0.026~0.043	0.178	9,600	42	0.015~0.026	0.178
		16	5,500	290	0.022~0.037	0.119	9,600	28	0.013~0.022	0.119
		18	5,200	270	0.019~0.032	0.084	9,600	20	0.011~0.019	0.084
		20	4,900	250	0.017~0.028	0.061	9,600	14	0.01~0.017	0.061
		25	4,400	210	0.011~0.018	0.031	—	—	—~—	0.031
		30	4,000	170	0.007~0.011	0.018	—	—	—~—	0.018
		40	3,500	120	0.002~0.004	0.008	—	—	—~—	0.008
		50	3,100	80	0.002~0.002	0.004	—	—	—~—	0.004
2030	3	8	6,400	480	0.052~0.086	1.978	8,000	435	0.031~0.052	1.978
		10	5,800	430	0.046~0.076	1.013	8,000	222	0.027~0.046	1.013
		12	5,300	380	0.041~0.068	0.586	8,000	128	0.024~0.041	0.586
		14	5,000	350	0.036~0.06	0.369	8,000	81	0.021~0.036	0.369
		16	4,700	320	0.032~0.053	0.247	8,000	54	0.019~0.032	0.247
		18	4,500	300	0.028~0.047	0.174	8,000	38	0.016~0.028	0.174
		20	4,300	280	0.025~0.042	0.127	8,000	27	0.015~0.025	0.127
		25	3,900	230	0.018~0.03	0.065	8,000	14	0.01~0.018	0.065
		30	3,600	200	0.013~0.022	0.038	8,000	10	0.007~0.013	0.038
		35	3,300	170	0.009~0.015	0.024	—	—	—~—	0.024
		40	3,100	150	0.006~0.011	0.016	—	—	—~—	0.016
		50	2,800	110	0.003~0.005	0.008	—	—	—~—	0.008
2040	4	12	4,100	410	0.056~0.093	1.852	6,000	388	0.033~0.056	1.852
		16	3,600	350	0.046~0.077	0.781	6,000	164	0.027~0.046	0.781
		20	3,200	300	0.038~0.064	0.4	6,000	84	0.022~0.038	0.4
		25	2,900	260	0.03~0.051	0.205	6,000	43	0.018~0.031	0.205
		30	2,600	230	0.024~0.04	0.119	6,000	24	0.014~0.024	0.119
		35	2,500	200	0.019~0.031	0.075	6,000	15	0.011~0.019	0.075
		40	2,300	180	0.015~0.025	0.05	6,000	10	0.009~0.015	0.05
		45	2,200	160	0.012~0.019	0.035	—	—	—~—	0.035
		50	2,100	140	0.009~0.015	0.026	—	—	—~—	0.026
		60	1,900	110	0.006~0.009	0.015	—	—	—~—	0.015
2050	5	16	2,800	360	0.064~0.106	1.907	4,800	457	0.038~0.064	1.907
		20	2,500	310	0.061~0.101	0.977	4,800	234	0.036~0.061	0.977
		25	2,200	270	0.055~0.091	0.5	4,800	120	0.033~0.055	0.5
		30	2,000	230	0.047~0.078	0.289	4,800	69	0.028~0.047	0.289
		35	1,900	210	0.038~0.064	0.182	4,800	43	0.022~0.038	0.182
		40	1,700	180	0.03~0.05	0.122	4,800	29	0.018~0.03	0.122
		50	1,500	150	0.016~0.026	0.063	4,800	15	0.009~0.016	0.063
60	1,400	120	0.007~0.011	0.035	4,800	10	0.004~0.007	0.035		
2060	6	20	2,100	330	0.063~0.105	2.025	4,000	607	0.037~0.063	2.025
		30	1,600	240	0.055~0.091	0.6	4,000	180	0.033~0.055	0.6
		40	1,300	170	0.041~0.069	0.253	4,000	75	0.024~0.041	0.253
		50	1,200	160	0.027~0.045	0.13	4,000	38	0.016~0.027	0.13
		60	1,000	120	0.016~0.026	0.075	4,000	22	0.009~0.016	0.075

Side Milling

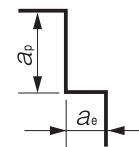

Slotting

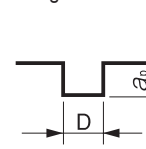

D : Outside Diameter (mm)

Note:

- Recommend using a non-contact measuring device to avoid damaging the precision tip point.
- Decrease both spindle speed and feed rate proportionally when the milling parameters exceed the machine's maximum spindle speed.
- Every coolant offers stable milling.
- Recommend oil coolant for Stainless Steels and Heat Resistant Alloys.
- Recommend wet coolant for Copper.

Ø3mm Shank
V SeriesUDC-PCD
SeriesCBN
SeriesSquare
Long Neck
SquareRadius
Long Neck
Radius
Taper Neck
RadiusBall / Long
Shank Ball
Long Neck
Ball
Taper Neck
Ball

Taper

Barrel

Spiral
V Cutter

Drill

Technical Data



Size $\phi 0.1 \sim \phi 6$

C-CER



Material Applications (★ Highly Recommended ● Recommended ○ Suggested)

Work Material																	
Carbon Steels S45C S55C	Alloy Steels SK / SCM SUS	Prehardened Steels NAK HPM	Hardened Steels					Cast Iron	Aluminum Alloys	Graphite	Copper	Plastics	Glass Filled Plastics	Titanium Alloys	Heat Resistant Alloys	Cemented Carbide	Hard Brittle (Non-Metallic) Materials
			~50HRC	~55HRC	~60HRC	~65HRC	~70HRC										
●	●	●	●	○				○			●			○	○		

Features

Long neck square end mill with a positive rake angle.
Best suited for Raw materials, Copper, SUS and materials 55HRC and below.

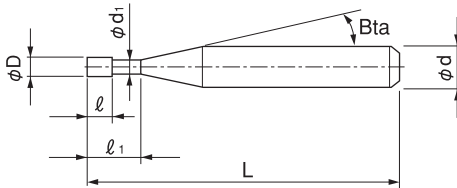

The shank taper angle shown is not an exact value and to avoid contact with the work piece, we recommend the user controls the precise value of this angle. Shank taper angle should not make contact with the work piece.

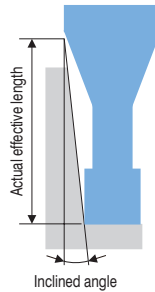

C-CER Cutting edge

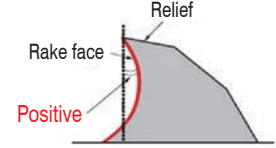

HLS Cutting edge

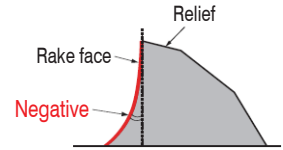

Total 148 models

Unit (mm)

Model Number	Outside Diameter ϕD	Effective Length l_1	Length of Cut l	Neck Diameter ϕd_1	Shank Taper Angle Bta	Overall Length L	Shank Diameter ϕd	Suggested Retail Price ¥	Effective Length by Inclined Angles				
									30°	1°	1° 30'	2°	3°
C-CER 2001-0.3	0.1	0.3	0.1	0.088	11°	45	4	11,160	0.32	0.35	0.38	0.40	0.47
C-CER 2001-0.5		0.5											
C-CER 2001-0.75		0.75											
C-CER 2001-1		1											
C-CER 20015-0.5	0.15	0.5	0.15	0.128	11°	45	4	11,400	0.57	0.61	0.65	0.69	0.79
C-CER 20015-0.75		0.75											
C-CER 20015-1		1											
C-CER 2002-0.5		0.5											
C-CER 2002-1	0.2	1	0.3	0.18	16°	45	4	9,360	1.18	1.25	1.31	1.36	1.45
C-CER 2002-1.5		1.5											
C-CER 2002-2		2											
C-CER 2002-3		3											
C-CER 2003-1	0.3	1	0.4	0.28	16°	45	4	7,560	1.22	1.30	1.37	1.43	1.55
C-CER 2003-1.5		1.5											
C-CER 2003-2		2											
C-CER 2003-3		3											

Unit (mm)

Model Number	Outside Diameter ϕD	Effective Length ℓ_1	Length of Cut ℓ	Neck Diameter ϕd_1	Shank Taper Angle Bta	Overall Length L	Shank Diameter ϕd	Suggested Retail Price ¥	Effective Length by Inclined Angles				
									30'	1°	1° 30'	2°	3°
C-CER 2004-2	0.4	2	0.6	0.38	16°	45	4	6,700	2.31	2.47	2.60	2.71	2.91
C-CER 2004-3		3				45	4	5,520	3.38	3.57	3.72	3.85	4.07
C-CER 2004-4		4				45	4	5,520	4.44	4.65	4.82	4.96	5.21
C-CER 2004-5		5				45	4	5,520	5.49	5.73	5.91	6.06	6.33
C-CER 2005-2	0.5	2	0.7	0.48	16°	45	4	3,960	2.37	2.56	2.71	2.85	3.09
C-CER 2005-4		4				45	4	3,960	4.52	4.77	4.97	5.14	5.44
C-CER 2005-6		6				45	4	3,960	6.64	6.94	7.17	7.37	7.71
C-CER 2005-8		8				45	4	6,600	8.74	9.07	9.33	9.56	9.93
C-CER 2006-2	0.6	2	0.9	0.58	16°	45	4	4,200	2.35	2.59	2.78	2.94	3.23
C-CER 2006-4		4				45	4	4,200	4.54	4.84	5.08	5.28	5.68
C-CER 2006-6		6				45	4	4,200	6.68	7.03	7.30	7.56	8.13
C-CER 2006-8		8				45	4	6,840	8.80	9.19	9.51	9.84	10.58
C-CER 2006-10	10	45	4	7,920	10.90	11.33	11.71	12.11	13.02				
C-CER 2007-2	0.7	2	1	0.68	16°	45	4	4,800	2.35	2.59	2.78	2.94	3.23
C-CER 2007-3		3				45	4	4,800	3.46	3.73	3.94	4.13	4.46
C-CER 2007-4		4				45	4	4,800	4.54	4.84	5.08	5.28	5.68
C-CER 2007-6		6				45	4	4,800	6.68	7.03	7.30	7.56	8.13
C-CER 2007-8		8				45	4	7,000	8.80	9.19	9.51	9.84	10.58
C-CER 2007-10		10				50	4	8,000	10.90	11.33	11.71	12.11	13.02
C-CER 2008-4	0.8	4	1.2	0.78	16°	45	4	4,680	4.54	4.84	5.08	5.28	5.68
C-CER 2008-6		6				45	4	4,680	6.68	7.03	7.30	7.56	8.13
C-CER 2008-8		8				45	4	4,680	8.80	9.19	9.51	9.84	10.58
C-CER 2008-10		10				50	4	6,840	10.90	11.33	11.71	12.11	13.02
C-CER 2008-12		12				50	4	7,800	12.99	13.45	13.91	14.39	15.47
C-CER 2009-4		0.9				4	1.3	0.88	16°	45	4	5,000	4.54
C-CER 2009-6	6		45	4	5,400	6.68				7.03	7.30	7.56	8.13
C-CER 2009-8	8		45	4	5,400	8.80				9.19	9.51	9.84	10.58
C-CER 2009-10	10		45	4	5,400	10.90				11.33	11.71	12.11	13.02
C-CER 2009-15	15		50	4	8,000	16.11				16.65	17.21	17.81	19.14
C-CER 2010-4	1		4	1.5	0.95	16°				45	4	4,200	4.66
C-CER 2010-6		6	45				4	4,200	6.78	7.10	7.36	7.62	8.19
C-CER 2010-8		8	45				4	4,200	8.88	9.25	9.56	9.90	10.64
C-CER 2010-10		10	45				4	4,200	10.97	11.38	11.76	12.17	13.09
C-CER 2010-12		12	45				4	4,200	13.06	13.51	13.97	14.45	15.53
C-CER 2010-16		16	50				4	6,840	17.20	17.77	18.37	19.01	20.43
C-CER 2010-20	20	55	4	6,840	21.34	22.03	22.77	23.56	25.32				
C-CER 2012-6	1.2	6	1.8	1.14	11°	45	4	4,440	6.29	6.61	6.95	7.34	8.25
C-CER 2012-8		8				45	4	4,440	8.39	8.80	9.26	9.78	10.99
C-CER 2012-10		10				45	4	4,440	10.48	11.00	11.58	12.21	13.72
C-CER 2012-12		12				45	4	4,440	12.58	13.20	13.89	14.65	16.46
C-CER 2012-16		16				50	4	7,080	16.76	17.59	18.51	19.53	21.94
C-CER 2014-6		1.4				6	2.1	1.34	11°	45	4	4,560	6.29
C-CER 2014-8	8		45	4	4,560	8.39				8.80	9.26	9.78	10.99
C-CER 2014-10	10		45	4	4,560	10.48				11.00	11.58	12.21	13.72
C-CER 2014-12	12		45	4	4,560	12.58				13.20	13.89	14.65	16.46
C-CER 2014-14	14		45	4	4,560	14.67				15.40	16.20	17.09	19.20
C-CER 2014-16	16		50	4	5,280	16.76				17.59	18.51	19.53	21.94
C-CER 2014-22	22		55	4	7,080	23.05				24.19	25.44	26.84	No Interference

3mm Shank V Series

UDC-PCD Series

CBN Series

Square
Long Neck SquareRadius
Long Neck Radius

Taper Neck Radius

Ball / Long Shank Ball

Ball
Long Neck Ball

Taper Neck Ball

Taper
Taper

Barrel

Spiral V Cutter

Drill

Technical Data

Model Number	Outside Diameter ϕD	Effective Length ℓ_1	Length of Cut ℓ	Neck Diameter ϕd_1	Shank Taper Angle Bta	Overall Length L	Shank Diameter ϕd	Suggested Retail Price ¥	Effective Length by Inclined Angles				
									30'	1°	1° 30'	2°	3°
C-CER 2015-6	1.5	6	2.3	1.44	11°	45	4	4,440	6.29	6.61	6.95	7.34	8.25
C-CER 2015-8		8				45	4	4,440	8.39	8.80	9.26	9.78	10.99
C-CER 2015-10		10				45	4	4,440	10.48	11.00	11.58	12.21	13.72
C-CER 2015-12		12				45	4	4,440	12.58	13.20	13.89	14.65	16.46
C-CER 2015-14		14				50	4	4,560	14.67	15.40	16.20	17.09	19.20
C-CER 2015-16		16				50	4	4,560	16.76	17.59	18.51	19.53	21.94
C-CER 2015-18		18				55	4	4,560	18.86	19.79	20.82	21.97	No Interference
C-CER 2015-20		20				55	4	4,560	20.95	21.99	23.13	24.40	No Interference
C-CER 2016-6		1.6				6	2.4	1.51	11°	45	4	4,560	6.35
C-CER 2016-8	8		45	4	4,560	8.44				8.86	9.32	9.84	11.06
C-CER 2016-10	10		45	4	4,560	10.54				11.06	11.64	12.28	13.79
C-CER 2016-12	12		45	4	4,560	12.63				13.26	13.95	14.71	16.53
C-CER 2016-14	14		50	4	4,560	14.72				15.45	16.26	17.15	19.27
C-CER 2016-16	16		50	4	4,560	16.82				17.65	18.57	19.59	22.01
C-CER 2016-18	18		55	4	4,560	18.91				19.85	20.88	22.03	No Interference
C-CER 2016-20	20		55	4	4,560	21.01				22.05	23.19	24.47	No Interference
C-CER 2016-26	26		60	4	7,200	27.29				28.64	30.13	31.78	No Interference
C-CER 2018-6	1.8	6	2.7	1.71	11°	45	4	4,560	6.35	6.66	7.01	7.40	8.32
C-CER 2018-8		8				45	4	4,560	8.44	8.86	9.32	9.84	11.06
C-CER 2018-10		10				45	4	4,560	10.54	11.06	11.64	12.28	13.79
C-CER 2018-12		12				45	4	4,560	12.63	13.26	13.95	14.71	16.53
C-CER 2018-14		14				50	4	4,560	14.72	15.45	16.26	17.15	19.27
C-CER 2018-16		16				50	4	4,560	16.82	17.65	18.57	19.59	No Interference
C-CER 2018-18		18				55	4	4,560	18.91	19.85	20.88	22.03	No Interference
C-CER 2018-20		20				55	4	4,560	21.01	22.05	23.19	24.47	No Interference
C-CER 2018-25		25				60	4	6,240	26.24	27.54	28.97	30.56	No Interference
C-CER 2020-6	2	6	3	1.91	11°	45	4	4,440	6.35	6.66	7.01	7.40	8.32
C-CER 2020-8		8				45	4	4,440	8.44	8.86	9.32	9.84	11.06
C-CER 2020-10		10				45	4	4,440	10.54	11.06	11.64	12.28	13.79
C-CER 2020-12		12				45	4	4,440	12.63	13.26	13.95	14.71	16.53
C-CER 2020-14		14				50	4	4,440	14.72	15.45	16.26	17.15	19.27
C-CER 2020-16		16				50	4	4,440	16.82	17.65	18.57	19.59	No Interference
C-CER 2020-18		18				55	4	4,440	18.91	19.85	20.88	22.03	No Interference
C-CER 2020-20		20				55	4	4,440	21.01	22.05	23.19	24.47	No Interference
C-CER 2020-25		25				60	4	4,440	26.24	27.54	28.97	No Interference	No Interference
C-CER 2020-30	30	70	4	5,520	31.48	33.03	34.75	No Interference	No Interference				
C-CER 2025-8	2.5	8	3.7	2.41	11°	45	4	4,680	8.44	8.86	9.32	9.84	11.06
C-CER 2025-10		10				45	4	4,680	10.54	11.06	11.64	12.28	13.79
C-CER 2025-12		12				45	4	4,680	12.63	13.26	13.95	14.71	No Interference
C-CER 2025-14		14				50	4	4,680	14.72	15.45	16.26	17.15	No Interference
C-CER 2025-16		16				50	4	4,680	16.82	17.65	18.57	19.59	No Interference
C-CER 2025-18		18				55	4	4,680	18.91	19.85	20.88	No Interference	No Interference
C-CER 2025-20		20				55	4	4,680	21.01	22.05	23.19	No Interference	No Interference
C-CER 2025-25		25				60	4	5,040	26.24	27.54	28.97	No Interference	No Interference
C-CER 2025-30		30				70	4	5,040	31.48	33.03	No Interference	No Interference	No Interference

- φ3mm Shank V Series
- UDC-PCD Series
- CBN Series
- Square
- Long Neck Square
- Radius
- Long Neck Radius
- Taper Neck Radius
- Ball / Long Shank Ball
- Long Neck Ball
- Taper Neck Ball
- Taper
- Barrel
- Spiral V Cutter
- Drill
- Technical Data

Unit (mm)

Model Number	Outside Diameter ϕD	Effective Length l_1	Length of Cut l	Neck Diameter ϕd_1	Shank Taper Angle Bta	Overall Length L	Shank Diameter ϕd	Suggested Retail Price ¥	Effective Length by Inclined Angles								
									30'	1°	1° 30'	2°	3°				
C-CER 2030-8	3	8	4.5	2.92	11°	45	6	6,000	8.44	8.86	9.32	9.83	11.05				
C-CER 2030-10		10				45	6	6,000	10.53	11.05	11.63	12.27	13.79				
C-CER 2030-12		12				50	6	6,000	12.62	13.25	13.94	14.71	16.53				
C-CER 2030-14		14				50	6	6,000	14.72	15.45	16.25	17.15	19.26				
C-CER 2030-16		16				60	6	6,000	16.81	17.65	18.56	19.58	22.00				
C-CER 2030-18		18				60	6	6,000	18.91	19.84	20.88	22.02	24.74				
C-CER 2030-20		20				60	6	6,000	21.00	22.04	23.19	24.46	27.48				
C-CER 2030-25		25				70	6	6,000	26.24	27.53	28.97	30.55	No Interference				
C-CER 2030-30		30				80	6	7,200	31.47	33.03	34.74	36.65	No Interference				
C-CER 2030-35		35				80	6	7,440	36.71	38.52	40.52	42.74	No Interference				
C-CER 2030-40		40				90	6	7,440	41.94	44.01	46.30	No Interference	No Interference				
C-CER 2035-12		3.5				12	5	3.37	11°	50	6	8,400	12.76	13.39	14.09	14.86	16.70
C-CER 2035-15	15		60	6	8,400	15.90				16.69	17.56	18.52	20.81				
C-CER 2035-16	16		60	6	8,400	16.95				17.79	18.71	19.74	22.18				
C-CER 2035-20	20		60	6	8,400	21.14				22.18	23.34	24.62	No Interference				
C-CER 2035-25	25		70	6	8,400	26.37				27.67	29.11	30.71	No Interference				
C-CER 2035-30	30		70	6	8,400	31.61				33.17	34.89	No Interference	No Interference				
C-CER 2035-35	35		80	6	8,400	36.84				38.66	40.67	No Interference	No Interference				
C-CER 2040-12	4		12	6	3.82	11°				50	6	6,960	12.89	13.53	14.24	15.02	16.88
C-CER 2040-16			16							60	6	6,960	17.08	17.93	18.86	19.90	No Interference
C-CER 2040-20			20							60	6	6,960	21.27	22.32	23.48	24.77	No Interference
C-CER 2040-25			25							70	6	6,960	26.51	27.82	29.26	No Interference	No Interference
C-CER 2040-30			30							70	6	6,960	31.74	33.31	35.04	No Interference	No Interference
C-CER 2040-35		35	80				6	6,960	36.98	38.80	No Interference	No Interference	No Interference				
C-CER 2040-40		40	90				6	8,760	42.21	44.30	No Interference	No Interference	No Interference				
C-CER 2040-45		45	90				6	10,440	47.45	49.79	No Interference	No Interference	No Interference				
C-CER 2040-50		50	100				6	12,960	52.68	55.28	No Interference	No Interference	No Interference				
C-CER 2050-16		5	16				7.5	4.82	11°	60	6	8,760	17.08	17.93	18.86	No Interference	No Interference
C-CER 2050-20			20							60	6	8,760	21.27	22.32	No Interference	No Interference	No Interference
C-CER 2050-25			25							60	6	8,760	26.51	27.82	No Interference	No Interference	No Interference
C-CER 2050-30	30		80	6	8,760	31.74				No Interference	No Interference	No Interference	No Interference				
C-CER 2050-35	35		80	6	8,760	36.98				No Interference	No Interference	No Interference	No Interference				
C-CER 2050-40	40		80	6	8,760	42.21				No Interference	No Interference	No Interference	No Interference				
C-CER 2050-50	50		110	6	13,800	52.68				No Interference	No Interference	No Interference	No Interference				
C-CER 2060-20	6		20	9	5.82	—				80	6	9,000	No Interference	No Interference	No Interference	No Interference	No Interference
C-CER 2060-30			30							80	6	9,240	No Interference	No Interference	No Interference	No Interference	No Interference
C-CER 2060-40			40							100	6	10,920	No Interference	No Interference	No Interference	No Interference	No Interference
C-CER 2060-50			50							120	6	13,800	No Interference	No Interference	No Interference	No Interference	No Interference
C-CER 2060-60			60							120	6	16,440	No Interference	No Interference	No Interference	No Interference	No Interference

33mm Shank
V SeriesUDC-PCD
SeriesCBN
Series

Square

Long Neck
Square

Radius

Long Neck
RadiusTaper Neck
RadiusBall / Long
Shank BallLong Neck
BallTaper Neck
Ball

Taper

Barrel

Spiral
V Cutter

Drill

Technical Data

Milling Conditions for C-CER

WORK MATERIAL			COPPER OFC / TPC			CARBON STEELS S45C / S50C (~225HB)			ALLOY STEELS SK / SCM / SUS (225~325HB)			PREHARDENED STEELS HARDENED STEELS NAK / SKD (30~45HRC)			HARDENED STEELS SKD / SKT (45~50HRC)		
Model Number	Outside Diameter (mm)	Effective Length (mm)	Spindle Speed (min ⁻¹)	Feed Rate (mm/min)	a _p Axial Depth (mm)	Spindle Speed (min ⁻¹)	Feed Rate (mm/min)	a _p Axial Depth (mm)	Spindle Speed (min ⁻¹)	Feed Rate (mm/min)	a _p Axial Depth (mm)	Spindle Speed (min ⁻¹)	Feed Rate (mm/min)	a _p Axial Depth (mm)	Spindle Speed (min ⁻¹)	Feed Rate (mm/min)	a _p Axial Depth (mm)
2001	0.1	0.3	30,000	30	0.003~0.006	30,000	30	0.003~0.005	30,000	15	0.002~0.005	30,000	16	0.001~0.004	—	—	—
		0.5	28,000	28	0.002~0.006	28,000	28	0.002~0.005	28,000	14	0.002~0.004	28,000	14	0.001~0.003	—	—	—
		0.75	25,500	26	0.002~0.005	25,500	26	0.002~0.004	25,500	13	0.002~0.003	25,500	12	0.001~0.002	—	—	—
		1	23,000	5	0.002~0.004	23,000	5	0.001~0.002	23,000	5	0.001~0.002	23,000	5	0.001	—	—	—
20015	0.15	0.5	30,000	90	0.004~0.008	30,000	90	0.004~0.007	30,000	80	0.003~0.006	30,000	70	0.003~0.005	30,000	50	0.003~0.004
		0.75	28,700	90	0.003~0.008	28,700	90	0.003~0.007	28,700	80	0.002~0.006	28,700	70	0.002~0.005	28,700	50	0.002~0.004
		1	27,300	80	0.002~0.006	27,300	80	0.002~0.006	27,300	70	0.001~0.005	27,300	60	0.001~0.004	27,300	40	0.001~0.003
2002	0.2	0.5	43,000	130	0.005~0.011	43,000	130	0.005~0.009	41,000	110	0.004~0.008	39,000	90	0.003~0.006	39,000	40	0.002~0.004
		1	34,000	100	0.005~0.01	34,000	100	0.005~0.008	32,000	80	0.004~0.007	30,000	70	0.003~0.006	30,000	30	0.002~0.004
		1.5	27,000	80	0.002~0.005	27,000	80	0.002~0.004	24,000	60	0.002~0.003	23,000	50	0.001~0.003	23,000	20	0.001~0.002
		2	21,900	20	0.002~0.004	21,900	20	0.001~0.002	21,900	15	0.001~0.002	21,900	10	0.001~0.002	21,900	10	0.001
		3	16,500	10	0.001~0.003	16,500	10	0.001~0.002	16,500	8	0.001~0.002	16,500	5	0.001~0.002	16,500	5	0.001
		3	31,000	280	0.002~0.004	31,000	240	0.002~0.003	31,000	210	0.001~0.003	31,000	190	0.001~0.002	31,000	160	0.001~0.002
2003	0.3	1	49,000	520	0.007~0.016	49,000	440	0.007~0.013	49,000	390	0.007~0.011	49,000	350	0.005~0.009	38,000	230	0.003~0.006
		1.5	43,000	425	0.005~0.012	43,000	360	0.005~0.01	43,000	320	0.005~0.008	43,000	285	0.004~0.007	37,500	210	0.002~0.004
		2	37,000	330	0.003~0.007	37,000	280	0.003~0.006	37,000	250	0.003~0.005	37,000	220	0.002~0.004	37,000	190	0.001~0.003
		3	31,000	280	0.002~0.004	31,000	240	0.002~0.003	31,000	210	0.001~0.003	31,000	190	0.001~0.002	31,000	160	0.001~0.002
2004	0.4	2	47,000	720	0.01~0.02	47,000	600	0.01~0.017	47,000	560	0.009~0.015	42,000	410	0.007~0.012	30,000	250	0.005~0.008
		3	47,000	630	0.005~0.01	47,000	530	0.005~0.008	47,000	470	0.004~0.007	40,000	350	0.003~0.006	30,000	220	0.002~0.004
		4	39,000	520	0.002~0.005	39,000	440	0.002~0.004	37,000	370	0.002~0.004	31,000	270	0.002~0.003	30,000	220	0.001~0.002
		5	38,000	440	0.002~0.005	38,000	370	0.002~0.004	32,000	280	0.002~0.003	29,000	220	0.001~0.003	28,000	180	0.001~0.002
		8	25,000	360	0.002~0.004	25,000	300	0.002~0.003	21,000	220	0.001~0.003	19,000	180	0.001~0.002	18,000	140	0.001~0.002
2005	0.5	2	47,000	900	0.014~0.028	47,000	750	0.014~0.023	43,000	610	0.012~0.021	38,000	460	0.009~0.016	25,000	260	0.004~0.007
		4	43,000	750	0.008~0.017	43,000	630	0.008~0.014	40,000	520	0.007~0.013	28,000	320	0.006~0.01	24,000	230	0.002~0.004
		6	31,000	460	0.004~0.008	31,000	390	0.004~0.007	26,000	290	0.003~0.006	24,000	230	0.002~0.004	23,000	190	0.002~0.003
		8	25,000	360	0.002~0.004	25,000	300	0.002~0.003	21,000	220	0.001~0.003	19,000	180	0.001~0.002	18,000	140	0.001~0.002
2006	0.6	2	46,000	1,050	0.018~0.036	46,000	880	0.018~0.03	40,000	670	0.016~0.027	32,000	470	0.012~0.021	21,000	270	0.009~0.015
		4	41,000	790	0.01~0.02	41,000	660	0.01~0.017	34,000	520	0.009~0.016	27,000	360	0.007~0.012	20,000	230	0.005~0.008
		6	31,000	600	0.005~0.011	31,000	500	0.005~0.009	26,000	370	0.005~0.008	21,000	260	0.003~0.006	20,000	210	0.002~0.004
		8	23,000	360	0.002~0.005	23,000	300	0.002~0.004	19,000	220	0.002~0.003	18,000	180	0.001~0.002	16,000	140	0.001~0.002
		10	21,000	330	0.002~0.005	21,000	280	0.002~0.004	17,000	200	0.002~0.003	16,000	160	0.001~0.002	15,000	130	0.001~0.002

- φ3mm Shank V Series
- UDC-PCD Series
- CBN Series
- Square
- Long Neck Square
- Radius
- Long Neck Radius
- Taper Neck Radius
- Ball / Long Shank Ball
- Long Neck Ball
- Taper Neck Ball
- Taper
- Barrel
- Spiral V Cutter
- Drill
- Technical Data

Milling Conditions for C-CER

WORK MATERIAL			COPPER OFC / TPC			CARBON STEELS S45C / S50C (~225HB)			ALLOY STEELS SK / SCM / SUS (225~325HB)			PREHARDENED STEELS HARDENED STEELS NAK / SKD (30~45HRC)			HARDENED STEELS SKD / SKT (45~50HRC)		
Model Number	Outside Diameter (mm)	Effective Length (mm)	Spindle Speed (min ⁻¹)	Feed Rate (mm/min)	a _p Axial Depth (mm)	Spindle Speed (min ⁻¹)	Feed Rate (mm/min)	a _p Axial Depth (mm)	Spindle Speed (min ⁻¹)	Feed Rate (mm/min)	a _p Axial Depth (mm)	Spindle Speed (min ⁻¹)	Feed Rate (mm/min)	a _p Axial Depth (mm)	Spindle Speed (min ⁻¹)	Feed Rate (mm/min)	a _p Axial Depth (mm)
2007	0.7	2	40,000	1,050	0.026~0.053	40,000	880	0.026~0.044	34,000	670	0.023~0.039	27,000	480	0.018~0.03	18,000	270	0.013~0.022
		3	40,000	1,050	0.022~0.044	40,000	880	0.022~0.037	34,000	670	0.02~0.033	27,000	470	0.015~0.026	18,000	270	0.011~0.018
		4	35,000	810	0.012~0.024	35,000	680	0.012~0.02	29,000	510	0.01~0.018	23,000	350	0.008~0.014	17,000	230	0.006~0.01
		6	27,000	620	0.006~0.013	27,000	520	0.006~0.011	22,000	380	0.005~0.009	18,000	270	0.004~0.007	17,000	220	0.003~0.005
		8	22,000	460	0.005~0.011	22,000	390	0.005~0.009	18,000	290	0.005~0.008	17,000	240	0.003~0.006	16,000	190	0.002~0.004
		10	20,000	360	0.002~0.005	20,000	300	0.002~0.004	16,000	220	0.002~0.004	15,000	180	0.001~0.003	14,000	140	0.001~0.002
2008	0.8	4	35,000	1,050	0.027~0.054	35,000	880	0.027~0.045	30,000	670	0.024~0.04	24,000	470	0.019~0.031	16,000	270	0.013~0.022
		6	31,000	820	0.013~0.028	31,000	690	0.013~0.023	25,000	510	0.012~0.02	20,000	350	0.009~0.016	15,000	220	0.006~0.011
		8	23,000	630	0.007~0.014	23,000	530	0.007~0.012	19,000	390	0.006~0.011	15,000	270	0.005~0.008	15,000	220	0.003~0.006
		10	19,000	450	0.006~0.012	19,000	380	0.006~0.01	16,000	280	0.005~0.009	15,000	230	0.004~0.007	14,000	180	0.003~0.005
		12	17,000	360	0.003~0.006	17,000	300	0.003~0.005	14,000	220	0.002~0.004	13,000	180	0.002~0.003	12,000	140	0.001~0.002
2009	0.9	4	31,000	1,090	0.028~0.058	31,000	910	0.028~0.048	26,000	690	0.026~0.043	21,000	480	0.02~0.033	14,000	270	0.014~0.024
		6	27,000	840	0.014~0.029	27,000	700	0.014~0.024	22,000	510	0.013~0.022	18,000	360	0.01~0.017	13,000	230	0.007~0.012
		8	21,000	640	0.008~0.016	21,000	540	0.008~0.013	17,000	400	0.007~0.012	14,000	280	0.005~0.009	13,000	230	0.004~0.006
		10	17,000	460	0.006~0.013	17,000	390	0.006~0.011	14,000	290	0.006~0.01	13,000	230	0.004~0.007	12,000	190	0.003~0.005
		15	11,000	320	0.003~0.006	11,000	270	0.003~0.005	13,000	200	0.003~0.005	12,000	160	0.002~0.003	11,000	130	0.001~0.002
2010	1	4	28,000	1,120	0.03~0.06	28,000	940	0.03~0.05	23,000	710	0.027~0.045	19,000	490	0.021~0.035	12,700	280	0.015~0.025
		6	24,000	850	0.015~0.03	24,000	710	0.015~0.025	20,000	520	0.013~0.023	16,000	360	0.01~0.017	12,000	230	0.007~0.012
		8	24,000	850	0.015~0.03	24,000	710	0.015~0.025	20,000	520	0.013~0.023	16,000	360	0.01~0.017	12,000	230	0.007~0.012
		10	19,000	640	0.008~0.017	19,000	540	0.008~0.014	15,000	400	0.007~0.012	12,000	280	0.005~0.009	12,000	230	0.004~0.007
		12	15,000	460	0.007~0.014	15,000	390	0.007~0.012	13,000	290	0.006~0.01	12,000	230	0.005~0.008	11,400	190	0.003~0.006
		16	12,000	360	0.003~0.007	12,000	300	0.003~0.006	10,500	220	0.003~0.005	9,700	180	0.002~0.004	9,100	140	0.001~0.003
		20	10,000	320	0.003~0.007	10,000	270	0.003~0.006	8,400	200	0.003~0.005	7,700	160	0.002~0.004	7,300	130	0.001~0.003
2012	1.2	6	23,000	1,050	0.036~0.072	23,000	880	0.036~0.06	20,000	670	0.032~0.054	16,000	470	0.025~0.042	10,000	260	0.018~0.03
		8	20,000	820	0.018~0.036	20,000	690	0.018~0.03	16,000	500	0.016~0.027	13,000	350	0.012~0.021	10,000	220	0.009~0.015
		10	15,000	630	0.01~0.019	15,000	530	0.01~0.016	13,000	390	0.009~0.015	10,600	270	0.007~0.011	10,000	220	0.005~0.008
		12	15,000	630	0.01~0.019	15,000	530	0.01~0.016	13,000	390	0.009~0.015	10,600	270	0.007~0.011	10,000	220	0.005~0.008
		16	11,000	320	0.004~0.008	11,000	270	0.004~0.007	9,000	200	0.003~0.006	9,000	160	0.003~0.005	8,400	130	0.002~0.003

Ø3mm Shank
V SeriesUDC-PCD
SeriesCBN
Series

Square

Square
Long Neck
Square

Radius

Radius

Long Neck
RadiusTaper Neck
Radius

Ball

Ball / Long
Shank BallLong Neck
BallTaper Neck
Ball

Taper

Taper

Barrel

Spiral
V Cutter

Drill

Technical Data

Milling Conditions for C-CER

WORK MATERIAL		COPPER OFC / TPC			CARBON STEELS S45C / S50C (~225HB)			ALLOY STEELS SK / SCM / SUS (225~325HB)			PREHARDENED STEELS HARDENED STEELS NAK / SKD (30~45HRC)			HARDENED STEELS SKD / SKT (45~50HRC)			
Model Number	Outside Diameter (mm)	Effective Length (mm)	Spindle Speed (min ⁻¹)	Feed Rate (mm/min)	a _p Axial Depth (mm)	Spindle Speed (min ⁻¹)	Feed Rate (mm/min)	a _p Axial Depth (mm)	Spindle Speed (min ⁻¹)	Feed Rate (mm/min)	a _p Axial Depth (mm)	Spindle Speed (min ⁻¹)	Feed Rate (mm/min)	a _p Axial Depth (mm)	Spindle Speed (min ⁻¹)	Feed Rate (mm/min)	a _p Axial Depth (mm)
2014	1.4	6	20,000	1,000	0.042~0.084	20,000	840	0.042~0.07	17,000	640	0.038~0.063	13,000	440	0.029~0.049	9,000	250	0.021~0.035
		8	17,000	790	0.021~0.042	17,000	660	0.021~0.035	14,000	480	0.019~0.032	11,500	330	0.015~0.025	8,600	210	0.01~0.017
		10	17,000	790	0.021~0.042	17,000	660	0.021~0.035	14,000	480	0.019~0.032	11,500	330	0.015~0.025	8,600	210	0.01~0.017
		12	13,000	620	0.011~0.023	13,000	520	0.011~0.019	11,000	380	0.01~0.017	9,000	270	0.008~0.013	8,600	220	0.005~0.009
		14	13,000	620	0.011~0.023	13,000	520	0.011~0.019	11,000	380	0.01~0.017	9,000	270	0.008~0.013	8,600	220	0.005~0.009
		16	11,000	430	0.01~0.02	11,000	360	0.01~0.017	9,000	270	0.009~0.015	8,000	220	0.007~0.011	8,100	180	0.005~0.008
		22	10,000	310	0.005~0.01	10,000	260	0.005~0.008	8,000	190	0.004~0.007	7,000	150	0.003~0.005	7,200	120	0.002~0.004
2015	1.5	6	18,000	1,030	0.045~0.09	18,000	860	0.045~0.075	15,000	650	0.04~0.068	12,000	460	0.031~0.052	8,400	260	0.022~0.037
		8	16,000	810	0.023~0.046	16,000	680	0.023~0.038	13,000	500	0.02~0.034	10,000	340	0.016~0.026	8,000	220	0.011~0.019
		10	16,000	810	0.023~0.046	16,000	680	0.023~0.038	13,000	500	0.02~0.034	10,000	340	0.016~0.026	8,000	220	0.011~0.019
		12	16,000	810	0.023~0.046	16,000	680	0.023~0.038	13,000	500	0.02~0.034	10,000	340	0.016~0.026	8,000	220	0.011~0.019
		14	12,700	620	0.012~0.025	12,700	520	0.012~0.021	10,600	390	0.011~0.018	8,400	270	0.008~0.014	8,000	220	0.006~0.01
		16	10,300	450	0.01~0.022	10,300	380	0.01~0.018	8,600	280	0.009~0.016	8,000	230	0.007~0.012	7,600	180	0.005~0.009
		18	10,300	450	0.01~0.022	10,300	380	0.01~0.018	8,600	280	0.009~0.016	8,000	230	0.007~0.012	7,600	180	0.005~0.009
2016	1.6	20	9,000	320	0.005~0.011	9,000	270	0.005~0.009	7,000	200	0.004~0.008	7,200	160	0.003~0.006	6,700	130	0.002~0.004
		6	17,000	1,050	0.048~0.096	17,000	880	0.048~0.08	14,000	670	0.043~0.072	11,900	470	0.033~0.056	7,900	260	0.024~0.04
		8	17,000	1,050	0.048~0.096	17,000	880	0.048~0.08	14,000	670	0.043~0.072	11,900	470	0.033~0.056	7,900	260	0.024~0.04
		10	15,000	820	0.024~0.048	15,000	690	0.024~0.04	12,700	500	0.022~0.036	10,100	350	0.017~0.028	7,500	220	0.012~0.02
		12	15,000	820	0.024~0.048	15,000	690	0.024~0.04	12,700	500	0.022~0.036	10,100	350	0.017~0.028	7,500	220	0.012~0.02
		14	11,900	630	0.013~0.026	11,900	530	0.013~0.022	9,900	390	0.012~0.02	7,900	270	0.009~0.015	7,500	220	0.006~0.011
		16	11,900	630	0.013~0.026	11,900	530	0.013~0.022	9,900	390	0.012~0.02	7,900	270	0.009~0.015	7,500	220	0.006~0.011
		18	9,700	460	0.011~0.023	9,700	390	0.011~0.019	8,100	290	0.01~0.017	7,500	230	0.008~0.013	7,100	190	0.005~0.009
2018	1.8	20	9,000	450	0.011~0.023	9,000	380	0.011~0.019	8,100	280	0.01~0.017	7,500	230	0.008~0.013	7,100	180	0.005~0.009
		26	8,000	280	0.005~0.011	8,000	240	0.005~0.009	7,300	180	0.005~0.008	6,700	140	0.004~0.006	6,300	120	0.002~0.004
		6	15,000	1,030	0.051~0.102	15,000	860	0.051~0.085	13,200	650	0.045~0.076	10,600	460	0.035~0.059	7,000	260	0.025~0.042
		8	15,000	1,030	0.051~0.102	15,000	860	0.051~0.085	13,200	650	0.045~0.076	10,600	460	0.035~0.059	7,000	260	0.025~0.042
		10	13,700	810	0.027~0.055	13,700	680	0.027~0.046	11,400	500	0.024~0.041	9,000	340	0.019~0.032	6,700	220	0.013~0.023
		12	13,700	810	0.027~0.055	13,700	680	0.027~0.046	11,400	500	0.024~0.041	9,000	340	0.019~0.032	6,700	220	0.013~0.023
		14	13,700	810	0.027~0.055	13,700	680	0.027~0.046	11,400	500	0.024~0.041	9,000	340	0.019~0.032	6,700	220	0.013~0.023
		16	10,600	620	0.015~0.03	10,600	520	0.015~0.025	8,800	380	0.013~0.022	7,000	270	0.01~0.017	6,700	220	0.007~0.012
		18	10,600	620	0.015~0.03	10,600	520	0.015~0.025	8,800	380	0.013~0.022	7,000	270	0.01~0.017	6,700	220	0.007~0.012
		20	8,600	450	0.012~0.024	8,600	380	0.012~0.02	7,200	280	0.01~0.018	6,700	230	0.008~0.014	6,300	180	0.006~0.01
25	7,700	310	0.006~0.012	7,700	260	0.006~0.01	6,500	200	0.005~0.009	6,000	160	0.004~0.007	5,600	130	0.003~0.005		

Milling Conditions for C-CER

WORK MATERIAL			COPPER OFC / TPC				CARBON STEELS S45C / S50C (~225HB)			ALLOY STEELS SK / SCM / SUS (225~325HB)			PREHARDENED STEELS HARDENED STEELS NAK / SKD (30~45HRC)			HARDENED STEELS SKD / SKT (45~50HRC)		
Model Number	Outside Diameter (mm)	Effective Length (mm)	Spindle Speed (min ⁻¹)	Feed Rate (mm/min)	a _p Axial Depth (mm)	Spindle Speed (min ⁻¹)	Feed Rate (mm/min)	a _p Axial Depth (mm)	Spindle Speed (min ⁻¹)	Feed Rate (mm/min)	a _p Axial Depth (mm)	Spindle Speed (min ⁻¹)	Feed Rate (mm/min)	a _p Axial Depth (mm)	Spindle Speed (min ⁻¹)	Feed Rate (mm/min)	a _p Axial Depth (mm)	
2020	2	6	14,000	1,080	0.058~0.118	14,000	900	0.058~0.098	12,000	680	0.052~0.088	9,600	480	0.041~0.068	6,400	270	0.029~0.049	
		8	14,000	1,020	0.052~0.106	14,000	850	0.052~0.088	12,000	650	0.047~0.079	9,600	450	0.037~0.061	6,400	260	0.026~0.044	
		10	14,000	1,020	0.052~0.106	14,000	850	0.052~0.088	12,000	650	0.047~0.079	9,600	450	0.037~0.061	6,400	260	0.026~0.044	
		12	12,300	790	0.026~0.053	12,300	660	0.026~0.044	10,400	500	0.024~0.04	8,100	340	0.018~0.031	6,000	220	0.013~0.022	
		14	12,300	790	0.026~0.053	12,300	660	0.026~0.044	10,400	500	0.024~0.04	8,100	340	0.018~0.031	6,000	220	0.013~0.022	
		16	12,300	790	0.026~0.053	12,300	660	0.026~0.044	10,400	500	0.024~0.04	8,100	340	0.018~0.031	6,000	220	0.013~0.022	
		18	9,500	610	0.014~0.029	9,500	510	0.014~0.024	7,900	380	0.013~0.022	6,300	270	0.01~0.017	6,000	220	0.007~0.012	
		20	9,500	610	0.014~0.029	9,500	510	0.014~0.024	7,900	380	0.013~0.022	6,300	270	0.01~0.017	6,000	220	0.007~0.012	
		25	7,700	430	0.012~0.025	7,700	360	0.012~0.021	6,400	270	0.011~0.018	6,000	220	0.008~0.014	5,700	180	0.006~0.01	
		30	7,000	310	0.006~0.012	7,000	260	0.006~0.01	5,800	190	0.005~0.009	5,400	150	0.004~0.007	5,000	120	0.003~0.005	
2025	2.5	8	10,800	1,390	0.066~0.132	10,800	1,160	0.066~0.11	9,100	880	0.059~0.099	7,600	640	0.046~0.077	5,100	360	0.033~0.055	
		10	10,800	1,390	0.066~0.132	10,800	1,160	0.066~0.11	9,100	880	0.059~0.099	7,600	640	0.046~0.077	5,100	360	0.033~0.055	
		12	10,800	1,390	0.066~0.132	10,800	1,160	0.066~0.11	9,100	880	0.059~0.099	7,600	640	0.046~0.077	5,100	360	0.033~0.055	
		14	9,500	1,090	0.033~0.067	9,500	910	0.033~0.056	8,000	680	0.03~0.05	6,500	490	0.023~0.039	4,800	310	0.016~0.028	
		16	9,500	1,090	0.033~0.067	9,500	910	0.033~0.056	8,000	680	0.03~0.05	6,500	490	0.023~0.039	4,800	310	0.016~0.028	
		18	9,500	1,090	0.033~0.067	9,500	910	0.033~0.056	8,000	680	0.03~0.05	6,500	490	0.023~0.039	4,800	310	0.016~0.028	
		20	9,500	1,090	0.033~0.067	9,500	910	0.033~0.056	8,000	680	0.03~0.05	6,500	490	0.023~0.039	4,800	310	0.016~0.028	
		25	7,600	820	0.018~0.036	7,600	690	0.018~0.03	6,300	510	0.016~0.027	5,000	360	0.012~0.021	4,800	290	0.009~0.015	
		30	6,200	480	0.014~0.029	6,200	400	0.014~0.024	5,200	300	0.013~0.022	4,800	240	0.01~0.017	4,500	200	0.007~0.012	
2030	3	8	8,700	1,580	0.088~0.176	8,700	1,320	0.088~0.147	7,300	990	0.079~0.132	5,900	700	0.055~0.092	4,200	420	0.044~0.073	
		10	8,700	1,500	0.079~0.158	8,700	1,250	0.079~0.132	7,300	940	0.071~0.119	5,900	660	0.055~0.092	4,200	400	0.039~0.066	
		12	8,700	1,500	0.079~0.158	8,700	1,250	0.079~0.132	7,300	940	0.071~0.119	5,900	660	0.055~0.092	4,200	400	0.039~0.066	
		14	8,700	1,500	0.079~0.158	8,700	1,250	0.079~0.132	7,300	940	0.071~0.119	5,900	660	0.055~0.092	4,200	400	0.039~0.066	
		16	7,600	1,160	0.04~0.08	7,600	970	0.04~0.067	6,300	720	0.036~0.06	5,000	500	0.028~0.047	3,900	340	0.02~0.033	
		18	7,600	1,160	0.04~0.08	7,600	970	0.04~0.067	6,300	720	0.036~0.06	5,000	500	0.028~0.047	3,900	340	0.02~0.033	
		20	7,600	1,160	0.04~0.08	7,600	970	0.04~0.067	6,300	720	0.036~0.06	5,000	500	0.028~0.047	3,900	340	0.02~0.033	
		25	6,300	970	0.022~0.043	6,300	810	0.022~0.036	5,300	600	0.019~0.033	4,200	420	0.015~0.025	3,900	340	0.011~0.018	
		30	6,300	970	0.022~0.043	6,300	810	0.022~0.036	5,300	600	0.019~0.033	4,200	420	0.015~0.025	3,900	340	0.011~0.018	
		35	5,100	490	0.017~0.035	5,100	410	0.017~0.029	4,300	300	0.016~0.026	4,000	240	0.012~0.02	3,800	200	0.008~0.014	
		40	4,600	310	0.007~0.014	4,600	260	0.007~0.012	3,900	200	0.006~0.01	3,600	160	0.005~0.008	3,300	130	0.003~0.006	

Ø3mm Shank
V SeriesUDC-PCD
SeriesCBN
SeriesSquare
Long Neck
Square

Radius

Long Neck
RadiusTaper Neck
RadiusBall / Long
Shank BallLong Neck
BallTaper Neck
Ball

Taper

Barrel

Spiral
V Cutter

Drill

Technical Data

Milling Conditions for C-CER

WORK MATERIAL			COPPER OFC / TPC			CARBON STEELS S45C / S50C (~225HB)			ALLOY STEELS SK / SCM / SUS (225~325HB)			PREHARDENED STEELS HARDENED STEELS NAK / SKD (30~45HRC)			HARDENED STEELS SKD / SKT (45~50HRC)		
Model Number	Outside Diameter (mm)	Effective Length (mm)	Spindle Speed (min ⁻¹)	Feed Rate (mm/min)	a _p Axial Depth (mm)	Spindle Speed (min ⁻¹)	Feed Rate (mm/min)	a _p Axial Depth (mm)	Spindle Speed (min ⁻¹)	Feed Rate (mm/min)	a _p Axial Depth (mm)	Spindle Speed (min ⁻¹)	Feed Rate (mm/min)	a _p Axial Depth (mm)	Spindle Speed (min ⁻¹)	Feed Rate (mm/min)	a _p Axial Depth (mm)
2035	3.5	12	7,100	1,280	0.092~0.185	7,100	1,070	0.092~0.154	6,000	790	0.083~0.138	4,800	560	0.064~0.108	3,300	330	0.046~0.077
		15	7,100	1,280	0.092~0.185	7,100	1,070	0.092~0.154	6,000	790	0.083~0.138	4,800	560	0.064~0.108	3,300	330	0.046~0.077
		16	7,100	1,280	0.092~0.185	7,100	1,070	0.092~0.154	6,000	790	0.083~0.138	4,800	560	0.064~0.108	3,300	330	0.046~0.077
		20	6,200	990	0.043~0.086	6,200	830	0.043~0.072	5,100	610	0.039~0.065	4,000	420	0.03~0.05	3,100	280	0.021~0.036
		25	6,200	990	0.043~0.086	6,200	830	0.043~0.072	5,100	610	0.039~0.065	4,000	420	0.03~0.05	3,100	280	0.021~0.036
		30	5,000	800	0.025~0.05	5,000	670	0.025~0.042	4,200	500	0.023~0.038	3,300	340	0.018~0.03	3,100	280	0.012~0.021
		35	5,000	800	0.025~0.05	5,000	670	0.025~0.042	4,200	500	0.023~0.038	3,300	340	0.018~0.03	3,100	280	0.012~0.021
2040	4	12	6,000	1,170	0.1~0.202	6,000	980	0.1~0.168	5,000	720	0.09~0.151	3,900	500	0.07~0.117	2,700	290	0.05~0.084
		16	6,000	1,110	0.09~0.181	6,000	930	0.09~0.151	5,000	690	0.081~0.136	3,900	480	0.063~0.105	2,700	280	0.045~0.075
		20	6,000	1,110	0.09~0.181	6,000	930	0.09~0.151	5,000	690	0.081~0.136	3,900	480	0.063~0.105	2,700	280	0.045~0.075
		25	5,200	860	0.046~0.091	5,200	720	0.046~0.076	4,200	520	0.041~0.069	3,300	350	0.032~0.053	2,500	230	0.023~0.038
		30	5,200	860	0.046~0.091	5,200	720	0.046~0.076	4,200	520	0.041~0.069	3,300	350	0.032~0.053	2,500	230	0.023~0.038
		35	4,200	660	0.025~0.05	4,200	550	0.025~0.042	3,500	400	0.022~0.037	2,700	270	0.017~0.029	2,500	220	0.012~0.021
		40	4,200	660	0.025~0.05	4,200	550	0.025~0.042	3,500	400	0.022~0.037	2,700	270	0.017~0.029	2,500	220	0.012~0.021
		45	3,400	430	0.018~0.037	3,400	360	0.018~0.031	2,800	270	0.016~0.028	2,500	210	0.013~0.021	2,300	160	0.009~0.015
		50	3,400	380	0.018~0.037	3,400	320	0.018~0.031	2,800	240	0.016~0.028	2,500	190	0.013~0.021	2,300	140	0.009~0.015
2050	5	16	4,400	870	0.113~0.227	4,400	730	0.113~0.189	3,600	530	0.102~0.17	2,800	360	0.079~0.132	1,700	190	0.056~0.094
		20	4,400	870	0.113~0.227	4,400	730	0.113~0.189	3,600	530	0.102~0.17	2,800	360	0.079~0.132	1,700	190	0.056~0.094
		25	4,400	870	0.113~0.227	4,400	730	0.113~0.189	3,600	530	0.102~0.17	2,800	360	0.079~0.132	1,700	190	0.056~0.094
		30	3,800	630	0.057~0.115	3,800	530	0.057~0.096	3,000	380	0.051~0.086	2,200	240	0.04~0.067	1,600	150	0.028~0.048
		35	3,800	630	0.057~0.115	3,800	530	0.057~0.096	3,000	380	0.051~0.086	2,200	240	0.04~0.067	1,600	150	0.028~0.048
		40	3,800	630	0.057~0.115	3,800	530	0.057~0.096	3,000	380	0.051~0.086	2,200	240	0.022~0.036	1,600	150	0.028~0.048
		50	2,900	460	0.031~0.062	2,900	390	0.031~0.052	2,400	280	0.028~0.047	1,700	180	0.022~0.036	1,600	140	0.015~0.026
2060	6	20	3,300	670	0.113~0.227	3,300	560	0.113~0.189	2,700	400	0.102~0.17	2,000	260	0.079~0.132	1,100	130	0.056~0.094
		30	3,300	670	0.113~0.227	3,300	560	0.113~0.189	2,700	400	0.102~0.17	2,000	260	0.079~0.132	1,100	130	0.056~0.094
		40	2,800	480	0.057~0.115	2,800	400	0.057~0.096	2,200	270	0.051~0.086	1,500	170	0.04~0.067	1,000	100	0.028~0.048
		50	2,100	330	0.031~0.062	2,100	280	0.031~0.052	1,600	200	0.028~0.047	1,100	120	0.022~0.036	1,000	90	0.015~0.026
		60	2,100	330	0.031~0.062	2,100	280	0.031~0.052	1,600	200	0.028~0.047	1,100	120	0.022~0.036	1,000	90	0.015~0.026

Slotting

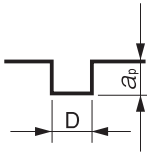

D : Outside Diameter (mm)

Note:

- Decrease both spindle speed and feed rate proportionally when the milling parameters exceed the machine's maximum spindle speed.
- Recommend water soluble or oil coolant.
- Recommend oil coolant for Titanium Alloys and Heat Resistant Alloys.

Ø3mm Shank
V Series

UDC-PCD
Series

CBN
Series

Square

Square

Long Neck
Square

Radius

Radius

Long Neck
Radius

Taper Neck
Radius

Ball

Ball / Long
Shank Ball

Long Neck
Ball

Taper Neck
Ball

Taper

Taper

Barrel

Spiral

V Cutter

Drill

Technical Data



Size $\phi 0.4 \sim \phi 6$

DCLS



Material Applications (★ Highly Recommended ● Recommended ○ Suggested)

Work Material																	
Carbon Steels S45C S55C	Alloy Steels SK / SCM SUS	Prehardened Steels NAK HPM	Hardened Steels					Cast Iron	Aluminum Alloys	Graphite	Copper	Plastics	Glass Filled Plastics	Titanium Alloys	Heat Resistant Alloys	Cemented Carbide	Hard Brittle (Non-Metallic) Materials
			~50HRC	~55HRC	~60HRC	~65HRC	~70HRC										
									○	★	○	○	●				○

Features

2 Flute Diamond coated Long Neck Square End Mills for milling Graphite Electrodes. New diamond coating, with a highly adhesive base layer, offers excellent wear resistance and long tool life.

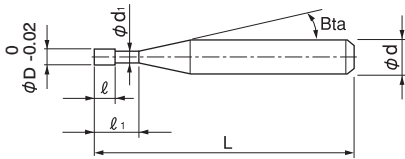

The shank taper angle shown is not an exact value and to avoid contact with the work piece, we recommend the user controls the precise value of this angle. Shank taper angle should not make contact with the work piece.

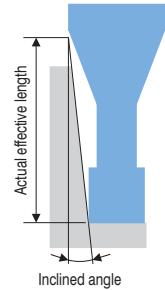

Total 45 models

Unit (mm)

Model Number	Outside Diameter ϕD	Effective Length ℓ_1	Length of Cut ℓ	Neck Diameter ϕd_1	Shank Taper Angle Bta	Overall Length L	Shank Diameter ϕd	Suggested Retail Price ¥	Effective Length by Inclined Angles				
									30'	1°	1° 30'	2°	3°
DCLS 2004-020	0.4	2	0.8	0.37	16°	45	4	16,000	2.26	2.43	2.57	2.68	2.89
DCLS 2004-040		4							4.40	4.63	4.80	4.97	5.34
DCLS 2004-060		6							6.51	6.77	7.00	7.24	7.79
DCLS 2005-020	0.5	2	1	0.47	16°	45	4	16,000	2.32	2.52	2.68	2.82	3.07
DCLS 2005-040		4							4.48	4.74	4.95	5.13	5.51
DCLS 2005-060		6							6.60	6.91	7.15	7.40	7.96
DCLS 2006-020	0.6	2	1.2	0.57	16°	45	4	16,000	2.36	2.60	2.78	2.95	3.23
DCLS 2006-040		4							4.55	4.85	5.08	5.29	5.68
DCLS 2006-060		6							6.69	7.04	7.31	7.56	8.13
DCLS 2006-080		8							8.80	9.19	9.51	9.84	10.58
DCLS 2006-100		10				45	4	16,000	10.90	11.33	11.71	12.12	13.03

Unit (mm)

Model Number	Outside Diameter ϕD	Effective Length ℓ_1	Length of Cut ℓ	Neck Diameter ϕd_1	Shank Taper Angle Bta	Overall Length L	Shank Diameter ϕd	Suggested Retail Price ¥	Effective Length by Inclined Angles				
									30'	1°	1° 30'	2°	3°
DCLS 2007-040	0.7	4	1.4	0.67	16°	45	4	16,000	4.55	4.85	5.08	5.29	5.68
DCLS 2007-060		6				45	4	16,000	6.69	7.04	7.31	7.56	8.13
DCLS 2007-080		8				45	4	16,000	8.80	9.19	9.51	9.84	10.58
DCLS 2007-100		10				45	4	16,000	10.90	11.33	11.71	12.12	13.03
DCLS 2008-040	0.8	4	1.6	0.77	16°	45	4	16,000	4.55	4.85	5.08	5.29	5.68
DCLS 2008-060		6				45	4	16,000	6.69	7.04	7.31	7.56	8.13
DCLS 2008-080		8				45	4	16,000	8.80	9.19	9.51	9.84	10.58
DCLS 2008-100		10				45	4	16,000	10.90	11.33	11.71	12.12	13.03
DCLS 2010-040	1	4	2	0.96	16°	45	4	16,000	4.57	4.86	5.09	5.30	5.70
DCLS 2010-060		6				45	4	16,000	6.70	7.05	7.32	7.57	8.14
DCLS 2010-080		8				45	4	16,000	8.82	9.20	9.52	9.85	10.59
DCLS 2010-100		10				45	4	16,000	10.91	11.34	11.72	12.13	13.04
DCLS 2010-160		16				50	4	16,000	17.16	17.73	18.32	18.96	20.38
DCLS 2010-210		21				55	4	16,000	22.33	23.05	23.82	24.65	26.50
DCLS 2015-060	1.5	6	3	1.44	16°	45	4	16,000	6.17	6.37	6.58	6.81	7.33
DCLS 2015-100		10				45	4	16,000	10.29	10.63	10.98	11.37	12.22
DCLS 2015-160		16				50	4	16,000	16.48	17.02	17.59	18.20	19.56
DCLS 2015-210		21				55	4	16,000	21.64	22.34	23.09	23.89	No Interference
DCLS 2020-060	2	6	4	1.9	16°	50	4	16,000	6.22	6.42	6.64	6.87	7.39
DCLS 2020-100		10				50	4	16,000	10.35	10.68	11.04	11.43	12.28
DCLS 2020-160		16				50	4	16,000	16.53	17.07	17.65	18.26	No Interference
DCLS 2020-210		21				55	4	16,000	21.69	22.40	23.15	23.95	No Interference
DCLS 2020-260		26				55	4	16,000	26.85	27.72	28.65	No Interference	No Interference
DCLS 2030-160	3	16	6	2.9	16°	70	6	18,000	16.53	17.07	17.65	18.26	19.63
DCLS 2030-210		21				70	6	20,000	21.69	22.40	23.15	23.95	25.74
DCLS 2030-260		26				70	6	20,000	26.85	27.72	28.65	29.65	No Interference
DCLS 2030-320		32				80	6	20,000	33.04	34.11	35.25	36.48	No Interference
DCLS 2040-210	4	21	8	3.91	16°	70	6	20,000	21.68	22.39	23.14	23.94	No Interference
DCLS 2040-260		26				70	6	20,000	26.84	27.71	28.64	No Interference	No Interference
DCLS 2040-320		32				70	6	20,000	33.03	34.10	35.24	No Interference	No Interference
DCLS 2040-420		42				80	6	23,000	43.34	44.75	No Interference	No Interference	No Interference
DCLS 2060-320	6	32	12	5.71	—	80	6	23,000	No Interference	No Interference	No Interference	No Interference	No Interference
DCLS 2060-420		42				80	6	23,000	No Interference	No Interference	No Interference	No Interference	No Interference
DCLS 2060-630		63				120	6	30,000	No Interference	No Interference	No Interference	No Interference	No Interference

Ø3mm Shank
V SeriesUDC-PCD
SeriesCBN
SeriesSquare
Long Neck
SquareRadius
Long Neck
RadiusTaper Neck
RadiusBall / Long
Shank Ball
Long Neck
Ball

Taper

Barrel

Spiral
V Cutter

Drill

Technical Data

Milling Conditions for DCLS

WORK MATERIAL			GRAPHITE				
Model Number	Outside Diameter (mm)	Effective Length (mm)	Spindle Speed (min ⁻¹)	Feed Rate (mm/min)	Side Milling		Slotting
					a _D Axial Depth (mm)	a _e Radial Depth (mm)	a _D Axial Depth (mm)
2004-020	0.4	2	34,000	410	0.4	0.02	0.02
2004-040		4	34,000	240	0.4	0.02	0.02
2004-060		6	34,000	180	0.4	0.02	0.02
2005-020	0.5	2	34,000	540	0.5	0.025	0.025
2005-040		4	34,000	350	0.5	0.025	0.025
2005-060		6	34,000	240	0.5	0.025	0.025
2006-020	0.6	2	34,000	660	0.6	0.03	0.03
2006-040		4	34,000	520	0.6	0.03	0.03
2006-060		6	34,000	320	0.6	0.03	0.03
2006-080		8	25,000	220	0.6	0.03	0.03
2006-100	0.7	10	24,000	120	0.6	0.03	0.03
2007-040		4	34,000	600	0.7	0.035	0.035
2007-060		6	34,000	380	0.7	0.035	0.035
2007-080	0.7	8	25,000	260	0.7	0.035	0.035
2007-100		10	24,000	140	0.7	0.035	0.035
2008-040	0.8	4	34,000	690	0.8	0.04	0.04
2008-060		6	34,000	440	0.8	0.04	0.04
2008-080		8	25,000	300	0.8	0.04	0.04
2008-100		10	24,000	170	0.8	0.04	0.04
2010-040	1	4	34,000	1,170	1	0.05	0.1
2010-060		6	26,000	850	1	0.05	0.1
2010-080		8	22,000	660	1	0.05	0.1
2010-100		10	22,100	530	1	0.05	0.1
2010-160		16	14,300	300	1	0.05	0.1
2010-210	1.5	21	12,500	200	1	0.05	0.1
2015-060		6	22,000	1,620	1.5	0.075	0.15
2015-100		10	17,000	1,050	1.5	0.075	0.15
2015-160		16	15,000	600	1.5	0.075	0.15
2015-210		21	10,000	370	1.5	0.075	0.15
2020-060	2	6	25,500	2,175	2	0.1	0.2
2020-100		10	21,000	1,680	2	0.1	0.2
2020-160		16	19,500	1,230	2	0.1	0.2
2020-210		21	16,500	750	2	0.1	0.2
2020-260		26	12,000	590	2	0.1	0.2
2030-160	3	16	22,000	2,200	3	0.15	0.3
2030-210		21	20,000	1,800	3	0.15	0.3
2030-260		26	18,000	1,450	3	0.15	0.3
2030-320		32	15,000	1,040	3	0.15	0.3
2040-210	4	21	14,000	1,760	4	0.2	0.4
2040-260		26	13,500	1,450	4	0.2	0.4
2040-320		32	13,000	1,160	4	0.2	0.4
2040-420		42	11,000	900	4	0.2	0.4
2060-320	6	32	12,000	1,500	6	0.6	1.2
2060-420		42	10,800	1,160	6	0.6	1.2
2060-630		63	7,400	620	6	0.6	1.2

φ3mm Shank V Series

UDC-PCD Series

CBN Series

Square
Long Neck Square

Radius

Long Neck Radius
Taper Neck Radius

Ball / Long Shank Ball

Long Neck Ball
Taper Neck Ball

Taper

Barrel

Spiral V Cutter

Drill

Technical Data

Slotting

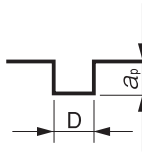

D : Outside Diameter (mm)

Side Milling

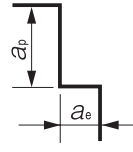

Note:

- Use a milling machine dedicated for Graphite.
- Recommend air blow for Graphite.

Other series for Graphite milling

Square / Long Neck Square

(★ Highly Recommended ● Recommended ○ Suggested)

Number of Flutes, Tool Type	Model Number	Appearance	Coating	Size	Aluminum Alloys	Graphite	Copper	Plastics	Glass Filled Plastics	Hard Brittle (Non-Metallic) Materials	Page
4 flutes Square	CGE		Non-coat	$\phi 2 \sim \phi 20$	○	★	○	○	○		236
2 flutes Square	DCES 2000		DIA	$\phi 0.2 \sim \phi 6$	○	★	○	○	●	○	188
4 flutes Square	DCES 4000		DIA	$\phi 3 \sim \phi 10$	○	★	○	○	●	○	234
2 flutes Long Neck Square	DCLS		DIA	$\phi 0.4 \sim \phi 6$	○	★	○	○	●	○	266

Long Neck Radius

4 flutes Long Neck Radius	DCLRS		DIA	$\phi 1 \sim \phi 6$	○	★	○	○	●	○	396
------------------------------	-------	--	-----	----------------------	---	---	---	---	---	---	-----

Ball / Long Neck Ball / Taper Neck Ball

2 flutes Ball	CGB 2000		Non-coat	R0.2~R6	○	★	○	○	○		440
4 flutes Ball	CGB 4000		Non-coat	R2~R10	○	★	○	○	○		458
2 flutes Ball	DCB		DIA	R0.5~R6	○	★	○	○	●	○	438
2 flutes Long Neck Ball	DCLB		DIA	R0.2~R3	○	★	○	○	●	○	512
2 flutes Taper Neck Ball	DCTNB		DIA	R0.5~R1	○	★	○	○	●	○	556

φ3mm Shank
V Series

UDC-PCD
Series

CBN
Series

Square

Long Neck
Square

Radius

Radius

Long Neck
Radius

Taper Neck
Radius

Ball / Long
Shank Ball

Long Neck
Ball

Taper Neck
Ball

Taper

Taper

Barrel

Spiral
V Cutter

Drill

Technical Data



Size $\phi 0.5 \sim \phi 6$

CPR



($\phi 0.5 \sim \phi 2.5$) ($\phi 3$ or above)

Material Applications (★ Highly Recommended ● Recommended ○ Suggested)

Work Material																	
Carbon Steels S45C S55C	Alloy Steels SK / SCM SUS	Prehardened Steels NAK HPM	Hardened Steels					Cast Iron	Aluminum Alloys	Graphite	Copper	Plastics	Glass Filled Plastics	Titanium Alloys	Heat Resistant Alloys	Cemented Carbide	Hard Brittle (Non-Metallic) Materials
			~50HRC	~55HRC	~60HRC	~65HRC	~70HRC										
											○	●	★				

Features

Long Neck Square End Mills for milling Plastics.
Designed especially for deep rib milling using an under cut design.

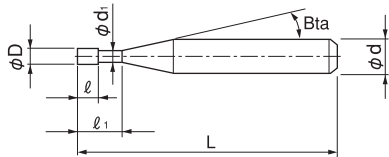

The shank taper angle shown is not an exact value and to avoid contact with the work piece, we recommend the user controls the precise value of this angle. Shank taper angle should not make contact with the work piece.

Total 64 models

Unit (mm)

Model Number	Outside Diameter ϕD	Effective Length ℓ_1	Length of Cut ℓ	Neck Diameter ϕd_1	Shank Taper Angle Bta	Overall Length L	Shank Diameter ϕd	Suggested Retail Price ¥
CPR 2005-2	0.5	2	1	0.45	11°	38	3	6,700
CPR 2005-4		4				38	3	6,700
CPR 2005-6		6				38	3	6,700
CPR 2006-4	0.6	4	1.2	0.55	11°	38	3	6,000
CPR 2006-6		6				38	3	6,000
CPR 2007-4	0.7	4	1.4	0.65	11°	38	3	6,100
CPR 2007-6		6				38	3	6,100
CPR 2008-6	0.8	6	1.6	0.75	11°	45	4	5,100
CPR 2008-8		8				45	4	5,100
CPR 2009-6	0.9	6	1.8	0.85	11°	45	4	5,100
CPR 2009-10		10				45	4	5,100
CPR 2010-6	1	6	2	0.9	11°	45	4	5,040
CPR 2010-8		8				45	4	5,040
CPR 2010-10		10				45	4	5,040
CPR 2010-12		12				45	4	5,040
CPR 2010-16		16				50	4	5,040
CPR 2010-21		21				55	4	6,000
CPR 2012-6	1.2	6	2.4	1.1	11°	45	4	5,100
CPR 2012-8		8				45	4	5,100
CPR 2012-10		10				45	4	5,100
CPR 2012-12		12				50	4	5,100

Unit (mm)

Model Number	Outside Diameter ϕD	Effective Length ℓ_1	Length of Cut ℓ	Neck Diameter ϕd_1	Shank Taper Angle Bta	Overall Length L	Shank Diameter ϕd	Suggested Retail Price ¥
CPR 2014-6	1.4	6	2.8	1.3	11°	45	4	5,100
CPR 2014-10		10				45	4	5,100
CPR 2014-16		16				50	4	5,100
CPR 2015-6	1.5	6	3	1.4	11°	45	4	5,100
CPR 2015-10		10				45	4	5,100
CPR 2015-14		14				50	4	5,100
CPR 2015-16		16				50	4	5,100
CPR 2015-21		21				55	4	5,100
CPR 2016-6	1.6	6	3.2	1.5	11°	50	4	5,100
CPR 2020-8	2	8	4	1.9	11°	50	4	5,040
CPR 2020-10		10				50	4	5,040
CPR 2020-12		12				50	4	5,040
CPR 2020-14		14				50	4	5,040
CPR 2020-16		16				50	4	5,040
CPR 2020-18		18				55	4	5,040
CPR 2020-21		21				55	4	5,040
CPR 2020-26		26				55	4	5,100
CPR 2020-32		32				70	4	6,100
CPR 2025-12		2.5				12	5	2.3
CPR 2025-21	21		55	4	5,600			
CPR 2030-8	3	8	6	2.8	11°	70	6	6,510
CPR 2030-12		12				70	6	6,510
CPR 2030-16		16				70	6	6,510
CPR 2030-21		21				70	6	6,510
CPR 2030-26		26				70	6	6,510
CPR 2030-32		32				80	6	7,200
CPR 2030-42		42				90	6	8,400
CPR 2040-12		4				12	8	3.8
CPR 2040-16	16		70	6	6,930			
CPR 2040-18	18		70	6	6,930			
CPR 2040-21	21		70	6	6,930			
CPR 2040-24	24		70	6	6,930			
CPR 2040-32	32		70	6	6,930			
CPR 2040-36	36		70	6	6,930			
CPR 2040-42	42		80	6	7,250			
CPR 2040-52	52		100	6	9,350			
CPR 2050-16	5		16	10	4.8	11°		
CPR 2050-22		22	80				6	7,980
CPR 2050-32		32	80				6	7,980
CPR 2060-12	6	No Under Cut	12	No Under Cut	—	80	6	7,670
CPR 2060-42		42		5.8		80	6	7,980
CPR 2060-52		52				120	6	11,030
CPR 2060-63		63		120		6	11,030	

3mm Shank
V Series

UDC-PCD
Series

CBN
Series

Square

Long Neck
Square

Radius

Radius

Long Neck
Radius

Taper Neck
Radius

Ball

Ball / Long
Shank Ball

Long Neck
Ball

Taper Neck
Ball

Taper

Taper

Barrel

Spiral
V Cutter

Drill

Technical Data

Milling Conditions for CPR

WORK MATERIAL			ABS / MC NYLON			ACRYLIC / POLYACETAL			POLYCARBONATE			GLASS FIBER REINFORCED POLYCARBONATE			
Model Number	Outside Diameter (mm)	Effective Length (mm)	Spindle Speed (min ⁻¹)	Feed Rate (mm/min)	a _D Axial Depth (mm)	Spindle Speed (min ⁻¹)	Feed Rate (mm/min)	a _D Axial Depth (mm)	Spindle Speed (min ⁻¹)	Feed Rate (mm/min)	a _D Axial Depth (mm)	Spindle Speed (min ⁻¹)	Feed Rate (mm/min)	a _D Axial Depth (mm)	
2005-2	0.5	2	6,000	300	0.2	15,000	300	0.2	9,000	300	0.2	9,000	450	0.2	
		2005-4	4	6,000	300	0.2	15,000	300	0.2	9,000	300	0.2	9,000	450	0.2
		2005-6	6	6,000	300	0.2	15,000	300	0.2	9,000	300	0.2	9,000	450	0.2
2006-4	0.6	4	6,000	340	0.2	14,400	300	0.2	8,800	540	0.2	8,800	810	0.2	
		2006-6	6	6,000	340	0.2	14,400	300	0.2	8,800	540	0.2	8,800	810	0.2
2007-4	0.7	4	6,000	380	0.2	13,800	300	0.2	8,600	780	0.2	8,600	1,170	0.2	
		2007-6	6	6,000	380	0.2	13,800	300	0.2	8,600	780	0.2	8,600	1,170	0.2
2008-6	0.8	6	6,000	420	0.2	13,200	300	0.2	8,400	1,000	0.2	8,400	1,500	0.2	
		2008-8	8	6,000	420	0.2	12,900	280	0.2	8,200	960	0.2	8,200	1,440	0.2
2009-6	0.9	6	6,000	460	0.2	12,600	300	0.2	8,200	1,300	0.2	8,200	1,950	0.2	
		2009-10	10	6,000	460	0.2	11,800	260	0.2	7,800	1,000	0.2	7,800	1,500	0.2
2010-6	1	6	6,000	500	0.3	12,000	300	0.3	8,000	1,500	0.3	8,000	2,250	0.3	
		2010-8	8	6,000	500	0.3	11,500	270	0.3	7,700	1,400	0.3	7,700	2,100	0.3
		2010-10	10	6,000	500	0.3	11,000	240	0.3	7,500	1,200	0.3	7,500	1,800	0.3
		2010-12	12	6,000	500	0.3	10,400	220	0.3	7,200	1,100	0.3	7,200	1,650	0.3
		2010-16	16	6,000	500	0.3	9,300	160	0.3	6,700	830	0.3	6,700	1,245	0.3
		2010-21	21	6,000	500	0.3	8,000	90	0.3	6,000	500	0.3	6,000	750	0.3
2012-6	1.2	6	6,000	610	0.4	11,700	330	0.4	8,000	1,500	0.4	8,000	2,250	0.4	
		2012-8	8	6,000	610	0.4	11,200	300	0.4	7,700	1,400	0.4	7,700	2,100	0.4
		2012-10	10	6,000	600	0.4	10,700	280	0.4	7,500	1,300	0.4	7,500	1,950	0.4
		2012-12	12	6,000	600	0.4	10,200	250	0.4	7,200	1,200	0.4	7,200	1,800	0.4
2014-6	1.4	6	6,000	720	0.4	11,340	360	0.4	8,000	1,600	0.4	8,000	2,400	0.4	
		2014-10	10	6,000	700	0.4	10,700	310	0.4	7,700	1,400	0.4	7,700	2,100	0.4
		2014-16	16	6,000	680	0.4	9,800	230	0.4	7,200	1,000	0.4	7,200	1,500	0.4
2015-6	1.5	6	6,100	780	0.5	11,200	380	0.5	8,000	1,600	0.5	8,000	1,700	0.5	
		2015-10	10	6,000	760	0.5	10,200	330	0.5	7,500	1,400	0.5	7,500	1,600	0.5
		2015-14	14	6,000	730	0.5	9,600	270	0.5	7,000	1,100	0.5	7,000	1,400	0.5
		2015-16	16	6,000	730	0.5	8,800	250	0.5	6,700	1,000	0.5	6,700	1,400	0.5
		2015-21	21	5,900	700	0.5	7,600	180	0.5	6,100	750	0.5	6,100	1,200	0.5
2016-6	1.6	6	6,100	830	0.8	11,000	390	0.8	8,000	1,600	0.8	8,000	1,700	0.8	
		2020-8	8	6,100	1,000	1	10,100	440	1	7,900	1,700	1	7,900	1,800	1
		2020-10	10	6,000	980	1	9,800	420	1	7,700	1,600	1	7,700	1,800	1
		2020-12	12	6,000	970	1	9,500	400	1	7,500	1,600	1	7,500	1,700	1
2020-14	2	14	5,900	950	1	9,100	380	1	7,300	1,500	1	7,300	1,700	1	
		2020-16	16	5,900	930	1	8,800	360	1	7,100	1,400	1	7,100	1,600	1
		2020-18	18	5,800	920	1	8,500	340	1	6,900	1,300	1	6,900	1,600	1
		2020-21	21	5,700	890	1	8,000	300	1	6,500	1,200	1	6,500	1,500	1
		2020-26	26	5,600	850	1	7,200	250	1	6,000	1,100	1	6,000	1,400	1
		2020-32	32	5,400	800	1	6,200	190	1	5,400	850	1	5,400	1,300	1
2025-12	2.5	12	6,000	1,300	1.2	8,600	480	1.2	7,400	1,600	1.2	7,400	1,900	1.2	
		2025-21	21	5,700	1,100	1	6,800	350	1	6,200	1,300	1	6,200	1,600	1

φ3mm Shank V Series

UDC-PCD Series

CBN Series

Square
Long Neck Square

Radius

Radius
Long Neck Radius
Taper Neck Radius

Ball / Long Shank Ball

Ball
Long Neck Ball
Taper Neck Ball

Taper

Barrel

Spiral V Cutter

Drill

Technical Data

Milling Conditions for CPR

WORK MATERIAL			ABS / MC NYLON			ACRYLIC / POLYACETAL			POLYCARBONATE			GLASS FIBER REINFORCED POLYCARBONATE		
Model Number	Outside Diameter (mm)	Effective Length (mm)	Spindle Speed (min ⁻¹)	Feed Rate (mm/min)	a _D Axial Depth (mm)	Spindle Speed (min ⁻¹)	Feed Rate (mm/min)	a _D Axial Depth (mm)	Spindle Speed (min ⁻¹)	Feed Rate (mm/min)	a _D Axial Depth (mm)	Spindle Speed (min ⁻¹)	Feed Rate (mm/min)	a _D Axial Depth (mm)
2030-8	3	8	6,200	1,600	1.5	8,700	610	1.5	8,000	1,900	1.5	8,000	2,200	1.5
2030-12		12	6,000	1,500	1.5	8,000	560	1.5	7,500	1,800	1.5	7,500	2,100	1.5
2030-16		16	5,800	1,400	1.5	7,300	510	1.5	7,000	1,700	1.5	7,000	2,000	1.5
2030-21		21	5,600	1,300	1.5	6,400	440	1.5	6,300	1,500	1.5	6,300	1,800	1.5
2030-26		26	5,400	1,200	1.5	5,500	370	1.5	5,600	1,400	1.5	5,600	1,700	1.5
2030-32		32	5,200	1,100	1.5	4,500	290	1.5	4,800	1,200	1.5	4,800	1,400	1.5
2030-42		42	4,800	960	1.5	2,700	160	1.5	3,500	840	1.5	3,500	1,000	1.5
2040-12	4	12	5,000	1,400	2	7,000	520	2	5,800	1,500	2	5,800	1,800	2
2040-16		16	4,900	1,400	2	6,500	480	2	5,500	1,400	2	5,500	1,700	2
2040-18		18	4,800	1,400	2	6,300	470	2	5,400	1,400	2	5,400	1,700	2
2040-21		21	4,800	1,400	2	6,000	440	2	5,100	1,300	2	5,100	1,600	2
2040-24		24	4,700	1,300	2	5,600	410	2	4,900	1,300	2	4,900	1,600	2
2040-32		32	4,500	1,300	2	4,700	340	2	4,400	1,100	2	4,400	1,500	2
2040-36		36	4,300	1,300	2	4,200	300	2	4,100	1,100	2	4,100	1,400	2
2040-42		42	4,200	1,300	2	3,600	250	2	3,600	960	2	3,600	1,200	2
2040-52	52	3,900	1,200	2	2,400	160	2	2,900	780	2	2,900	1,000	2	
2050-16	5	16	3,400	1,200	2.5	5,800	470	2.5	4,000	1,200	2.5	4,000	1,400	2.5
2050-22		22	3,300	1,100	2.5	5,100	390	2.5	3,600	1,100	2.5	3,600	1,300	2.5
2050-32		32	3,200	1,100	2.5	3,900	260	2.5	2,900	910	2.5	2,900	1,100	2.5
2060-12	6	12	3,000	1,200	3	5,000	450	3	2,500	1,000	3	2,500	1,500	3
2060-42		42	2,400	960	3	2,600	240	3	1,900	760	3	1,900	1,140	3
2060-52		52	2,200	890	3	1,900	170	3	1,700	670	3	1,700	1,005	3
2060-63		63	2,000	800	3	1,000	90	3	1,500	600	3	1,500	900	3

Milling Amount for Slotting (mm)

$$a_e \leq 0.5D$$

D : Outside Diameter (mm)

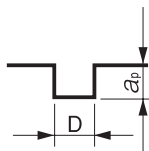

CPR Finishing Conditions for Side Milling

Refer to the slotting parameters for speeds and feeds.

Set the milling amount as below during side milling finishing.

Milling Amount for Side Finishing (mm)

$$a_e : 0.01 \sim 0.015D \text{ (Min 0.01 mm)}$$

D : Outside Diameter (mm)

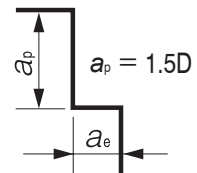

Note:

- Control the radial depth (ae) by approximately 0.01-0.015 times of the outside diameter or set to 0.01 mm the minimum during side milling finishing.
- Increase the feed rate per flute to reduce burring on surface of softer materials.
- Chattering may occur when using a spindle with low rigidity or when milling unstable work piece. Reduce the milling amount in this case.
- Recommend to reduce the milling amount when using a machine with low spindle speed. Not recommend to reduce the feed rate.
- Recommend water soluble coolant for Copper and Aluminum Alloys.
- Recommend air blow for Plastics.
- Remove chips from the work piece to keep the milling surface quality.
- If chips clog on the tool, stop the operation and remove them accordingly.

Ø3mm Shank
V Series

UDC-PCD
Series

CBN
Series

Square
Long Neck
Square

Radius
Long Neck
Radius

Taper Neck
Radius

Ball / Long
Shank Ball

Long Neck
Ball

Taper Neck
Ball

Taper

Barrel

Spiral
V Cutter

Drill

Technical Data



Size $\phi 0.5 \sim \phi 4$

CPRL



($\phi 0.5 \sim \phi 2$) ($\phi 3$ or above)

Material Applications (★ Highly Recommended ● Recommended ○ Suggested)

Work Material																	
Carbon Steels S45C S55C	Alloy Steels SK / SCM SUS	Prehardened Steels NAK HPM	Hardened Steels					Cast Iron	Aluminum Alloys	Graphite	Copper	Plastics	Glass Filled Plastics	Titanium Alloys	Heat Resistant Alloys	Cemented Carbide	Hard Brittle (Non-Metallic) Materials
			~50HRC	~55HRC	~60HRC	~65HRC	~70HRC										
											○	●	★				

Features

Long Neck & Long Shank Square End Mills for milling Plastics.
High performance for deep rib cut milling.
Excellent cutting performance for milling Plastics.

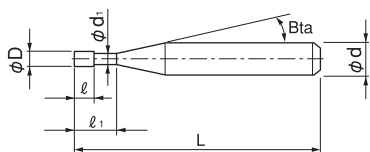

The shank taper angle shown is not an exact value and to avoid contact with the work piece, we recommend the user controls the precise value of this angle. Shank taper angle should not make contact with the work piece.

Total 36 models

Unit (mm)

Model Number	Outside Diameter ϕD	Effective Length ℓ_1	Length of Cut ℓ	Neck Diameter ϕd_1	Shank Taper Angle Bta	Overall Length L	Shank Diameter ϕd	Suggested Retail Price ¥				
CPRL 2005-4	0.5	4	1	0.45	11°	80	4	8,000				
CPRL 2005-6		6				80	4	8,000				
CPRL 2005-8		8				80	4	9,000				
CPRL 2005-10		10				80	4	9,800				
CPRL 2010-6	1	6	2	0.9	11°	80	4	6,000				
CPRL 2010-8		8				80	4	6,000				
CPRL 2010-10		10				80	4	6,000				
CPRL 2010-12		12				80	4	6,000				
CPRL 2010-14		14				80	4	6,000				
CPRL 2010-16		16				80	4	6,000				
CPRL 2010-18		18				80	4	7,200				
CPRL 2010-21		21				80	4	7,800				
CPRL 2015-6		1.5				6	3	1.4	11°	80	4	6,000
CPRL 2015-8						8				80	4	6,000
CPRL 2015-10	10		80	4	6,000							
CPRL 2015-14	14		80	4	6,000							
CPRL 2015-16	16		80	4	6,000							
CPRL 2015-21	21		80	4	6,000							

Unit (mm)

Model Number	Outside Diameter ϕD	Effective Length ℓ_1	Length of Cut ℓ	Neck Diameter ϕd_1	Shank Taper Angle Bta	Overall Length L	Shank Diameter ϕd	Suggested Retail Price ¥
CPRL 2020-8	2	8	4	1.9	11°	80	4	6,000
CPRL 2020-10		10				80	4	6,000
CPRL 2020-12		12				80	4	6,000
CPRL 2020-14		14				80	4	6,000
CPRL 2020-16		16				80	4	6,000
CPRL 2020-18		18				80	4	6,000
CPRL 2020-21		21				80	4	6,000
CPRL 2020-26		26				80	4	6,000
CPRL 2020-32		32				80	4	6,000
CPRL 2020-40		40				100	4	9,400
CPRL 2030-12	3	12	6	2.8	11°	100	6	7,800
CPRL 2030-16		16				100	6	7,800
CPRL 2030-21		21				100	6	7,800
CPRL 2030-26		26				100	6	7,800
CPRL 2030-32		32				100	6	8,600
CPRL 2040-18	4	18	8	3.8	11°	100	6	8,300
CPRL 2040-24		24				100	6	8,300
CPRL 2040-32		32				100	6	8,300

CPRL Series
Acrylic
Milling Video



Other series for Plastics milling

(★ Highly Recommended ● Recommended ○ Suggested)

Number of Flutes, Tool Type	Model Number	Appearance	Coating	Size	Aluminum Alloys	Graphite	Copper	Plastics	Glass Filled Plastics	Hard Brittle (Non-Metallic) Materials	Page
2 flutes Square	CPS		Non-coat	$\phi 0.3 \sim \phi 12$	○		●	★			190
2 flutes Long Neck Square	CPR		Non-coat	$\phi 0.5 \sim \phi 6$	○		●	★			270
2 flutes Long Neck Long Shank Square	CPRL		Non-coat	$\phi 0.5 \sim \phi 4$	○		●	★			274
2 flutes Long Neck Ball	CPRB		Non-coat	R0.2~R3	○		●	★			526

※ Diamond coating series is recommended for Glass Filled Plastics and others abrasive plastics.

3mm Shank
V Series

UDC-PCD
Series

CBN
Series

Square
Long Neck
Square

Radius
Long Neck
Radius

Taper Neck
Radius

Ball / Long
Shank Ball

Long Neck
Ball
Taper Neck
Ball

Taper

Barrel

Spiral
V Cutter

Drill

Technical Data

Milling Conditions for CPRL

Model Number	Outside Diameter (mm)	Effective Length (mm)	ABS / MC NYLON				ACRYLIC / POLYACETAL				POLYCARBONATE				GLASS FIBER REINFORCED POLYCARBONATE			
			Spindle Speed (min ⁻¹)	Feed Rate (mm/min)	a _o Axial Depth (mm)	a _r Radial Depth (mm)	Spindle Speed (min ⁻¹)	Feed Rate (mm/min)	a _o Axial Depth (mm)	a _r Radial Depth (mm)	Spindle Speed (min ⁻¹)	Feed Rate (mm/min)	a _o Axial Depth (mm)	a _r Radial Depth (mm)	Spindle Speed (min ⁻¹)	Feed Rate (mm/min)	a _o Axial Depth (mm)	a _r Radial Depth (mm)
2005-4	0.5	4	6,000	300	0.2	0.5	15,000	300	0.2	0.5	9,000	300	0.2	0.5	9,000	90	0.2	0.5
2005-6		6	6,000	300	0.2	0.5	15,000	300	0.2	0.5	9,000	300	0.2	0.5	9,000	90	0.2	0.5
2005-8		8	6,000	300	0.2	0.5	15,000	300	0.2	0.5	9,000	300	0.2	0.5	9,000	90	0.2	0.5
2005-10		10	6,000	300	0.2	0.5	15,000	300	0.2	0.5	9,000	300	0.2	0.5	9,000	90	0.2	0.5
2010-6		6	6,000	500	0.3	1	12,000	300	0.3	1	8,000	1,500	0.3	1	8,000	1,500	0.3	1
2010-8	8	6,000	500	0.3	1	11,500	270	0.3	1	7,700	1,400	0.3	1	7,700	1,400	0.3	1	
2010-10	10	6,000	500	0.3	1	11,000	240	0.3	1	7,500	1,200	0.3	1	7,500	1,400	0.3	1	
2010-12	12	6,000	500	0.3	1	10,400	220	0.3	1	7,200	1,100	0.3	1	7,200	1,300	0.3	1	
2010-14	14	6,000	500	0.3	1	9,900	190	0.3	1	6,900	970	0.3	1	6,900	1,200	0.3	1	
2010-16	16	6,000	500	0.3	1	9,300	160	0.3	1	6,700	830	0.3	1	6,700	1,200	0.3	1	
2010-18	18	6,000	500	0.3	1	8,800	130	0.3	1	6,400	700	0.3	1	6,400	1,100	0.3	1	
2010-21	21	6,000	500	0.3	1	8,000	90	0.3	1	6,000	500	0.3	1	6,000	1,000	0.3	1	
2015-6	1.5	6	6,100	780	0.5	1.5	11,200	380	0.5	1.5	8,000	1,600	0.5	1.5	8,000	1,700	0.5	1.5
2015-8		8	6,100	770	0.5	1.5	10,700	350	0.5	1.5	7,700	1,500	0.5	1.5	7,700	1,600	0.5	1.5
2015-10		10	6,000	760	0.5	1.5	10,200	330	0.5	1.5	7,500	1,400	0.5	1.5	7,500	1,600	0.5	1.5
2015-14		14	6,000	730	0.5	1.5	9,600	270	0.5	1.5	7,000	1,100	0.5	1.5	7,000	1,400	0.5	1.5
2015-16		16	6,000	730	0.5	1.5	8,800	250	0.5	1.5	6,700	1,000	0.5	1.5	6,700	1,400	0.5	1.5
2015-21		21	5,900	700	0.5	1.5	7,600	180	0.5	1.5	6,100	750	0.5	1.5	6,100	1,200	0.5	1.5
2020-8	2	8	6,100	1,000	1	2	10,100	440	1	2	7,900	1,700	1	2	7,900	1,800	1	2
2020-10		10	6,000	980	1	2	9,800	420	1	2	7,700	1,600	1	2	7,700	1,800	1	2
2020-12		12	6,000	970	1	2	9,500	400	1	2	7,500	1,600	1	2	7,500	1,700	1	2
2020-14		14	5,900	950	1	2	9,100	380	1	2	7,300	1,500	1	2	7,300	1,700	1	2
2020-16		16	5,900	930	1	2	8,800	360	1	2	7,100	1,400	1	2	7,100	1,600	1	2
2020-18		18	5,800	920	1	2	8,500	340	1	2	6,900	1,300	1	2	6,900	1,600	1	2
2020-21		21	5,700	890	1	2	8,000	300	1	2	6,500	1,200	1	2	6,500	1,500	1	2
2020-26		26	5,600	850	1	2	7,200	250	1	2	6,000	1,100	1	2	6,000	1,400	1	2
2020-32		32	5,400	800	1	2	6,200	190	1	2	5,400	850	1	2	5,400	1,300	1	2
2020-40		40	5,200	730	1	2	4,900	110	1	2	4,600	570	1	2	4,600	1,100	1	2
2030-12	3	12	6,000	1,500	1.5	3	8,000	560	1.5	3	7,500	1,800	1.5	3	7,500	2,100	1.5	3
2030-16		16	5,800	1,400	1.5	3	7,300	510	1.5	3	7,000	1,700	1.5	3	7,000	2,000	1.5	3
2030-21		21	5,600	1,300	1.5	3	6,400	440	1.5	3	6,300	1,500	1.5	3	6,300	1,800	1.5	3
2030-26		26	5,400	1,200	1.5	3	5,500	370	1.5	3	5,600	1,400	1.5	3	5,600	1,700	1.5	3
2030-32		32	5,200	1,100	1.5	3	4,500	290	1.5	3	4,800	1,200	1.5	3	4,800	1,400	1.5	3
2040-18	4	18	4,800	1,400	2	4	6,300	470	2	4	5,400	1,400	2	4	5,400	1,700	2	4
2040-24		24	4,700	1,300	2	4	5,600	410	2	4	4,900	1,300	2	4	4,900	1,600	2	4
2040-32		32	4,500	1,300	2	4	4,700	340	2	4	4,400	1,100	2	4	4,400	1,500	2	4

Milling Amount for Slotting (mm)
 $a_p \leq 0.5D$
 D : Outside Diameter (mm)

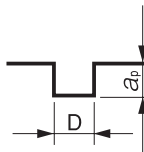

CPRL Finishing Conditions for Side Milling
 Refer to the slotting parameters for speeds and feeds.
 Set the milling amount as below during side milling finishing.

Milling Amount for Side Finishing (mm)
 $a_e : 0.01 \sim 0.015D$ (Min 0.01 mm)
 D : Outside Diameter (mm)

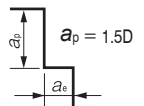

Milling Conditions for CPRL

- Note:
- Control the radial depth (a_p) by approximately 0.01-0.015 times of the outside diameter or set to 0.01 mm the minimum during side milling finishing.
 - Increase the feed per tooth to reduce burr on surface of softer materials.
 - Chattering may occur when using a spindle with low rigidity or when milling unstable work piece. Reduce the milling amount in this case.
 - Recommend to reduce the milling amount when using a machine with low spindle speed. Not recommend to reduce the feed rate.
 - Recommend water soluble coolant for Copper and Aluminum Alloys.
 - Recommend air blow for Plastics.
 - Remove chips from the work piece to keep the milling surface quality.
 - If chips clog on the tool, stop the operation and remove them accordingly.

CPR $\phi 1 \times$ EL6 Slotting Example

MC Nylon

	Spindle speed (min ⁻¹)	Feed rate (mm/min)	a_p (mm)	Feed per tooth (mm/t)
Condition 1	6,000	400	0.3	0.033
Condition 2	6,000	500	0.3	0.042
Condition 3	6,000	600	0.3	0.05



Best result

Condition 1 Vf : 400

Condition 2 Vf : 500

Condition 3 Vf : 600

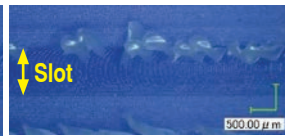
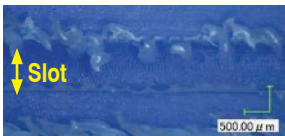

CPR $\phi 1 \times$ EL6 Slotting Example

Polycarbonate

	Spindle speed (min ⁻¹)	Feed rate (mm/min)	a_p (mm)	Feed per tooth (mm/t)
Condition 1	8,000	100	0.3	0.006
Condition 2	8,000	500	0.3	0.031
Condition 3	8,000	1,000	0.3	0.063
Condition 4	8,000	1,500	0.3	0.094
Condition 5	8,000	2,000	0.3	0.125

Best result

Condition 1 Vf : 100

Condition 2 Vf : 500

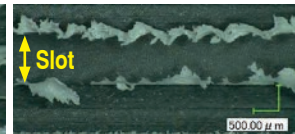
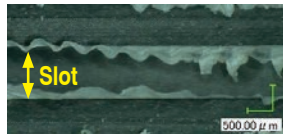

Condition 3 Vf : 1000

Condition 4 Vf : 1500

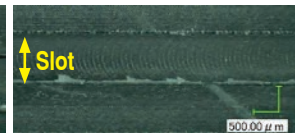
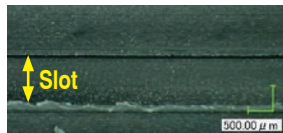

Condition 5 Vf : 2000



Workpiece quality is easily affected by minor differences in milling conditions. Testing several conditions is crucial for milling plastics.

$\phi 3$ mm Shank
V Series

UDC-PCD
Series

CBN
Series

Square
Long Neck
Square

Square

Radius

Radius
Long Neck
Radius

Taper Neck
Radius

Ball / Long
Shank Ball

Ball
Long Neck
Ball

Taper Neck
Ball

Taper

Taper

Barrel

Spiral
V Cutter

Drill

Technical Data



Size $\phi 1 \sim \phi 12$

AZS



Material Applications (★ Highly Recommended ● Recommended ○ Suggested)

Work Material																	
Carbon Steels S45C S55C	Alloy Steels SK / SCM SUS	Prehardened Steels NAK HPM	Hardened Steels					Cast Iron	Aluminum Alloys	Graphite	Copper	Plastics	Glass Filled Plastics	Titanium Alloys	Heat Resistant Alloys	Cemented Carbide	Hard Brittle (Non-Metallic) Materials
			~50HRC	~55HRC	~60HRC	~65HRC	~70HRC										
								★		○	○						

Features

- Capable of verical milling into a flat surface.
- Achieves shorter processing time by removing pre-drilling or ramping cycle.
- 45° helix angle offers excellent chip evacuation.
- The flute shape is specifically designed for reducing burrs on Aluminum Alloys.
- The micro flatland design greatly helps control of chipping.

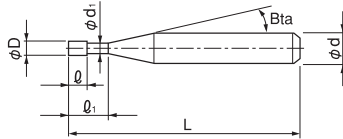

The shank taper angle shown is not an exact value and to avoid contact with the work piece, we recommend the user controls the precise value of this angle. Shank taper angle should not make contact with the work piece.

Diameter Tolerance

Outside Diameter (φD)	Tolerance
$\phi 1 \sim \phi 6, \phi 7, \phi 9, \phi 11$	0 -0.015
$\phi 8, \phi 10, \phi 12$	0 -0.005

■ Micro Flatland Design

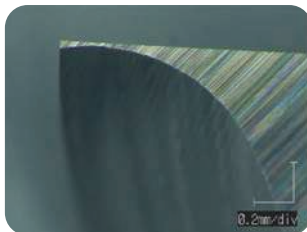

Excellent sharpness + Chipping protection design

■ Smooth Flute Design

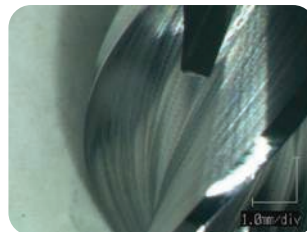

Outstanding chip evacuation by seamless flute.

■ 3 Flute Design

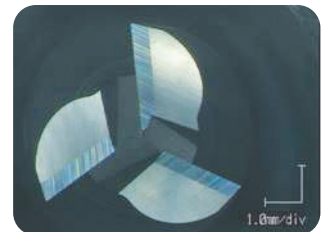

Highly efficient 3 flutes. Significant productivity improvement.

Total 28 models

Unit (mm)

Model Number	Outside Diameter ϕD	Effective Length ℓ_1	Length of Cut ℓ	Neck Diameter ϕd_1	Shank Taper Angle B_{α}	Overall Length L	Shank Diameter ϕd	Suggested Retail Price ¥
AZS 3010-030	1	3	2	0.95	16°	60	4	5,880
AZS 3010-050		5				60		6,400
AZS 3015-045	1.5	4.5	3	1.43	16°	60	4	5,880
AZS 3020-060	2	6	4	1.93	16°	60	4	5,880
AZS 3020-100		10				60		6,400
AZS 3025-075	2.5	7.5	5	2.4	16°	60	4	7,080
AZS 3030-090	3	9	6	2.9	16°	70	6	7,080
AZS 3030-150		15				70		7,700
AZS 3035-105	3.5	10.5	7	3.4	16°	70	6	7,320
AZS 3040-120	4	12	8	3.9	16°	70	6	7,320
AZS 3040-200		20				70		8,000
AZS 3045-135	4.5	13.5	9	4.4	16°	70	6	7,920
AZS 3050-150	5	15	10	4.9	16°	70	6	7,920
AZS 3050-250		25				70		8,700
AZS 3060-180	6	18	12	5.8	—	70	6	8,280
AZS 3060-300		30				70		9,100
AZS 3070-210	7	21	14	6.82	16°	80	8	11,040
AZS 3070-350		35				80		12,100
AZS 3080-240	8	24	16	7.82	—	80	8	11,040
AZS 3080-400		40				80		12,100
AZS 3090-270	9	27	18	8.82	16°	90	10	13,920
AZS 3090-450		45				90		15,300
AZS 3100-300	10	30	20	9.82	—	90	10	13,920
AZS 3100-500		50				90		15,300
AZS 3110-330	11	33	22	10.82	16°	110	12	19,560
AZS 3110-550		55				110		21,500
AZS 3120-360	12	36	24	11.82	—	110	12	19,560
AZS 3120-600		60				110		21,500

3 Flutes

$\phi 3$ mm Shank
V Series

UDC-PCD
Series

CBN
Series

Square

Square
Long Neck
Square

Radius

Radius
Long Neck
Radius

Taper Neck
Radius

Ball / Long
Shank Ball

Ball

Ball
Long Neck
Ball
Taper Neck
Ball

Taper

Taper

Barrel

Spiral
V Cutter

Drill

Technical Data

Roughing Example

A5052

Model Number	Milling Process	Spindle Speed	Z Feed Rate	XY Feed Rate	a_p	a_e	Cycle Time
AZS 3100-300 ($\phi 10 \times EL 30$)	Drilling ①	6,480 min ⁻¹	180 mm/min	—	10 mm	—	6 min 35 sec
	Roughing		—	1,500 mm/min	10 mm	5 mm	
	Drilling ②		180 mm/min	—	20 mm	—	
	Roughing		—	1,500 mm/min	20 mm	5 mm	
AZS 3030-090 ($\phi 3 \times EL 9$)	Drilling + Slotting	14,000 min ⁻¹	145 mm/min	1,450 mm/min	3 mm	—	30 sec

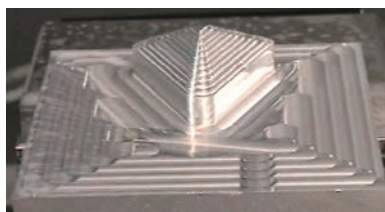

Coolant : Water Soluble

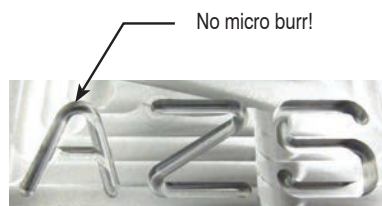

Pocket Milling Example

A7075

Tool	AZS 3060-180 ($\phi 6 \times EL 18$)	
Milling Process	Roughing	Finishing
Spindle Speed	17,600 min ⁻¹	17,600 min ⁻¹
Feed Rate	3,000 mm/min	2,000 mm/min
a_p	6 mm	6 mm
a_e	4.8 mm	0.3 mm

AZS series
A7075
Milling Video



Bottom

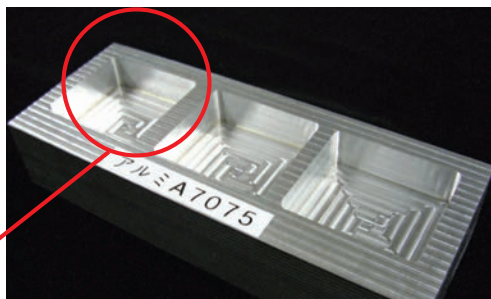

Milling from roughing to finishing
with 1 pc.

Pocket size : 50 x 50 x 18 mm
Coolant : Oil Mist

Slotting Comparison of burrs under different conditions

A5052

3 Flutes







- Coolant Water soluble
- Overhang 20 mm



Tool used
AZS $\phi 5 \times L10 \times EL15$

◆ Feed per tooth fixed at 0.05 mm/t. Comparison of burrs at different spindle speeds and feed rates.



	Spindle speed (min ⁻¹)	Feed rate (mm/min)	Velocity (m/min)	a_p (mm)	Feed per tooth (mm/t)	Milling condition details	Slot wall Down cut side
Condition 1	13,000	2,000	200	3.75 (0.75D)	0.05	Spindle speed and feed rate = Catalogue milling conditions	 Best result
Condition 2	11,700	1,750	180			Spindle speed and feed rate = 10% lower than catalogue milling conditions	
Condition 3	10,000	1,500	160			Spindle speed and feed rate = 25% lower than catalogue milling conditions	 Some burrs
Condition 4	7,700	1,150	120			Spindle speed and feed rate = 40% lower than catalogue milling conditions	
Condition 5	3,200	480	50			Spindle speed and feed rate = 75% lower than catalogue milling conditions	 Most burrs

No burrs under condition 1, catalogue milling conditions.

As the spindle speed was lowered, burrs began to appear, and the most burrs occurred at the velocity of 50 m/min in condition 5.

At the same feed per tooth, burrs were more likely to occur if the velocity was reduced too much.

◆ Spindle speed fixed at 10,000min⁻¹. Comparison of burrs at different feed rates.

	Spindle speed (min ⁻¹)	Feed rate (mm/min)	Velocity (m/min)	a_p (mm)	Feed per tooth (mm/t)	Milling condition details	Slot wall Down cut side
Condition 6	10,000	2,000	160	3.75 (0.75D)	0.07	Spindle speed 10,000min ⁻¹ Feed per tooth +30%	
Condition 7		2,400			0.08	Spindle speed 10,000min ⁻¹ Feed per tooth +60%	

At a fixed spindle speed of 10,000 min⁻¹, burrs slightly increased compared to condition 3 when the feed rate was raised, but there was no significant difference.

$\phi 3$ mm Shank V Series

UDC-PCD Series

CBN Series

Square

Long Neck Square

Radius

Long Neck Radius

Taper Neck Radius

Ball / Long Shank Ball

Long Neck Ball

Taper Neck Ball

Taper

Barrel

Spiral V Cutter

Drill

Technical Data



Size $\phi 1 \sim \phi 12$

DLC-AZS



Material Applications (★ Highly Recommended ● Recommended ○ Suggested)

Work Material																	
Carbon Steels S45C S55C	Alloy Steels SK / SCM SUS	Prehardened Steels NAK HPM	Hardened Steels					Cast Iron	Aluminum Alloys	Graphite	Copper	Plastics	Glass Filled Plastics	Titanium Alloys	Heat Resistant Alloys	Cemented Carbide	Hard Brittle (Non-Metallic) Materials
			~50HRC	~55HRC	~60HRC	~65HRC	~70HRC										
								★			○	○					

Features

- Capable of vertical milling directly into a plane surface.
- Achieves shorter processing time by removing pre-drilling or ramping cycle.
- DLC COAT offers excellent resistance to wear and welding.
- 45° helix angle offers excellent chip evacuation.
- The flute shape is specifically designed for reducing burrs on Aluminum Alloys.
- The micro flatland design greatly helps control of chipping.

The shank taper angle shown is not an exact value and to avoid contact with the work piece, we recommend the user controls the precise value of this angle. Shank taper angle should not make contact with the work piece.

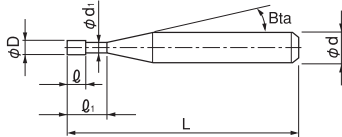

Diameter Tolerance

Outside Diameter (φD)	Tolerance
$\phi 1 \sim \phi 6, \phi 7, \phi 9, \phi 11$	0 -0.015
$\phi 8, \phi 10, \phi 12$	0 -0.005

Total 28 models

Unit (mm)

Model Number	Outside Diameter ϕD	Effective Length ℓ_1	Length of Cut ℓ	Neck Diameter ϕd_1	Shank Taper Angle βta	Overall Length L	Shank Diameter ϕd	Suggested Retail Price ¥
DLC-AZS 3010-030	1	3	2	0.95	16°	60	4	6,200
DLC-AZS 3010-050		5				60		6,750
DLC-AZS 3015-045	1.5	4.5	3	1.43	16°	60	4	6,200
DLC-AZS 3020-060	2	6	4	1.93	16°	60	4	6,200
DLC-AZS 3020-100		10				60		6,750
DLC-AZS 3025-075	2.5	7.5	5	2.4	16°	60	4	7,400
DLC-AZS 3030-090	3	9	6	2.9	16°	70	6	7,400
DLC-AZS 3030-150		15				70		8,050

Unit (mm)

Model Number	Outside Diameter ϕD	Effective Length ℓ_1	Length of Cut ℓ	Neck Diameter ϕd_1	Shank Taper Angle Bta	Overall Length L	Shank Diameter ϕd	Suggested Retail Price ¥
DLC-AZS 3035-105	3.5	10.5	7	3.4	16°	70	6	7,700
DLC-AZS 3040-120	4	12	8	3.9	16°	70	6	7,700
DLC-AZS 3040-200		20				70	6	8,420
DLC-AZS 3045-135	4.5	13.5	9	4.4	16°	70	6	8,300
DLC-AZS 3050-150	5	15	10	4.9	16°	70	6	8,300
DLC-AZS 3050-250		25				70	6	9,120
DLC-AZS 3060-180	6	18	12	5.8	—	70	6	8,700
DLC-AZS 3060-300		30				70	6	9,560
DLC-AZS 3070-210	7	21	14	6.82	16°	80	8	11,600
DLC-AZS 3070-350		35				80	8	12,710
DLC-AZS 3080-240	8	24	16	7.82	—	80	8	11,600
DLC-AZS 3080-400		40				80	8	12,710
DLC-AZS 3090-270	9	27	18	8.82	16°	90	10	14,600
DLC-AZS 3090-450		45				90	10	16,050
DLC-AZS 3100-300	10	30	20	9.82	—	90	10	14,600
DLC-AZS 3100-500		50				90	10	16,050
DLC-AZS 3110-330	11	33	22	10.82	16°	110	12	20,500
DLC-AZS 3110-550		55				110	12	22,530
DLC-AZS 3120-360	12	36	24	11.82	—	110	12	20,500
DLC-AZS 3120-600		60				110	12	22,530

3 Flutes

3mm Shank
V SeriesUDC-PCD
SeriesCBN
Series

Square

Long Neck
Square

Radius

Radius

Long Neck
RadiusTaper Neck
Radius

Ball

Ball / Long
Shank BallLong Neck
BallTaper Neck
Ball

Taper

Taper

Barrel

Barrel

Spiral
V CutterSpiral
V Cutter

Drill

Drill

Technical Data

Technical Data

Milling Conditions for AZS / DLC-AZS

◆ High speed & highly efficient milling conditions

WORK MATERIAL			A5052							
Model Number	Outside Diameter (mm)	Effective Length (mm)	Spindle Speed (min ⁻¹)	Vertical		Slotting		Side Milling		
				Feed Rate (mm/min)	a_p (mm)	Feed Rate (mm/min)	a_p (mm)	Feed Rate (mm/min)	a_p (mm)	a_e (mm)
3010-030	1	3	30,000	150	0.75	900	0.75	1,100	0.75	0.3
3010-050		5	22,500	100	0.75	600	0.75	800	0.75	0.3
3015-045	1.5	4.5	30,000	180	1.125	1,350	1.125	1,630	1.125	0.45
3020-060	2	6	30,000	225	1.5	1,800	1.5	2,150	1.5	0.6
3020-100		10	22,500	150	1.5	1,300	1.5	1,500	1.5	0.6
3025-075	2.5	7.5	25,000	225	1.875	1,900	1.875	2,300	1.875	0.75
3030-090	3	9	21,600	225	2.25	2,000	2.25	2,400	2.25	0.9
3030-150		15	16,200	150	2.25	1,400	2.25	1,700	2.25	0.9
3035-105	3.5	10.5	18,500	270	2.625	2,000	2.625	2,400	2.625	1.05
3040-120	4	12	16,200	300	3	2,000	3	2,400	3	1.2
3040-200		20	12,200	200	3	1,400	3	1,700	3	1.2
3045-135	4.5	13.5	14,400	300	3.375	2,000	3.375	2,400	3.375	1.35
3050-150	5	15	12,960	300	3.75	2,000	3.75	2,400	3.75	1.5
3050-250		25	9,700	200	3.75	1,400	3.75	1,700	3.75	1.5
3060-180	6	18	10,800	300	4.5	2,000	4.5	2,400	4.5	1.8
3060-300		30	8,100	200	4.5	1,400	4.5	1,700	4.5	1.8
3070-210	7	21	9,300	300	5.25	2,000	5.25	2,400	5.25	2.1
3070-350		35	6,900	200	5.25	1,400	5.25	1,700	5.25	2.1
3080-240	8	24	11,400	300	6	2,200	6	2,600	6	2.4
3080-400		40	8,600	200	6	1,500	6	1,800	6	2.4
3090-270	9	27	7,200	275	6.75	2,000	6.75	2,400	6.75	2.7
3090-450		45	5,400	180	6.75	1,400	6.75	1,700	6.75	2.7
3100-300	10	30	9,100	250	7.5	2,200	7.5	2,600	7.5	3
3100-500		50	6,800	160	7.5	1,500	7.5	1,800	7.5	3
3110-330	11	33	5,900	225	8.25	2,000	8.25	2,400	8.25	3.3
3110-550		55	4,400	145	8.25	1,400	8.25	1,700	8.25	3.3
3120-360	12	36	7,600	200	9	2,200	9	2,600	9	3.6
3120-600		60	5,700	130	9	1,500	9	1,800	9	3.6
Milling Amount (mm)				$a_p=0.75D$		$a_p=0.75D$		$a_p=0.75D$ $a_e=0.3D$		

- 3mm Shank V Series
- UDC-PCD Series
- CBN Series
- Square Long Neck Square
- Radius Long Neck Radius
- Taper Neck Radius
- Ball / Long Shank Ball
- Long Neck Ball
- Taper Neck Ball
- Taper
- Barrel
- Spiral V Cutter
- Drill
- Technical Data

Milling Conditions for AZS / DLC-AZS

3 Flutes

WORK MATERIAL			A7075							
Model Number	Outside Diameter (mm)	Effective Length (mm)	Spindle Speed (min ⁻¹)	Vertical		Slotting		Side Milling		
				Feed Rate (mm/min)	a _p (mm)	Feed Rate (mm/min)	a _p (mm)	Feed Rate (mm/min)	a _p (mm)	a _e (mm)
3010-030	1	3	30,000	150	0.75	540	0.75	860	0.75	0.3
3010-050		5	22,500	100	0.75	400	0.75	600	0.75	0.3
3015-045	1.5	4.5	30,000	180	1.125	820	1.125	1,230	1.125	0.45
3020-060	2	6	30,000	225	1.5	1,100	1.5	1,600	1.5	0.6
3020-100		10	22,500	150	1.5	800	1.5	1,100	1.5	0.6
3025-075	2.5	7.5	23,400	220	1.875	1,070	1.875	1,550	1.875	0.75
3030-090	3	9	20,200	225	2.25	1,100	2.25	1,600	2.25	0.9
3030-150		15	15,200	150	2.25	800	2.25	1,100	2.25	0.9
3035-105	3.5	10.5	17,300	270	2.625	1,100	2.625	1,600	2.625	1.05
3040-120	4	12	15,200	300	3	1,100	3	1,600	3	1.2
3040-200		20	11,400	200	3	800	3	1,100	3	1.2
3045-135	4.5	13.5	13,500	300	3.375	1,100	3.375	1,600	3.375	1.35
3050-150	5	15	12,200	300	3.75	1,100	3.75	1,600	3.75	1.5
3050-250		25	9,200	200	3.75	800	3.75	1,100	3.75	1.5
3060-180	6	18	10,100	300	4.5	1,100	4.5	1,600	4.5	1.8
3060-300		30	7,600	200	4.5	800	4.5	1,100	4.5	1.8
3070-210	7	21	8,700	250	5.25	1,100	5.25	1,600	5.25	2.1
3070-350		35	6,500	160	5.25	800	5.25	1,100	5.25	2.1
3080-240	8	24	12,000	250	6	1,800	6	2,400	6	2.4
3080-400		40	9,000	160	6	1,300	6	1,700	6	2.4
3090-270	9	27	6,700	250	6.75	1,100	6.75	1,600	6.75	2.7
3090-450		45	5,100	160	6.75	800	6.75	1,100	6.75	2.7
3100-300	10	30	9,600	250	7.5	1,800	7.5	2,400	7.5	3
3100-500		50	7,200	160	7.5	1,300	7.5	1,700	7.5	3
3110-330	11	33	5,500	250	8.25	1,100	8.25	1,600	8.25	3.3
3110-550		55	4,100	160	8.25	800	8.25	1,100	8.25	3.3
3120-360	12	36	8,000	250	9	1,800	9	2,400	9	3.6
3120-600		60	6,000	160	9	1,300	9	1,700	9	3.6
Milling Amount (mm)				a _p =0.75D		a _p =0.75D		a _p =0.75D a _e =0.3D		

- Ø3mm Shank V Series
- UDC-PCD Series
- CBN Series
- Square
- Long Neck Square
- Radius
- Long Neck Radius
- Taper Neck Radius
- Ball / Long Shank Ball
- Long Neck Ball
- Taper Neck Ball
- Taper
- Barrel
- Spiral V Cutter
- Drill
- Technical Data

Milling Conditions for AZS / DLC-AZS

◆ Low speed & highly efficient milling conditions (Assumed maximum spindle speed: 10,000 min⁻¹ or below)

WORK MATERIAL			A5052							
Model Number	Outside Diameter (mm)	Effective Length (mm)	Spindle Speed (min ⁻¹)	Vertical		Slotting		Side Milling		
				Feed Rate (mm/min)	a _p (mm)	Feed Rate (mm/min)	a _p (mm)	Feed Rate (mm/min)	a _p (mm)	a _e (mm)
3010-030	1	3	10,000	50	0.3	400	0.3	900	1	0.15
3015-045	1.5	4.5	10,000	80	0.45	600	0.45	1,250	1.5	0.225
3020-060	2	6	10,000	100	0.6	800	0.6	1,600	2	0.3
3025-075	2.5	7.5	10,000	130	0.75	1,000	0.75	2,050	2.5	0.375
3030-090	3	9	10,000	150	0.9	1,200	0.9	2,500	3	0.45
3035-105	3.5	10.5	10,000	180	1.05	1,400	1.05	2,600	3.5	0.525
3040-120	4	12	10,000	200	1.2	1,600	1.2	2,700	4	0.6
3045-135	4.5	13.5	10,000	230	1.35	1,800	1.35	3,050	4.5	0.675
3050-150	5	15	10,000	250	1.5	2,000	1.5	3,400	5	0.75
3060-180	6	18	10,000	300	1.8	2,400	1.8	4,000	6	0.9
3070-210	7	21	8,600	300	2.1	2,400	2.1	4,000	7	1.05
3080-240	8	24	8,100	300	2.4	3,000	2.4	4,800	8	1.2
3090-270	9	27	6,700	275	2.7	2,400	2.7	4,000	9	1.35
3100-300	10	30	6,480	250	3	3,000	3	4,800	10	1.5
3110-330	11	33	5,500	225	3.3	2,400	3.3	4,000	11	1.65
3120-360	12	36	5,400	200	3.6	3,000	3.6	4,800	12	1.8
Milling Amount (mm)				a _p =0.3D		a _p =0.3D		a _p =1.0D a _e =0.15D		

φ3mm Shank V Series

UDC-PCD Series

CBN Series

Square
Long Neck Square

Radius

Long Neck Radius
Taper Neck Radius

Ball / Long Shank Ball

Long Neck Ball
Taper Neck Ball

Taper

Barrel

Spiral V Cutter

Drill

Technical Data

Milling Conditions for AZS / DLC-AZS

3 Flutes

WORK MATERIAL			A7075							
Model Number	Outside Diameter (mm)	Effective Length (mm)	Spindle Speed (min ⁻¹)	Vertical		Slotting		Side Milling		
				Feed Rate (mm/min)	a_p (mm)	Feed Rate (mm/min)	a_p (mm)	Feed Rate (mm/min)	a_p (mm)	a_e (mm)
3010-030	1	3	10,000	50	0.3	400	0.3	750	1	0.15
3015-045	1.5	4.5	10,000	80	0.45	600	0.45	1,130	1.5	0.225
3020-060	2	6	10,000	100	0.6	800	0.6	1,500	2	0.3
3025-075	2.5	7.5	10,000	130	0.75	1,000	0.75	1,880	2.5	0.375
3030-090	3	9	10,000	150	0.9	1,200	0.9	2,250	3	0.45
3035-105	3.5	10.5	10,000	180	1.05	1,400	1.05	2,380	3.5	0.525
3040-120	4	12	10,000	200	1.2	1,600	1.2	2,500	4	0.6
3045-135	4.5	13.5	10,000	230	1.35	1,800	1.35	2,750	4.5	0.675
3050-150	5	15	9,600	250	1.5	2,000	1.5	3,000	5	0.75
3060-180	6	18	8,000	250	1.8	2,000	1.8	3,000	6	0.9
3070-210	7	21	6,900	200	2.1	2,000	2.1	3,000	7	1.05
3080-240	8	24	10,000	200	2.4	2,400	2.4	4,100	8	1.2
3090-270	9	27	5,300	200	2.7	2,000	2.7	3,000	9	1.35
3100-300	10	30	8,100	200	3	2,400	3	4,200	10	1.5
3110-330	11	33	4,400	200	3.3	2,000	3.3	3,000	11	1.65
3120-360	12	36	6,800	200	3.6	2,400	3.6	4,200	12	1.8
Milling Amount (mm)				$a_p=0.3D$		$a_p=0.3D$		$a_p=1.0D$ $a_e=0.15D$		

- Note:
- Recommend using a non-contact measuring device to avoid damaging the sharp bottom corner.
 - Decrease both spindle speed and feed rate proportionally in case of chattering.
 - These milling parameters are calculated based on the shortest overhang length. Longer overhangs may require an adjustment to the milling parameters.
 - Reduce the milling amount and feed rate in accordance with required milling precision.
 - Spindle rigidity should be considered when setting milling parameters, especially for Z-Axis drilling.
 - When slotting, using Z-Axis drilling, the milling parameters should promote good chip evacuation.
 - Reduce the milling amount when chips clog on the tool during Z-Axis drilling.
 - Set axial depth (a_p) to 1/3 ($a_p=0.25D$) in the area closest to a vertical wall with more than 2D work depth.
 - These are milling parameters under the work material is firmly fixed. Decrease spindle speed and feed rate according to the condition.
 - Recommend water soluble coolant.

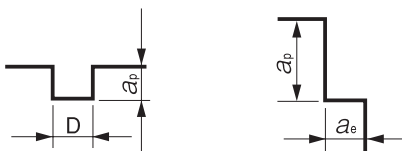

D : Outside Diameter (mm)

- Ø3mm Shank V Series
- UDC-PCD Series
- CBN Series
- Square
 - Long Neck Square
- Radius
 - Long Neck Radius
 - Taper Neck Radius
- Ball / Long Shank Ball
 - Long Neck Ball
 - Taper Neck Ball
- Taper
 - Taper
- Barrel
- Spiral V Cutter
- Drill
- Technical Data



Size $\phi 1 \sim \phi 6$

HLS4000



Material Applications (★ Highly Recommended ● Recommended ○ Suggested)

Work Material																	
Carbon Steels S45C S55C	Alloy Steels SK / SCM SUS	Prehardened Steels NAK HPM	Hardened Steels					Cast Iron	Aluminum Alloys	Graphite	Copper	Plastics	Glass Filled Plastics	Titanium Alloys	Heat Resistant Alloys	Cemented Carbide	Hard Brittle (Non-Metallic) Materials
			~50HRC	~55HRC	~60HRC	~65HRC	~70HRC										
○	○	●	●	●	○		○				○			○	○		

Features

Feature1 : Variable pitch

$\theta_1 > \theta_2$: The unequal division reduces chattering and tip damage.

$\theta_1 + \theta_2 = 180^\circ$: Easy to measure diameter.

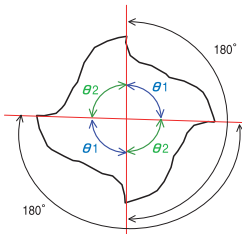

Feature2 : Back taper geometry

Back taper geometry reduces cutting force.

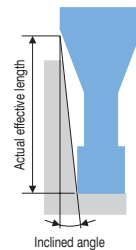
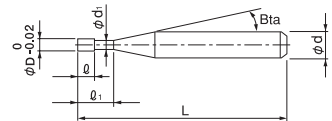
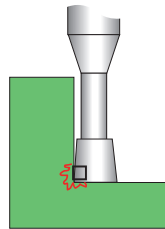

Feature3 : HARDMAX coating with high level of heat resistance, durability and lubrication.
 Feature4 : Improved new 4 flute design offers improved chip evacuation and achieves high feed and milling precision.

The shank taper angle shown is not an exact value and to avoid contact with the work piece, we recommend the user controls the precise value of this angle. Shank taper angle should not make contact with the work piece.

Refer to page 242 for 2 flute HLS.

Total 84 models

Unit (mm)

Model Number	Outside Diameter ϕD	Effective Length ℓ_1	Length of Cut ℓ	Neck Diameter ϕd_1	Shank Taper Angle Bta	Overall Length L	Shank Diameter ϕd	Suggested Retail Price ¥	Effective Length by Inclined Angles				
									30'	1°	1° 30'	2°	3°
									HLS 4010-040	1	4	1	0.95
HLS 4010-060	6	50	4	4,800	6.78	7.10	7.36	7.62	8.19				
HLS 4010-080	8	50	4	4,800	8.88	9.25	9.56	9.90	10.64				
HLS 4010-100	10	50	4	4,800	10.97	11.38	11.76	12.17	13.09				
HLS 4010-120	12	50	4	4,800	13.06	13.51	13.97	14.45	15.53				
HLS 4010-160	16	60	4	7,680	17.20	17.77	18.37	19.01	20.43				
HLS 4012-060	1.2	6	1.2	1.14	16°	50	4	4,800	6.18	6.38	6.60	6.83	7.34
HLS 4012-080		8				50	4	4,800	8.24	8.51	8.80	9.11	9.79
HLS 4012-100		10				50	4	4,800	10.31	10.64	11.00	11.38	12.24
HLS 4012-120		12				50	4	4,800	12.37	12.77	13.20	13.66	14.68
HLS 4012-160		16				50	4	6,720	16.49	17.03	17.60	18.22	19.58
						60	4	6,720	16.49	17.03	17.60	18.22	19.58

Unit (mm)

Model Number	Outside Diameter ϕD	Effective Length ℓ_1	Length of Cut ℓ	Neck Diameter ϕd_1	Shank Taper Angle $B\alpha$	Overall Length L	Shank Diameter ϕd	Suggested Retail Price ¥	Effective Length by Inclined Angles				
									30°	1°	1° 30'	2°	3°
HLS 4014-060	1.4	6	1.4	1.34	16°	50	4	4,800	6.18	6.38	6.60	6.83	7.34
HLS 4014-080		8				50	4	4,800	8.24	8.51	8.80	9.11	9.79
HLS 4014-100		10				50	4	4,800	10.31	10.64	11.00	11.38	12.24
HLS 4014-120		12				50	4	4,800	12.37	12.77	13.20	13.66	14.68
HLS 4014-140		14				60	4	4,800	14.43	14.90	15.40	15.94	17.13
HLS 4014-160		16				60	4	6,720	16.49	17.03	17.60	18.22	19.58
HLS 4014-220		22				60	4	8,640	22.68	23.42	24.21	25.05	No Interference
HLS 4015-060		1.5				6	1.5	1.44	16°	50	4	4,800	6.18
HLS 4015-080	8		50	4	4,800	8.24				8.51	8.80	9.11	9.79
HLS 4015-100	10		50	4	4,800	10.31				10.64	11.00	11.38	12.24
HLS 4015-120	12		50	4	4,800	12.37				12.77	13.20	13.66	14.68
HLS 4015-140	14		60	4	4,800	14.43				14.90	15.40	15.94	17.13
HLS 4015-160	16		60	4	4,800	16.49				17.03	17.60	18.22	19.58
HLS 4015-180	18		60	4	4,800	18.56				19.16	19.80	20.49	22.03
HLS 4015-200	20		60	4	4,800	20.62				21.29	22.00	22.77	No Interference
HLS 4016-060	1.6	6	1.6	1.51	16°	50	4	4,800	6.22	6.42	6.64	6.87	7.39
HLS 4016-080		8				50	4	4,800	8.28	8.55	8.84	9.15	9.83
HLS 4016-100		10				50	4	4,800	10.34	10.68	11.04	11.42	12.28
HLS 4016-120		12				50	4	4,800	12.40	12.81	13.24	13.70	14.73
HLS 4016-140		14				60	4	4,800	14.47	14.94	15.44	15.98	17.17
HLS 4016-160		16				60	4	4,800	16.53	17.07	17.64	18.26	19.62
HLS 4016-180		18				60	4	4,800	18.59	19.20	19.84	20.53	22.07
HLS 4016-200		20				60	4	4,800	20.66	21.33	22.04	22.81	No Interference
HLS 4016-260		26				60	4	11,040	26.84	27.72	28.65	29.64	No Interference
HLS 4018-060		1.8				6	1.8	1.71	16°	50	4	4,800	6.22
HLS 4018-080	8		50	4	4,800	8.28				8.55	8.84	9.15	9.83
HLS 4018-100	10		50	4	4,800	10.34				10.68	11.04	11.42	12.28
HLS 4018-120	12		50	4	4,800	12.40				12.81	13.24	13.70	14.73
HLS 4018-140	14		60	4	4,800	14.47				14.94	15.44	15.98	17.17
HLS 4018-160	16		60	4	4,800	16.53				17.07	17.64	18.26	19.62
HLS 4018-180	18		60	4	4,800	18.59				19.20	19.84	20.53	No Interference
HLS 4018-200	20		60	4	4,800	20.66				21.33	22.04	22.81	No Interference
HLS 4018-250	25		70	4	6,720	25.81				26.65	27.55	28.50	No Interference
HLS 4020-060	2		6	2	1.91	16°				50	4	4,800	6.22
HLS 4020-080		8	50				4	4,800	8.28	8.55	8.84	9.15	9.83
HLS 4020-100		10	50				4	4,800	10.34	10.68	11.04	11.42	12.28
HLS 4020-120		12	50				4	4,800	12.40	12.81	13.24	13.70	14.73
HLS 4020-140		14	60				4	4,800	14.47	14.94	15.44	15.98	17.17
HLS 4020-160		16	60				4	4,800	16.53	17.07	17.64	18.26	No Interference
HLS 4020-180		18	60				4	4,800	18.59	19.20	19.84	20.53	No Interference
HLS 4020-200		20	60				4	4,800	20.66	21.33	22.04	22.81	No Interference
HLS 4020-250		25	70				4	5,280	25.81	26.65	27.55	28.50	No Interference
HLS 4020-300		30	70				4	6,720	30.97	31.97	33.05	No Interference	No Interference

4 Flutes

33mm Shank
V SeriesUDC-PCD
SeriesCBN
Series

Square

Square
Long Neck
Square

Radius

Radius

Long Neck
RadiusTaper Neck
Radius

Ball

Ball / Long
Shank BallLong Neck
BallTaper Neck
Ball

Taper

Taper

Barrel

Barrel

Spiral
V CutterSpiral
V Cutter

Drill

Drill

Technical Data

Technical Data

Unit (mm)

Model Number	Outside Diameter ϕD	Effective Length ℓ_1	Length of Cut ℓ	Neck Diameter ϕd_1	Shank Taper Angle Bta	Overall Length L	Shank Diameter ϕd	Suggested Retail Price ¥	Effective Length by Inclined Angles				
									30'	1°	1° 30'	2°	3°
HLS 4025-080	2.5	8	2.5	2.41	16°	50	4	4,800	8.28	8.55	8.84	9.15	9.83
HLS 4025-120		12				50	4	4,800	12.40	12.81	13.24	13.70	No Interference
HLS 4025-160		16				60	4	4,800	16.53	17.07	17.64	18.26	No Interference
HLS 4025-200		20				60	4	4,800	20.66	21.33	22.04	No Interference	No Interference
HLS 4025-250		25				70	4	4,800	25.81	26.65	27.55	No Interference	No Interference
HLS 4025-300		30				70	4	5,280	30.97	31.97	No Interference	No Interference	No Interference
HLS 4030-080	3	8	3	2.92	16°	50	6	6,720	8.28	8.55	8.84	9.15	9.83
HLS 4030-120		12				50	6	6,720	12.40	12.81	13.24	13.70	14.73
HLS 4030-160		16				60	6	6,720	16.53	17.07	17.64	18.26	19.62
HLS 4030-200		20				60	6	6,720	20.66	21.33	22.04	22.81	24.52
HLS 4030-250		25				70	6	6,720	25.81	26.65	27.55	28.50	No Interference
HLS 4030-300		30				70	6	8,640	30.97	31.97	33.05	34.20	No Interference
HLS 4030-400	40	80	6	8,640	41.28	42.62	44.05	No Interference	No Interference				
HLS 4040-120	4	12	4	3.82	16°	50	6	7,560	12.58	12.99	13.43	13.90	14.94
HLS 4040-160		16				60	6	7,560	16.71	17.25	17.83	18.45	No Interference
HLS 4040-200		20				60	6	7,560	20.84	21.51	22.24	23.01	No Interference
HLS 4040-250		25				70	6	7,560	25.99	26.84	27.74	28.70	No Interference
HLS 4040-300		30				70	6	7,560	31.15	32.16	33.24	No Interference	No Interference
HLS 4040-350		35				80	6	7,560	36.31	37.48	No Interference	No Interference	No Interference
HLS 4040-400	40	90	6	9,600	41.46	42.81	No Interference	No Interference	No Interference				
HLS 4040-450	45	90	6	11,520	46.62	48.13	No Interference	No Interference	No Interference				
HLS 4040-500	50	100	6	14,520	51.78	53.46	No Interference	No Interference	No Interference				
HLS 4050-160	5	16	5	4.82	16°	60	6	9,600	16.78	17.25	18.02	No Interference	No Interference
HLS 4050-250		25				70	6	9,600	25.99	26.84	No Interference	No Interference	No Interference
HLS 4050-350		35				80	6	9,600	36.31	No Interference	No Interference	No Interference	No Interference
HLS 4050-500		50				110	6	14,520	51.78	No Interference	No Interference	No Interference	No Interference
HLS 4060-200	6	20	6	5.82	—	80	6	9,600	No Interference	No Interference	No Interference	No Interference	No Interference
HLS 4060-300		30				90	6	9,600	No Interference	No Interference	No Interference	No Interference	No Interference
HLS 4060-400		40				100	6	11,520	No Interference	No Interference	No Interference	No Interference	No Interference
HLS 4060-500		50				110	6	14,520	No Interference	No Interference	No Interference	No Interference	No Interference

- $\phi 3$ mm Shank V Series
- UDC-PCD Series
- CBN Series
- Square
- Long Neck Square
- Radius
- Long Neck Radius
- Taper Neck Radius
- Ball / Long Shank Ball
- Long Neck Ball
- Taper Neck Ball
- Taper
- Barrel
- Spiral V Cutter
- Drill
- Technical Data

Circle Pocket Milling Example

SKD11 (60HRC)

Tool: HLS $\phi 1.5 \times EL10$ mm

Spindle Speed	7,000 min ⁻¹
Feed Rate	230 mm/min
a_p	0.025 mm
a_e	1.2 mm
Coolant	Air blow (Nozzle)
Overhang Length	18 mm
Pocket Size	$\phi 7 \times 2$ mm
Cycle Time	17 min



SKD11 (60HRC)

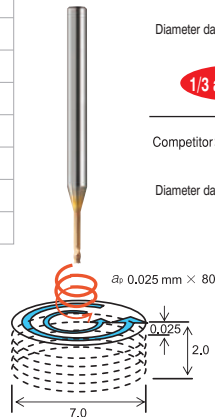

HLS 4 Flutes $\phi 1.5 \times 10$

Diameter damage: 0.091 mm

1/3 and under!

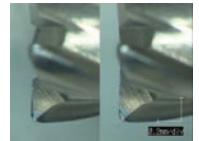

Competitor: 4 Flutes $\phi 1.5 \times 10$

Diameter damage: 0.296 mm

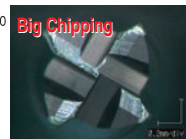

Milling Conditions for HLS (4 Flutes)

4 Flutes

WORK MATERIAL			CARBON STEELS S45C / S50C (~225HB)					ALLOY STEELS SK / SCM / SUS (225~325HB)				PREHARDENED STEELS HARDENED STEELS NAK / SKD (30~45HRC)				HARDENED STEELS SKD / SKT / STAVAX (45~55HRC)				HARDENED STEELS SKD / SKH (55~60HRC)			
Model Number	Outside Diameter (mm)	Effective Length (mm)	Spindle Speed (min ⁻¹)	Feed Rate (mm/min)	a _p Axial Depth (mm)	a _e Radial Depth (mm)	Spindle Speed (min ⁻¹)	Feed Rate (mm/min)	a _p Axial Depth (mm)	a _e Radial Depth (mm)	Spindle Speed (min ⁻¹)	Feed Rate (mm/min)	a _p Axial Depth (mm)	a _e Radial Depth (mm)	Spindle Speed (min ⁻¹)	Feed Rate (mm/min)	a _p Axial Depth (mm)	a _e Radial Depth (mm)	Spindle Speed (min ⁻¹)	Feed Rate (mm/min)	a _p Axial Depth (mm)	a _e Radial Depth (mm)	
4010	1	4	24,700	1,180	0.04	0.351	21,000	950	0.036	0.332	21,500	660	0.028	0.312	17,200	470	0.02	0.293	10,100	240	0.01	0.195	
		6	22,800	1,060	0.024	0.104	19,400	840	0.021	0.099	16,400	590	0.016	0.093	13,100	420	0.012	0.087	9,400	210	0.007	0.058	
		8	20,900	950	0.021	0.043	17,800	740	0.018	0.041	14,600	500	0.014	0.038	11,700	360	0.01	0.036	8,700	190	0.006	0.024	
		10	19,100	840	0.018	0.023	16,200	630	0.015	0.022	13,000	450	0.013	0.021	10,400	320	0.009	0.02	8,100	160	0.005	0.013	
		12	17,300	730	0.015	0.013	14,700	530	0.013	0.012	11,300	380	0.011	0.011	9,000	270	0.008	0.011	7,400	130	0.004	0.007	
		16	13,500	500	0.009	0.005	11,500	320	0.008	0.005	11,000	220	0.007	0.005	8,800	160	0.005	0.005	6,000	80	0.003	0.003	
4012	1.2	6	21,400	1,290	0.04	0.216	18,200	1,020	0.034	0.204	15,400	710	0.027	0.192	12,300	510	0.019	0.18	8,900	260	0.011	0.12	
		8	19,700	1,160	0.035	0.092	16,700	890	0.03	0.087	13,800	620	0.024	0.082	11,000	440	0.017	0.077	8,200	230	0.01	0.051	
		10	17,900	1,020	0.03	0.047	15,200	770	0.026	0.044	12,100	530	0.021	0.042	9,700	380	0.015	0.039	7,600	200	0.009	0.026	
		12	16,200	880	0.025	0.027	13,800	640	0.021	0.026	10,500	450	0.018	0.024	8,400	320	0.013	0.023	6,900	160	0.007	0.015	
		16	12,600	610	0.015	0.011	10,700	330	0.013	0.01	9,900	270	0.007	0.01	7,900	190	0.005	0.009	5,600	100	0.005	0.006	
4014	1.4	6	20,200	1,440	0.068	0.4	17,200	1,140	0.058	0.377	14,500	800	0.046	0.355	11,600	570	0.033	0.333	8,400	290	0.019	0.222	
		8	19,000	1,290	0.06	0.169	16,200	900	0.051	0.16	13,000	690	0.041	0.15	10,400	490	0.029	0.141	7,800	260	0.017	0.094	
		10	17,000	1,140	0.051	0.086	14,500	860	0.043	0.082	11,500	600	0.036	0.077	9,200	430	0.026	0.072	7,100	220	0.014	0.048	
		12	15,300	990	0.043	0.05	13,000	710	0.036	0.048	10,000	500	0.03	0.045	8,000	360	0.022	0.042	6,500	180	0.012	0.028	
		14	13,700	840	0.034	0.032	11,600	570	0.029	0.031	9,800	410	0.025	0.029	7,800	290	0.018	0.027	5,900	140	0.01	0.018	
		16	11,900	680	0.026	0.022	10,100	350	0.022	0.02	9,100	310	0.02	0.019	7,300	220	0.014	0.018	5,300	110	0.008	0.012	
		22	9,000	340	0.013	0.009	6,000	230	0.011	0.009	7,800	170	0.01	0.008	6,200	120	0.007	0.008	3,500	50	0.001	0.005	
4015	1.5	6	19,800	1,520	0.08	0.527	16,800	1,200	0.068	0.498	14,300	840	0.054	0.469	11,400	600	0.039	0.44	8,200	310	0.022	0.293	
		8	18,200	1,360	0.07	0.223	15,500	930	0.06	0.211	12,800	730	0.048	0.198	10,200	520	0.034	0.186	7,600	270	0.02	0.124	
		10	16,600	1,200	0.06	0.113	14,100	900	0.051	0.107	11,300	630	0.042	0.101	9,000	450	0.03	0.095	7,000	230	0.017	0.063	
		12	15,000	1,040	0.05	0.067	12,800	720	0.043	0.063	9,800	530	0.036	0.059	7,800	380	0.026	0.056	6,400	190	0.014	0.037	
		14	13,400	880	0.04	0.041	11,400	600	0.034	0.039	9,500	420	0.03	0.037	7,600	300	0.021	0.035	5,800	150	0.012	0.023	
		16	11,700	720	0.03	0.027	9,900	370	0.026	0.026	8,900	320	0.024	0.024	7,100	230	0.017	0.023	5,200	120	0.009	0.015	
		18	10,100	560	0.02	0.02	9,600	310	0.017	0.019	8,400	240	0.017	0.018	6,700	170	0.012	0.017	4,600	80	0.007	0.011	
		20	8,500	400	0.01	0.014	9,000	280	0.011	0.014	7,900	210	0.011	0.013	6,300	150	0.008	0.012	4,000	40	0.004	0.008	
4016	1.6	6	19,200	1,670	0.08	0.682	15,100	1,320	0.068	0.644	13,900	920	0.054	0.606	11,100	660	0.039	0.569	8,000	340	0.022	0.379	
		8	17,000	1,500	0.07	0.288	15,000	950	0.06	0.272	12,400	800	0.048	0.256	9,900	570	0.034	0.24	7,400	300	0.02	0.16	
		10	16,100	1,320	0.06	0.148	12,700	930	0.051	0.139	10,900	700	0.042	0.131	8,700	500	0.03	0.123	6,800	250	0.017	0.082	
		12	14,500	1,140	0.05	0.085	11,500	750	0.043	0.08	9,500	590	0.036	0.075	7,600	420	0.026	0.071	6,200	210	0.014	0.047	
		14	13,000	970	0.04	0.054	10,300	660	0.034	0.051	9,100	460	0.03	0.048	7,300	330	0.021	0.045	5,600	170	0.012	0.03	
		16	11,400	790	0.03	0.036	9,500	380	0.02	0.034	8,500	350	0.024	0.032	6,800	250	0.017	0.03	5,000	130	0.009	0.02	
		18	9,800	620	0.02	0.025	9,300	340	0.017	0.024	8,000	250	0.017	0.022	6,400	180	0.012	0.021	4,500	80	0.007	0.014	
		20	8,200	440	0.011	0.018	8,700	300	0.011	0.017	7,600	220	0.011	0.016	6,100	160	0.008	0.015	3,900	40	0.004	0.01	
		26	8,000	300	0.007	0.009	7,400	210	0.006	0.009	6,600	170	0.006	0.008	5,300	120	0.004	0.008	2,400	20	0.002	0.005	
4018	1.8	6	18,500	1,820	0.08	1.094	14,900	1,440	0.068	1.034	13,300	1,010	0.054	0.973	10,600	720	0.039	0.912	7,600	370	0.022	0.608	
		8	16,900	1,630	0.07	0.461	14,600	980	0.06	0.435	11,900	870	0.048	0.41	9,500	620	0.034	0.384	7,100	320	0.02	0.256	
		10	15,400	1,440	0.06	0.236	12,500	950	0.051	0.223	10,500	760	0.042	0.21	8,400	540	0.03	0.197	6,500	280	0.017	0.131	
		12	13,900	1,250	0.05	0.137	11,000	770	0.043	0.129	9,100	640	0.036	0.122	7,300	460	0.026	0.114	6,000	230	0.014	0.076	
		14	12,400	1,060	0.04	0.086	9,500	720	0.034	0.082	8,400	500	0.03	0.077	6,700	360	0.021	0.072	5,400	180	0.012	0.048	
		16	10,900	860	0.03	0.058	9,000	450	0.026	0.054	7,900	390	0.024	0.051	6,300	280	0.017	0.048	4,800	140	0.009	0.032	
		18	9,400	670	0.02	0.041	8,700	380	0.017	0.039	7,400	270	0.017	0.037	5,900	190	0.012	0.035	4,300	100	0.007	0.023	
		20	7,900	480	0.015	0.029	8,400	340	0.013	0.027	7,000	240	0.011	0.026	5,600	170	0.008	0.024	3,700	50	0.004	0.016	
		25	7,800	350	0.01	0.014	7,300	260	0.008	0.014	6,300	200	0.007	0.013	5,000	140	0.005	0.012	2,400	20	0.002	0.008	

Ø3mm Shank V Series

UDC-PCD Series

CBN Series

Square
Long Neck Square

Radius
Long Neck Radius
Taper Neck Radius

Ball / Long Shank Ball
Long Neck Ball
Taper Neck Ball

Taper
Taper

Barrel

Spiral V Cutter

Drill

Technical Data

Milling Conditions for HLS (4 Flutes)

WORK MATERIAL			CARBON STEELS S45C / S50C (~225HB)				ALLOY STEELS SK / SCM / SUS (225~325HB)				PREHARDENED STEELS HARDENED STEELS NAK / SKD (30~45HRC)				HARDENED STEELS SKD / SKT / STAVAX (45~55HRC)				HARDENED STEELS SKD / SKH (55~60HRC)			
Model Number	Outside Diameter (mm)	Effective Length (mm)	Spindle Speed (min ⁻¹)	Feed Rate (mm/min)	a _p Axial Depth (mm)	a _e Radial Depth (mm)	Spindle Speed (min ⁻¹)	Feed Rate (mm/min)	a _p Axial Depth (mm)	a _e Radial Depth (mm)	Spindle Speed (min ⁻¹)	Feed Rate (mm/min)	a _p Axial Depth (mm)	a _e Radial Depth (mm)	Spindle Speed (min ⁻¹)	Feed Rate (mm/min)	a _p Axial Depth (mm)	a _e Radial Depth (mm)	Spindle Speed (min ⁻¹)	Feed Rate (mm/min)	a _p Axial Depth (mm)	a _e Radial Depth (mm)
4020	2	6	17,900	1,980	0.08	1.667	14,500	1,560	0.068	1.574	12,900	1,090	0.054	1.482	10,300	780	0.039	1.389	7,400	400	0.022	0.926
		8	16,400	1,770	0.07	0.704	14,200	1,000	0.06	0.665	11,500	950	0.048	0.626	9,200	680	0.034	0.587	6,800	350	0.02	0.391
		10	14,900	1,560	0.06	0.36	12,000	980	0.051	0.34	10,100	830	0.042	0.32	8,100	590	0.03	0.3	6,300	300	0.017	0.2
		12	13,500	1,350	0.05	0.209	10,500	790	0.043	0.197	8,800	690	0.036	0.186	7,000	490	0.026	0.174	5,800	250	0.014	0.116
		14	12,000	1,140	0.04	0.131	9,400	780	0.034	0.124	8,300	550	0.03	0.117	6,600	390	0.021	0.11	5,200	200	0.012	0.073
		16	10,600	940	0.03	0.088	9,000	500	0.026	0.083	7,600	420	0.024	0.078	6,100	300	0.017	0.074	4,700	160	0.009	0.049
		18	9,100	730	0.022	0.061	8,700	420	0.02	0.058	7,300	290	0.017	0.054	5,800	210	0.012	0.051	4,100	100	0.007	0.034
		20	7,700	520	0.018	0.045	8,100	380	0.016	0.043	6,900	270	0.013	0.04	5,500	190	0.009	0.038	3,600	50	0.004	0.025
		25	7,500	390	0.012	0.023	7,100	290	0.011	0.022	6,100	220	0.008	0.021	4,900	160	0.006	0.02	2,400	20	0.002	0.013
		30	7,000	310	0.008	0.013	6,300	230	0.007	0.012	5,600	180	0.006	0.011	4,500	130	0.004	0.011	2,400	10	0.001	0.007
4025	2.5	8				12,800	1,020	0.081	1.622	9,600	980	0.055	1.526	7,700	700	0.039	1.431	6,200	370	0.023	0.954	
		12				10,000	810	0.056	0.481	7,900	700	0.042	0.453	6,300	500	0.03	0.425	5,600	350	0.018	0.283	
		16				8,400	590	0.04	0.202	6,900	450	0.031	0.19	5,500	320	0.022	0.179	4,400	320	0.013	0.119	
		20				7,300	490	0.03	0.104	6,500	420	0.024	0.098	5,200	300	0.017	0.092	3,500	290	0.01	0.061	
		25				6,400	390	0.019	0.053	6,000	380	0.015	0.05	4,800	270	0.011	0.047	2,400	250	0.005	0.031	
		30				5,700	320	0.012	0.031	4,400	350	0.01	0.029	3,500	250	0.007	0.027	2,300	220	0.003	0.018	
4030	3	8				10,900	1,080	0.093	2.361	7,400	1,010	0.073	2.222	5,900	720	0.052	2.084	5,900	440	0.031	1.389	
		12				8,700	830	0.073	0.996	7,000	730	0.057	0.938	5,600	520	0.041	0.879	5,000	400	0.024	0.586	
		16				7,400	670	0.058	0.42	6,000	520	0.045	0.395	5,300	370	0.032	0.371	4,000	370	0.019	0.247	
		20				6,600	560	0.045	0.216	6,100	490	0.035	0.203	4,900	350	0.025	0.191	3,400	340	0.015	0.127	
		25				5,800	460	0.032	0.111	5,600	450	0.025	0.14	4,500	320	0.018	0.098	2,400	290	0.011	0.065	
		30				5,200	390	0.023	0.065	4,300	410	0.02	0.061	3,400	290	0.014	0.057	2,300	250	0.009	0.038	
		40				4,500	280	0.012	0.027	4,100	320	0.014	0.026	3,300	230	0.01	0.024	2,000	170	0.006	0.016	
		12				7,100	950	0.101	3.148	5,100	740	0.101	2.963	4,100	530	0.072	2.778	4,100	460	0.043	1.852	
4040	4	16				6,000	770	0.084	1.328	4,900	600	0.092	1.25	3,900	430	0.066	1.172	3,700	420	0.04	0.781	
		20				5,200	650	0.069	0.68	4,500	560	0.084	0.64	3,600	400	0.06	0.6	3,300	380	0.036	0.4	
		25				4,600	540	0.055	0.349	4,100	520	0.076	0.328	3,300	370	0.054	0.308	2,400	340	0.032	0.205	
		30				4,100	460	0.043	0.202	3,800	460	0.059	0.19	3,000	330	0.042	0.179	2,300	290	0.027	0.119	
		35				3,800	400	0.034	0.128	3,400	420	0.05	0.12	2,700	300	0.036	0.113	2,200	240	0.023	0.075	
		40				3,500	350	0.027	0.085	3,000	380	0.042	0.08	2,400	270	0.03	0.075	1,900	190	0.018	0.05	
		45				3,300	300	0.021	0.06	2,600	320	0.025	0.056	2,100	230	0.018	0.053	1,800	140	0.014	0.035	
		50				3,100	270	0.016	0.044	2,300	280	0.017	0.042	1,800	200	0.012	0.039	1,700	100	0.009	0.026	
4050	5	16				5,100	860	0.128	3.242	4,100	670	0.108	3.051	3,300	480	0.077	2.861	3,300	480	0.048	1.907	
		25				3,800	600	0.102	0.85	3,600	570	0.088	0.8	2,900	410	0.063	0.75	2,400	380	0.037	0.5	
		35				3,100	450	0.077	0.309	2,900	480	0.059	0.291	2,300	340	0.042	0.273	2,000	270	0.026	0.182	
		50				2,400	300	0.034	0.107	2,000	320	0.022	0.101	1,600	230	0.016	0.095	1,500	110	0.01	0.063	
		20				3,800	780	0.17	3.443	3,300	700	0.139	3.24	2,600	500	0.099	3.038	3,300	610	0.06	2.025	
4060	6	30				2,800	540	0.128	1.02	2,800	590	0.101	0.96	2,200	420	0.072	0.9	2,200	360	0.045	0.6	
		40				2,300	410	0.085	0.43	2,100	460	0.063	0.405	1,700	330	0.045	0.38	1,700	240	0.03	0.253	
		50				1,900	310	0.049	0.221	1,600	350	0.038	0.208	1,300	250	0.027	0.195	1,300	120	0.015	0.13	
		20				3,800	780	0.17	3.443	3,300	700	0.139	3.24	2,600	500	0.099	3.038	3,300	610	0.06	2.025	

Recommend
2 flute HLS
or C-CER.

φ3mm Shank
V Series

UDC-PCD
Series

CBN
Series

Square
Long Neck
Square

Radius
Long Neck
Radius
Taper Neck
Radius

Ball / Long
Shank Ball
Long Neck
Ball
Taper Neck
Ball

Taper

Barrel

Spiral
V Cutter

Drill

Technical Data

Milling Conditions for HLS (4 Flutes)

Slotting

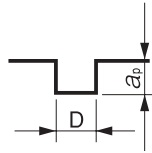

D : Outside Diameter (mm)

Side Milling

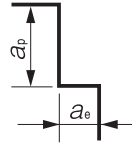

Note:

- Recommend using a non-contact measuring device to avoid damaging the precision tip point.
- Decrease both spindle speed and feed rate proportionally when the milling parameters exceed the machine's maximum spindle speed.
- Every coolant offers stable milling.
- Recommend oil coolant for Stainless Steels and Heat Resistant Alloys.
- Recommend wet coolant for Copper.

4 Flutes

∅3mm Shank
V Series

UDC-PCD
Series

CBN
Series

Square

Square

Long Neck
Square

Radius

Radius

Long Neck
Radius

Taper Neck
Radius

Ball

Ball / Long
Shank Ball

Long Neck
Ball

Taper Neck
Ball

Taper

Taper

Barrel

Spiral
V Cutter

Drill

Technical Data



Size $\phi 1 \sim \phi 12$

CXS



Material Applications (★ Highly Recommended ● Recommended ○ Suggested)

Work Material																	
Carbon Steels S45C S55C	Alloy Steels SK / SCM SUS	Prehardened Steels NAK HPM	Hardened Steels					Cast Iron	Aluminum Alloys	Graphite	Copper	Plastics	Glass Filled Plastics	Titanium Alloys	Heat Resistant Alloys	Cemented Carbide	Hard Brittle (Non-Metallic) Materials
			~50HRC	~55HRC	~60HRC	~65HRC	~70HRC										
●	●	●	●	○				○			●			○	○		

Features

Variable Pitch & Helix design minimizes vibration and chattering.
 Selected high toughness and chip resistant carbide material.
 Optimized flute design offers outstanding high efficiency milling and fine finishing.
 Low friction coating resulting in excellent chip evacuation and resistance to wear.

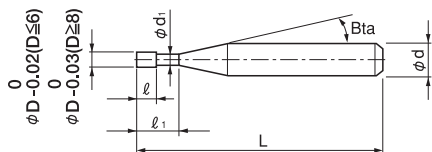

The shank taper angle shown is not an exact value and to avoid contact with the work piece, we recommend the user controls the precise value of this angle. Shank taper angle should not make contact with the work piece.

Total 33 models

Unit (mm)

Model Number	Outside Diameter ϕD	Effective Length ℓ_1	Length of Cut ℓ	Neck Diameter ϕd_1	Shank Taper Angle Bta	Overall Length L	Shank Diameter ϕd	Suggested Retail Price ¥	Effective Length by Inclined Angles				
									30'	1°	1°30'	2°	3°
CXS 4010-030	1	3	1.5	0.96	16°	50	4	6,520	3.25	3.35	3.47	3.59	3.86
CXS 4010-050		5				70	4	6,920	5.31	5.48	5.67	5.87	6.31
CXS 4010-060		6				70	4	7,110	6.34	6.55	6.77	7.00	7.53
CXS 4015-045	1.5	4.5	2.25	1.46	16°	50	4	6,520	4.66	4.81	4.97	5.15	5.53
CXS 4015-070		7				70	4	6,920	7.23	7.47	7.72	7.99	8.59
CXS 4015-085		8.5				70	4	7,110	8.78	9.07	9.37	9.70	10.43
CXS 4020-060	2	6	3	1.94	16°	50	4	6,100	6.24	6.44	6.66	6.89	7.41
CXS 4020-090		9				70	4	6,480	9.33	9.64	9.96	10.31	11.08
CXS 4020-110		11				70	4	6,650	11.40	11.77	12.16	12.59	13.53
CXS 4025-075	2.5	7.5	3.75	2.44	16°	50	4	6,100	7.79	8.04	8.31	8.60	9.25
CXS 4025-110		11				70	4	6,480	11.40	11.77	12.16	12.59	13.53
CXS 4025-135		13.5				70	4	6,650	13.97	14.43	14.91	15.43	No interference

Unit (mm)

Model Number	Outside Diameter ϕD	Effective Length ℓ_1	Length of Cut ℓ	Neck Diameter ϕd_1	Shank Taper Angle β	Overall Length L	Shank Diameter ϕd	Suggested Retail Price ¥	Effective Length by Inclined Angles				
									30°	1°	1°30'	2°	3°
CXS 4030-090	3	9	4.5	2.95	16°	50	6	7,000	9.34	9.64	9.97	10.31	11.09
CXS 4030-130		13				70	6	7,430	13.46	13.90	14.37	14.87	15.98
CXS 4030-160		16				70	6	7,630	16.56	17.10	17.67	18.28	19.65
CXS 4040-120	4	12	6	3.86	16°	50	6	7,350	12.61	13.02	13.46	13.92	14.97
CXS 4040-170		17				70	6	7,800	17.76	18.34	18.96	19.62	No Interference
CXS 4040-210		21				70	6	8,010	21.89	22.60	23.36	24.17	No Interference
CXS 4050-150	5	15	7.5	4.86	16°	50	6	7,900	15.70	16.21	16.76	No Interference	No Interference
CXS 4050-210		21				70	6	8,380	21.89	22.60	No Interference	No Interference	No Interference
CXS 4050-260		26				70	6	8,610	27.05	27.93	No Interference	No Interference	No Interference
CXS 4060-180	6	18	9	5.86	—	50	6	8,500	No Interference	No Interference	No Interference	No Interference	No Interference
CXS 4060-260		26				70	6	9,020	No Interference	No Interference	No Interference	No Interference	No Interference
CXS 4060-320		32				70	6	9,270	No Interference	No Interference	No Interference	No Interference	No Interference
CXS 4080-240	8	24	12	7.82	—	60	8	10,500	No Interference	No Interference	No Interference	No Interference	No Interference
CXS 4080-340		34				90	8	11,140	No Interference	No Interference	No Interference	No Interference	No Interference
CXS 4080-420		42				90	8	11,450	No Interference	No Interference	No Interference	No Interference	No Interference
CXS 4100-300	10	30	15	9.82	—	70	10	12,500	No Interference	No Interference	No Interference	No Interference	No Interference
CXS 4100-420		42				100	10	13,270	No Interference	No Interference	No Interference	No Interference	No Interference
CXS 4100-520		52				100	10	13,630	No Interference	No Interference	No Interference	No Interference	No Interference
CXS 4120-360	12	36	18	11.82	—	90	12	17,800	No Interference	No Interference	No Interference	No Interference	No Interference
CXS 4120-520		52				110	12	18,880	No Interference	No Interference	No Interference	No Interference	No Interference
CXS 4120-620		62				110	12	19,400	No Interference	No Interference	No Interference	No Interference	No Interference

4 Flutes

3mm Shank V Series

UDC-PCD Series

CBN Series

Square

Long Neck Square

Radius

Long Neck Radius

Taper Neck Radius

Ball / Long Shank Ball

Long Neck Ball

Taper Neck Ball

Taper

Barrel

Spiral V Cutter

Drill

Technical Data

4 Flutes Square Variable Pitch and Helix 3 series

Features	Model Number	Appearance	Coating	Size	Carbon Steels	Alloy Steels	Prehardened Steels	Hardened Steels					Aluminum Alloys	Titanium Alloys	Page
								~50 HRC	~55 HRC	~60 HRC	~65 HRC	~70 HRC			
High Efficiency	CXES All flute		UT COAT	$\phi 1 \sim \phi 16$	●	●	●	●	○					○	216
High Efficiency	CXS Long Neck		UT COAT	$\phi 1 \sim \phi 12$	●	●	●	●	○					○	294
High Efficiency for SUS	CESUS All flute		UTS COAT	$\phi 6 \sim \phi 12$	●	★	○							○	228

(★ Highly Recommended ● Recommended ○ Suggested)

Variable pitch

Variable helix

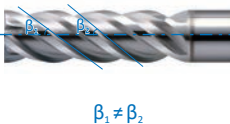
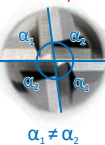

Minimizes chattering

Stable milling under highly efficient conditions

Milling Conditions for CXS

Side Milling

WORK MATERIAL			CARBON STEELS S45C / S50C Annealed Materials (~225HB)				ALLOY STEELS SK / SCM Annealed Materials (225~325HB)				STAINLESS STEELS SUS304 Use water soluble or oil coolant.			
Model Number	Outside Diameter (mm)	Effective Length (mm)	Spindle Speed (min ⁻¹)	Feed Rate (mm/min)	a _p Axial Depth (mm)	a _e Radial Depth (mm)	Spindle Speed (min ⁻¹)	Feed Rate (mm/min)	a _p Axial Depth (mm)	a _e Radial Depth (mm)	Spindle Speed (min ⁻¹)	Feed Rate (mm/min)	a _p Axial Depth (mm)	a _e Radial Depth (mm)
4010-030	1	3	18,000	780	1	0.3	18,000	600	1	0.3	14,500	400	1	0.3
		5	18,000	780	1	0.23	15,330	520	1	0.23	12,570	350	1	0.23
		6	18,000	780	1	0.2	14,000	480	1	0.2	11,600	320	1	0.2
4015-045	1.5	4.5	13,500	970	1.5	0.45	13,500	750	1.5	0.45	13,300	420	1.5	0.45
		7	13,500	970	1.5	0.36	11,810	660	1.5	0.36	11,610	360	1.5	0.36
		8.5	13,500	970	1.5	0.3	10,800	600	1.5	0.3	10,600	330	1.5	0.3
4020-060	2	6	11,000	1,170	2	0.6	11,000	900	2	0.6	12,200	450	2	0.6
		9	11,000	1,170	2	0.48	9,680	790	2	0.48	10,730	400	2	0.48
		11	11,000	1,170	2	0.4	8,800	720	2	0.4	9,750	360	2	0.4
4025-075	2.5	7.5	9,500	1,180	2.5	0.75	9,500	900	2.5	0.75	11,000	550	2.5	0.75
		11	9,500	1,180	2.5	0.6	8,390	800	2.5	0.6	9,720	490	2.5	0.6
		13.5	9,500	1,180	2.5	0.5	7,600	720	2.5	0.5	8,800	440	2.5	0.5
4030-090	3	9	8,500	1,200	3	0.9	8,500	900	3	0.9	10,000	640	3	0.9
		13	8,500	1,200	3	0.73	7,530	800	3	0.73	8,860	570	3	0.73
		16	8,500	1,200	3	0.6	6,800	720	3	0.6	8,000	510	3	0.6
4040-120	4	12	7,200	1,350	4	1.2	6,700	1,000	4	1.2	7,500	730	4	1.2
		17	7,200	1,350	4	0.98	5,920	890	4	0.98	6,670	650	4	0.98
		21	7,200	1,350	4	0.8	5,300	800	4	0.8	6,000	580	4	0.8
4050-150	5	15	6,000	1,500	5	1.5	5,400	1,100	5	1.5	5,400	810	5	1.5
		21	6,000	1,500	5	1.23	4,800	980	5	1.23	4,800	720	5	1.23
		26	6,000	1,500	5	1	4,300	880	5	1	4,300	640	5	1
4060-180	6	18	5,000	1,600	6	1.8	4,500	1,200	6	1.8	4,500	810	6	1.8
		26	5,000	1,600	6	1.46	3,990	1,060	6	1.46	3,990	710	6	1.46
		32	5,000	1,600	6	1.2	3,600	960	6	1.2	3,600	640	6	1.2
4080-240	8	24	3,000	1,300	8	2.4	2,900	1,050	8	2.4	2,900	720	8	2.4
		34	3,000	1,300	8	1.96	2,570	930	8	1.96	2,570	640	8	1.96
		42	3,000	1,300	8	1.6	2,300	840	8	1.6	2,300	570	8	1.6
4100-300	10	30	1,600	1,000	10	3	1,500	900	10	3	1,500	580	10	3
		42	1,600	1,000	10	2.45	1,340	800	10	2.45	1,340	510	10	2.45
		52	1,600	1,000	10	2	1,200	720	10	2	1,200	460	10	2
4120-360	12	36	1,200	800	12	3.6	1,200	750	12	3.6	1,200	540	12	3.6
		52	1,200	800	12	2.86	1,050	660	12	2.86	1,050	470	12	2.86
		62	1,200	800	12	2.4	950	600	12	2.4	950	430	12	2.4

Milling Conditions for CXS

4 Flutes

WORK MATERIAL			PREHARDENED STEELS HPM / NAK (30~45HRC)				HARDENED STEELS SKD / SKT / STAVAX (45~55HRC)			
Model Number	Outside Diameter (mm)	Effective Length (mm)	Spindle Speed (min ⁻¹)	Feed Rate (mm/min)	a_p Axial Depth (mm)	a_e Radial Depth (mm)	Spindle Speed (min ⁻¹)	Feed Rate (mm/min)	a_p Axial Depth (mm)	a_e Radial Depth (mm)
4010-030	1	3	12,900	400	1	0.3	12,900	180	1	0.15
4010-050		5	11,170	350	1	0.23	12,900	180	1	0.12
4010-060		6	10,300	320	1	0.2	12,900	180	1	0.1
4015-045	1.5	4.5	10,500	500	1.5	0.45	9,500	280	1.5	0.225
4015-070		7	9,190	440	1.5	0.36	9,500	280	1.5	0.18
4015-085		8.5	8,400	400	1.5	0.3	9,500	280	1.5	0.15
4020-060	2	6	9,350	560	2	0.6	8,200	390	2	0.3
4020-090		9	8,210	490	2	0.48	8,200	390	2	0.24
4020-110		11	7,450	440	2	0.4	8,200	390	2	0.2
4025-075	2.5	7.5	8,300	610	2.5	0.75	7,800	510	2.5	0.375
4025-110		11	7,340	530	2.5	0.6	7,800	510	2.5	0.3
4025-135		13.5	6,650	480	2.5	0.5	7,800	510	2.5	0.25
4030-090	3	9	7,400	630	3	0.9	7,400	630	3	0.45
4030-130		13	6,540	560	3	0.73	7,400	630	3	0.36
4030-160		16	5,900	500	3	0.6	7,400	630	3	0.3
4040-120	4	12	5,900	650	4	1.2	5,900	650	4	0.6
4040-170		17	5,230	580	4	0.98	5,900	650	4	0.49
4040-210		21	4,700	520	4	0.8	5,900	650	4	0.4
4050-150	5	15	4,800	680	5	1.5	4,800	670	5	0.75
4050-210		21	4,250	600	5	1.23	4,800	670	5	0.61
4050-260		26	3,800	540	5	1	4,800	670	5	0.5
4060-180	6	18	4,000	680	6	1.8	4,000	680	6	0.9
4060-260		26	3,540	600	6	1.46	4,000	680	6	0.73
4060-320		32	3,200	540	6	1.2	4,000	680	6	0.6
4080-240	8	24	2,500	600	8	2.4	2,500	630	8	1.2
4080-340		34	2,220	530	8	1.96	2,500	630	8	0.98
4080-420		42	2,000	480	8	1.6	2,500	630	8	0.8
4100-300	10	30	1,500	430	10	3	1,500	570	10	1.5
4100-420		42	1,340	380	10	2.45	1,500	570	10	1.23
4100-520		52	1,200	340	10	2	1,500	570	10	1
4120-360	12	36	1,000	320	12	3.6	1,200	530	12	1.8
4120-520		52	880	280	12	2.86	1,200	500	12	1.43
4120-620		62	800	250	12	2.4	1,200	480	12	1.2

- $\varnothing 3\text{mm}$ Shank V Series
- UDC-PCD Series
- CBN Series
- Square
- Long Neck Square
- Radius
- Long Neck Radius
- Taper Neck Radius
- Ball / Long Shank Ball
- Long Neck Ball
- Taper Neck Ball
- Taper
- Barrel
- Spiral V Cutter
- Drill
- Technical Data

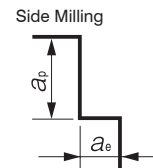

Milling Conditions for CXS

Slotting

WORK MATERIAL			CARBON STEELS S45C / S50C Annealed Materials (~225HB)			ALLOY STEELS SK / SCM Annealed Materials (225~325HB)			STAINLESS STEELS SUS304 Use water soluble or oil coolant.		
Model Number	Outside Diameter (mm)	Effective Length (mm)	Spindle Speed (min ⁻¹)	Feed Rate (mm/min)	a _p Axial Depth (mm)	Spindle Speed (min ⁻¹)	Feed Rate (mm/min)	a _p Axial Depth (mm)	Spindle Speed (min ⁻¹)	Feed Rate (mm/min)	a _p Axial Depth (mm)
4010-030	1	3	18,000	300	1	18,000	300	1	14,500	280	0.5
4010-050		5	18,000	300	0.67	15,330	260	0.67	12,570	240	0.37
4010-060		6	18,000	300	0.5	14,000	240	0.5	11,600	220	0.3
4015-045	1.5	4.5	13,500	450	1.5	13,500	400	1.5	13,300	300	0.75
4015-070		7	13,500	450	1.03	11,810	350	1.03	11,610	260	0.56
4015-085		8.5	13,500	450	0.75	10,800	320	0.75	10,600	240	0.45
4020-060	2	6	11,000	600	2	11,000	400	2	12,200	320	1
4020-090		9	11,000	600	1.4	9,680	350	1.4	10,730	280	0.76
4020-110		11	11,000	600	1	8,800	320	1	9,750	250	0.6
4025-075	2.5	7.5	9,500	600	2.5	9,500	400	2.5	11,000	340	1.25
4025-110		11	9,500	600	1.77	8,390	350	1.77	9,720	300	0.96
4025-135		13.5	9,500	600	1.25	7,600	320	1.25	8,800	270	0.75
4030-090	3	9	8,500	600	3	8,500	400	3	10,000	360	1.5
4030-130		13	8,500	600	2.57	7,530	350	2.14	8,860	310	1.16
4030-160		16	8,500	600	2.25	6,800	320	1.5	8,000	280	0.9
4040-120	4	12	7,200	650	4	6,700	450	4	7,500	400	2
4040-170		17	7,200	650	3.44	5,920	400	2.89	6,670	360	1.56
4040-210		21	7,200	650	3	5,300	360	2	6,000	320	1.2
4050-150	5	15	6,000	700	5	5,400	500	5	5,400	460	2.5
4050-210		21	6,000	700	4.32	4,800	450	3.64	4,800	410	1.95
4050-260		26	6,000	700	3.75	4,300	400	2.5	4,300	360	1.5
4060-180	6	18	5,000	700	6	4,500	500	6	4,500	460	3
4060-260		26	5,000	700	5.14	3,990	440	4.29	3,990	400	2.31
4060-320		32	5,000	700	4.5	3,600	400	3	3,600	360	1.8
4080-240	8	24	3,000	500	8	2,900	360	8	2,900	360	4
4080-340		34	3,000	500	6.89	2,570	320	5.78	2,570	320	3.11
4080-420		42	3,000	500	6	2,300	280	4	2,300	280	2.4
4100-300	10	30	1,600	380	10	1,500	270	10	1,500	220	5
4100-420		42	1,600	380	8.64	1,340	240	7.27	1,340	190	3.91
4100-520		52	1,600	380	7.5	1,200	210	5	1,200	170	3
4120-360	12	36	1,200	300	12	1,200	210	12	1,200	180	6
4120-520		52	1,200	300	10.15	1,050	180	8.31	1,050	160	4.52
4120-620		62	1,200	300	9	950	160	6	950	140	3.6

φ3mm Shank V Series

UDC-PCD Series

CBN Series

Square
Long Neck Square

Radius

Radius
Long Neck Radius
Taper Neck Radius

Ball / Long Shank Ball
Long Neck Ball

Taper Neck Ball

Taper

Barrel

Spiral V Cutter

Drill

Technical Data

Milling Conditions for CXS

WORK MATERIAL			PREHARDENED STEELS HPM / NAK (30~45HRC)			HARDENED STEELS SKD / SKT / STAVAX (45~55HRC)		
Model Number	Outside Diameter (mm)	Effective Length (mm)	Spindle Speed (min ⁻¹)	Feed Rate (mm/min)	a _p Axial Depth (mm)	Spindle Speed (min ⁻¹)	Feed Rate (mm/min)	a _p Axial Depth (mm)
4010-030	1	3	12,900	170	1	12,900	60	0.25
4010-050		5	11,170	140	0.67	setting disable	setting disable	setting disable
4010-060		6	10,300	130	0.5	setting disable	setting disable	setting disable
4015-045	1.5	4.5	10,500	230	1.5	9,500	120	0.375
4015-070		7	9,190	200	1.03	setting disable	setting disable	setting disable
4015-085		8.5	8,400	180	0.75	setting disable	setting disable	setting disable
4020-060	2	6	9,350	280	2	8,200	180	0.5
4020-090		9	8,210	240	1.4	setting disable	setting disable	setting disable
4020-110		11	7,450	220	1	setting disable	setting disable	setting disable
4025-075	2.5	7.5	8,300	300	2.5	7,800	270	0.625
4025-110		11	7,340	270	1.77	setting disable	setting disable	setting disable
4025-135		13.5	6,650	240	1.25	setting disable	setting disable	setting disable
4030-090	3	9	7,400	320	3	7,400	360	1.5
4030-130		13	6,540	280	2.14	setting disable	setting disable	setting disable
4030-160		16	5,900	250	1.5	setting disable	setting disable	setting disable
4040-120	4	12	5,900	390	4	5,900	380	2
4040-170		17	5,230	350	2.89	setting disable	setting disable	setting disable
4040-210		21	4,700	310	2	setting disable	setting disable	setting disable
4050-150	5	15	4,800	440	5	4,800	410	2.5
4050-210		21	4,250	390	3.64	setting disable	setting disable	setting disable
4050-260		26	3,800	350	2.5	setting disable	setting disable	setting disable
4060-180	6	18	4,000	440	6	4,000	440	3
4060-260		26	3,540	390	4.29	setting disable	setting disable	setting disable
4060-320		32	3,200	350	3	setting disable	setting disable	setting disable
4080-240	8	24	2,500	390	8	2,500	340	4
4080-340		34	2,220	350	5.78	setting disable	setting disable	setting disable
4080-420		42	2,000	310	4	setting disable	setting disable	setting disable
4100-300	10	30	1,500	220	10	1,500	240	5
4100-420		42	1,340	190	7.27	setting disable	setting disable	setting disable
4100-520		52	1,200	170	5	setting disable	setting disable	setting disable
4120-360	12	36	1,000	180	12	1,200	220	6
4120-520		52	880	160	8.31	setting disable	setting disable	setting disable
4120-620		62	800	140	6	setting disable	setting disable	setting disable

Contact our sales when milling hardened steels with L/D=5 or longer effective length tools.

Note:

- Decrease both spindle speed and feed rate proportionally in case of chattering.
- These milling parameters are calculated based on the shortest overhang length. Longer overhangs may require an adjustment to the milling parameters.
- Reduce the milling amount and feed rate in accordance with required milling precision.
- Every coolant offers stable milling.
- Recommend water soluble or oil coolant for Stainless Steels and Copper.

Slotting

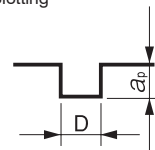

D : Outside Diameter (mm)

φ3mm Shank
V Series

UDC-PCD
Series

CBN
Series

Square
Long Neck
Square

Radius
Long Neck
Radius

Taper Neck
Radius

Ball / Long
Shank Ball
Long Neck
Ball

Taper Neck
Ball

Taper

Barrel

Spiral
V Cutter

Drill

Technical Data

Cutting Load Comparison CXS ϕ 8

SKD61 (50HRC)

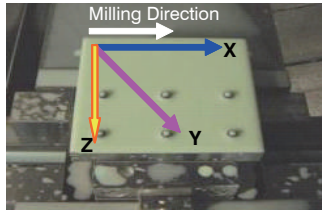

◆Milling Conditions

Spindle Speed	4,200 min ⁻¹
Feed Rate	770 mm/min
a _p	8 mm
a _e	0.3 mm
Coolant	Water Soluble

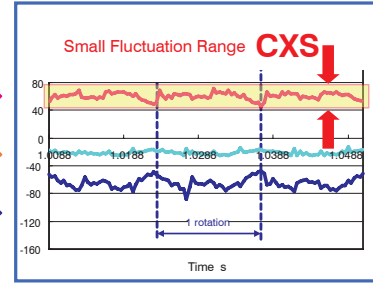
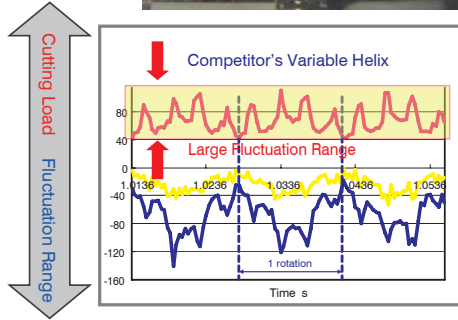

Tool damage and surface quality will be influenced by the cutting load fluctuation range.

CXS has a small fluctuation range and the tool is hard to chatter.

High Efficiency Milling Example CXS ϕ 8

SUS304

CXS	Competitor A: Roughing	Competitor B: Roughing

◆Milling Conditions

Spindle Speed	5,000 min ⁻¹
Feed Rate	600 mm/min
a _p	8 mm
a _e	3 mm
Coolant	Water Soluble
Milling Distance	5.4 m

※Using company B's milling condition











No tool damage on peripheral flute.

- 3mm Shank V Series
- UDC-PCD Series
- CBN Series
- Square
- Long Neck Square
- Radius
- Long Neck Radius
- Taper Neck Radius
- Ball / Long Shank Ball
- Long Neck Ball
- Taper Neck Ball
- Taper
- Barrel
- Spiral V Cutter
- Drill
- Technical Data

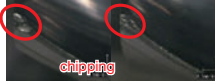
Milling Example by Different Work Materials ① CXS ϕ 8

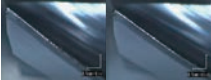
SKD61 (50HRC)

CXS	Competitor A: Variable Helix	Competitor B: Variable Helix
		
		
		
Milling Distance 77 m	Milling Distance 44 m	Milling Distance 22 m

◆Milling Conditions

Spindle Speed	4,200 min ⁻¹
Feed Rate	770 mm/min
a_p	8 mm
a_e	1 mm
Coolant	Water Soluble

※Using company B's milling condition



Designed for a heavy roughing cut, even up to 50HRC

Milling Example by Different Work Materials ② CXS ϕ 8

SUS304

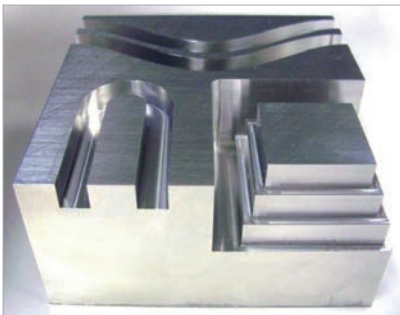

Size : 100 × 100 × 50 mm

◆Milling Conditions

Milling Method	Side Milling, Slotting (One Direction)
Spindle Speed	2,900 min ⁻¹
Feed Rate	360 mm/min (Slotting) 720 mm/min (Side Milling)
a_p	8 mm (1D)
a_e	2.4 mm
Coolant	Water Soluble
Cycle Time	5 min

High efficiency milling of difficult-to-cut material (SUS304).

◆Tool after Milling

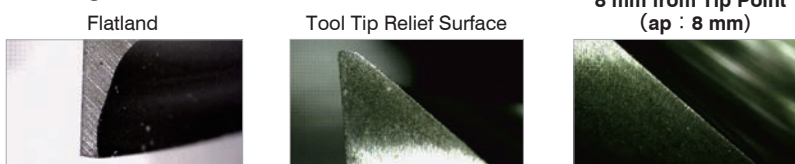

Excellent tool life for high efficiency milling and finishing process.

CXS Series
SUS304
Milling Video



4 Flutes

ϕ 3mm Shank
V Series

UDC-PCD
Series

CBN
Series

Square

Square

Long Neck
Square

Radius

Radius

Radius

Long Neck
Radius

Radius

Taper Neck
Radius

Ball

Ball / Long
Shank Ball

Ball

Long Neck
Ball

Taper

Taper Neck
Ball

Taper

Barrel

Barrel

Spiral

Spiral
V Cutter

Drill

Drill

Technical Data



Size $\phi 1 \sim \phi 12$

C-CRS



Material Applications (★ Highly Recommended ● Recommended ○ Suggested)

Work Material																	
Carbon Steels S45C S55C	Alloy Steels SK / SCM SUS	Prehardened Steels NAK HPM	Hardened Steels					Cast Iron	Aluminum Alloys	Graphite	Copper	Plastics	Glass Filled Plastics	Titanium Alloys	Heat Resistant Alloys	Cemented Carbide	Hard Brittle (Non-Metallic) Materials
			~50HRC	~55HRC	~60HRC	~65HRC	~70HRC										
●	●	●	●	●							●			○	○		

Features

Various range of Corner Radius.

Broad application range from Copper and Carbon Steels up to Hardened Steels (55HRC).

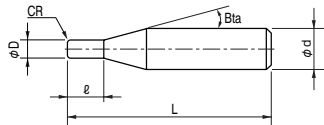

The shank taper angle shown is not an exact value and to avoid contact with the work piece, we recommend the user controls the precise value of this angle. Shank taper angle should not make contact with the work piece.

Total 46 models

Unit (mm)

Model Number	Outside Diameter ϕD	Corner Radius CR	Length of Cut ℓ	Shank Taper Angle Bta	Overall Length L	Shank Diameter ϕd	Suggested Retail Price ¥
C-CRS 2010-02	1	RO.2	2	16°	45	4	7,900
C-CRS 2010-03		RO.3			45	4	7,900
C-CRS 2015-02	1.5	RO.2	3	16°	45	4	7,900
C-CRS 2015-03		RO.3			45	4	7,900
C-CRS 2015-05		RO.5			45	4	7,900
C-CRS 2020-02	2	RO.2	4	16°	45	4	7,900
C-CRS 2020-03		RO.3			45	4	7,900
C-CRS 2020-05		RO.5			45	4	7,900
C-CRS 2025-02	2.5	RO.2	5	16°	45	4	7,900
C-CRS 2025-03		RO.3			45	4	7,900
C-CRS 2025-05		RO.5			45	4	8,600
C-CRS 2030-02	3	RO.2	10	16°	45	6	9,030
C-CRS 2030-03		RO.3			45	6	9,030
C-CRS 2030-05		RO.5			45	6	9,980
C-CRS 2030-10		R1			45	6	10,710

Next Page ➔

Unit (mm)

Model Number	Outside Diameter ϕD	Corner Radius CR	Length of Cut l	Shank Taper Angle Bta	Overall Length L	Shank Diameter ϕd	Suggested Retail Price ¥
C-CRS 2040-02	4	R0.2	12	16°	45	6	9,140
C-CRS 2040-03		R0.3			45	6	9,140
C-CRS 2040-05		R0.5			45	6	10,080
C-CRS 2040-10		R1			45	6	10,820
C-CRS 2050-02	5	R0.2	15	16°	50	6	9,240
C-CRS 2050-03		R0.3			50	6	9,240
C-CRS 2050-05		R0.5			50	6	10,190
C-CRS 2050-10		R1			50	6	10,920
C-CRS 2060-02	6	R0.2	15	—	50	6	10,190
C-CRS 2060-03		R0.3			50	6	10,190
C-CRS 2060-05		R0.5			50	6	10,400
C-CRS 2060-10		R1			50	6	11,130
C-CRS 2060-15		R1.5			50	6	11,550
C-CRS 2060-20		R2			50	6	11,870
C-CRS 2080-05	8	R0.5	20	—	60	8	14,740
C-CRS 2080-10		R1			60	8	15,510
C-CRS 2080-15		R1.5			60	8	15,950
C-CRS 2080-20		R2			60	8	16,280
C-CRS 2080-25		R2.5			60	8	16,720
C-CRS 2100-05	10	R0.5	25	—	70	10	19,140
C-CRS 2100-10		R1			70	10	19,910
C-CRS 2100-15		R1.5			70	10	20,350
C-CRS 2100-20		R2			70	10	20,680
C-CRS 2100-25		R2.5			70	10	21,120
C-CRS 2100-30		R3			70	10	21,120
C-CRS 2120-05	12	R0.5	25	—	75	12	23,980
C-CRS 2120-10		R1			75	12	24,750
C-CRS 2120-15		R1.5			75	12	25,190
C-CRS 2120-20		R2			75	12	25,520
C-CRS 2120-25		R2.5			75	12	25,960
C-CRS 2120-30		R3			75	12	25,960

$\phi 3$ mm Shank
V Series

UDC-PCD
Series

CBN
Series

Square

Square

Long Neck
Square

Radius

Radius

Long Neck
Radius

Taper Neck
Radius

Ball

Ball / Long
Shank Ball

Long Neck
Ball

Taper Neck
Ball

Taper

Taper

Barrel

Barrel

Spiral

Spiral
V Cutter

Drill

Drill

Technical Data

Technical Data

Milling Conditions for C-CRS

WORK MATERIAL		CARBON STEELS S45C / S50C (~225HB)			ALLOY STEELS SK / SCM / SUS (225~325HB)		
Model Number	Outside Diameter (mm)	Spindle Speed (min ⁻¹)	Feed Rate (mm/min)	a_p Axial Depth (mm)	Spindle Speed (min ⁻¹)	Feed Rate (mm/min)	a_p Axial Depth (mm)
2010	1	16,000	340	0.25	12,700	120	0.25
2020	2	8,000	200	0.5	6,400	120	0.5
2025	2.5	6,300	200	0.63	5,100	120	0.63
2030	3	5,000	200	1.5	4,200	120	1.5
2040	4	4,000	240	2	3,200	150	2
2050	5	3,200	240	2.5	2,550	150	2.5
2060	6	2,650	240	3	2,120	150	3
2080	8	2,000	240	4	1,600	150	4
2100	10	1,600	240	5	1,270	150	5
2120	12	1,330	240	6	1,060	150	6

WORK MATERIAL		PREHARDENED STEELS HARDENED STEELS NAK / SKD (30~45HRC)			HARDENED STEELS SKD / SKT (45~50HRC)		
Model Number	Outside Diameter (mm)	Spindle Speed (min ⁻¹)	Feed Rate (mm/min)	a_p Axial Depth (mm)	Spindle Speed (min ⁻¹)	Feed Rate (mm/min)	a_p Axial Depth (mm)
2010	1	9,550	65	0.25	5,580	22	0.05
2020	2	4,800	55	0.5	2,790	31	0.1
2025	2.5	3,800	55	0.63	2,250	31	0.13
2030	3	3,180	55	1.5	2,120	33	0.15
2040	4	2,390	65	2	1,590	39	0.2
2050	5	1,910	65	2.5	1,270	39	0.25
2060	6	1,590	65	3	1,060	39	0.3
2080	8	1,190	70	4	800	39	0.4
2100	10	950	70	5	640	39	0.5
2120	12	800	70	6	530	39	0.6

Milling Amount for Slotting(mm)

45HRC or below

 $D < \phi 3$ $a_p = 0.25D$ $D \geq \phi 3$ $a_p = 0.5D$

45HRC or above

 $a_p = 0.05D$

D : Outside Diameter(mm)

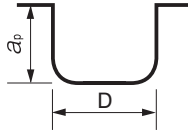

Note:

- Recommend water soluble or oil coolant.
- Recommend oil coolant for Titanium Alloys and Heat Resistant Alloys.

$\phi 3$ mm Shank
V Series

UDC-PCD
Series

CBN
Series

Square

Square

Long Neck
Square

Radius

Radius

Long Neck
Radius

Taper Neck
Radius

Ball

Ball / Long
Shank Ball

Long Neck
Ball

Taper Neck
Ball

Taper

Taper

Barrel

Barrel

Spiral
V Cutter

Spiral
V Cutter

Drill

Drill

Technical Data

Technical Data



Size $\phi 6 \sim \phi 12$

CNRS



$\phi 6$ $\phi 8 \sim \phi 12$

Material Applications (★ Highly Recommended ● Recommended ○ Suggested)

Work Material																	
Carbon Steels S45C S55C	Alloy Steels SK / SCM SUS	Prehardened Steels NAK HPM	Hardened Steels					Cast Iron	Aluminum Alloys	Graphite	Copper	Plastics	Glass Filled Plastics	Titanium Alloys	Heat Resistant Alloys	Cemented Carbide	Hard Brittle (Non-Metallic) Materials
			~50HRC	~55HRC	~60HRC	~65HRC	~70HRC										
●	●	●	●	●				○	○		●			★	★		

Features

4 flute high efficient corner radius designed for Titanium Alloys and Heat Resistant Alloys.
 UTCOAT is recommended for heat-resistant hard materials to achieve longer tool life.
 Variable pitch, high helix and positive rake angle offer stable milling.
 Reduced cutting force when using a helical approach or inclined angles.

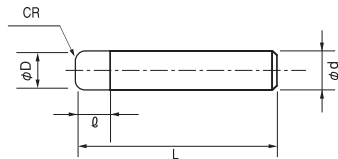

Total 12 models

Unit (mm)

Model Number	Outside Diameter ϕD	Corner Radius CR	Length of Cut l	Overall Length L	Shank Diameter ϕd	Suggested Retail Price ¥
CNRS 4060-05-16	6	R0.5	16	90	6	15,000
CNRS 4060-10-16		R1		90	6	15,000
CNRS 4080-05-16	8	R0.5	16	100	8	17,800
CNRS 4080-10-16		R1		100	8	17,800
CNRS 4100-05-26	10	R0.5	26	110	10	21,800
CNRS 4100-10-26		R1		110	10	21,800
CNRS 4100-15-26		R1.5		110	10	21,800
CNRS 4100-20-26		R2		110	10	21,800
CNRS 4120-05-26	12	R0.5	26	120	12	27,700
CNRS 4120-10-26		R1		120	12	27,700
CNRS 4120-15-26		R1.5		120	12	27,700
CNRS 4120-20-26		R2		120	12	27,700

Milling Conditions for CNRS

◆Side Milling

WORK MATERIAL			CARBON STEELS S45C / S50C				ALLOY STEELS SK / SCM				STAINLESS STEELS SUS			
Model Number	Outside Diameter (mm)	Corner Radius (mm)	Spindle Speed (min ⁻¹)	Feed Rate (mm/min)	a_p Axial Depth (mm)	a_e Radial Depth (mm)	Spindle Speed (min ⁻¹)	Feed Rate (mm/min)	a_p Axial Depth (mm)	a_e Radial Depth (mm)	Spindle Speed (min ⁻¹)	Feed Rate (mm/min)	a_p Axial Depth (mm)	a_e Radial Depth (mm)
4060-05-16	6	R0.5	5,180	1,330	9.6	0.9	4,920	1,330	7.2	0.6	3,520	740	4.8	0.3
4060-10-16		R1	5,180	1,330	9.6	0.9	5,180	1,330	7.2	0.6	3,700	740	4.8	0.3
4080-05-16	8	R0.5	3,920	1,260	12.8	1.2	3,720	1,260	9.6	0.8	2,660	700	6.4	0.4
4080-10-16		R1	3,920	1,260	12.8	1.2	3,920	1,260	9.6	0.8	2,800	700	6.4	0.4
4100-05-26	10	R0.5	2,770	1,225	16	1.5	2,630	1,220	12	1	1,880	680	8	0.5
4100-10-26		R1	2,770	1,225	16	1.5	2,770	1,220	12	1	1,980	680	8	0.5
4100-15-26		R1.5	2,770	1,225	16	1.5	2,930	1,220	12	1	2,090	680	8	0.5
4100-20-26		R2	2,770	1,225	16	1.5	3,080	1,220	12	1	2,200	680	8	0.5
4120-05-26	12	R0.5	2,330	1,170	19.2	1.8	2,210	1,170	14.4	1.2	1,580	650	9.6	0.6
4120-10-26		R1	2,330	1,170	19.2	1.8	2,330	1,170	14.4	1.2	1,670	650	9.6	0.6
4120-15-26		R1.5	2,330	1,170	19.2	1.8	2,470	1,170	14.4	1.2	1,760	650	9.6	0.6
4120-20-26		R2	2,330	1,170	19.2	1.8	2,590	1,170	14.4	1.2	1,850	650	9.6	0.6

WORK MATERIAL			TITANIUM / TITANIUM ALLOYS Ti-6Al-4V				HEAT RESISTANT ALLOYS Inconel718			
Model Number	Outside Diameter (mm)	Corner Radius (mm)	Spindle Speed (min ⁻¹)	Feed Rate (mm/min)	a_p Axial Depth (mm)	a_e Radial Depth (mm)	Spindle Speed (min ⁻¹)	Feed Rate (mm/min)	a_p Axial Depth (mm)	a_e Radial Depth (mm)
4060-05-16	6	R0.5	3,520	740	4.8	0.3	1,710	300	4.8	0.3
4060-10-16		R1	3,700	740	4.8	0.3	1,800	300	4.8	0.3
4080-05-16	8	R0.5	2,660	700	6.4	0.4	1,570	280	6.4	0.4
4080-10-16		R1	2,800	700	6.4	0.4	1,650	280	6.4	0.4
4100-05-26	10	R0.5	1,880	680	8	0.5	1,110	250	8	0.5
4100-10-26		R1	1,980	680	8	0.5	1,170	250	8	0.5
4100-15-26		R1.5	2,090	680	8	0.5	1,240	250	8	0.5
4100-20-26		R2	2,200	680	8	0.5	1,300	250	8	0.5
4120-05-26	12	R0.5	1,580	650	9.6	0.6	940	220	9.6	0.6
4120-10-26		R1	1,670	650	9.6	0.6	990	220	9.6	0.6
4120-15-26		R1.5	1,760	650	9.6	0.6	1,050	220	9.6	0.6
4120-20-26		R2	1,850	650	9.6	0.6	1,100	220	9.6	0.6

Please adjust milling parameters referring following table.

D : $\phi 6 \sim \phi 12$

Overhang Length	Spindle Speed (min ⁻¹)	Feed Rate (mm/min)	a_p Axial Depth (mm)	a_e Radial Depth (mm)
$\sim D \times 4$	$\times 1$	$\times 1$	$\times 1$	$\times 1$
$\sim D \times 5$	$\times 0.7$	$\times 0.7$	$\times 0.7$	$\times 0.8$
$\sim D \times 6$	$\times 0.5$	$\times 0.5$	$\times 0.6$	$\times 0.7$

Side Milling

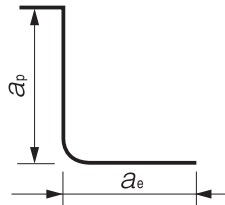

4 Flutes

$\phi 3$ mm Shank
V Series

UDC-PCD
Series

CBN
Series

Square

Long Neck
Square

Radius

Long Neck
Radius

Taper Neck
Radius

Ball / Long
Shank Ball

Long Neck
Ball

Taper Neck
Ball

Taper

Barrel

Spiral
V Cutter

Drill

Technical Data

Milling Conditions for CNRS

◆Slotting

WORK MATERIAL			CARBON STEELS S45C / S50C			ALLOY STEELS SK / SCM			STAINLESS STEELS SUS		
Model Number	Outside Diameter (mm)	Corner Radius (mm)	Spindle Speed (min ⁻¹)	Feed Rate (mm/min)	a _p Axial Depth (mm)	Spindle Speed (min ⁻¹)	Feed Rate (mm/min)	a _p Axial Depth (mm)	Spindle Speed (min ⁻¹)	Feed Rate (mm/min)	a _p Axial Depth (mm)
4060-05-16	6	R0.5	2,035	250	6	1,930	360	3	1,760	330	1.5
4060-10-16		R1	2,035	250	6	2,040	360	3	1,850	330	1.5
4080-05-16	8	R0.5	1,550	210	8	1,470	300	4	1,340	270	2
4080-10-16		R1	1,550	210	8	1,550	300	4	1,410	270	2
4100-05-26	10	R0.5	1,260	210	10	1,200	300	5	1,090	270	2.5
4100-10-26		R1	1,260	210	10	1,260	300	5	1,150	270	2.5
4100-15-26		R1.5	1,260	210	10	1,330	300	5	1,210	270	2.5
4100-20-26		R2	1,260	210	10	1,400	300	5	1,270	270	2.5
4120-05-26	12	R0.5	1,020	200	12	970	290	6	880	260	3
4120-10-26		R1	1,020	200	12	1,020	290	6	930	260	3
4120-15-26		R1.5	1,020	200	12	1,080	290	6	980	260	3
4120-20-26		R2	1,020	200	12	1,140	290	6	1,030	260	3

WORK MATERIAL			TITANIUM / TITANIUM ALLOYS Ti-6Al-4V			HEAT RESISTANT ALLOYS Inconel718		
Model Number	Outside Diameter (mm)	Corner Radius (mm)	Spindle Speed (min ⁻¹)	Feed Rate (mm/min)	a _p Axial Depth (mm)	Spindle Speed (min ⁻¹)	Feed Rate (mm/min)	a _p Axial Depth (mm)
4060-05-16	6	R0.5	1,600	300	0.6	810	100	0.6
4060-10-16		R1	1,680	300	0.6	850	100	0.6
4080-05-16	8	R0.5	1,220	250	0.8	620	90	0.8
4080-10-16		R1	1,280	250	0.8	650	90	0.8
4100-05-26	10	R0.5	990	250	1	460	80	1
4100-10-26		R1	1,040	250	1	490	80	1
4100-15-26		R1.5	1,100	250	1	520	80	1
4100-20-26		R2	1,160	250	1	540	80	1
4120-05-26	12	R0.5	800	240	1.2	380	70	1.2
4120-10-26		R1	840	240	1.2	410	70	1.2
4120-15-26		R1.5	890	240	1.2	430	70	1.2
4120-20-26		R2	940	240	1.2	450	70	1.2

Please adjust milling parameters referring following table.

D : $\phi 6 \sim \phi 12$

Overhang Length	Spindle Speed (min ⁻¹)	Feed Rate (mm/min)	a _p Axial Depth (mm)	a _r Radial Depth (mm)
~D×4	×1	×1	×1	×1
~D×5	×0.7	×0.7	×0.7	×0.8
~D×6	×0.5	×0.5	×0.6	×0.7

Note:

- Decrease both spindle speed and feed rate proportionally when the milling parameters exceed the machine's maximum spindle speed.
- Recommend water soluble or oil coolant.

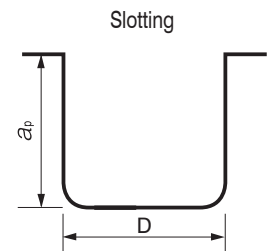

D : Outside Diameter (mm)

Pocket Milling Example: Milling with CNRS $\phi 10 \times CR2$

Ti6Al-4V (30HRC)



Stable milling on hard-to-cut materials

Spindle Speed	Feed Rate	a_p	a_e	Overhang Length	Cycle Time	Coolant	Pocket Size
1,820 min ⁻¹ $V_c=57$ m/min	700 mm/min $f_z=0.096$ mm/t	0.5 mm	5 mm	45 mm (4.5D)	30 min	Water Soluble (Through Spindle)	70 × 44 × 13 mm

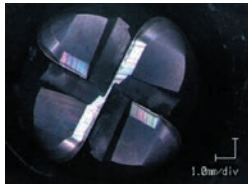

CNRS

Continuous cutting is possible after 60 min milling.

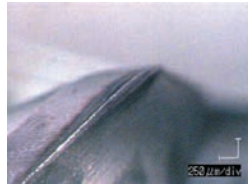
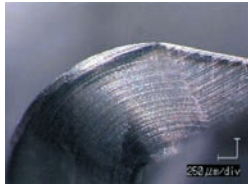

Competitor's Tool

Corner radius is broken after 30min (one pocket) milling.

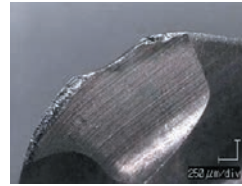

Slotting Example: Milling with CNRS $\phi 8 \times CR1$

Inconel718 (40HRC)

Milling Process	Roughing		Finishing
	Slotting	Side Milling	
Spindle Speed	576 min ⁻¹ ($V_c=14.5$ m/min)	1,650 min ⁻¹ ($V_c=41.5$ m/min)	
Feed Rate	72 mm/min ($f_z=0.03$ mm/t)	280 mm/min ($f_z=0.04$ mm/t)	200 mm/min ($f_z=0.03$ mm/t)
a_p	0.8 mm	6.4 mm	0.1 mm
a_e	—	0.4 mm	0.1 mm
Overhang Length	30 mm (3.75D)		
Coolant	Water Soluble (Nozzle)		
Cycle Time	105 min		10 min

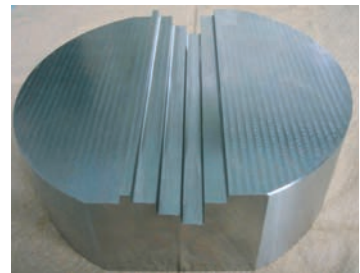

**Reduces burrs in step milling process.
Offers better surface finish with unique cutting edge.**

4 Flutes

$\phi 3$ mm Shank V Series

UDC-PCD Series

CBN Series

Square

Long Neck Square

Radius

Long Neck Radius

Taper Neck Radius

Ball / Long Shank Ball

Long Neck Ball

Taper Neck Ball

Taper

Barrel

Spiral V Cutter

Drill

Technical Data



Size $\phi 1 \sim \phi 12$

CXERS



$\phi 1 \sim \phi 3$ $\phi 4 \sim \phi 6$ $\phi 8 \sim \phi 12$

Material Applications (★ Highly Recommended ● Recommended ○ Suggested)

Work Material																	
Carbon Steels S45C S55C	Alloy Steels SK / SCM SUS	Prehardened Steels NAK HPM	Hardened Steels					Cast Iron	Aluminum Alloys	Graphite	Copper	Plastics	Glass Filled Plastics	Titanium Alloys	Heat Resistant Alloys	Cemented Carbide	Hard Brittle (Non-Metallic) Materials
			~50HRC	~55HRC	~60HRC	~65HRC	~70HRC										
●	●	●	●	●							●			○	○		

Features

Variable Division & Variable Helix design minimizes vibration and chattering.

Selected carbide material with high toughness & high chip resistance.

Excellent wear-resistance for the wide range of milling applications, from highly efficient milling to finishing.

Low friction coating resulting in excellent chip evacuation and resistance to wear.

Decreasing cutting resistance and offering stable milling by the original corner R design.

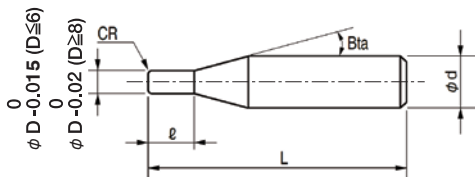

The shank taper angle shown is not an exact value and to avoid contact with the work piece, we recommend the user controls the precise value of this angle. Shank taper angle should not make contact with the work piece.

Total 56 models

Unit (mm)

Model Number	Outside Diameter ϕD	Corner Radius CR	Length of Cut ℓ	Shank Taper Angle Bta	Overall Length L	Shank Diameter ϕd	Suggested Retail Price ¥
CXERS 4010-01-025	1	RO.1	2.5	16°	50	4	6,850
CXERS 4010-02-025		RO.2			50	4	6,850
CXERS 4010-03-025		RO.3			50	4	7,300
CXERS 4015-01-0375	1.5	RO.1	3.75	16°	50	4	6,850
CXERS 4015-02-0375		RO.2			50	4	6,850
CXERS 4015-03-0375		RO.3			50	4	7,300
CXERS 4020-01-050	2	RO.1	5	16°	50	4	6,410
CXERS 4020-02-050		RO.2			50	4	6,410
CXERS 4020-03-050		RO.3			50	4	6,850
CXERS 4020-05-050		RO.5			50	4	6,850
CXERS 4025-03-0625	2.5	RO.3	6.25	16°	50	4	6,850
CXERS 4025-05-0625		RO.5			50	4	6,850
CXERS 4030-02-075	3	RO.2	7.5	16°	60	6	7,350
CXERS 4030-03-075		RO.3			60	6	7,850
CXERS 4030-05-075		RO.5			60	6	7,850

Unit (mm)

Model Number	Outside Diameter ϕD	Corner Radius CR	Length of Cut ℓ	Shank Taper Angle β	Overall Length L	Shank Diameter ϕd	Suggested Retail Price ¥
CXERS 4040-02-100	4	RO.2	10	16°	60	6	7,720
CXERS 4040-03-100		RO.3			60	6	8,250
CXERS 4040-04-100		RO.4			60	6	8,250
CXERS 4040-05-100		RO.5			60	6	8,250
CXERS 4040-10-100		R1			60	6	8,250
CXERS 4050-02-125	5	RO.2	12.5	16°	60	6	8,300
CXERS 4050-03-125		RO.3			60	6	8,850
CXERS 4050-04-125		RO.4			60	6	8,850
CXERS 4050-05-125		RO.5			60	6	8,850
CXERS 4050-10-125		R1			60	6	8,850
CXERS 4060-02-150	6	RO.2	15	—	60	6	8,640
CXERS 4060-03-150		RO.3			60	6	8,640
CXERS 4060-04-150		RO.4			60	6	9,500
CXERS 4060-05-150		RO.5			60	6	9,500
CXERS 4060-10-150		R1			60	6	9,500
CXERS 4060-12-150	R1.2	60	6	9,500			
CXERS 4080-02-200	8	RO.2	20	—	70	8	11,000
CXERS 4080-03-200		RO.3			70	8	11,000
CXERS 4080-04-200		RO.4			70	8	11,800
CXERS 4080-05-200		RO.5			70	8	11,800
CXERS 4080-10-200		R1			70	8	11,800
CXERS 4080-12-200		R1.2			70	8	11,800
CXERS 4080-15-200		R1.5			70	8	11,800
CXERS 4080-20-200		R2			70	8	11,800
CXERS 4100-02-250	10	RO.2	25	—	80	10	13,100
CXERS 4100-03-250		RO.3			80	10	13,100
CXERS 4100-04-250		RO.4			80	10	14,000
CXERS 4100-05-250		RO.5			80	10	14,000
CXERS 4100-10-250		R1			80	10	14,000
CXERS 4100-12-250		R1.2			80	10	14,000
CXERS 4100-15-250		R1.5			80	10	14,000
CXERS 4100-20-250		R2			80	10	14,000
CXERS 4120-02-300	12	RO.2	30	—	100	12	18,750
CXERS 4120-03-300		RO.3			100	12	20,000
CXERS 4120-04-300		RO.4			100	12	20,000
CXERS 4120-05-300		RO.5			100	12	20,000
CXERS 4120-10-300		R1			100	12	20,000
CXERS 4120-12-300		R1.2			100	12	20,000
CXERS 4120-15-300		R1.5			100	12	20,000
CXERS 4120-20-300		R2			100	12	20,000
CXERS 4120-30-300		R3			100	12	20,000

4 Flutes

ø3mm Shank
V SeriesUDC-PCD
SeriesCBN
Series

Square

Square

Long Neck
Square

Radius

Radius

Long Neck
RadiusTaper Neck
Radius

Ball

Ball / Long
Shank BallLong Neck
BallTaper Neck
Ball

Taper

Taper

Barrel

Spiral
V Cutter

Drill

Technical Data

Milling Conditions for CXERS

◆Side Milling

WORK MATERIAL		CARBON STEELS S45C / S50C Annealed Materials (~225HB)				ALLOY STEELS SK / SCM Annealed Materials (225~325HB)				STAINLESS STEELS SUS304 ※Use water soluble or oil coolant.			
Model Number	Outside Diameter (mm)	Spindle Speed (min ⁻¹)	Feed Rate (mm/min)	a_p Axial Depth (mm)	a_e Radial Depth (mm)	Spindle Speed (min ⁻¹)	Feed Rate (mm/min)	a_p Axial Depth (mm)	a_e Radial Depth (mm)	Spindle Speed (min ⁻¹)	Feed Rate (mm/min)	a_p Axial Depth (mm)	a_e Radial Depth (mm)
4010	1	21,600	490	2.5	0.1	21,600	360	2.5	0.1	17,400	250	2.5	0.1
4015	1.5	16,200	610	3.75	0.15	16,200	450	3.75	0.15	15,960	270	3.75	0.15
4020	2	13,200	740	5	0.2	13,200	550	5	0.2	14,640	280	5	0.2
4025	2.5	11,400	840	6.25	0.25	11,400	640	6.25	0.25	13,200	390	6.25	0.25
4030	3	10,200	960	7.5	0.3	10,200	720	7.5	0.3	12,000	510	7.5	0.3
4040	4	8,640	1,350	10	0.8	8,040	1,000	10	0.8	9,000	730	10	0.4
4050	5	7,200	1,500	12.5	1	6,480	1,100	12.5	1	6,480	810	12.5	0.5
4060	6	6,000	1,600	15	1.2	5,400	1,200	15	1.2	5,400	810	15	0.6
4080	8	3,600	1,300	20	1.6	3,480	1,050	20	1.6	3,480	720	20	0.8
4010	10	1,920	1,000	25	2	1,800	900	25	2	1,800	580	25	1
4012	12	1,440	800	30	2.4	1,440	750	30	2.4	1,440	540	30	1.2
Milling Amount (mm)		a_p : All Flute a_e : 0.1D ($\phi D < 4$) a_e : 0.2D ($\phi D \geq 4$)				a_p : All Flute a_e : 0.1D ($\phi D < 4$) a_e : 0.2D ($\phi D \geq 4$)				a_p : All Flute a_e : 0.1D			

Side Milling

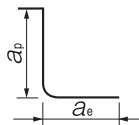

φ3mm Shank V Series

UDC-PCD Series

CBN Series

Square
Long Neck Square

Radius
Long Neck Radius

Taper Neck Radius

Ball / Long Shank Ball

Long Neck Ball

Taper Neck Ball

Taper

Barrel

Spiral V Cutter

Drill

Technical Data

Milling Conditions for CXERS

WORK MATERIAL		PREHARDENED STEELS HPM / NAK (30~45HRC)				HARDENED STEELS SKD / SKT / STAVAX (45~55HRC)			
Model Number	Outside Diameter (mm)	Spindle Speed (min ⁻¹)	Feed Rate (mm/min)	a_p Axial Depth (mm)	a_e Radial Depth (mm)	Spindle Speed (min ⁻¹)	Feed Rate (mm/min)	a_p Axial Depth (mm)	a_e Radial Depth (mm)
4010	1	15,480	250	2.5	0.1	12,900	180	2.5	0.05
4015	1.5	12,600	310	3.75	0.15	9,300	280	3.75	0.075
4020	2	11,220	360	5	0.2	7,600	390	5	0.1
4025	2.5	9,960	430	6.25	0.25	6,500	510	6.25	0.125
4030	3	8,880	500	7.5	0.3	5,900	500	7.5	0.3
4040	4	7,080	650	10	0.8	4,700	520	10	0.4
4050	5	5,760	680	12.5	1	3,850	530	12.5	0.5
4060	6	4,800	680	15	1.2	3,200	540	15	0.6
4080	8	3,000	600	20	1.6	2,000	500	20	0.8
4010	10	1,800	430	25	2	1,200	450	25	1
4012	12	1,200	320	30	2.4	960	420	30	1.2
Milling Amount (mm)		a_p : All Flute a_e : 0.1D ($\phi D < 4$) a_e : 0.2D ($\phi D \geq 4$)				a_p : All Flute a_e : 0.1D			

4 Flutes

ø3mm Shank
V Series

UDC-PCD
Series

CBN
Series

Square

Square

Long Neck
Square

Radius

Radius

Long Neck
Radius

Taper Neck
Radius

Ball

Ball / Long
Shank Ball

Long Neck
Ball

Taper Neck
Ball

Taper

Taper

Barrel

Spiral
V Cutter

Drill

Technical Data

Milling Conditions for CXERS

◆Slotting

WORK MATERIAL		CARBON STEELS S45C / S50C Annealed Materials (~225HB)			ALLOY STEELS SK / SCM Annealed Materials (225~325HB)			STAINLESS STEELS SUS304 ※Use water soluble or oil coolant.		
Model Number	Outside Diameter (mm)	Spindle Speed (min ⁻¹)	Feed Rate (mm/min)	a _p Axial Depth (mm)	Spindle Speed (min ⁻¹)	Feed Rate (mm/min)	a _p Axial Depth (mm)	Spindle Speed (min ⁻¹)	Feed Rate (mm/min)	a _p Axial Depth (mm)
4010	1	21,600	160	1	21,600	160	1	17,400	170	0.5
4015	1.5	16,200	250	1.5	16,200	220	1.5	15,960	190	0.75
4020	2	13,200	360	2	13,200	250	2	14,640	200	1
4025	2.5	11,400	430	2.5	11,400	280	2.5	13,200	240	1.25
4030	3	10,200	480	3	10,200	320	3	12,000	280	1.5
4040	4	8,640	650	4	8,040	450	4	9,000	400	2
4050	5	7,200	700	5	6,480	500	5	6,480	460	2.5
4060	6	6,000	700	6	5,400	500	6	5,400	460	3
4080	8	3,600	500	8	3,480	360	8	3,480	340	4
4100	10	1,920	380	10	1,800	270	10	1,800	220	5
4120	12	1,440	300	12	1,440	210	12	1,440	180	6
Milling Amount (mm)		a _p :1D			a _p :1D			a _p :0.5D		

Slotting

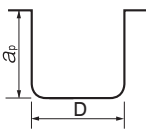

D : Outside Diameter (mm)

Note:

- Decrease both spindle speed and feed rate proportionally in case of chattering.
- These milling parameters are calculated based on the shortest overhang length. Longer overhangs may require an adjustment to the milling parameters.
- Reduce the milling amount and feed rate in accordance with required milling precision.
- Every coolant offers stable milling.
- Recommend water soluble or oil coolant for Stainless Steels and Copper.

Milling Conditions for CXERS

WORK MATERIAL		PREHARDENED STEELS HPM / NAK (30~45HRC)			HARDENED STEELS SKD / SKT / STAVAX (45~55HRC)		
Model Number	Outside Diameter (mm)	Spindle Speed (min ⁻¹)	Feed Rate (mm/min)	a_p Axial Depth (mm)	Spindle Speed (min ⁻¹)	Feed Rate (mm/min)	a_p Axial Depth (mm)
4010	1	15,480	100	1	12,900	50	0.3
4015	1.5	12,600	140	1.5	10,500	100	0.45
4020	2	11,220	170	2	9,350	150	0.6
4025	2.5	9,960	210	2.5	8,300	240	0.75
4030	3	8,880	250	3	7,400	360	1.5
4040	4	7,080	390	4	5,900	380	2
4050	5	5,760	440	5	4,800	410	2.5
4060	6	4,800	440	6	4,000	440	3
4080	8	3,000	340	8	2,500	340	4
4100	10	1,800	220	10	1,500	240	5
4120	12	1,200	180	12	1,200	220	6
Milling Amount (mm)		$a_p : 1D$			$a_p : 0.5D$		

4 Flutes

Ø3mm Shank
V Series

UDC-PCD
Series

CBN
Series

Square

Square

Long Neck
Square

Radius

Radius

Long Neck
Radius

Taper Neck
Radius

Ball

Ball / Long
Shank Ball

Long Neck
Ball

Taper Neck
Ball

Taper

Taper

Barrel

Spiral
V Cutter

Drill

Technical Data



Size $\phi 3 \sim \phi 12$

CXRS



$\phi 3 \sim \phi 6$ $\phi 8 \sim \phi 12$

Material Applications (★ Highly Recommended ● Recommended ○ Suggested)

Work Material																	
Carbon Steels S45C S55C	Alloy Steels SK / SCM SUS	Prehardened Steels NAK HPM	Hardened Steels					Cast Iron	Aluminum Alloys	Graphite	Copper	Plastics	Glass Filled Plastics	Titanium Alloys	Heat Resistant Alloys	Cemented Carbide	Hard Brittle (Non-Metallic) Materials
			~50HRC	~55HRC	~60HRC	~65HRC	~70HRC										
●	●	●	●	●				○	○		●			○	○		

Features

Recommended on a wide range of materials – Carbon Steels and Hardened steels up to 55 HRC. Variable pitch & helix design and positive rake angle offer highly efficient side milling. Seamless corner radius design greatly reduces cutting force.

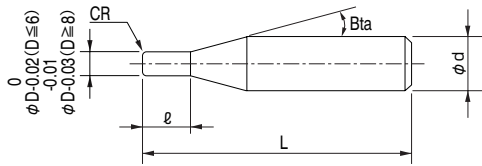

The shank taper angle shown is not an exact value and to avoid contact with the work piece, we recommend the user controls the precise value of this angle. Shank taper angle should not make contact with the work piece.

Variable Pitch

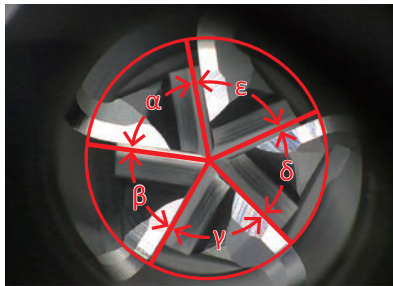

$\alpha \neq \beta \neq \gamma \neq \delta \neq \epsilon$

Corner Radius Design



Variable Helix

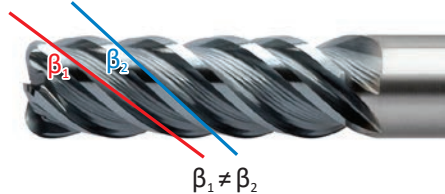

$\beta_1 \neq \beta_2$

- φ3mm Shank V Series
- UDC-PCD Series
- CBN Series
- Square
- Long Neck Square
- Radius
- Long Neck Radius
- Taper Neck Radius
- Ball / Long Shank Ball
- Long Neck Ball
- Taper Neck Ball
- Taper
- Barrel
- Spiral V Cutter
- Drill
- Technical Data

Total 30 models

Unit (mm)

Model Number	Outside Diameter ϕD	Corner Radius CR	Length of Cut ℓ	Shank Taper Angle Bta	Overall Length L	Shank Diameter ϕd	Suggested Retail Price ¥
CXRS 5030-05-0600	3	R0.5	6	16°	50	6	8,250
CXRS 5030-05-0900			9		50		
CXRS 5040-05-0800	4	R0.5	8	16°	60	6	8,900
CXRS 5040-05-1200			12		60		
CXRS 5040-10-0800		R1	8		60	6	8,900
CXRS 5040-10-1200			12		60		
CXRS 5060-05-1200	6	R0.5	12	—	70	6	9,600
CXRS 5060-05-1800			18		70		
CXRS 5060-10-1200		R1	12		70	6	9,600
CXRS 5060-10-1800			18		70		
CXRS 5080-05-1600	8	R0.5	16	—	70	8	13,800
CXRS 5080-05-2400			24		70		
CXRS 5080-10-1600		R1	16		70	8	13,800
CXRS 5080-10-2400			24		70		
CXRS 5100-05-2000	10	R0.5	20	—	80	10	16,800
CXRS 5100-05-3000			30		80		
CXRS 5100-10-2000		R1	20		80	10	16,800
CXRS 5100-10-3000			30		80		
CXRS 5100-15-2000		R1.5	20		80	10	16,800
CXRS 5100-15-3000			30		80		
CXRS 5100-20-2000		R2	20		80	10	16,800
CXRS 5100-20-3000			30		80		
CXRS 5120-05-2400	12	R0.5	24	—	80	12	22,000
CXRS 5120-05-3600			36		100		
CXRS 5120-10-2400		R1	24		80	12	22,000
CXRS 5120-10-3600			36		100		
CXRS 5120-15-2400		R1.5	24		80	12	22,000
CXRS 5120-15-3600			36		100		
CXRS 5120-20-2400		R2	24		80	12	22,000
CXRS 5120-20-3600			36		100		

5 Flutes

$\phi 3$ mm Shank V Series

UDC-PCD Series

CBN Series

Square
Square
Long Neck Square

Radius
Radius
Long Neck Radius
Taper Neck Radius

Ball / Long Shank Ball
Ball
Long Neck Ball

Taper Neck Ball

Taper
Taper

Barrel

Spiral V Cutter

Drill

Technical Data

Milling Conditions for CXRS

WORK MATERIAL			CARBON STEELS S45C / S50C Annealed Materials (~225HB)				ALLOY STEELS SK / SCM Annealed Materials (225~325HB)				PREHARDENED STEELS HPM / NAK (30~45HRC)				HARDENED STEELS SKD / SKT / STAVAX (45~55HRC)			
Model Number	Outside Diameter (mm)	Length of Cut (mm)	Spindle Speed (min ⁻¹)	Feed Rate (mm/min)	a _p Axial Depth (mm)	a _e Radial Depth (mm)	Spindle Speed (min ⁻¹)	Feed Rate (mm/min)	a _p Axial Depth (mm)	a _e Radial Depth (mm)	Spindle Speed (min ⁻¹)	Feed Rate (mm/min)	a _p Axial Depth (mm)	a _e Radial Depth (mm)	Spindle Speed (min ⁻¹)	Feed Rate (mm/min)	a _p Axial Depth (mm)	a _e Radial Depth (mm)
5030	3	6	20,000	10,000	6	0.3	20,000	10,000	6	0.3	20,000	10,000	6	0.09	20,000	12,000	6	0.06
		9	20,000	6,000	8	0.24	20,000	6,000	8	0.24	20,000	6,400	8	0.09	20,000	12,000	8	0.05
5040	4	8	18,200	9,100	8	0.4	18,200	9,100	8	0.4	19,800	9,900	8	0.12	15,000	11,500	8	0.08
		12	18,200	5,460	10.8	0.32	18,200	5,460	10.8	0.32	15,900	4,770	10.8	0.12	15,000	11,500	10.8	0.05
5060	6	12	12,200	6,100	12	0.6	12,200	6,100	12	0.6	13,200	6,500	12	0.21	10,000	7,600	12	0.15
		18	12,200	5,100	16	0.48	12,200	5,100	16	0.48	12,000	5,000	16	0.18	10,000	7,600	16	0.1
5080	8	16	9,100	4,550	16	0.8	9,100	4,550	16	0.8	9,900	4,950	16	0.4	7,600	5,600	16	0.2
		24	9,100	4,550	21	0.64	9,100	4,550	21	0.64	9,000	4,500	21	0.32	7,600	5,600	21	0.15
5100	10	20	7,300	3,650	20	1	7,300	3,650	20	1	8,000	4,600	20	0.5	6,000	4,500	20	0.25
		30	7,300	3,650	27	0.8	7,300	3,650	27	0.8	7,300	3,650	27	0.4	6,000	4,500	27	0.22
5120	12	24	6,100	3,050	24	1.2	6,100	3,050	24	1.2	6,600	3,960	24	0.6	5,000	3,800	24	0.3
		36	6,100	3,050	32	0.96	6,100	3,050	32	0.96	6,100	3,050	32	0.48	5,000	3,800	32	0.25

Note:

- Please be sure to use water soluble coolant.
- These milling parameters are for reference only.
- For best result, fine parameter adjustments may be required, depending on the milling shape / application / machine used and so on.
- Decrease both spindle speed and feed rate proportionally when the milling parameters exceed the machine's maximum spindle speed.
- WARNING: Because of high material removal rate, you must pay attention to your chip and coolant management.

Side Milling

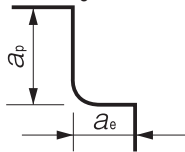

- φ3mm Shank V Series
- UDC-PCD Series
- CBN Series
- Square
- Long Neck Square
- Radius
- Long Neck Radius
- Taper Neck Radius
- Ball / Long Shank Ball
- Long Neck Ball
- Taper Neck Ball
- Taper
- Barrel
- Spiral V Cutter
- Drill
- Technical Data

5 Flutes v.s. 4 Flutes Comparison of Cutting Chips

STAVAX (53HRC)

Size : 140 x 200 mm
 Coolant : Oil Mist
 Milling Method : Side Milling
 Spindle Speed : 4,000 min⁻¹
 Feed Rate : 2,500 mm/min
 a_p : 20 mm
 a_e : 0.5 mm

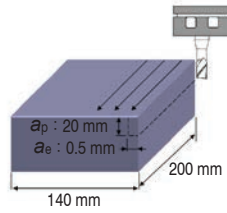

◆ 5 Flute Radius $\phi 10 \times CR0.5 \times L20$

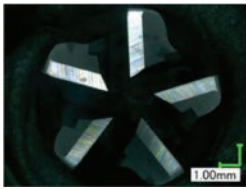

After 40 min



After 80 min

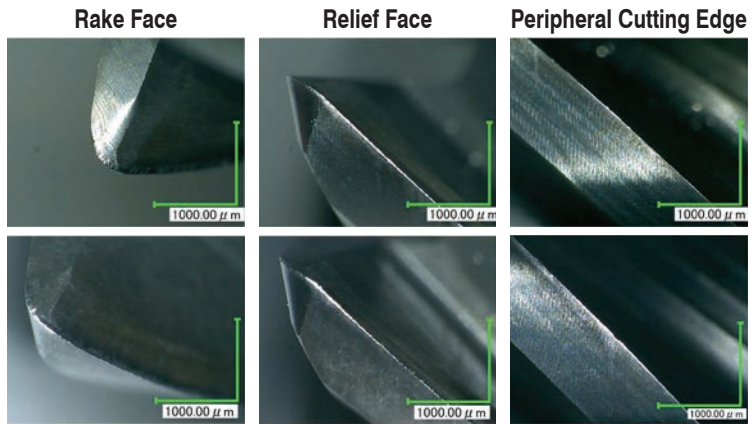

◆ 4 Flute Radius $\phi 10 \times CR1 \times L26$

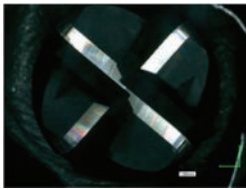

After 40 min



◆ Comparison of Cutting Chips

5 Flutes
Uniform cutting chips



4 Flutes
Irregular size cutting chips



5 flutes, variable pitch and variable helix design protect the tool from chattering and chipping under high-speed condition.

5 Flutes

$\phi 3$ mm Shank
V Series

UDC-PCD
Series

CBN
Series

Square

Long Neck
Square

Radius

Long Neck
Radius

Taper Neck
Radius

Ball / Long
Shank Ball

Long Neck
Ball

Taper Neck
Ball

Taper

Barrel

Spiral
V Cutter

Drill

Technical Data



Size $\phi 3 \sim \phi 12$

HMERS



Material Applications (★ Highly Recommended ● Recommended ○ Suggested)

Work Material																	
Carbon Steels	Alloy Steels	Prehardened Steels	Hardened Steels					Cast Iron	Aluminum Alloys	Graphite	Copper	Plastics	Glass Filled Plastics	Titanium Alloys	Heat Resistant Alloys	Cemented Carbide	Hard Brittle (Non-Metallic) Materials
			~50HRC	~55HRC	~60HRC	~65HRC	~70HRC										
S45C S55C	SK / SCM SUS	NAK HPM	○	●	●	●	●										

Features

Radius End Mills for Hard Materials.

4 and 6 Flutes have been applied to suitable sizes to offer outstandingly long tool life.

HARDMAX coat enables highly efficient milling for 65HRC High Speed Steels.

Various Corner Radius sizes available.

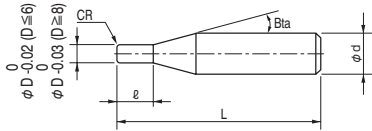

The shank taper angle shown is not an exact value and to avoid contact with the work piece, we recommend the user controls the precise value of this angle. Shank taper angle should not make contact with the work piece.

A lineup of 4 flutes and 6 flutes that considers high efficiency and chip evacuation performance according to the tool diameter.

$\phi 3 \sim \phi 5$ 4 flutes



$\phi 6 \sim \phi 12$ 6 flutes



Total 37 models

Unit (mm)

Model Number	Outside Diameter ϕD	Corner Radius CR	Length of Cut ℓ	Shank Taper Angle B_{α}	Overall Length L	Shank Diameter ϕd	Number of Flutes	Suggested Retail Price ¥
HMERS 4030-01-075	3	RO.1	7.5	16°	60	6	4	15,000
HMERS 4030-02-075		RO.2			60	6		15,000
HMERS 4030-03-075		RO.3			60	6		15,000
HMERS 4030-05-075		RO.5			60	6		15,000
HMERS 4040-01-100	4	RO.1	10	16°	60	6	4	16,200
HMERS 4040-02-100		RO.2			60	6		16,200
HMERS 4040-03-100		RO.3			60	6		16,200
HMERS 4040-05-100		RO.5			60	6		16,200
HMERS 4040-10-100		R1			60	6		16,200
HMERS 4050-01-125	5	RO.1	12.5	16°	60	6	4	17,400
HMERS 4050-02-125		RO.2			60	6		17,400
HMERS 4050-03-125		RO.3			60	6		17,400
HMERS 4050-05-125		RO.5			60	6		17,400
HMERS 4050-10-125		R1			60	6		17,400
HMERS 6060-01-130	6	RO.1	13	—	60	6	6	18,600
HMERS 6060-02-130		RO.2			60	6		18,600
HMERS 6060-03-130		RO.3			60	6		18,600
HMERS 6060-05-130		RO.5			60	6		18,600
HMERS 6060-10-130		R1			60	6		18,600
HMERS 6060-15-130		R1.5			60	6		18,600
HMERS 6080-02-190	8	RO.2	19	—	70	8	6	23,400
HMERS 6080-03-190		RO.3			70	8		23,400
HMERS 6080-05-190		RO.5			70	8		23,400
HMERS 6080-10-190		R1			70	8		23,400
HMERS 6080-20-190		R2			70	8		23,400
HMERS 6100-02-220	10	RO.2	22	—	80	10	6	31,800
HMERS 6100-03-220		RO.3			80	10		31,800
HMERS 6100-05-220		RO.5			80	10		31,800
HMERS 6100-10-220		R1			80	10		31,800
HMERS 6100-15-220		R1.5			80	10		31,800
HMERS 6100-20-220		R2			80	10		31,800
HMERS 6120-02-260	12	RO.2	26	—	100	12	6	38,400
HMERS 6120-03-260		RO.3			100	12		38,400
HMERS 6120-05-260		RO.5			100	12		38,400
HMERS 6120-10-260		R1			100	12		38,400
HMERS 6120-15-260		R1.5			100	12		38,400
HMERS 6120-20-260		R2			100	12		38,400

4 Flutes

6 Flutes

$\phi 3\text{mm}$ Shank V Series

UDC-PCD Series

CBN Series

Square

Long Neck Square

Radius

Long Neck Radius

Taper Neck Radius

Ball / Long Shank Ball

Long Neck Ball

Taper Neck Ball

Taper

Barrel

Spiral V Cutter

Drill

Technical Data

Milling Conditions for HMERS

WORK MATERIAL				PREHARDENED STEELS HARDENED STEELS (40~50HRC)				HARDENED STEELS (50~60HRC)				HARDENED STEELS (60HRC~)			
Model Number	Number of Flutes	Outside Diameter (mm)	Length of Cut (mm)	Spindle Speed (min ⁻¹)	Feed Rate (mm/min)	a_p Axial Depth (mm)	a_e Radial Depth (mm)	Spindle Speed (min ⁻¹)	Feed Rate (mm/min)	a_p Axial Depth (mm)	a_e Radial Depth (mm)	Spindle Speed (min ⁻¹)	Feed Rate (mm/min)	a_p Axial Depth (mm)	a_e Radial Depth (mm)
4030	4	3	7.5	13,100	1,680	6	0.06	4,200	720	6	0.06	8,600	465	6	0.06
4040	4	4	10	11,300	1,950	8	0.08	3,150	540	8	0.08	6,450	350	8	0.08
4050	4	5	12.5	10,100	2,300	10	0.1	2,520	430	10	0.1	5,160	280	10	0.1
6060	6	6	13	8,900	2,930	12	0.12	4,300	1,200	9	0.12	4,300	1,200	9	0.12
6080	6	8	19	4,000	2,400	12	0.24	3,220	1,450	12	0.08	3,220	1,450	12	0.08
6100	6	10	22	3,200	2,000	15	0.3	2,580	1,160	15	0.1	2,580	1,160	15	0.1
6120	6	12	26	2,670	1,600	18	0.36	2,150	970	18	0.12	2,150	970	18	0.12

Note:

- Recommend down cut processing.
- Reduce cutting amount, feed rate, and apply zero-cut in accordance with required surface quality.
- Recommend air blow or oil mist.

Side Milling

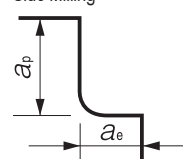

Side Milling Example HMERS $\phi 3 \times CR0.5 \times L7.5 / \phi 10 \times CR2 \times L22$

SKH51 (63 HRC)

Tools after Milling

4030-05-075

6100-20-220

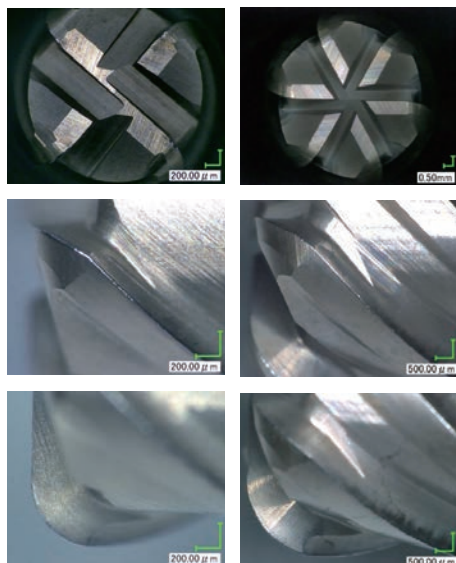

Tool	HMERS 4030-05-075 ($\phi 3 \times CR0.5$)	HMERS 6100-20-220 ($\phi 10 \times CR2$)
Spindle Speed	8,600 min ⁻¹	2,580 min ⁻¹
Feed Rate	465 mm/min	1,160 mm/min
a_p	6 mm	15 mm
a_e	0.06 mm	0.1 mm
Milling Distance	12.7 m	28 m
Coolant	Air Blow (Through Spindle)	

Milling Image

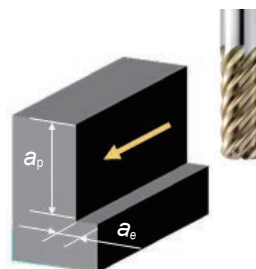

Side Milling (Down-cut)

**No chipping when milling Hard Materials.
More tool life left.**

HMERS $\phi 10 \times CR1 \times L22$ Milling example

SKD11 (59HRC)

1. Deflection amount and surface roughness

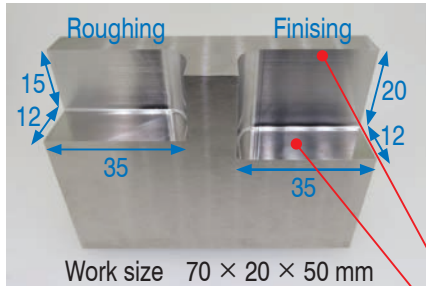

Deflection amount (Right side finishing)

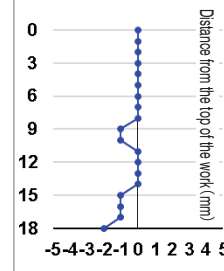

Wall surface Ra 0.21 μm
Bottom surface Ra 0.04 μm

Coolant: Air blow (Through spindle)
Milling direction: Down cut

Tool
HMERS $\phi 10 \times CR1 \times L22$



	Process	Spindle Speed (min ⁻¹)	Feed Rate (mm/min)	a_p (mm)	a_e (mm)	Allowance (mm)	Cycle Time (h:m:s)
Roughing	Roughing	2,580	1,160	15	0.10	0	0:05:22
Right side of work	Roughing	2,580	1,160	20	0.05	0.05	0:10:38
	Semi-Roughing		580	20	0.04	0.01	0:25:11
	Finishing				0.01	0	1:40:43

Right side total 2:16:32

2. Corner Radius measurement

R1

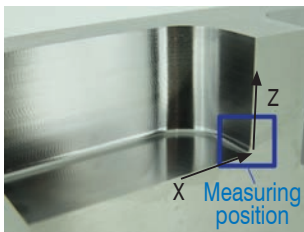

Corner R1

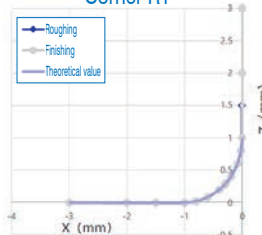

Radius accuracy (mm)
Roughing -0.003/0.006
Finishing 0/0.007

High-precision machining is possible even with the bottom R.

4 Flutes

6 Flutes

$\phi 3\text{mm}$ Shank V Series

UDC-PCD Series

CBN Series

Square

Long Neck Square

Radius

Long Neck Radius

Taper Neck Radius

Ball / Long Shank Ball

Long Neck Ball

Taper Neck Ball

Taper

Barrel

Spiral V Cutter

Drill

Technical Data



Size $\phi 0.2 \sim \phi 6$

HLRS2000/HLRS2000E



Material Applications (★ Highly Recommended ● Recommended ○ Suggested)

Work Material																	
Carbon Steels S45C S55C	Alloy Steels SK / SCM SUS	Prehardened Steels NAK HPM	Hardened Steels					Cast Iron	Aluminum Alloys	Graphite	Copper	Plastics	Glass Filled Plastics	Titanium Alloys	Heat Resistant Alloys	Cemented Carbide	Hard Brittle (Non-Metallic) Materials
			~50HRC	~55HRC	~60HRC	~65HRC	~70HRC										
○	○	●	●	●	●	○								○	○		

Total 353 models

Unit (mm)

Model Number	Excellent	Outside Diameter ϕD	Corner Radius CR	Effective Length ℓ_1	Length of Cut ℓ	Neck Diameter ϕd_1	Shank Taper Angle Bta	Overall Length L	Shank Diameter ϕd	Suggested Retail Price ¥			
HLRS 2002-005-005E	○	0.2	RO.05	0.5	0.2	0.17	16°	50	4	12,320			
HLRS 2002-005-010E	○			1				50	4	12,320			
HLRS 2002-005-015E	○			1.5				50	4	12,320			
HLRS 2002-005-020E	○			2				50	4	12,320			
HLRS 2003-005-010E	○	0.3	RO.05	1	0.3	0.27	16°	50	4	11,870			
HLRS 2003-005-015E	○			1.5				50	4	11,870			
HLRS 2003-005-020E	○			2				50	4	11,870			
HLRS 2003-005-025E	○			2.5				50	4	13,200			
HLRS 2003-005-030E	○			3				50	4	13,200			
HLRS 2004-005-010E	○			1				0.4	0.4	0.38	16°	50	4
HLRS 2004-005-015E	○	1.5	50	4	7,910								
HLRS 2004-005-020E	○	2	50	4	7,910								
HLRS 2004-005-030E	○	3	50	4	7,910								
HLRS 2004-005-040E	○	4	50	4	7,910								
HLRS 2004-01-010		1	0.5	0.5	0.48	16°	50					4	7,910
HLRS 2004-01-015		1.5					50					4	7,910
HLRS 2004-01-020		2					50					4	7,910
HLRS 2004-01-030		3					50					4	7,910
HLRS 2004-01-040		4					50					4	7,910
HLRS 2005-005-010		1					RO.05	0.5	0.48	16°	50	4	6,440
HLRS 2005-005-020		2									50	4	6,440
HLRS 2005-005-030		3									50	4	6,440
HLRS 2005-005-040		4									50	4	6,440
HLRS 2005-005-050		5									50	4	6,440
HLRS 2005-01-010		1	RO.1	0.5	0.48	16°	50	4	6,440				
HLRS 2005-01-020		2					50	4	6,440				
HLRS 2005-01-030		3					50	4	6,440				
HLRS 2005-01-040		4					50	4	6,440				
HLRS 2005-01-050		5					50	4	6,440				
HLRS 2005-01-060		6					50	4	6,440				

Next Page ➔

Features

Long Neck Radius design for high efficiency and high quality milling.
Recommended for various applications from Copper and Raw Materials to Hard Materials.
Both dry and wet coolant offer stable and long tool life.
Refer to page 358 for 4 flute HLRS.

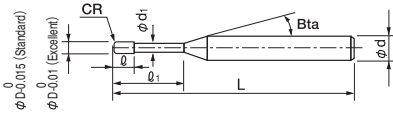
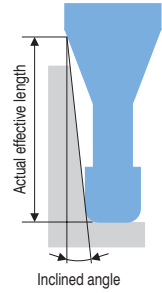

The shank taper angle shown is not an exact value and to avoid contact with the work piece, we recommend the user controls the precise value of this angle. Shank taper angle should not make contact with the work piece.

	Diameter Tolerance	Corner Radius Tolerance
Standard Tolerance Type	0/-0.015	Nominal Radius ± 0.005
Excellent Tolerance Type	0/-0.01	Nominal Radius ± 0.005

Unit (mm)

Model Number	Excellent	Outside Diameter ϕD	Corner Radius CR	Effective Length ℓ_1	Effective Length by Inclined Angles				
					30'	1°	1°30'	2°	3°
HLRS 2002-005-005E	○	0.2	RO.05	0.5	0.67	0.71	0.75	0.78	0.85
HLRS 2002-005-010E	○			1	1.20	1.26	1.31	1.36	1.45
HLRS 2002-005-015E	○			1.5	1.72	1.80	1.87	1.92	2.03
HLRS 2002-005-020E	○			2	2.25	2.34	2.41	2.48	2.59
HLRS 2003-005-010E	○	0.3	RO.05	1	1.24	1.31	1.38	1.44	1.55
HLRS 2003-005-015E	○			1.5	1.72	1.83	1.91	1.99	2.12
HLRS 2003-005-020E	○			2	2.26	2.37	2.47	2.55	2.70
HLRS 2003-005-025E	○			2.5	2.78	2.91	3.02	3.11	3.27
HLRS 2003-005-030E	○	0.4	RO.05	3	3.31	3.45	3.57	3.66	3.83
HLRS 2004-005-010E	○			1	1.31	1.40	1.49	1.57	1.72
HLRS 2004-005-015E	○			1.5	1.79	1.92	2.03	2.13	2.31
HLRS 2004-005-020E	○			2	2.33	2.48	2.60	2.71	2.90
HLRS 2004-005-030E	○	RO.1	RO.1	3	3.40	3.58	3.72	3.85	4.07
HLRS 2004-005-040E	○			4	4.45	4.66	4.82	4.97	5.21
HLRS 2004-01-010				1	1.28	1.38	1.46	1.55	1.69
HLRS 2004-01-015				1.5	1.76	1.90	2.01	2.11	2.28
HLRS 2004-01-020		RO.05	RO.05	2	2.30	2.46	2.58	2.69	2.89
HLRS 2004-01-030				3	3.38	3.56	3.71	3.83	4.06
HLRS 2004-01-040				4	4.44	4.64	4.81	4.95	5.20
HLRS 2005-005-010				1	1.34	1.46	1.57	1.67	1.86
HLRS 2005-005-020		RO.1	RO.1	2	2.37	2.55	2.71	2.84	3.08
HLRS 2005-005-030				3	3.45	3.67	3.85	4.00	4.27
HLRS 2005-005-040				4	4.52	4.77	4.97	5.14	5.44
HLRS 2005-005-050				5	5.58	5.85	6.07	6.26	6.58
HLRS 2005-01-010		0.5	RO.1	1	1.34	1.45	1.56	1.66	1.85
HLRS 2005-01-020				2	2.37	2.55	2.70	2.83	3.07
HLRS 2005-01-030				3	3.45	3.67	3.84	4.00	4.26
HLRS 2005-01-040				4	4.52	4.76	4.96	5.13	5.43
HLRS 2005-01-050				5	5.58	5.85	6.07	6.25	6.57
HLRS 2005-01-060				6	6.63	6.93	7.16	7.36	7.70

Next Page →

- 3mm Shank V Series
- UDC-PCD Series
- CBN Series
- Square
- Long Neck Square
- Radius
- Long Neck Radius
- Taper Neck Radius
- Ball / Long Shank Ball
- Long Neck Ball
- Taper Neck Ball
- Taper
- Taper
- Barrel
- Spiral V Cutter
- Drill
- Technical Data

Model Number	Excellent	Outside Diameter ϕD	Corner Radius CR	Effective Length ℓ_1	Length of Cut ℓ	Neck Diameter ϕd_1	Shank Taper Angle Bta	Overall Length L	Shank Diameter ϕd	Suggested Retail Price ¥	
HLRS 2006-005-020		0.6	RO.05	2	0.6	0.58	16°	50	4	6,440	
HLRS 2006-005-030				3				6,440			
HLRS 2006-005-040				4				6,440			
HLRS 2006-005-060				6				6,440			
HLRS 2006-005-080				8				6,440			
HLRS 2006-01-020				RO.1				2	50	4	6,440
HLRS 2006-01-020E	○		2					50	4	7,080	
HLRS 2006-01-030			3					50	4	6,440	
HLRS 2006-01-030E	○		3					50	4	7,080	
HLRS 2006-01-040			4					50	4	6,440	
HLRS 2006-01-040E	○		4					50	4	7,080	
HLRS 2006-01-060			6					50	4	6,440	
HLRS 2006-01-080			8					50	4	6,440	
HLRS 2006-02-020			RO.2					2	50	4	6,440
HLRS 2006-02-030								3	50	4	6,440
HLRS 2006-02-040				4				50	4	6,440	
HLRS 2006-02-060		6		50	4	6,440					
HLRS 2006-02-080		8	50	4	6,440						
HLRS 2007-01-040		0.7	RO.1	4	0.7	0.68	16°	50	4	6,780	
HLRS 2007-01-060				6				50	4	6,780	
HLRS 2007-02-040			RO.2	4				50	4	6,780	
HLRS 2007-02-060				6				50	4	6,780	
HLRS 2008-005-040		0.8	RO.05	4	0.8	0.78	16°	50	4	7,340	
HLRS 2008-005-060				6				50	4	7,340	
HLRS 2008-005-080				8				50	4	7,340	
HLRS 2008-01-040				RO.1				4	50	4	7,340
HLRS 2008-01-060			6					50	4	7,340	
HLRS 2008-01-080			8					50	4	7,340	
HLRS 2008-02-040			RO.2	4				50	4	7,340	
HLRS 2008-02-060				6				50	4	7,340	
HLRS 2008-02-080				8				50	4	7,340	
HLRS 2010-005-020				1				RO.05	2	1	0.95
HLRS 2010-005-030		3	50		4	6,240					
HLRS 2010-005-040		4	50		4	6,240					
HLRS 2010-005-050		5	50		4	6,240					
HLRS 2010-005-060		6	50		4	6,780					
HLRS 2010-005-080		8	50		4	6,780					
HLRS 2010-005-100		10	50		4	6,780					
HLRS 2010-005-120		12	55		4	6,780					
HLRS 2010-005-160		16	60		4	8,990					
HLRS 2010-005-200		20	60		4	9,980					
HLRS 2010-01-020		RO.1	2		50	4	6,240				
HLRS 2010-01-020E	○		2		50	4	6,860				
HLRS 2010-01-030			3		50	4	6,240				
HLRS 2010-01-040			4		50	4	6,240				
HLRS 2010-01-040E	○		4		50	4	6,860				
HLRS 2010-01-050			5		50	4	6,240				
HLRS 2010-01-060			6		50	4	6,780				
HLRS 2010-01-060E	○		6		50	4	7,460				

- 3mm Shank V Series
- UDC-PCD Series
- CBN Series
- Square
- Long Neck Square
- Radius
- Long Neck Radius
- Taper Neck Radius
- Ball / Long Shank Ball
- Long Neck Ball
- Taper Neck Ball
- Taper
- Barrel
- Spiral V Cutter
- Drill
- Technical Data

Model Number	Excellent	Outside Diameter ϕD	Corner Radius CR	Effective Length l_1	Effective Length by Inclined Angles					
					30°	1°	1°30'	2°	3°	
HLRS 2006-005-020		0.6	RO.05	2	2.38	2.61	2.79	2.95	3.22	
HLRS 2006-005-030				3	3.48	3.74	3.95	4.13	4.30	
HLRS 2006-005-040				4	4.56	4.85	5.08	5.28	5.67	
HLRS 2006-005-060				6	6.68	7.03	7.30	7.55	8.12	
HLRS 2006-005-080				8	8.79	9.18	9.50	9.83	10.56	
HLRS 2006-01-020			RO.1	2	2.37	2.60	2.78	2.93	3.20	
HLRS 2006-01-020E	○			2	2.37	2.60	2.78	2.93	3.20	
HLRS 2006-01-030				3	3.47	3.73	3.94	4.11	4.28	
HLRS 2006-01-030E	○			3	3.47	3.73	3.94	4.11	4.28	
HLRS 2006-01-040				4	4.55	4.84	5.07	5.26	5.65	
HLRS 2006-01-040E	○			4	4.55	4.84	5.07	5.26	5.65	
HLRS 2006-01-060				6	6.68	7.03	7.30	7.54	8.10	
HLRS 2006-01-080				8	8.79	9.18	9.50	9.82	10.55	
HLRS 2006-02-020				RO.2	2	2.34	2.56	2.74	2.90	3.18
HLRS 2006-02-030					3	3.44	3.70	3.91	4.09	4.41
HLRS 2006-02-040			4		4.53	4.82	5.05	5.23	5.61	
HLRS 2006-02-060			6		6.66	7.01	7.28	7.51	8.06	
HLRS 2006-02-080			8		8.79	9.17	9.48	9.81	10.53	
HLRS 2007-01-040			0.7	RO.1	4	4.55	4.84	5.07	5.26	5.65
HLRS 2007-01-060					6	6.68	7.03	7.30	7.54	8.10
HLRS 2007-02-040		RO.2		4	4.53	4.82	5.05	5.23	5.61	
HLRS 2007-02-060				6	6.66	7.01	7.28	7.51	8.06	
HLRS 2008-005-040		0.8	RO.05	4	4.56	4.85	5.08	5.28	5.67	
HLRS 2008-005-060				6	6.68	7.03	7.30	7.55	8.12	
HLRS 2008-005-080				8	8.79	9.18	9.50	9.83	10.56	
HLRS 2008-01-040			RO.1	4	4.55	4.84	5.07	5.26	5.65	
HLRS 2008-01-060				6	6.68	7.03	7.30	7.54	8.10	
HLRS 2008-01-080				8	8.79	9.18	9.50	9.82	10.55	
HLRS 2008-02-040			RO.2	4	4.53	4.82	5.05	5.23	5.61	
HLRS 2008-02-060				6	6.66	7.01	7.28	7.51	8.06	
HLRS 2008-02-080				8	8.79	9.17	9.48	9.81	10.53	
HLRS 2010-005-020				1	RO.05	2	2.51	2.86	2.70	3.01
HLRS 2010-005-030		3	3.59			3.82	4.01	4.18	4.51	
HLRS 2010-005-040		4	4.72			4.92	5.14	5.33	5.73	
HLRS 2010-005-050		5	5.72			6.01	6.25	6.47	6.95	
HLRS 2010-005-060		6	6.77			7.09	7.35	7.61	8.18	
HLRS 2010-005-080		8	8.87			9.24	9.55	9.88	10.62	
HLRS 2010-005-100		10	10.97			11.37	11.75	12.16	13.07	
HLRS 2010-005-120		12	13.05			13.50	13.96	14.44	15.52	
HLRS 2010-005-160		16	17.20			17.76	18.36	18.99	20.41	
HLRS 2010-005-200		20	21.33			22.02	22.76	23.55	25.31	
HLRS 2010-01-020		RO.1	2		2.53	2.71	2.88	3.01	3.27	
HLRS 2010-01-020E	○		2		2.53	2.71	2.88	3.01	3.27	
HLRS 2010-01-030			3		3.58	3.81	4.00	4.18	4.49	
HLRS 2010-01-040			4		4.67	4.93	5.14	5.33	5.72	
HLRS 2010-01-040E	○		4		4.67	4.93	5.14	5.33	5.72	
HLRS 2010-01-050			5		5.71	6.00	6.24	6.46	6.94	
HLRS 2010-01-060			6		6.78	7.10	7.36	7.60	8.17	
HLRS 2010-01-060E	○		6		6.78	7.10	7.36	7.60	8.17	

Unit (mm)

Model Number	Excellent	Outside Diameter ϕD	Corner Radius CR	Effective Length l_1	Length of Cut l	Neck Diameter ϕd_1	Shank Taper Angle Bta	Overall Length L	Shank Diameter ϕd	Suggested Retail Price ¥				
HLRS 2010-01-080		1	RO.1	8	1	0.95	16°	50	4	6,780				
HLRS 2010-01-100				10				50	4	6,780				
HLRS 2010-01-120				12				55	4	6,780				
HLRS 2010-01-160				16				60	4	8,990				
HLRS 2010-01-200				20				60	4	9,980				
HLRS 2010-02-020			1	RO.2				2	1	0.95	16°	50	4	6,240
HLRS 2010-02-020E	○							2				50	4	6,860
HLRS 2010-02-030								3				50	4	6,240
HLRS 2010-02-040								4				50	4	6,240
HLRS 2010-02-040E	○							4				50	4	6,860
HLRS 2010-02-050				5				50				4	6,240	
HLRS 2010-02-060				RO.2				6				50	4	6,780
HLRS 2010-02-060E	○							6				50	4	7,460
HLRS 2010-02-080								8				50	4	6,780
HLRS 2010-02-100								10				50	4	6,780
HLRS 2010-02-120								12				55	4	6,780
HLRS 2010-02-160				16				60				4	8,990	
HLRS 2010-02-200				20				60				4	9,980	
HLRS 2010-03-020				RO.3				2				50	4	6,240
HLRS 2010-03-020E	○							2				50	4	6,860
HLRS 2010-03-030		3			50	4	6,240							
HLRS 2010-03-040		4			50	4	6,240							
HLRS 2010-03-040E	○	4			50	4	6,860							
HLRS 2010-03-050		5			50	4	6,240							
HLRS 2010-03-060		6			50	4	6,780							
HLRS 2010-03-060E	○	6	50		4	7,460								
HLRS 2010-03-080		8	50		4	6,780								
HLRS 2010-03-100		10	50		4	6,780								
HLRS 2010-03-120		12	55	4	6,780									
HLRS 2010-03-160		16	60	4	8,990									
HLRS 2010-03-200		20	60	4	9,980									
HLRS 2012-02-060		1.2	RO.2	6	1.2	1.14	16°	50	4	7,000				
HLRS 2012-02-120				12				55	4	7,000				
HLRS 2012-02-200				20				60	4	10,620				
HLRS 2012-03-060			RO.3	6				50	4	7,000				
HLRS 2012-03-120				12				55	4	7,000				
HLRS 2012-03-200		20	60	4	10,620									
HLRS 2015-005-040		1.5	RO.05	4	1.5	1.45	16°	50	4	6,650				
HLRS 2015-005-060				6				50	4	6,650				
HLRS 2015-005-080				8				50	4	7,000				
HLRS 2015-005-100				10				50	4	7,000				
HLRS 2015-01-040			RO.1	4				50	4	6,650				
HLRS 2015-01-060				6				50	4	6,650				
HLRS 2015-01-080				8				50	4	7,000				
HLRS 2015-01-100				10				50	4	7,000				
HLRS 2015-01-120				12				55	4	7,000				
HLRS 2015-01-160				16				55	4	7,000				
HLRS 2015-01-200		20	60	4	7,000									

- 3mm Shank V Series
- UDC-PCD Series
- CBN Series
- Square
- Long Neck Square
- Radius
- Long Neck Radius
- Taper Neck Radius
- Ball / Long Shank Ball
- Long Neck Ball
- Taper Neck Ball
- Taper
- Barrel
- Spiral V Cutter
- Drill
- Technical Data

Model Number	Excellent	Outside Diameter ϕD	Corner Radius CR	Effective Length l_1	Effective Length by Inclined Angles					
					30°	1°	1°30'	2°	3°	
HLRS 2010-01-080		1	RO.1	8	8.88	9.24	9.56	9.88	10.61	
HLRS 2010-01-100				10	10.97	11.37	11.76	12.16	13.06	
HLRS 2010-01-120				12	13.05	13.50	13.96	14.44	15.51	
HLRS 2010-01-160				16	17.20	17.76	18.36	18.99	20.40	
HLRS 2010-01-200				20	21.33	22.02	22.76	23.54	25.30	
HLRS 2010-02-020				RO.2	2	2.51	2.69	2.86	2.98	3.23
HLRS 2010-02-020E	○		2		2.51	2.69	2.86	2.98	3.23	
HLRS 2010-02-030			3		3.58	3.80	3.99	4.16	4.47	
HLRS 2010-02-040			4		4.65	4.91	5.12	5.30	5.68	
HLRS 2010-02-040E	○		4		4.65	4.91	5.12	5.30	5.68	
HLRS 2010-02-050			5		5.71	6.00	6.23	6.45	6.92	
HLRS 2010-02-060			6		6.76	7.08	7.34	7.57	8.13	
HLRS 2010-02-060E	○		6		6.76	7.08	7.34	7.57	8.13	
HLRS 2010-02-080			8		8.86	9.22	9.54	9.85	10.57	
HLRS 2010-02-100			10		10.95	11.35	11.74	12.13	13.02	
HLRS 2010-02-120			12		13.03	13.48	13.94	14.41	15.47	
HLRS 2010-02-160			16		17.18	17.74	18.34	18.96	20.36	
HLRS 2010-02-200			20		21.31	22.00	22.74	23.51	25.26	
HLRS 2010-03-020			RO.3		2	2.49	2.67	2.84	2.95	3.19
HLRS 2010-03-020E	○				2	2.49	2.67	2.84	2.95	3.19
HLRS 2010-03-030					3	3.57	3.79	3.98	4.14	4.45
HLRS 2010-03-040					4	4.63	4.89	5.10	5.27	5.64
HLRS 2010-03-040E	○				4	4.63	4.89	5.10	5.27	5.64
HLRS 2010-03-050				5	5.70	5.99	6.22	6.43	6.90	
HLRS 2010-03-060				6	6.74	7.06	7.32	7.54	8.09	
HLRS 2010-03-060E	○			6	6.74	7.06	7.32	7.54	8.09	
HLRS 2010-03-080				8	8.84	9.20	9.52	9.82	10.53	
HLRS 2010-03-100				10	10.93	11.33	11.72	12.10	12.98	
HLRS 2010-03-120				12	13.01	13.46	13.92	14.38	15.43	
HLRS 2010-03-160				16	17.16	17.72	18.32	18.93	20.32	
HLRS 2010-03-200			20	21.29	21.98	22.72	23.48	25.22		
HLRS 2012-02-060			1.2	RO.2	6	6.18	6.38	6.59	6.82	7.33
HLRS 2012-02-120					12	12.37	12.77	13.19	13.65	14.67
HLRS 2012-02-200					20	20.62	21.29	22.00	22.76	24.46
HLRS 2012-03-060				RO.3	6	6.18	6.38	6.59	6.81	7.31
HLRS 2012-03-120					12	12.37	12.77	13.19	13.64	14.66
HLRS 2012-03-200		20			20.62	21.28	21.99	22.75	24.45	
HLRS 2015-005-040		1.5	RO.05	4	4.12	4.26	4.40	4.55	4.89	
HLRS 2015-005-060				6	6.18	6.39	6.60	6.83	7.34	
HLRS 2015-005-080				8	8.25	8.52	8.80	9.11	9.79	
HLRS 2015-005-100				10	10.31	10.64	11.00	11.38	12.24	
HLRS 2015-01-040				RO.1	4	4.12	4.25	4.40	4.55	4.89
HLRS 2015-01-060					6	6.18	6.38	6.60	6.83	7.34
HLRS 2015-01-080			8		8.24	8.51	8.80	9.10	9.78	
HLRS 2015-01-100			10		10.31	10.64	11.00	11.38	12.23	
HLRS 2015-01-120			12		12.37	12.77	13.20	13.66	14.68	
HLRS 2015-01-160			16		16.50	17.03	17.60	18.21	19.57	
HLRS 2015-01-200			20		20.62	21.29	22.00	22.77	No Interference	

3mm Shank
V Series

UDC-PCD
Series

CBN
Series

Square
Long Neck
Square

Radius
Long Neck
Radius

Taper Neck
Radius

Ball / Long
Shank Ball

Long Neck
Ball

Taper Neck
Ball

Taper

Barrel

Spiral
V Cutter

Drill

Technical Data

Model Number	Excellent	Outside Diameter ϕD	Corner Radius CR	Effective Length ℓ_1	Length of Cut ℓ	Neck Diameter ϕd_1	Shank Taper Angle Bta	Overall Length L	Shank Diameter ϕd	Suggested Retail Price ¥	
HLRS 2015-02-040		1.5	RO.2	4	1.5	1.45	16°	50	4	6,650	
HLRS 2015-02-060				6				50	4	6,650	
HLRS 2015-02-080				8				50	4	7,000	
HLRS 2015-02-100				10				50	4	7,000	
HLRS 2015-02-120				12				55	4	7,000	
HLRS 2015-02-160				16				55	4	7,000	
HLRS 2015-02-200				20				60	4	7,000	
HLRS 2015-03-040				RO.3				4	50	4	6,650
HLRS 2015-03-060			6					50	4	6,650	
HLRS 2015-03-080			8					50	4	7,000	
HLRS 2015-03-100			10					50	4	7,000	
HLRS 2015-03-120			12					55	4	7,000	
HLRS 2015-03-160			16					55	4	7,000	
HLRS 2015-03-200			20					60	4	7,000	
HLRS 2015-05-040			RO.5					4	50	4	6,650
HLRS 2015-05-060				6				50	4	6,650	
HLRS 2015-05-080				8				50	4	7,000	
HLRS 2015-05-100				10				50	4	7,000	
HLRS 2015-05-120				12				55	4	7,000	
HLRS 2015-05-160				16				55	4	7,000	
HLRS 2015-05-200		20		60	4	7,000					
HLRS 2020-005-040		2		RO.05	4	2	1.92	16°	50	4	6,650
HLRS 2020-005-060			6		50				4	6,650	
HLRS 2020-005-080			8		50				4	7,000	
HLRS 2020-005-100			10		50				4	7,000	
HLRS 2020-01-040			4		50				4	6,650	
HLRS 2020-01-040E	○		4	50	4				7,320		
HLRS 2020-01-060			6	50	4				6,650		
HLRS 2020-01-060E	○		6	50	4				7,320		
HLRS 2020-01-080			8	50	4				7,000		
HLRS 2020-01-080E	○		8	50	4				7,700		
HLRS 2020-01-100			RO.1	10	50				4	7,000	
HLRS 2020-01-100E	○			10	50				4	7,700	
HLRS 2020-01-120				12	55				4	7,000	
HLRS 2020-01-120E	○			12	55				4	7,700	
HLRS 2020-01-160				16	60				4	7,000	
HLRS 2020-01-200				20	60				4	7,000	
HLRS 2020-01-260				26	70				4	7,000	
HLRS 2020-01-300				30	70				4	7,000	
HLRS 2020-02-040				RO.2	4				50	4	6,650
HLRS 2020-02-040E	○				4				50	4	7,320
HLRS 2020-02-060		6	50		4	6,650					
HLRS 2020-02-060E	○	6	50		4	7,320					
HLRS 2020-02-080		8	50		4	7,000					
HLRS 2020-02-080E	○	8	50		4	7,700					
HLRS 2020-02-100		10	50		4	7,000					
HLRS 2020-02-100E	○	10	50		4	7,700					

- 3mm Shank V Series
- UDC-PCD Series
- CBN Series
- Square
- Long Neck Square
- Radius
- Long Neck Radius
- Taper Neck Radius
- Ball / Long Shank Ball
- Long Neck Ball
- Taper Neck Ball
- Taper
- Barrel
- Spiral V Cutter
- Drill
- Technical Data

Model Number	Excellent	Outside Diameter ϕD	Corner Radius CR	Effective Length l_1	Effective Length by Inclined Angles					
					30°	1°	1°30'	2°	3°	
HLRS 2015-02-040		1.5	RO.2	4	4.12	4.25	4.39	4.54	4.88	
HLRS 2015-02-060				6	6.18	6.38	6.59	6.82	7.33	
HLRS 2015-02-080				8	8.24	8.51	8.79	9.10	9.77	
HLRS 2015-02-100				10	10.31	10.64	10.99	11.37	12.22	
HLRS 2015-02-120				12	12.37	12.77	13.19	13.65	14.67	
HLRS 2015-02-160				16	16.49	17.03	17.60	18.21	19.56	
HLRS 2015-02-200				20	20.62	21.29	22.00	22.76	No Interference	
HLRS 2015-03-040				RO.3	4	4.12	4.25	4.39	4.54	4.87
HLRS 2015-03-060			6		6.18	6.38	6.59	6.81	7.31	
HLRS 2015-03-080			8		8.24	8.51	8.79	9.09	9.76	
HLRS 2015-03-100			10		10.30	10.64	10.99	11.37	12.21	
HLRS 2015-03-120			12		12.37	12.77	13.19	13.64	14.66	
HLRS 2015-03-160			16		16.49	17.02	17.59	18.20	19.55	
HLRS 2015-03-200			20		20.62	21.28	21.99	22.75	No Interference	
HLRS 2015-05-040			RO.5		4	4.11	4.24	4.38	4.52	4.85
HLRS 2015-05-060				6	6.18	6.37	6.58	6.80	7.29	
HLRS 2015-05-080				8	8.24	8.50	8.78	9.08	9.74	
HLRS 2015-05-100				10	10.30	10.63	10.98	11.35	12.19	
HLRS 2015-05-120				12	12.36	12.76	13.18	13.63	14.64	
HLRS 2015-05-160				16	16.49	17.02	17.58	18.19	19.53	
HLRS 2015-05-200		20		20.62	21.28	21.98	22.74	24.42		
HLRS 2020-005-040		2		RO.05	4	4.16	4.29	4.44	4.59	4.94
HLRS 2020-005-060			6		6.22	6.42	6.64	6.87	7.38	
HLRS 2020-005-080			8		8.28	8.55	8.84	9.15	9.83	
HLRS 2020-005-100			10		10.35	10.68	11.04	11.42	12.28	
HLRS 2020-01-040			RO.1	4	4.16	4.29	4.43	4.59	4.93	
HLRS 2020-01-040E	○			4	4.16	4.29	4.43	4.59	4.93	
HLRS 2020-01-060				6	6.22	6.42	6.64	6.87	7.38	
HLRS 2020-01-060E	○			6	6.22	6.42	6.64	6.87	7.38	
HLRS 2020-01-080				8	8.28	8.55	8.84	9.14	9.83	
HLRS 2020-01-080E	○			8	8.28	8.55	8.84	9.14	9.83	
HLRS 2020-01-100				10	10.34	10.68	11.04	11.42	12.27	
HLRS 2020-01-100E	○			10	10.34	10.68	11.04	11.42	12.27	
HLRS 2020-01-120				12	12.41	12.81	13.24	13.70	14.72	
HLRS 2020-01-120E	○			12	12.41	12.81	13.24	13.70	14.72	
HLRS 2020-01-160				16	16.53	17.07	17.64	18.25	No Interference	
HLRS 2020-01-200				20	20.66	21.33	22.04	22.81	No Interference	
HLRS 2020-01-260				26	26.85	27.72	28.65	No Interference	No Interference	
HLRS 2020-01-300				30	30.97	31.98	33.05	No Interference	No Interference	
HLRS 2020-02-040				RO.2	4	4.15	4.29	4.43	4.58	4.92
HLRS 2020-02-040E	○				4	4.15	4.29	4.43	4.58	4.92
HLRS 2020-02-060		6	6.22		6.42	6.63	6.86	7.37		
HLRS 2020-02-060E	○	6	6.22		6.42	6.63	6.86	7.37		
HLRS 2020-02-080		8	8.28		8.55	8.83	9.14	9.82		
HLRS 2020-02-080E	○	8	8.28		8.55	8.83	9.14	9.82		
HLRS 2020-02-100		10	10.34		10.68	11.03	11.41	12.26		
HLRS 2020-02-100E	○	10	10.34		10.68	11.03	11.41	12.26		

Unit (mm)

Model Number	Excellent	Outside Diameter ϕD	Corner Radius CR	Effective Length l_1	Length of Cut l	Neck Diameter ϕd_1	Shank Taper Angle Bta	Overall Length L	Shank Diameter ϕd	Suggested Retail Price ¥	
HLRS 2020-02-120		2	RO.2	12	2	1.92	16°	55	4	7,000	
HLRS 2020-02-120E	○			12				55	4	7,700	
HLRS 2020-02-160				16				60	4	7,000	
HLRS 2020-02-200				20				60	4	7,000	
HLRS 2020-02-260				26				70	4	7,000	
HLRS 2020-02-300				30				70	4	7,000	
HLRS 2020-03-040			RO.3	4				50	4	6,650	
HLRS 2020-03-040E	○			4				50	4	7,320	
HLRS 2020-03-060				6				50	4	6,650	
HLRS 2020-03-060E	○			6				50	4	7,320	
HLRS 2020-03-080				8				50	4	7,000	
HLRS 2020-03-080E	○			8				50	4	7,700	
HLRS 2020-03-100				10				50	4	7,000	
HLRS 2020-03-100E	○			10				50	4	7,700	
HLRS 2020-03-120				12				55	4	7,000	
HLRS 2020-03-120E	○			12				55	4	7,700	
HLRS 2020-03-160				16				60	4	7,000	
HLRS 2020-03-200				20				60	4	7,000	
HLRS 2020-03-260				26				70	4	7,000	
HLRS 2020-03-300				30				70	4	7,000	
HLRS 2020-05-040				RO.5				4	50	4	6,650
HLRS 2020-05-040E	○							4	50	4	7,320
HLRS 2020-05-060								6	50	4	6,650
HLRS 2020-05-060E	○							6	50	4	7,320
HLRS 2020-05-080			8					50	4	7,000	
HLRS 2020-05-080E	○		8					50	4	7,700	
HLRS 2020-05-100			10					50	4	7,000	
HLRS 2020-05-100E	○		10					50	4	7,700	
HLRS 2020-05-120			12					55	4	7,000	
HLRS 2020-05-120E	○		12					55	4	7,700	
HLRS 2020-05-160		16	60		4	7,000					
HLRS 2020-05-200		20	60		4	7,000					
HLRS 2020-05-260		26	70	4	7,000						
HLRS 2020-05-300		30	70	4	7,000						
HLRS 2025-01-100		2.5	RO.1	10	2.5	2.42	16°	50	4	7,340	
HLRS 2025-01-200				20				60	4	7,570	
HLRS 2025-01-300				30				70	4	7,800	
HLRS 2025-02-100			RO.2	10				50	4	7,340	
HLRS 2025-02-200				20				60	4	7,570	
HLRS 2025-02-300				30				70	4	7,800	
HLRS 2025-03-100			RO.3	10				50	4	7,340	
HLRS 2025-03-200				20				60	4	7,570	
HLRS 2025-03-300				30				70	4	7,800	
HLRS 2025-05-100			RO.5	10				50	4	7,340	
HLRS 2025-05-200				20				60	4	7,570	
HLRS 2025-05-300				30				70	4	7,800	

- 3mm Shank V Series
- UDC-PCD Series
- CBN Series
- Square
- Long Neck Square
- Radius
- Long Neck Radius
- Taper Neck Radius
- Ball / Long Shank Ball
- Long Neck Ball
- Taper Neck Ball
- Taper
- Barrel
- Spiral V Cutter
- Drill
- Technical Data

Model Number	Excellent	Outside Diameter ϕD	Corner Radius CR	Effective Length l_1	Effective Length by Inclined Angles				
					30°	1°	1°30'	2°	3°
HLRS 2020-02-120		2	RO.2	12	12.40	12.81	13.23	13.69	14.71
HLRS 2020-02-120E	○			12	12.40	12.81	13.23	13.69	14.71
HLRS 2020-02-160				16	16.53	17.06	17.64	18.25	No Interference
HLRS 2020-02-200				20	20.66	21.32	22.04	22.80	No Interference
HLRS 2020-02-260				26	26.84	27.71	28.64	No Interference	No Interference
HLRS 2020-02-300				30	30.97	31.97	33.04	No Interference	No Interference
HLRS 2020-03-040			RO.3	4	4.15	4.28	4.42	4.57	4.91
HLRS 2020-03-040E	○			4	4.15	4.28	4.42	4.57	4.91
HLRS 2020-03-060				6	6.21	6.41	6.63	6.85	7.36
HLRS 2020-03-060E	○			6	6.21	6.41	6.63	6.85	7.36
HLRS 2020-03-080				8	8.28	8.54	8.83	9.13	9.80
HLRS 2020-03-080E	○			8	8.28	8.54	8.83	9.13	9.80
HLRS 2020-03-100				10	10.34	10.67	11.03	11.41	12.25
HLRS 2020-03-100E	○			10	10.34	10.67	11.03	11.41	12.25
HLRS 2020-03-120				12	12.40	12.80	13.23	13.68	14.70
HLRS 2020-03-120E	○			12	12.40	12.80	13.23	13.68	14.70
HLRS 2020-03-160				16	16.53	17.06	17.63	18.24	19.59
HLRS 2020-03-200				20	20.65	21.32	22.03	22.79	No Interference
HLRS 2020-03-260				26	26.84	27.71	28.64	No Interference	No Interference
HLRS 2020-03-300				30	30.97	31.97	33.04	No Interference	No Interference
HLRS 2020-05-040			RO.5	4	4.15	4.28	4.41	4.56	4.89
HLRS 2020-05-040E	○			4	4.15	4.28	4.41	4.56	4.89
HLRS 2020-05-060				6	6.21	6.41	6.62	6.84	7.34
HLRS 2020-05-060E	○			6	6.21	6.41	6.62	6.84	7.34
HLRS 2020-05-080				8	8.27	8.54	8.82	9.12	9.78
HLRS 2020-05-080E	○			8	8.27	8.54	8.82	9.12	9.78
HLRS 2020-05-100				10	10.34	10.67	11.02	11.39	12.23
HLRS 2020-05-100E	○			10	10.34	10.67	11.02	11.39	12.23
HLRS 2020-05-120				12	12.40	12.80	13.22	13.67	14.68
HLRS 2020-05-120E	○			12	12.40	12.80	13.22	13.67	14.68
HLRS 2020-05-160		16		16.53	17.06	17.62	18.23	19.57	
HLRS 2020-05-200		20		20.65	21.31	22.02	22.78	No Interference	
HLRS 2020-05-260		26		26.84	27.70	28.63	No Interference	No Interference	
HLRS 2020-05-300		30		30.97	31.96	33.03	No Interference	No Interference	
HLRS 2025-01-100		2.5	RO.1	10	10.34	10.68	11.04	11.42	12.27
HLRS 2025-01-200				20	20.66	21.33	22.04	No Interference	No Interference
HLRS 2025-01-300				30	30.97	31.98	No Interference	No Interference	No Interference
HLRS 2025-02-100			RO.2	10	10.34	10.68	11.03	11.41	12.26
HLRS 2025-02-200				20	20.66	21.32	22.04	No Interference	No Interference
HLRS 2025-02-300				30	30.97	31.97	No Interference	No Interference	No Interference
HLRS 2025-03-100			RO.3	10	10.34	10.67	11.03	11.41	12.25
HLRS 2025-03-200				20	20.65	21.32	22.03	No Interference	No Interference
HLRS 2025-03-300				30	30.97	31.97	No Interference	No Interference	No Interference
HLRS 2025-05-100			RO.5	10	10.34	10.67	11.02	11.39	12.23
HLRS 2025-05-200				20	20.65	21.31	22.02	No Interference	No Interference
HLRS 2025-05-300				30	30.97	31.96	No Interference	No Interference	No Interference
HLRS 2025-05-300				30	30.97	31.96	No Interference	No Interference	No Interference

3mm Shank
V Series

UDC-PCD
Series

CBN
Series

Square

Square
Long Neck
Square

Radius

Radius
Long Neck
Radius

Radius
Taper Neck
Radius

Ball / Long
Shank Ball

Ball
Long Neck
Ball

Ball
Taper Neck
Ball

Taper

Barrel

Spiral
V Cutter

Drill

Technical Data

Model Number	Excellent	Outside Diameter ϕD	Corner Radius CR	Effective Length l_1	Length of Cut l	Neck Diameter ϕd_1	Shank Taper Angle Bta	Overall Length L	Shank Diameter ϕd	Suggested Retail Price ¥	
HLRS 2030-01-060		3	RO.1	6	3	2.92	16°	55	6	6,000	
HLRS 2030-01-060E	○			6				55	6	6,600	
HLRS 2030-01-120				12				55	6	7,800	
HLRS 2030-01-160				16				60	6	9,100	
HLRS 2030-01-160E	○			16				60	6	10,010	
HLRS 2030-01-180				18				60	6	9,100	
HLRS 2030-01-200				20				60	6	9,100	
HLRS 2030-01-260				26				70	6	9,100	
HLRS 2030-01-300				30				70	6	9,100	
HLRS 2030-01-360				36				80	6	11,200	
HLRS 2030-02-060				RO.2				6	55	6	6,000
HLRS 2030-02-060E	○							6	55	6	6,600
HLRS 2030-02-120			12					55	6	7,800	
HLRS 2030-02-160			16					60	6	9,100	
HLRS 2030-02-160E	○		16					60	6	10,010	
HLRS 2030-02-180			18					60	6	9,100	
HLRS 2030-02-200			20					60	6	9,100	
HLRS 2030-02-260			26					70	6	9,100	
HLRS 2030-02-300			30					70	6	9,100	
HLRS 2030-02-360			36					80	6	11,200	
HLRS 2030-03-060			RO.3					6	55	6	6,000
HLRS 2030-03-060E	○							6	55	6	6,600
HLRS 2030-03-120				12				55	6	7,800	
HLRS 2030-03-160				16				60	6	9,100	
HLRS 2030-03-160E	○			16				60	6	10,010	
HLRS 2030-03-180				18				60	6	9,100	
HLRS 2030-03-200				20				60	6	9,100	
HLRS 2030-03-260				26				70	6	9,100	
HLRS 2030-03-300				30				70	6	9,100	
HLRS 2030-03-360				36				80	6	11,200	
HLRS 2030-05-060				RO.5				6	55	6	6,000
HLRS 2030-05-060E	○							6	55	6	6,600
HLRS 2030-05-120			12					55	6	7,800	
HLRS 2030-05-160			16					60	6	9,100	
HLRS 2030-05-160E	○		16					60	6	10,010	
HLRS 2030-05-180			18					60	6	9,100	
HLRS 2030-05-200		20	60		6	9,100					
HLRS 2030-05-260		26	70		6	9,100					
HLRS 2030-05-300		30	70		6	9,100					
HLRS 2030-05-360		36	80		6	11,200					

- 3mm Shank V Series
- UDC-PCD Series
- CBN Series
- Square
- Long Neck Square
- Radius
- Long Neck Radius
- Taper Neck Radius
- Ball / Long Shank Ball
- Long Neck Ball
- Taper Neck Ball
- Taper
- Barrel
- Spiral V Cutter
- Drill
- Technical Data

Model Number	Excellent	Outside Diameter ϕD	Corner Radius CR	Effective Length l_1	Effective Length by Inclined Angles					
					30°	1°	1°30'	2°	3°	
HLRS 2030-01-060		3	RO.1	6	6.21	6.42	6.63	6.86	7.37	
HLRS 2030-01-060E	○			6	6.21	6.42	6.63	6.86	7.37	
HLRS 2030-01-120				12	12.40	12.81	13.23	13.69	14.72	
HLRS 2030-01-160				16	16.53	17.06	17.64	18.25	19.61	
HLRS 2030-01-160E	○			16	16.53	17.06	17.64	18.25	19.61	
HLRS 2030-01-180				18	18.59	19.19	19.84	20.53	22.06	
HLRS 2030-01-200				20	20.65	21.32	22.04	22.80	24.51	
HLRS 2030-01-260				26	26.84	27.71	28.64	29.64	No Interference	
HLRS 2030-01-300				30	30.97	31.97	33.04	34.19	No Interference	
HLRS 2030-01-360				36	37.16	38.36	39.65	41.02	No Interference	
HLRS 2030-02-060				RO.2	6	6.21	6.41	6.63	6.85	7.36
HLRS 2030-02-060E	○				6	6.21	6.41	6.63	6.85	7.36
HLRS 2030-02-120			12		12.40	12.80	13.23	13.69	14.71	
HLRS 2030-02-160			16		16.53	17.06	17.63	18.24	19.60	
HLRS 2030-02-160E	○		16		16.53	17.06	17.63	18.24	19.60	
HLRS 2030-02-180			18		18.59	19.19	19.83	20.52	22.05	
HLRS 2030-02-200			20		20.65	21.32	22.03	22.80	24.49	
HLRS 2030-02-260			26		26.84	27.71	28.64	29.63	No Interference	
HLRS 2030-02-300			30		30.97	31.97	33.04	34.18	No Interference	
HLRS 2030-02-360			36		37.15	38.36	39.64	41.02	No Interference	
HLRS 2030-03-060			RO.3		6	6.21	6.41	6.62	6.85	7.35
HLRS 2030-03-060E	○				6	6.21	6.41	6.62	6.85	7.35
HLRS 2030-03-120				12	12.40	12.80	13.22	13.68	14.70	
HLRS 2030-03-160				16	16.53	17.06	17.63	18.23	19.59	
HLRS 2030-03-160E	○			16	16.53	17.06	17.63	18.23	19.59	
HLRS 2030-03-180				18	18.59	19.19	19.83	20.51	22.04	
HLRS 2030-03-200				20	20.65	21.32	22.03	22.79	24.48	
HLRS 2030-03-260				26	26.84	27.71	28.63	29.62	No Interference	
HLRS 2030-03-300				30	30.96	31.97	33.03	34.18	No Interference	
HLRS 2030-03-360				36	37.15	38.35	39.64	41.01	No Interference	
HLRS 2030-05-060				RO.5	6	6.21	6.40	6.61	6.83	7.33
HLRS 2030-05-060E	○				6	6.21	6.40	6.61	6.83	7.33
HLRS 2030-05-120			12		12.40	12.79	13.21	13.67	14.67	
HLRS 2030-05-160			16		16.52	17.05	17.62	18.22	19.57	
HLRS 2030-05-160E	○		16		16.52	17.05	17.62	18.22	19.57	
HLRS 2030-05-180			18		18.58	19.18	19.82	20.50	22.02	
HLRS 2030-05-200		20	20.65		21.31	22.02	22.78	24.46		
HLRS 2030-05-260		26	26.84		27.70	28.62	29.61	No Interference		
HLRS 2030-05-300		30	30.96		31.96	33.02	34.16	No Interference		
HLRS 2030-05-360		36	37.15		38.35	39.63	41.00	No Interference		

3mm Shank
V Series

UDC-PCD
Series

CBN
Series

Square

Long Neck
Square

Radius

Long Neck
Radius

Taper Neck
Radius

Ball / Long
Shank Ball

Long Neck
Ball

Taper Neck
Ball

Taper

Barrel

Spiral
V Cutter

Drill

Technical Data

Model Number	Excellent	Outside Diameter ϕD	Corner Radius CR	Effective Length l_1	Length of Cut l	Neck Diameter ϕd_1	Shank Taper Angle Bta	Overall Length L	Shank Diameter ϕd	Suggested Retail Price ¥
HLRS 2030-10-060		3	R1	6	3	2.92	16°	55	6	6,000
HLRS 2030-10-060E	○			6				55	6	6,600
HLRS 2030-10-120				12				55	6	7,800
HLRS 2030-10-160				16				60	6	9,100
HLRS 2030-10-160E	○			16				60	6	10,010
HLRS 2030-10-180				18				60	6	9,100
HLRS 2030-10-200				20				60	6	9,100
HLRS 2030-10-260				26				70	6	9,100
HLRS 2030-10-300				30				70	6	9,100
HLRS 2030-10-360				36				80	6	11,200
HLRS 2040-01-080		4	RO.1	8	4	3.82	16°	65	6	7,800
HLRS 2040-01-080E	○			8				65	6	8,580
HLRS 2040-01-120				12				65	6	8,000
HLRS 2040-01-160				16				65	6	9,400
HLRS 2040-01-200				20				65	6	10,130
HLRS 2040-01-200E	○			20				65	6	11,140
HLRS 2040-01-240				24				70	6	10,130
HLRS 2040-01-320				32				80	6	10,130
HLRS 2040-01-480			48	100				6	16,200	
HLRS 2040-02-080			RO.2	8				65	6	7,800
HLRS 2040-02-080E	○			8				65	6	8,580
HLRS 2040-02-120				12				65	6	8,000
HLRS 2040-02-160				16				65	6	9,400
HLRS 2040-02-200				20				65	6	10,130
HLRS 2040-02-200E	○			20				65	6	11,140
HLRS 2040-02-240				24				70	6	10,130
HLRS 2040-02-320				32				80	6	10,130
HLRS 2040-02-480			48	100				6	16,200	
HLRS 2040-03-080			RO.3	8				65	6	7,800
HLRS 2040-03-080E	○			8				65	6	8,580
HLRS 2040-03-120				12				65	6	8,000
HLRS 2040-03-160				16				65	6	9,400
HLRS 2040-03-200				20				65	6	10,130
HLRS 2040-03-200E	○			20				65	6	11,140
HLRS 2040-03-240				24				70	6	10,130
HLRS 2040-03-320				32				80	6	10,130
HLRS 2040-03-480			48	100				6	16,200	
HLRS 2040-05-080			RO.5	8				65	6	7,800
HLRS 2040-05-080E	○	8		65	6	8,580				
HLRS 2040-05-120		12		65	6	8,000				
HLRS 2040-05-160		16		65	6	9,400				
HLRS 2040-05-200		20		65	6	10,130				
HLRS 2040-05-200E	○	20		65	6	11,140				
HLRS 2040-05-240		24		70	6	10,130				
HLRS 2040-05-320		32		80	6	10,130				
HLRS 2040-05-480		48	100	6	16,200					

- 3mm Shank V Series
- UDC-PCD Series
- CBN Series
- Square
- Long Neck Square
- Radius
- Long Neck Radius
- Taper Neck Radius
- Ball / Long Shank Ball
- Long Neck Ball
- Taper Neck Ball
- Taper
- Barrel
- Spiral V Cutter
- Drill
- Technical Data

Model Number	Excellent	Outside Diameter ϕD	Corner Radius CR	Effective Length l_1	Effective Length by Inclined Angles				
					30°	1°	1°30'	2°	3°
HLRS 2030-10-060		3	R1	6	6.20	6.39	6.59	6.80	7.28
HLRS 2030-10-060E	○			6	6.20	6.39	6.59	6.80	7.28
HLRS 2030-10-120				12	12.39	12.78	13.19	13.63	14.62
HLRS 2030-10-160				16	16.51	17.04	17.59	18.19	19.52
HLRS 2030-10-160E	○			16	16.51	17.04	17.59	18.19	19.52
HLRS 2030-10-180				18	18.58	19.17	19.79	20.47	21.96
HLRS 2030-10-200				20	20.64	21.29	21.99	22.74	24.41
HLRS 2030-10-260				26	26.83	27.68	28.60	29.57	No Interference
HLRS 2030-10-300				30	30.95	31.94	33.00	34.13	No Interference
HLRS 2030-10-360				36	37.14	38.33	39.60	40.96	No Interference
HLRS 2040-01-080				4	RO.1	8	8.45	8.73	9.02
HLRS 2040-01-080E	○	8	8.45			8.73	9.02	9.33	10.03
HLRS 2040-01-120		12	12.58			12.99	13.42	13.89	14.92
HLRS 2040-01-160		16	16.70			17.25	17.82	18.44	No Interference
HLRS 2040-01-200		20	20.83			21.50	22.23	23.00	No Interference
HLRS 2040-01-200E	○	20	20.83			21.50	22.23	23.00	No Interference
HLRS 2040-01-240		24	24.95			25.76	26.63	27.55	No Interference
HLRS 2040-01-320		32	33.21			34.28	35.43	No Interference	No Interference
HLRS 2040-01-480		48	49.71		51.32	No Interference	No Interference	No Interference	
HLRS 2040-02-080		RO.2	8		8.45	8.72	9.01	9.33	10.02
HLRS 2040-02-080E	○		8		8.45	8.72	9.01	9.33	10.02
HLRS 2040-02-120			12		12.58	12.98	13.42	13.88	14.91
HLRS 2040-02-160			16		16.70	17.24	17.82	18.44	No Interference
HLRS 2040-02-200			20		20.83	21.50	22.22	22.99	No Interference
HLRS 2040-02-200E	○		20		20.83	21.50	22.22	22.99	No Interference
HLRS 2040-02-240			24		24.95	25.76	26.62	27.54	No Interference
HLRS 2040-02-320			32		33.20	34.28	35.43	No Interference	No Interference
HLRS 2040-02-480		48	49.71		51.32	No Interference	No Interference	No Interference	
HLRS 2040-03-080		RO.3	8		8.45	8.72	9.01	9.32	10.01
HLRS 2040-03-080E	○		8		8.45	8.72	9.01	9.32	10.01
HLRS 2040-03-120			12		12.58	12.98	13.41	13.87	14.69
HLRS 2040-03-160			16		16.70	17.24	17.81	18.43	No Interference
HLRS 2040-03-200			20		20.83	21.50	22.22	22.98	No Interference
HLRS 2040-03-200E	○		20		20.83	21.50	22.22	22.98	No Interference
HLRS 2040-03-240			24		24.95	25.76	26.62	27.54	No Interference
HLRS 2040-03-320			32		33.20	34.28	35.42	No Interference	No Interference
HLRS 2040-03-480			48		49.71	51.31	No Interference	No Interference	No Interference
HLRS 2040-05-080			RO.5		8	8.45	8.71	9.00	9.31
HLRS 2040-05-080E	○	8		8.45	8.71	9.00	9.31	9.99	
HLRS 2040-05-120		12		12.57	12.97	13.40	13.86	14.88	
HLRS 2040-05-160		16		16.70	17.23	17.80	18.42	No Interference	
HLRS 2040-05-200		20		20.82	21.49	22.21	22.97	No Interference	
HLRS 2040-05-200E	○	20		20.82	21.49	22.21	22.97	No Interference	
HLRS 2040-05-240		24		24.95	25.75	26.61	27.52	No Interference	
HLRS 2040-05-320		32		33.20	34.27	35.41	No Interference	No Interference	
HLRS 2040-05-480		48	49.70	51.31	No Interference	No Interference	No Interference		

3mm Shank
V Series

UDC-PCD
Series

CBN
Series

Square
Square
Long Neck
Square

Radius
Radius
Long Neck
Radius
Taper Neck
Radius

Ball / Long
Shank Ball
Long Neck
Ball

Ball
Ball
Taper Neck
Ball

Taper
Taper

Barrel

Spiral
V Cutter

Drill

Technical Data

Model Number	Excellent	Outside Diameter ϕD	Corner Radius CR	Effective Length l_1	Length of Cut l	Neck Diameter ϕd_1	Shank Taper Angle Bta	Overall Length L	Shank Diameter ϕd	Suggested Retail Price ¥				
HLRS 2040-10-080		4	R1	8	4	3.82	16°	65	6	7,800				
HLRS 2040-10-080E	○			8				8,580						
HLRS 2040-10-120				12				8,000						
HLRS 2040-10-160				16				9,400						
HLRS 2040-10-200				20				10,130						
HLRS 2040-10-200E	○			20				11,140						
HLRS 2040-10-240				24				10,130						
HLRS 2040-10-320				32				10,130						
HLRS 2040-10-480				48				16,200						
HLRS 2050-02-200				5				RO.2	20	5	4.82	16°	70	6
HLRS 2050-02-400		40	16,200											
HLRS 2050-03-200		RO.3	20		70	6	12,900							
HLRS 2050-03-400			40		90	6	16,200							
HLRS 2050-05-200		RO.5	20		70	6	12,900							
HLRS 2050-05-400			40		90	6	16,200							
HLRS 2050-10-200		R1	20		70	6	12,900							
HLRS 2050-10-400			40		90	6	16,200							
HLRS 2060-01-120		6	RO.1		12	6	5.82	-	65				6	12,900
HLRS 2060-01-120E	○				12				65				6	14,190
HLRS 2060-01-200				20	70				6	12,900				
HLRS 2060-01-300				30	100				6	16,700				
HLRS 2060-01-300E	○			30	100				6	18,370				
HLRS 2060-01-600				60	120				6	20,300				
HLRS 2060-02-120			RO.2	12	65				6	12,900				
HLRS 2060-02-120E	○			12	65				6	14,190				
HLRS 2060-02-200				20	70				6	12,900				
HLRS 2060-02-300				30	100				6	16,700				
HLRS 2060-02-300E	○		30	100	6				18,370					
HLRS 2060-02-600			60	120	6				20,300					
HLRS 2060-03-120			RO.3	12	65				6	12,900				
HLRS 2060-03-120E	○			12	65				6	14,190				
HLRS 2060-03-200				20	70				6	12,900				
HLRS 2060-03-300				30	100				6	16,700				
HLRS 2060-03-300E	○			30	100				6	18,370				
HLRS 2060-03-600				60	120				6	20,300				
HLRS 2060-05-120			RO.5	12	65				6	12,900				
HLRS 2060-05-120E	○			12	65				6	14,190				
HLRS 2060-05-200		20		70	6	12,900								
HLRS 2060-05-300		30		100	6	16,700								
HLRS 2060-05-300E	○	30		100	6	18,370								
HLRS 2060-05-600		60		120	6	20,300								
HLRS 2060-10-120		R1	12	65	6	12,900								
HLRS 2060-10-120E	○		12	65	6	14,190								
HLRS 2060-10-200			20	70	6	12,900								
HLRS 2060-10-300			30	100	6	16,700								
HLRS 2060-10-300E	○		30	100	6	18,370								
HLRS 2060-10-600			60	120	6	20,300								

- 3mm Shank V Series
- UDC-PCD Series
- CBN Series
- Square
- Long Neck Square
- Radius
- Long Neck Radius
- Taper Neck Radius
- Ball / Long Shank Ball
- Long Neck Ball
- Taper Neck Ball
- Taper
- Barrel
- Spiral V Cutter
- Drill
- Technical Data

Model Number	Excellent	Outside Diameter ϕD	Corner Radius CR	Effective Length l_1	Effective Length by Inclined Angles					
					30°	1°	1'30"	2°	3°	
HLRS 2040-10-080		4	R1	8	8.44	8.70	8.98	9.27	9.93	
HLRS 2040-10-080E	○			8	8.44	8.70	8.98	9.27	9.93	
HLRS 2040-10-120				12	12.56	12.96	13.38	13.83	14.83	
HLRS 2040-10-160				16	16.69	17.22	17.78	18.38	19.72	
HLRS 2040-10-200				20	20.82	21.48	22.18	22.94	No Interference	
HLRS 2040-10-200E	○			20	20.82	21.48	22.18	22.94	No Interference	
HLRS 2040-10-240				24	24.94	25.74	26.58	27.49	No Interference	
HLRS 2040-10-320				32	33.19	34.25	35.39	No Interference	No Interference	
HLRS 2040-10-480				48	49.69	51.29	No Interference	No Interference	No Interference	
HLRS 2050-02-200				5	R0.2	20	20.83	21.50	No Interference	No Interference
HLRS 2050-02-400		40	41.46			No Interference	No Interference	No Interference	No Interference	
HLRS 2050-03-200		R0.3	20		20.83	21.50	No Interference	No Interference	No Interference	
HLRS 2050-03-400			40		41.45	No Interference	No Interference	No Interference	No Interference	
HLRS 2050-05-200		R0.5	20		20.82	21.49	No Interference	No Interference	No Interference	
HLRS 2050-05-400			40		41.45	No Interference	No Interference	No Interference	No Interference	
HLRS 2050-10-200		R1	20		20.82	21.48	No Interference	No Interference	No Interference	
HLRS 2050-10-400			40		41.44	No Interference	No Interference	No Interference	No Interference	
HLRS 2060-01-120		6	R0.1		12	No Interference	No Interference	No Interference	No Interference	No Interference
HLRS 2060-01-120E	○				12	No Interference	No Interference	No Interference	No Interference	No Interference
HLRS 2060-01-200				20	No Interference	No Interference	No Interference	No Interference	No Interference	
HLRS 2060-01-300				30	No Interference	No Interference	No Interference	No Interference	No Interference	
HLRS 2060-01-300E	○			30	No Interference	No Interference	No Interference	No Interference	No Interference	
HLRS 2060-01-600				60	No Interference	No Interference	No Interference	No Interference	No Interference	
HLRS 2060-02-120			R0.2	12	No Interference	No Interference	No Interference	No Interference	No Interference	
HLRS 2060-02-120E	○			12	No Interference	No Interference	No Interference	No Interference	No Interference	
HLRS 2060-02-200				20	No Interference	No Interference	No Interference	No Interference	No Interference	
HLRS 2060-02-300				30	No Interference	No Interference	No Interference	No Interference	No Interference	
HLRS 2060-02-300E	○			30	No Interference	No Interference	No Interference	No Interference	No Interference	
HLRS 2060-02-600				60	No Interference	No Interference	No Interference	No Interference	No Interference	
HLRS 2060-03-120			R0.3	12	No Interference	No Interference	No Interference	No Interference	No Interference	
HLRS 2060-03-120E	○			12	No Interference	No Interference	No Interference	No Interference	No Interference	
HLRS 2060-03-200				20	No Interference	No Interference	No Interference	No Interference	No Interference	
HLRS 2060-03-300				30	No Interference	No Interference	No Interference	No Interference	No Interference	
HLRS 2060-03-300E	○			30	No Interference	No Interference	No Interference	No Interference	No Interference	
HLRS 2060-03-600				60	No Interference	No Interference	No Interference	No Interference	No Interference	
HLRS 2060-05-120			R0.5	12	No Interference	No Interference	No Interference	No Interference	No Interference	
HLRS 2060-05-120E	○			12	No Interference	No Interference	No Interference	No Interference	No Interference	
HLRS 2060-05-200				20	No Interference	No Interference	No Interference	No Interference	No Interference	
HLRS 2060-05-300				30	No Interference	No Interference	No Interference	No Interference	No Interference	
HLRS 2060-05-300E	○			30	No Interference	No Interference	No Interference	No Interference	No Interference	
HLRS 2060-05-600				60	No Interference	No Interference	No Interference	No Interference	No Interference	
HLRS 2060-10-120			R1	12	No Interference	No Interference	No Interference	No Interference	No Interference	
HLRS 2060-10-120E	○			12	No Interference	No Interference	No Interference	No Interference	No Interference	
HLRS 2060-10-200				20	No Interference	No Interference	No Interference	No Interference	No Interference	
HLRS 2060-10-300				30	No Interference	No Interference	No Interference	No Interference	No Interference	
HLRS 2060-10-300E	○			30	No Interference	No Interference	No Interference	No Interference	No Interference	
HLRS 2060-10-600				60	No Interference	No Interference	No Interference	No Interference	No Interference	

- 3mm Shank V Series
- UDC-PCD Series
- CBN Series
- Square
- Square Long Neck Square
- Radius
- Radius Long Neck Radius
- Radius Taper Neck Radius
- Ball / Long Shank Ball
- Ball Long Neck Ball
- Ball Taper Neck Ball
- Taper
- Barrel
- Spiral V Cutter
- Drill
- Technical Data

Milling Conditions for HLRS (2 Flutes)

WORK MATERIAL			Copper OFC / TPC				PREHARDENED STEELS HARDENED STEELS NAK / SKD (30~45HRC)				HARDENED STEELS SKD / SKT (45~55HRC)				HARDENED STEELS SKD / SKH (55~65HRC)			
Model Number	Outside Diameter (mm)	Effective Length (mm)	Spindle Speed (min ⁻¹)	Feed Rate (mm/min)	a _p Axial Depth (mm)	a _e Radial Depth (mm)	Spindle Speed (min ⁻¹)	Feed Rate (mm/min)	a _p Axial Depth (mm)	a _e Radial Depth (mm)	Spindle Speed (min ⁻¹)	Feed Rate (mm/min)	a _p Axial Depth (mm)	a _e Radial Depth (mm)	Spindle Speed (min ⁻¹)	Feed Rate (mm/min)	a _p Axial Depth (mm)	a _e Radial Depth (mm)
2002	0.2	0.5	55,000	230	0.027	0.02	55,000	230	0.006	0.02	44,800	236	0.005	0.02	19,000	30	0.002	0.015
		1	55,000	200	0.027	0.02	55,000	200	0.006	0.02	35,000	150	0.004	0.02	15,000	25	0.0015	0.015
		1.5	55,000	180	0.017	0.01	55,000	180	0.005	0.01	27,000	100	0.003	0.01	12,000	20	0.001	0.007
		2	55,000	170	0.007	0.005	55,000	170	0.003	0.005	20,000	60	0.002	0.005	10,500	15	0.001	0.003
2003	0.3	1	60,000	500	0.03	0.02	60,000	500	0.007	0.02	35,000	350	0.005	0.02	22,000	35	0.004	0.015
		1.5	60,000	470	0.03	0.02	60,000	470	0.007	0.02	35,000	310	0.005	0.018	22,000	33	0.004	0.015
		2	60,000	400	0.03	0.02	60,000	400	0.007	0.02	33,200	250	0.005	0.015	20,000	32	0.004	0.015
		2.5	57,000	330	0.03	0.017	57,000	330	0.007	0.017	30,000	180	0.003	0.012	18,000	30	0.002	0.012
		3	52,000	220	0.03	0.015	52,000	220	0.006	0.015	25,000	80	0.003	0.01	15,000	20	0.002	0.01
2004	0.4	1	50,900	610	0.048	0.063	50,900	510	0.013	0.072	40,700	370	0.011	0.072	24,200	40	0.004	0.072
		1.5	45,200	580	0.045	0.063	45,200	480	0.012	0.054	36,200	360	0.01	0.054	21,500	38	0.004	0.054
		2	40,400	540	0.042	0.054	40,400	450	0.011	0.045	32,300	330	0.009	0.045	19,200	35	0.004	0.045
		3	33,900	460	0.027	0.054	33,900	390	0.008	0.027	27,100	280	0.007	0.027	16,100	30	0.003	0.027
		4	30,000	220	0.01	0.045	30,000	340	0.006	0.014	24,000	250	0.005	0.014	14,300	27	0.002	0.014
2005	0.5	1	49,200	1,370	0.081	0.117	49,200	1,140	0.034	0.122	40,000	860	0.03	0.122	24,800	94	0.013	0.122
		2	39,900	1,000	0.075	0.108	39,900	830	0.029	0.117	32,500	630	0.026	0.117	20,100	68	0.011	0.117
		3	31,900	770	0.057	0.09	31,900	640	0.023	0.113	26,000	480	0.02	0.113	16,100	52	0.008	0.113
		4	29,100	660	0.039	0.072	29,100	550	0.016	0.108	23,700	410	0.014	0.108	14,600	45	0.006	0.108
		5	26,400	570	0.027	0.045	26,400	470	0.011	0.099	21,500	360	0.01	0.099	13,300	39	0.004	0.099
		6	24,200	480	0.021	0.018	24,200	400	0.007	0.09	19,700	300	0.006	0.09	12,200	33	0.003	0.09
2006	0.6	2	28,600	610	0.114	0.162	28,600	510	0.01	0.219	23,700	390	0.01	0.219	15,200	43	0.004	0.219
		3	23,800	480	0.09	0.135	23,800	400	0.008	0.108	19,700	300	0.007	0.108	12,600	33	0.003	0.108
		4	20,400	400	0.063	0.108	20,400	330	0.005	0.104	16,800	250	0.005	0.104	10,800	28	0.002	0.104
		6	16,800	300	0.036	0.045	16,800	250	0.003	0.099	13,900	190	0.003	0.099	8,900	21	0.001	0.099
		8	14,600	240	0.021	0.027	14,600	200	0.002	0.072	12,100	150	0.002	0.072	7,700	16	0.001	0.072
2007	0.7	4	18,400	480	0.087	0.162	18,400	400	0.008	0.117	15,500	310	0.008	0.117	10,200	35	0.004	0.117
		6	15,400	360	0.051	0.108	15,400	300	0.005	0.108	13,000	230	0.005	0.108	8,600	26	0.002	0.108
2008	0.8	4	17,500	540	0.132	0.198	17,500	450	0.014	0.117	15,000	360	0.015	0.117	10,200	41	0.007	0.117
		6	14,600	410	0.075	0.144	14,600	340	0.008	0.108	12,500	270	0.008	0.108	8,500	30	0.004	0.108
		8	12,800	310	0.03	0.1	12,800	270	0.005	0.09	11,000	185	0.004	0.09	7,600	20	0.002	0.09
2010	1	2	17,600	1,100	0.21	0.45	17,600	920	0.035	0.27	15,300	750	0.04	0.27	10,900	89	0.02	0.27
		3	15,500	1,050	0.205	0.425	15,500	870	0.031	0.27	13,200	720	0.037	0.27	9,400	86	0.018	0.27
		4	13,800	980	0.201	0.405	13,800	820	0.03	0.27	12,000	670	0.035	0.27	8,500	80	0.017	0.27
		5	12,500	900	0.16	0.4	12,500	720	0.025	0.24	11,000	600	0.03	0.24	7,800	72	0.015	0.24
		6	11,300	790	0.117	0.387	11,300	650	0.021	0.216	9,800	540	0.024	0.216	7,000	64	0.012	0.216
		8	9,800	590	0.072	0.36	9,800	490	0.016	0.189	8,500	400	0.018	0.189	6,100	48	0.009	0.189
		10	8,800	390	0.048	0.315	8,800	320	0.011	0.126	7,600	270	0.013	0.126	5,400	32	0.006	0.126
		12	8,100	260	0.033	0.27	8,100	210	0.008	0.072	7,000	180	0.009	0.072	5,000	21	0.004	0.072
		16	7,000	230	0.018	0.225	7,000	190	0.004	0.027	6,100	160	0.005	0.027	4,300	19	0.002	0.027
		20	6,300	160	0.015	0.18	6,300	130	0.003	0.018	5,500	110	0.003	0.018	3,900	13	0.001	0.018

Milling Conditions for HLRS (2 Flutes)

WORK MATERIAL			Copper OFC / TPC				PREHARDENED STEELS HARDENED STEELS NAK / SKD (30~45HRC)				HARDENED STEELS SKD / SKT (45~55HRC)				HARDENED STEELS SKD / SKH (55~65HRC)			
Model Number	Outside Diameter (mm)	Effective Length (mm)	Spindle Speed (min ⁻¹)	Feed Rate (mm/min)	a _p Axial Depth (mm)	a _e Radial Depth (mm)	Spindle Speed (min ⁻¹)	Feed Rate (mm/min)	a _p Axial Depth (mm)	a _e Radial Depth (mm)	Spindle Speed (min ⁻¹)	Feed Rate (mm/min)	a _p Axial Depth (mm)	a _e Radial Depth (mm)	Spindle Speed (min ⁻¹)	Feed Rate (mm/min)	a _p Axial Depth (mm)	a _e Radial Depth (mm)
2012	1.2	6	9,400	700	0.186	0.468	9,400	580	0.018	0.09	8,400	490	0.022	0.09	6,200	60	0.011	0.09
		12	6,800	440	0.054	0.405	6,800	370	0.007	0.072	6,100	310	0.008	0.072	4,500	38	0.004	0.072
		20	5,400	250	0.021	0.24	5,400	210	0.003	0.018	4,800	180	0.003	0.018	3,500	22	0.002	0.018
2015	1.5	4	13,200	1,310	0.3	0.675	13,200	1,090	0.045	0.45	12,000	950	0.06	0.45	9,200	124	0.033	0.45
		6	10,600	1,240	0.282	0.63	10,600	1,030	0.041	0.405	9,700	900	0.055	0.405	7,400	117	0.03	0.405
		8	9,300	1,050	0.204	0.612	9,300	870	0.034	0.315	8,500	760	0.045	0.315	6,500	99	0.025	0.315
		10	8,500	900	0.15	0.567	8,500	750	0.032	0.288	7,800	650	0.042	0.288	6,000	85	0.023	0.288
		12	7,800	800	0.114	0.54	7,800	670	0.029	0.27	7,100	580	0.038	0.27	5,400	76	0.021	0.27
		16	6,800	620	0.066	0.45	6,800	510	0.015	0.18	6,200	450	0.02	0.18	4,700	58	0.011	0.18
		20	6,000	490	0.042	0.36	6,000	410	0.005	0.108	5,500	360	0.006	0.108	4,200	46	0.003	0.108
2020	2	4	15,300	1,500	0.33	0.9	15,300	1,250	0.046	0.9	14,300	1,130	0.065	0.9	11,500	162	0.039	0.9
		6	12,800	1,220	0.321	0.855	12,800	1,020	0.043	0.81	12,000	930	0.06	0.81	9,700	133	0.036	0.81
		8	11,200	1,120	0.267	0.81	11,200	930	0.039	0.72	10,400	850	0.055	0.72	8,400	121	0.033	0.72
		10	10,000	1,050	0.225	0.765	10,000	870	0.033	0.585	9,300	790	0.047	0.585	7,600	113	0.028	0.585
		12	9,100	980	0.186	0.72	9,100	820	0.031	0.45	8,500	740	0.044	0.45	6,900	107	0.026	0.45
		16	7,800	830	0.132	0.702	7,800	690	0.028	0.315	7,300	630	0.039	0.315	5,900	90	0.023	0.315
		20	7,000	770	0.093	0.666	7,000	640	0.017	0.198	6,600	580	0.024	0.198	5,300	84	0.014	0.198
		26	6,200	700	0.06	0.54	6,200	580	0.006	0.144	5,800	530	0.008	0.144	4,600	75	0.005	0.144
		30	6,000	670	0.05	0.45	6,000	550	0.005	0.135	5,500	500	0.005	0.135	4,400	70	0.002	0.135
2025	2.5	10	10,500	1,220	0.339	0.855	10,500	1,020	0.052	0.54	10,000	960	0.075	0.54	8,400	154	0.048	0.54
		20	7,800	720	0.165	0.756	7,800	600	0.024	0.225	7,500	560	0.035	0.225	6,300	91	0.022	0.225
		30	6,300	540	0.069	0.63	6,300	450	0.011	0.18	6,000	420	0.016	0.18	5,000	67	0.01	0.18
2030	3	6	14,000	2,700	0.5	0.9	14,000	1,510	0.15	0.72	13,300	1,140	0.15	0.72	12,000	270	0.1	0.72
		12	10,500	1,600	0.39	0.85	10,500	1,150	0.105	0.67	10,000	890	0.105	0.67	9,000	200	0.075	0.67
		16	9,200	1,160	0.321	0.81	9,200	960	0.081	0.63	8,800	730	0.081	0.63	7,900	173	0.054	0.63
		18	8,800	1,100	0.29	0.79	8,800	900	0.078	0.6	8,300	700	0.078	0.6	7,500	160	0.048	0.6
		20	8,400	1,050	0.26	0.78	8,400	880	0.073	0.58	7,900	680	0.073	0.58	7,100	150	0.044	0.58
		26	7,500	980	0.18	0.72	7,500	820	0.065	0.495	7,100	620	0.065	0.495	6,400	146	0.043	0.495
		30	7,000	870	0.14	0.69	7,000	720	0.05	0.38	6,500	560	0.05	0.38	6,000	118	0.029	0.38
		36	6,400	710	0.09	0.63	6,400	590	0.022	0.18	6,100	440	0.022	0.18	5,500	105	0.014	0.18
2040	4	8	10,200	1,340	0.42	1.62	10,200	1,110	0.095	1.35	8,500	970	0.14	1.35	7,300	223	0.101	1.35
		12	8,900	1,300	0.41	1.56	8,900	1,080	0.083	1.15	7,600	950	0.12	1.15	6,400	215	0.085	1.15
		16	7,900	1,250	0.4	1.5	7,900	1,030	0.065	1	6,600	910	0.1	1	5,600	205	0.065	1
		20	6,900	1,190	0.384	1.44	6,900	990	0.054	0.9	5,800	860	0.08	0.9	4,900	198	0.058	0.9
		24	6,200	1,100	0.31	1.38	6,200	900	0.043	0.8	5,200	770	0.065	0.8	4,500	175	0.043	0.8
		32	5,500	860	0.189	1.26	5,500	720	0.027	0.648	4,600	630	0.04	0.648	3,900	144	0.029	0.648
		48	4,600	430	0.093	1.08	4,600	360	0.007	0.315	3,900	310	0.01	0.315	3,300	72	0.007	0.315

Ø3mm Shank
V SeriesUDC-PCD
SeriesCBN
SeriesSquare
Long Neck
SquareRadius
Long Neck
Radius
Taper Neck
RadiusBall / Long
Shank BallBall
Long Neck
Ball
Taper Neck
BallTaper
Taper

Barrel

Spiral
V Cutter

Drill

Technical Data

Milling Conditions for HLRS (2 Flutes)

WORK MATERIAL			Copper OFC / TPC				PREHARDENED STEELS HARDENED STEELS NAK / SKD (30~45HRC)				HARDENED STEELS SKD / SKT (45~55HRC)				HARDENED STEELS SKD / SKH (55~65HRC)			
Model Number	Outside Diameter (mm)	Effective Length (mm)	Spindle Speed (min ⁻¹)	Feed Rate (mm/min)	a_p Axial Depth (mm)	a_e Radial Depth (mm)	Spindle Speed (min ⁻¹)	Feed Rate (mm/min)	a_p Axial Depth (mm)	a_e Radial Depth (mm)	Spindle Speed (min ⁻¹)	Feed Rate (mm/min)	a_p Axial Depth (mm)	a_e Radial Depth (mm)	Spindle Speed (min ⁻¹)	Feed Rate (mm/min)	a_p Axial Depth (mm)	a_e Radial Depth (mm)
2050	5	20	6,700	1,780	0.606	1.98	6,700	1,480	0.092	1.17	4,800	990	0.13	1.17	4,000	297	0.096	1.17
		40	4,600	850	0.297	1.53	4,600	710	0.046	0.9	3,300	470	0.065	0.9	2,800	143	0.048	0.9
2060	6	12	8,000	1,800	0.6	2.25	8,000	1,620	0.5	1.35	4,700	1,360	0.2	1.35	4,000	540	0.15	1.35
		20	5,800	1,350	0.58	2.12	5,800	1,180	0.46	1.31	3,500	1,000	0.18	1.31	3,000	380	0.14	1.31
		30	4,500	1,060	0.546	1.98	4,500	880	0.396	1.26	2,600	740	0.158	1.26	2,200	294	0.119	1.26
		60	2,800	530	0.156	1.62	2,800	440	0.113	0.99	1,600	370	0.045	0.99	1,400	147	0.034	0.99

Side Milling

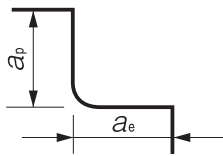

Note:

- Decrease both spindle speed and feed rate proportionally when the milling parameters exceed the machine's maximum spindle speed.
- Every coolant offers stable milling.
- Recommend oil coolant for Stainless Steels and Heat Resistant Alloys.
- Recommend wet coolant for Copper.

Ø3mm Shank V Series

UDC-PCD Series

CBN Series

Square
Long Neck Square

Radius

Long Neck Radius
Taper Neck Radius

Ball / Long Shank Ball

Long Neck Ball
Taper Neck Ball

Taper

Barrel

Spiral V Cutter

Drill

Technical Data

∅3mm Shank
V Series

UDC-PCD
Series

CBN
Series

Square

Square

Long Neck
Square

Radius

Radius

Long Neck
Radius

Taper Neck
Radius

Ball

Ball / Long
Shank Ball

Long Neck
Ball

Taper Neck
Ball

Taper

Taper

Barrel

Spiral
V Cutter

Drill

Technical Data



Size $\phi 0.2 \sim \phi 6$

HGLRS

Super MG

HMGC
COAT

30°

R

± 0.003

Shank Dia
0/-0.004

Back Taper
Geometry

Variable
Pitch

NEW

Material Applications (★ Highly Recommended ● Recommended ○ Suggested)

Work Material																	
Carbon Steels S45C S55C	Alloy Steels SK / SCM SUS	Prehardened Steels NAK HPM	Hardened Steels					Cast Iron	Aluminum Alloys	Graphite	Copper	Plastics	Glass Filled Plastics	Titanium Alloys	Heat Resistant Alloys	Cemented Carbide	Hard Brittle (Non-Metallic) Materials
			~50HRC	~55HRC	~60HRC	~65HRC	~70HRC										
		○	●	●	●	★	★										

φ3mm Shank V Series

UDC-PCD Series

CBN Series

Square

Long Neck Square

Radius

Long Neck Radius

Taper Neck Radius

Ball / Long Shank Ball

Long Neck Ball

Taper Neck Ball

Taper

Barrel

Spiral V Cutter

Drill

Technical Data

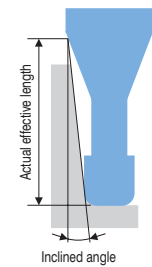
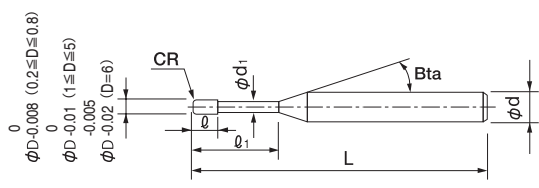

The shank taper angle shown is not an exact value and to avoid contact with the work piece, we recommend the user controls the precise value of this angle. Shank taper angle should not make contact with the work piece.

◆ **Super negative rake angle is best suited for 60-70 HRC as it greatly reduces the cutting resistance.**

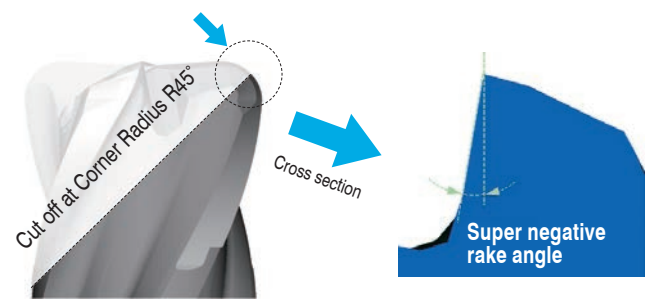
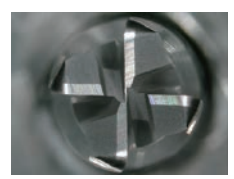

◆ **High Precision Diameter Tolerance / Radius Accuracy / Shank Diameter Tolerance**

HLRS Tolerance				Unit (mm)
Outside Diameter	Diameter Tolerance	Radius Accuracy	Shank Diameter Tolerance	
$0.2 \leq D \leq 0.6$	0/-0.01	±0.005	0/-0.005	
$0.8 \leq D \leq 5$	0/-0.015			
D=6	-0.005/-0.02			

HGLRS Tolerance				Unit (mm)
Outside Diameter	Diameter Tolerance	Radius Accuracy	Shank Diameter Tolerance	
$0.2 \leq D \leq 0.8$	0/-0.008	±0.003	0/-0.004 (h4)	
$1 \leq D \leq 5$	0/-0.01			
D=6	-0.005/-0.02			

Dimensional accuracy comparison HGLRS $\phi 3 \times \text{CR0.3} \times \text{EL16}$

HAP72 (69HRC)

Smaller dimensional change and better milling accuracy with HGLRS

Spindle Speed (min ⁻¹)	Feed Rate (mm/min)	a_p (mm)	a_e (mm)	Cycle Time	Coolant
7,000	1,800	0.03	0.02	15 min	Air Blow

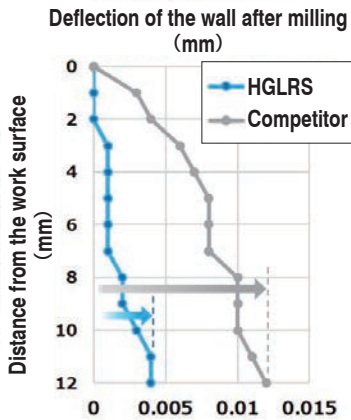

Surface condition after milling

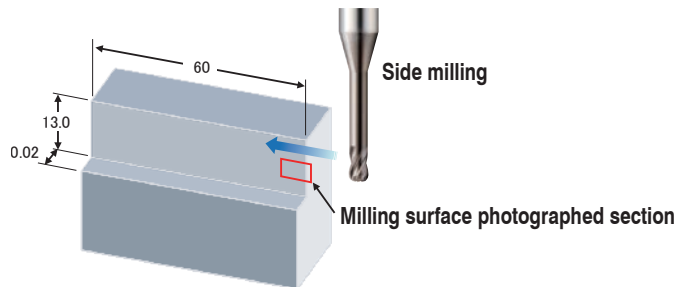
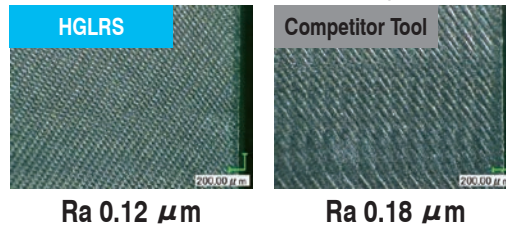

Wear width comparison HGLRS $\phi 3 \times \text{CR0.3} \times \text{EL16}$

HAP72 (69HRC)

High efficiency milling and long tool life achieved even on new generation super hard materials.

Spindle Speed (min ⁻¹)	Feed Rate (mm/min)	a_p (mm)	a_e (mm)	Cycle Time	Coolant
7,000	900	0.03	0.6	68 min	Air Blow

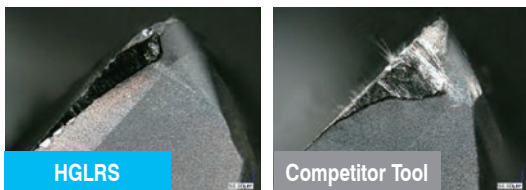

Milling shape
Square pocket $10 \times 10 \times 5 \text{ mm}$

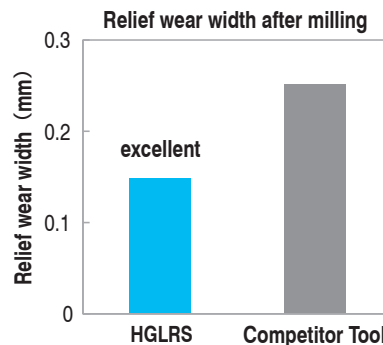

4 Flutes

$\phi 3\text{mm}$ Shank
V Series

UDC-PCD
Series

CBN
Series

Square

Long Neck
Square

Radius

Long Neck
Radius

Radius

Taper Neck
Radius

Ball

Ball / Long
Shank Ball

Ball

Long Neck
Ball

Taper

Taper

Barrel

Barrel

Spiral
V Cutter

Spiral
V Cutter

Drill

Drill

Technical Data

Technical Data

Total 184 models

Unit (mm)

Model Number	Outside Diameter ϕD	Corner Radius CR	Effective Length ℓ_1	Length of Cut ℓ	Neck Diameter ϕd_1	Shank Taper Angle β_{ta}	Overall Length L	Shank Diameter ϕd	Suggested Retail Price ¥
HGLRS 4002-002-005	0.2	RO.02	0.5	0.12	0.185	16°	50	4	14,100
HGLRS 4002-002-010			1				50	4	14,100
HGLRS 4002-002-020			2				50	4	14,100
HGLRS 4002-005-005		RO.05	0.5				50	4	14,100
HGLRS 4002-005-010			1				50	4	14,100
HGLRS 4002-005-020			2				50	4	14,100
HGLRS 4003-002-005	0.3	RO.02	0.5	0.18	0.285	16°	50	4	14,100
HGLRS 4003-002-010			1				50	4	14,100
HGLRS 4003-002-015			1.5				50	4	14,100
HGLRS 4003-002-020		2	50				4	14,100	
HGLRS 4003-005-005		RO.05	0.5				50	4	14,100
HGLRS 4003-005-010			1				50	4	14,100
HGLRS 4003-005-020	2		50	4	14,100				
HGLRS 4004-002-010	0.4	RO.02	1	0.24	0.385	16°	50	4	9,050
HGLRS 4004-002-020			2				50	4	9,050
HGLRS 4004-005-010		RO.05	1				50	4	9,050
HGLRS 4004-005-020			2				50	4	9,050
HGLRS 4004-01-010		RO.1	1				50	4	9,050
HGLRS 4004-01-020			2				50	4	9,050
HGLRS 4005-002-010	0.5	RO.02	1	0.3	0.485	16°	50	4	7,370
HGLRS 4005-002-020			2				50	4	7,370
HGLRS 4005-002-030			3				50	4	7,370
HGLRS 4005-005-010		RO.05	1				50	4	7,370
HGLRS 4005-005-020			2				50	4	7,370
HGLRS 4005-005-030			3				50	4	7,370
HGLRS 4005-01-010	RO.1	1	50	4	7,370				
HGLRS 4005-01-020		2	50	4	7,370				
HGLRS 4005-01-030		3	50	4	7,370				
HGLRS 4006-005-020	0.6	RO.05	2	0.36	0.585	16°	50	4	7,370
HGLRS 4006-005-040			4				50	4	7,370
HGLRS 4006-01-020		RO.1	2				50	4	7,370
HGLRS 4006-01-040			4				50	4	7,370
HGLRS 4008-005-020	0.8	RO.05	2	0.48	0.78	16°	50	4	8,100
HGLRS 4008-005-040			4				50	4	8,400
HGLRS 4008-005-060			6				50	4	8,400
HGLRS 4008-01-020		RO.1	2				50	4	8,100
HGLRS 4008-01-040			4				50	4	8,400
HGLRS 4008-01-060			6				50	4	8,400
HGLRS 4008-02-020	RO.2	2	50	4	8,100				
HGLRS 4008-02-040		4	50	4	8,400				
HGLRS 4008-02-060		6	50	4	8,400				
HGLRS 4010-002-020		1	RO.02	2	0.8	0.98	16°	50	4
HGLRS 4010-002-030	3			50				4	7,400
HGLRS 4010-002-040	4			50				4	7,400
HGLRS 4010-002-050	5			50				4	8,100

- $\phi 3\text{mm}$ Shank V Series
- UDC-PCD Series
- CBN Series
- Square
- Long Neck Square
- Radius
- Long Neck Radius
- Taper Neck Radius
- Ball / Long Shank Ball
- Long Neck Ball
- Taper Neck Ball
- Taper
- Barrel
- Spiral V Cutter
- Drill
- Technical Data

Model Number	Outside Diameter ϕD	Corner Radius CR	Effective Length l_1	Effective Length by Inclined Angles				
				30°	1°	1°30'	2°	3°
HGLRS 4002-002-005	0.2	RO.02	0.5	0.61	0.64	0.67	0.70	0.76
HGLRS 4002-002-010			1	1.13	1.18	1.23	1.28	1.38
HGLRS 4002-002-020			2	2.17	2.25	2.34	2.43	2.63
HGLRS 4002-005-005		RO.05	0.5	0.60	0.64	0.67	0.70	0.75
HGLRS 4002-005-010			1	1.13	1.18	1.22	1.27	1.37
HGLRS 4002-005-020			2	2.17	2.25	2.33	2.42	2.62
HGLRS 4003-002-005	0.3	RO.02	0.5	0.63	0.66	0.69	0.72	0.78
HGLRS 4003-002-010			1	1.15	1.20	1.24	1.29	1.40
HGLRS 4003-002-015			1.5	1.66	1.72	1.79	1.85	2.01
HGLRS 4003-002-020		2	2.18	2.26	2.34	2.43	2.63	
HGLRS 4003-005-005		RO.05	0.5	0.63	0.66	0.68	0.71	0.77
HGLRS 4003-005-010			1	1.15	1.20	1.24	1.29	1.39
HGLRS 4003-005-020	2		2.18	2.26	2.34	2.43	2.62	
HGLRS 4004-002-010	0.4	RO.02	1	1.15	1.20	1.24	1.29	1.40
HGLRS 4004-002-020			2	2.18	2.26	2.34	2.43	2.63
HGLRS 4004-005-010		RO.05	1	1.15	1.20	1.24	1.29	1.39
HGLRS 4004-005-020			2	2.18	2.26	2.34	2.43	2.62
HGLRS 4004-01-010		RO.1	1	1.15	1.19	1.23	1.28	1.38
HGLRS 4004-01-020			2	2.18	2.25	2.33	2.42	2.61
HGLRS 4005-002-010	0.5	RO.02	1	1.15	1.20	1.24	1.29	1.40
HGLRS 4005-002-020			2	2.18	2.26	2.34	2.43	2.63
HGLRS 4005-002-030			3	3.21	3.33	3.45	3.58	3.87
HGLRS 4005-005-010		RO.05	1	1.15	1.20	1.24	1.29	1.39
HGLRS 4005-005-020			2	2.18	2.26	2.34	2.43	2.62
HGLRS 4005-005-030			3	3.21	3.33	3.45	3.58	3.87
HGLRS 4005-01-010		RO.1	1	1.15	1.19	1.23	1.28	1.38
HGLRS 4005-01-020			2	2.18	2.25	2.33	2.42	2.61
HGLRS 4005-01-030			3	3.21	3.32	3.44	3.57	3.85
HGLRS 4006-005-020	0.6	RO.05	2	2.18	2.26	2.34	2.43	2.62
HGLRS 4006-005-040			4	4.25	4.40	4.55	4.72	5.11
HGLRS 4006-01-020		RO.1	2	2.18	2.25	2.33	2.42	2.61
HGLRS 4006-01-040			4	4.25	4.39	4.55	4.72	5.10
HGLRS 4008-005-020	0.8	RO.05	2	2.54	2.72	2.89	3.03	3.30
HGLRS 4008-005-040			4	4.68	4.94	5.16	5.35	5.79
HGLRS 4008-005-060			6	6.80	7.11	7.37	7.65	8.27
HGLRS 4008-01-020		RO.1	2	2.54	2.72	2.88	3.02	3.29
HGLRS 4008-01-040			4	4.68	4.93	5.15	5.34	5.77
HGLRS 4008-01-060			6	6.79	7.11	7.37	7.64	8.26
HGLRS 4008-02-020		RO.2	2	2.53	2.70	2.86	3.00	3.26
HGLRS 4008-02-040			4	4.67	4.92	5.14	5.33	5.75
HGLRS 4008-02-060			6	6.78	7.10	7.36	7.63	8.24
HGLRS 4010-002-020			1	RO.02	2	2.58	2.76	2.92
HGLRS 4010-002-030	3	3.65			3.87	4.06	4.23	4.57
HGLRS 4010-002-040	4	4.71			4.97	5.18	5.38	5.81
HGLRS 4010-002-050	5	5.77			6.05	6.29	6.53	7.06

4 Flutes

Ø3mm Shank
V SeriesUDC-PCD
SeriesCBN
Series

Square

Long Neck
Square

Radius

Long Neck
RadiusTaper Neck
RadiusBall / Long
Shank BallLong Neck
BallTaper Neck
Ball

Taper

Barrel

Spiral
V Cutter

Drill

Technical Data

Unit (mm)

Model Number	Outside Diameter ϕD	Corner Radius CR	Effective Length ℓ_1	Length of Cut ℓ	Neck Diameter ϕd_1	Shank Taper Angle β	Overall Length L	Shank Diameter ϕd	Suggested Retail Price ¥				
HGLRS 4010-005-020	1	RO.05	2	0.8	0.98	16°	50	4	7,400				
HGLRS 4010-005-030			3				50	4	7,400				
HGLRS 4010-005-040			4				50	4	7,400				
HGLRS 4010-005-050			5				50	4	8,100				
HGLRS 4010-01-020		RO.1	2				50	4	7,400				
HGLRS 4010-01-030			3				50	4	7,400				
HGLRS 4010-01-040			4				50	4	7,400				
HGLRS 4010-01-050			5				50	4	8,100				
HGLRS 4010-02-020		RO.2	2				50	4	7,400				
HGLRS 4010-02-030			3				50	4	7,400				
HGLRS 4010-02-040			4				50	4	7,400				
HGLRS 4010-02-050			5				50	4	8,100				
HGLRS 4015-005-030	1.5	RO.05	3	1.2	1.48	16°	50	4	7,900				
HGLRS 4015-005-040			4				50	4	7,900				
HGLRS 4015-005-060			6				50	4	7,900				
HGLRS 4015-005-080			8				50	4	8,200				
HGLRS 4015-01-030		RO.1	3				50	4	7,900				
HGLRS 4015-01-040			4				50	4	7,900				
HGLRS 4015-01-060			6				50	4	7,900				
HGLRS 4015-01-080			8				50	4	8,200				
HGLRS 4015-02-030		RO.2	3				50	4	7,900				
HGLRS 4015-02-040			4				50	4	7,900				
HGLRS 4015-02-060			6				50	4	7,900				
HGLRS 4015-02-080			8				50	4	8,200				
HGLRS 4015-03-030		RO.3	3				50	4	7,900				
HGLRS 4015-03-040			4				50	4	7,900				
HGLRS 4015-03-060			6				50	4	7,900				
HGLRS 4015-03-080			8				50	4	8,200				
HGLRS 4015-05-040		RO.5	4				50	4	7,900				
HGLRS 4015-05-060			6				50	4	7,900				
HGLRS 4015-05-080			8				50	4	8,200				
HGLRS 4020-002-040			2				RO.02	4	1.6	1.96	16°	50	4
HGLRS 4020-002-060		6						50				4	7,900
HGLRS 4020-002-080		8						50				4	8,200
HGLRS 4020-002-100		10						50				4	8,200
HGLRS 4020-005-040		RO.05					4	50				4	7,900
HGLRS 4020-005-060	6			50	4	7,900							
HGLRS 4020-005-080	8			50	4	8,200							
HGLRS 4020-005-100	10			50	4	8,200							
HGLRS 4020-01-040	RO.1	4		50	4	7,900							
HGLRS 4020-01-060		6		50	4	7,900							
HGLRS 4020-01-080		8		50	4	8,200							
HGLRS 4020-01-100		10		50	4	8,200							
HGLRS 4020-02-040	RO.2	4		50	4	7,900							
HGLRS 4020-02-060		6		50	4	7,900							
HGLRS 4020-02-080		8		50	4	8,200							
HGLRS 4020-02-100		10		50	4	8,200							

- $\phi 3$ mm Shank V Series
- UDC-PCD Series
- CBN Series
- Square
- Long Neck Square
- Radius
- Long Neck Radius
- Taper Neck Radius
- Ball / Long Shank Ball
- Long Neck Ball
- Taper Neck Ball
- Taper
- Barrel
- Spiral V Cutter
- Drill
- Technical Data

Unit (mm)

Model Number	Outside Diameter ϕD	Corner Radius CR	Effective Length l_1	Effective Length by Inclined Angles					
				30'	1°	1°30'	2°	3°	
HGLRS 4010-005-020	1	RO.05	2	2.58	2.76	2.91	3.06	3.32	
HGLRS 4010-005-030			3	3.65	3.87	4.05	4.22	4.56	
HGLRS 4010-005-040			4	4.71	4.96	5.18	5.37	5.81	
HGLRS 4010-005-050			5	5.77	6.05	6.29	6.52	7.05	
HGLRS 4010-01-020		RO.1	2	2.58	2.75	2.90	3.05	3.31	
HGLRS 4010-01-030			3	3.65	3.86	4.05	4.21	4.55	
HGLRS 4010-01-040			4	4.71	4.96	5.17	5.36	5.80	
HGLRS 4010-01-050			5	5.77	6.05	6.28	6.51	7.04	
HGLRS 4010-02-020		RO.2	2	2.57	2.74	2.89	3.03	3.29	
HGLRS 4010-02-030			3	3.64	3.85	4.03	4.20	4.53	
HGLRS 4010-02-040			4	4.70	4.95	5.16	5.35	5.77	
HGLRS 4010-02-050			5	5.76	6.04	6.27	6.50	7.02	
HGLRS 4015-005-030		1.5	RO.05	3	3.12	3.23	3.35	3.48	3.76
HGLRS 4015-005-040				4	4.16	4.30	4.46	4.63	5.00
HGLRS 4015-005-060				6	6.22	6.44	6.67	6.92	7.49
HGLRS 4015-005-080				8	8.29	8.58	8.89	9.22	9.97
HGLRS 4015-01-030	RO.1		3	3.12	3.23	3.34	3.47	3.75	
HGLRS 4015-01-040			4	4.16	4.30	4.45	4.62	4.99	
HGLRS 4015-01-060			6	6.22	6.44	6.67	6.92	7.48	
HGLRS 4015-01-080			8	8.29	8.58	8.89	9.22	9.96	
HGLRS 4015-02-030	RO.2		3	3.12	3.22	3.33	3.45	3.72	
HGLRS 4015-02-040			4	4.15	4.29	4.44	4.60	4.97	
HGLRS 4015-02-060			6	6.22	6.43	6.66	6.90	7.45	
HGLRS 4015-02-080			8	8.29	8.57	8.87	9.20	9.94	
HGLRS 4015-03-030	RO.3		3	3.12	3.22	3.32	3.44	3.70	
HGLRS 4015-03-040			4	4.15	4.28	4.43	4.59	4.94	
HGLRS 4015-03-060			6	6.22	6.42	6.65	6.89	7.43	
HGLRS 4015-03-080			8	8.28	8.56	8.86	9.19	9.91	
HGLRS 4015-05-040	RO.5	4	4.14	4.27	4.41	4.56	4.89		
HGLRS 4015-05-060		6	6.21	6.41	6.63	6.86	7.38		
HGLRS 4015-05-080		8	8.28	8.55	8.84	9.16	9.87		
HGLRS 4020-002-040		2	RO.02	4	4.20	4.34	4.50	4.67	5.05
HGLRS 4020-002-060	6			6.26	6.48	6.72	6.97	7.54	
HGLRS 4020-002-080	8			8.33	8.62	8.94	9.27	10.03	
HGLRS 4020-002-100	10			10.40	10.76	11.15	11.57	12.51	
HGLRS 4020-005-040	RO.05		4	4.20	4.34	4.50	4.67	5.05	
HGLRS 4020-005-060			6	6.26	6.48	6.72	6.97	7.53	
HGLRS 4020-005-080			8	8.33	8.62	8.93	9.27	10.02	
HGLRS 4020-005-100			10	10.40	10.76	11.15	11.57	12.51	
HGLRS 4020-01-040	RO.1		4	4.19	4.34	4.49	4.66	5.04	
HGLRS 4020-01-060			6	6.26	6.48	6.71	6.96	7.52	
HGLRS 4020-01-080			8	8.33	8.62	8.93	9.26	10.01	
HGLRS 4020-01-100			10	10.40	10.76	11.14	11.56	12.49	
HGLRS 4020-02-040	RO.2		4	4.19	4.33	4.48	4.65	5.01	
HGLRS 4020-02-060			6	6.26	6.47	6.70	6.95	7.50	
HGLRS 4020-02-080			8	8.33	8.61	8.92	9.25	9.98	
HGLRS 4020-02-100			10	10.39	10.75	11.13	11.54	12.47	

4 Flutes

 $\phi 3$ mm Shank
V SeriesUDC-PCD
SeriesCBN
SeriesSquare
Long Neck
SquareRadius
Long Neck
RadiusTaper Neck
RadiusBall / Long
Shank BallLong Neck
BallTaper Neck
Ball

Taper

Barrel

Spiral
V Cutter

Drill

Technical Data

Next Page →

Unit (mm)

Model Number	Outside Diameter ϕD	Corner Radius CR	Effective Length ℓ_1	Length of Cut ℓ	Neck Diameter ϕd_1	Shank Taper Angle β	Overall Length L	Shank Diameter ϕd	Suggested Retail Price ¥					
HGLRS 4020-03-040	2	RO.3	4	1.6	1.96	16°	50	4	7,900					
HGLRS 4020-03-060			6				50	4	7,900					
HGLRS 4020-03-080			8				50	4	8,200					
HGLRS 4020-03-100			10				50	4	8,200					
HGLRS 4020-05-040		RO.5	4				50	4	7,900					
HGLRS 4020-05-060			6				50	4	7,900					
HGLRS 4020-05-080			8				50	4	8,200					
HGLRS 4020-05-100			10				50	4	8,200					
HGLRS 4030-005-040			3				RO.05	4	2.4	2.87	16°	50	6	7,100
HGLRS 4030-005-060								6				50	6	7,100
HGLRS 4030-005-080	8	50		6	7,100									
HGLRS 4030-005-100	10	50		6	7,100									
HGLRS 4030-005-120	12	50		6	8,600									
HGLRS 4030-005-160	16	60		6	10,600									
HGLRS 4030-01-040	RO.1	4		50	6	7,100								
HGLRS 4030-01-060		6		50	6	7,100								
HGLRS 4030-01-080		8		50	6	7,100								
HGLRS 4030-01-100		10		50	6	7,100								
HGLRS 4030-01-120		12		50	6	8,600								
HGLRS 4030-01-160		16		60	6	10,600								
HGLRS 4030-02-040	RO.2	4		50	6	7,100								
HGLRS 4030-02-060		6		50	6	7,100								
HGLRS 4030-02-080		8		50	6	7,100								
HGLRS 4030-02-100		10		50	6	7,100								
HGLRS 4030-02-120		12		50	6	8,600								
HGLRS 4030-02-160		16		60	6	10,600								
HGLRS 4030-03-040	RO.3	4	50	6	7,100									
HGLRS 4030-03-060		6	50	6	7,100									
HGLRS 4030-03-080		8	50	6	7,100									
HGLRS 4030-03-100		10	50	6	7,100									
HGLRS 4030-03-120		12	50	6	8,600									
HGLRS 4030-03-160		16	60	6	10,600									
HGLRS 4030-05-040	RO.5	4	50	6	7,100									
HGLRS 4030-05-060		6	50	6	7,100									
HGLRS 4030-05-080		8	50	6	7,100									
HGLRS 4030-05-100		10	50	6	7,100									
HGLRS 4030-05-120		12	50	6	8,600									
HGLRS 4030-05-160		16	60	6	10,600									
HGLRS 4030-10-060	R1	6	50	6	7,100									
HGLRS 4030-10-080		8	50	6	7,100									
HGLRS 4030-10-100		10	50	6	7,100									
HGLRS 4030-10-120		12	50	6	8,600									
HGLRS 4030-10-160		16	60	6	10,600									
HGLRS 4040-005-080		4	RO.05	8	3.2	3.77	16°	60	6	10,600				
HGLRS 4040-005-120	12			60				6	10,600					
HGLRS 4040-005-160	16			60				6	10,600					
HGLRS 4040-005-200	20			70				6	11,800					

Next Page ➡

- $\phi 3$ mm Shank V Series
- UDC-PCD Series
- CBN Series
- Square
- Long Neck Square
- Radius
- Long Neck Radius
- Taper Neck Radius
- Ball / Long Shank Ball
- Long Neck Ball
- Taper Neck Ball
- Taper
- Barrel
- Spiral V Cutter
- Drill
- Technical Data

Unit (mm)

Model Number	Outside Diameter ϕD	Corner Radius CR	Effective Length l_1	Effective Length by Inclined Angles					
				30'	1°	1°30'	2°	3°	
HGLRS 4020-03-040	2	RO.3	4	4.19	4.32	4.47	4.63	4.99	
HGLRS 4020-03-060			6	6.25	6.46	6.69	6.93	7.47	
HGLRS 4020-03-080			8	8.32	8.60	8.91	9.23	9.96	
HGLRS 4020-03-100			10	10.39	10.74	11.12	11.53	12.45	
HGLRS 4020-05-040		RO.5	4	4.18	4.31	4.45	4.60	4.94	
HGLRS 4020-05-060			6	6.25	6.45	6.67	6.90	7.43	
HGLRS 4020-05-080			8	8.32	8.59	8.88	9.20	9.91	
HGLRS 4020-05-100			10	10.38	10.73	11.10	11.50	12.40	
HGLRS 4030-005-040		3	RO.05	4	4.39	4.54	4.70	4.88	5.28
HGLRS 4030-005-060				6	6.45	6.68	6.92	7.18	7.76
HGLRS 4030-005-080	8			8.52	8.82	9.14	9.48	10.25	
HGLRS 4030-005-100	10			10.59	10.96	11.35	11.78	12.74	
HGLRS 4030-005-120	12			12.66	13.10	13.57	14.08	15.22	
HGLRS 4030-005-160	16			16.79	17.38	18.00	18.68	20.19	
HGLRS 4030-01-040	RO.1		4	4.38	4.54	4.70	4.87	5.27	
HGLRS 4030-01-060			6	6.45	6.68	6.92	7.17	7.75	
HGLRS 4030-01-080			8	8.52	8.81	9.13	9.47	10.24	
HGLRS 4030-01-100			10	10.59	10.95	11.35	11.77	12.72	
HGLRS 4030-01-120			12	12.65	13.09	13.56	14.07	15.21	
HGLRS 4030-01-160			16	16.79	17.37	18.00	18.67	20.18	
HGLRS 4030-02-040	RO.2		4	4.38	4.53	4.69	4.86	5.24	
HGLRS 4030-02-060			6	6.45	6.67	6.90	7.16	7.73	
HGLRS 4030-02-080			8	8.52	8.81	9.12	9.46	10.21	
HGLRS 4030-02-100			10	10.58	10.95	11.34	11.76	12.70	
HGLRS 4030-02-120		12	12.65	13.09	13.55	14.06	15.19		
HGLRS 4030-02-160		16	16.79	17.37	17.99	18.66	20.16		
HGLRS 4030-03-040	3	RO.3	4	4.38	4.52	4.68	4.84	5.22	
HGLRS 4030-03-060			6	6.45	6.66	6.89	7.14	7.70	
HGLRS 4030-03-080			8	8.51	8.80	9.11	9.44	10.19	
HGLRS 4030-03-100			10	10.58	10.94	11.33	11.74	12.68	
HGLRS 4030-03-120			12	12.65	13.08	13.54	14.04	15.16	
HGLRS 4030-03-160			16	16.78	17.36	17.98	18.64	20.14	
HGLRS 4030-05-040		RO.5	4	4.37	4.51	4.66	4.81	5.17	
HGLRS 4030-05-060			6	6.44	6.65	6.87	7.11	7.66	
HGLRS 4030-05-080			8	8.51	8.79	9.09	9.41	10.14	
HGLRS 4030-05-100			10	10.57	10.93	11.31	11.71	12.63	
HGLRS 4030-05-120	12		12.64	13.07	13.52	14.01	15.12		
HGLRS 4030-05-160	16		16.78	17.34	17.96	18.61	20.09		
HGLRS 4030-10-060	R1	6	6.42	6.61	6.81	7.04	7.53		
HGLRS 4030-10-080		8	8.49	8.75	9.03	9.34	10.02		
HGLRS 4030-10-100		10	10.55	10.89	11.25	11.64	12.51		
HGLRS 4030-10-120		12	12.62	13.03	13.46	13.94	14.99		
HGLRS 4030-10-160		16	16.75	17.31	17.90	18.53	19.97		
HGLRS 4040-005-080	4	RO.05	8	8.71	9.02	9.34	9.69	10.48	
HGLRS 4040-005-120			12	12.85	13.29	13.78	14.29	15.45	
HGLRS 4040-005-160			16	16.98	17.57	18.21	18.89	No Interference	
HGLRS 4040-005-200			20	21.12	21.85	22.64	23.49	No Interference	

4 Flutes

Ø3mm Shank
V SeriesUDC-PCD
SeriesCBN
SeriesSquare
Square
Long Neck
SquareRadius
Radius
Long Neck
RadiusTaper Neck
RadiusBall / Long
Shank BallBall
Long Neck
BallTaper Neck
BallTaper
Taper

Barrel

Spiral
V Cutter

Drill

Technical Data

Next Page →

351

Unit (mm)

Model Number	Outside Diameter ϕD	Corner Radius CR	Effective Length ℓ_1	Length of Cut ℓ	Neck Diameter ϕd_1	Shank Taper Angle β	Overall Length L	Shank Diameter ϕd	Suggested Retail Price ¥
HGLRS 4040-01-080	4	RO.1	8	3.2	3.77	16°	60	6	10,600
HGLRS 4040-01-120			12				60	6	10,600
HGLRS 4040-01-160			16				60	6	10,600
HGLRS 4040-01-200			20				70	6	11,800
HGLRS 4040-02-080		RO.2	8				60	6	10,600
HGLRS 4040-02-120			12				60	6	10,600
HGLRS 4040-02-160			16				60	6	10,600
HGLRS 4040-02-200			20				70	6	11,800
HGLRS 4040-03-080		RO.3	8				60	6	10,600
HGLRS 4040-03-120			12				60	6	10,600
HGLRS 4040-03-160			16				60	6	10,600
HGLRS 4040-03-200			20				70	6	11,800
HGLRS 4040-05-080		RO.5	8				60	6	10,600
HGLRS 4040-05-120			12				60	6	10,600
HGLRS 4040-05-160			16				60	6	10,600
HGLRS 4040-05-200			20				70	6	11,800
HGLRS 4040-10-080	R1	8	60	6	10,600				
HGLRS 4040-10-120		12	60	6	10,600				
HGLRS 4040-10-160		16	60	6	10,600				
HGLRS 4040-10-200		20	70	6	11,800				
HGLRS 4060-01-120	6	RO.1	12	4.8	5.77	—	60	6	15,400
HGLRS 4060-01-160			16				60	6	15,400
HGLRS 4060-01-200			20				70	6	15,400
HGLRS 4060-01-240			24				70	6	15,400
HGLRS 4060-01-300			30				100	6	18,000
HGLRS 4060-02-120			RO.2				12	60	6
HGLRS 4060-02-160		16					60	6	15,400
HGLRS 4060-02-200		20					70	6	15,400
HGLRS 4060-02-240		24					70	6	15,400
HGLRS 4060-02-300		30					100	6	18,000
HGLRS 4060-03-120		RO.3					12	60	6
HGLRS 4060-03-160			16				60	6	15,400
HGLRS 4060-03-200			20				70	6	15,400
HGLRS 4060-03-240			24				70	6	15,400
HGLRS 4060-03-300			30				100	6	18,000
HGLRS 4060-05-120			RO.5				12	60	6
HGLRS 4060-05-160		16					60	6	15,400
HGLRS 4060-05-200		20					70	6	15,400
HGLRS 4060-05-240		24					70	6	15,400
HGLRS 4060-05-300		30					100	6	18,000
HGLRS 4060-10-120		R1					12	60	6
HGLRS 4060-10-160			16				60	6	15,400
HGLRS 4060-10-200			20				70	6	15,400
HGLRS 4060-10-240			24				70	6	15,400
HGLRS 4060-10-300	30		100	6	18,000				

Next Page ➡

- 3mm Shank V Series
- UDC-PCD Series
- CBN Series
- Square
- Long Neck Square
- Radius
- Long Neck Radius
- Taper Neck Radius
- Ball / Long Shank Ball
- Long Neck Ball
- Taper Neck Ball
- Taper
- Barrel
- Spiral V Cutter
- Drill
- Technical Data

Unit (mm)

Model Number	Outside Diameter ϕD	Corner Radius CR	Effective Length l_1	Effective Length by Inclined Angles				
				30°	1°	1°30'	2°	3°
HGLRS 4040-01-080	4	RO.1	8	8.71	9.01	9.34	9.68	10.47
HGLRS 4040-01-120			12	12.85	13.29	13.77	14.28	15.44
HGLRS 4040-01-160			16	16.98	17.57	18.20	18.88	No Interference
HGLRS 4040-01-200			20	21.11	21.85	22.64	23.48	No Interference
HGLRS 4040-02-080		RO.2	8	8.71	9.01	9.33	9.67	10.44
HGLRS 4040-02-120			12	12.84	13.28	13.76	14.27	15.42
HGLRS 4040-02-160			16	16.98	17.56	18.19	18.87	No Interference
HGLRS 4040-02-200			20	21.11	21.84	22.63	23.47	No Interference
HGLRS 4040-03-080		RO.3	8	8.70	9.00	9.32	9.66	10.42
HGLRS 4040-03-120			12	12.84	13.28	13.75	14.25	15.39
HGLRS 4040-03-160			16	16.97	17.56	18.18	18.85	No Interference
HGLRS 4040-03-200			20	21.11	21.83	22.61	23.45	No Interference
HGLRS 4040-05-080		RO.5	8	8.70	8.98	9.29	9.63	10.37
HGLRS 4040-05-120			12	12.83	13.26	13.73	14.23	15.35
HGLRS 4040-05-160			16	16.97	17.54	18.16	18.82	No Interference
HGLRS 4040-05-200			20	21.10	21.82	22.59	23.42	No Interference
HGLRS 4040-10-080		R1	8	8.68	8.95	9.24	9.55	10.25
HGLRS 4040-10-120			12	12.81	13.23	13.67	14.15	15.22
HGLRS 4040-10-160			16	16.95	17.50	18.10	18.75	20.19
HGLRS 4040-10-200			20	21.08	21.78	22.54	23.35	No Interference
HGLRS 4060-01-120	6	RO.1	12	No Interference	No Interference	No Interference	No Interference	No Interference
HGLRS 4060-01-160			16	No Interference	No Interference	No Interference	No Interference	No Interference
HGLRS 4060-01-200			20	No Interference	No Interference	No Interference	No Interference	No Interference
HGLRS 4060-01-240			24	No Interference	No Interference	No Interference	No Interference	No Interference
HGLRS 4060-01-300			30	No Interference	No Interference	No Interference	No Interference	No Interference
HGLRS 4060-02-120		RO.2	12	No Interference	No Interference	No Interference	No Interference	No Interference
HGLRS 4060-02-160			16	No Interference	No Interference	No Interference	No Interference	No Interference
HGLRS 4060-02-200			20	No Interference	No Interference	No Interference	No Interference	No Interference
HGLRS 4060-02-240			24	No Interference	No Interference	No Interference	No Interference	No Interference
HGLRS 4060-02-300			30	No Interference	No Interference	No Interference	No Interference	No Interference
HGLRS 4060-03-120		RO.3	12	No Interference	No Interference	No Interference	No Interference	No Interference
HGLRS 4060-03-160			16	No Interference	No Interference	No Interference	No Interference	No Interference
HGLRS 4060-03-200			20	No Interference	No Interference	No Interference	No Interference	No Interference
HGLRS 4060-03-240			24	No Interference	No Interference	No Interference	No Interference	No Interference
HGLRS 4060-03-300			30	No Interference	No Interference	No Interference	No Interference	No Interference
HGLRS 4060-05-120		RO.5	12	No Interference	No Interference	No Interference	No Interference	No Interference
HGLRS 4060-05-160			16	No Interference	No Interference	No Interference	No Interference	No Interference
HGLRS 4060-05-200			20	No Interference	No Interference	No Interference	No Interference	No Interference
HGLRS 4060-05-240			24	No Interference	No Interference	No Interference	No Interference	No Interference
HGLRS 4060-05-300			30	No Interference	No Interference	No Interference	No Interference	No Interference
HGLRS 4060-10-120		R1	12	No Interference	No Interference	No Interference	No Interference	No Interference
HGLRS 4060-10-160			16	No Interference	No Interference	No Interference	No Interference	No Interference
HGLRS 4060-10-200			20	No Interference	No Interference	No Interference	No Interference	No Interference
HGLRS 4060-10-240			24	No Interference	No Interference	No Interference	No Interference	No Interference
HGLRS 4060-10-300			30	No Interference	No Interference	No Interference	No Interference	No Interference

4 Flutes

$\phi 3$ mm Shank V Series

UDC-PCD Series

CBN Series

Square

Long Neck Square

Radius

Long Neck Radius

Taper Neck Radius

Ball / Long Shank Ball

Long Neck Ball

Taper Neck Ball

Taper

Barrel

Spiral V Cutter

Drill

Technical Data

Milling Conditions for HGLRS

WORK MATERIAL				PREHARDENED STEELS / HARDENED STEELS NAK / STAVAX (~55HRC)				HARDENED STEELS SKD11 (55~62HRC)				HARDENED STEELS HAP10 (62~66HRC)				HARDENED STEELS HAP72 (66~70HRC)					
Model Number	Outside Diameter (mm)	Corner Radius (mm)	Effective Length (mm)	Spindle Speed (min ⁻¹)	Feed Rate (mm/min)	a _p Axial Depth (mm)	a _e Radial Depth (mm)	Spindle Speed (min ⁻¹)	Feed Rate (mm/min)	a _p Axial Depth (mm)	a _e Radial Depth (mm)	Spindle Speed (min ⁻¹)	Feed Rate (mm/min)	a _p Axial Depth (mm)	a _e Radial Depth (mm)	Spindle Speed (min ⁻¹)	Feed Rate (mm/min)	a _p Axial Depth (mm)	a _e Radial Depth (mm)		
4002	0.2	R0.02	0.5	27,000	500	0.004	0.05	27,000	260	0.003	0.02	27,000	280	0.003	0.01	27,000	250	0.003	0.01		
			1	27,000	390	0.004	0.05	27,000	170	0.003	0.02	27,000	210	0.003	0.01	27,000	190	0.003	0.01		
			2	27,000	80	0.004	0.05	27,000	25	0.003	0.02	27,000	30	0.003	0.01	27,000	25	0.003	0.01		
		R0.05	0.5	27,000	590	0.004	0.05	27,000	260	0.003	0.02	27,000	280	0.003	0.01	27,000	250	0.003	0.01		
			1	27,000	450	0.004	0.05	27,000	170	0.003	0.02	27,000	210	0.003	0.01	27,000	190	0.003	0.01		
			2	27,000	80	0.004	0.05	27,000	25	0.003	0.02	27,000	30	0.003	0.01	27,000	25	0.003	0.01		
4003	0.3	R0.02	0.5	25,500	600	0.008	0.09	25,500	460	0.003	0.04	25,500	480	0.003	0.03	25,000	440	0.003	0.03		
			1	25,500	480	0.008	0.09	25,500	440	0.003	0.04	25,500	460	0.003	0.03	25,000	420	0.003	0.03		
			1.5	25,500	360	0.008	0.09	25,500	280	0.003	0.04	25,500	300	0.003	0.03	25,000	270	0.003	0.03		
		R0.05	2	25,500	240	0.008	0.09	25,500	200	0.003	0.04	25,500	220	0.003	0.03	25,000	200	0.003	0.03		
			0.5	25,500	700	0.008	0.09	25,500	460	0.003	0.04	25,500	480	0.004	0.03	25,000	440	0.004	0.03		
			1	25,500	560	0.008	0.09	25,500	440	0.003	0.04	25,500	460	0.004	0.03	25,000	420	0.004	0.03		
4004	0.4	R0.02	1	23,000	720	0.01	0.13	18,300	700	0.004	0.07	20,500	720	0.003	0.05	20,000	650	0.003	0.05		
			2	20,500	540	0.01	0.13	16,100	420	0.004	0.07	18,000	440	0.003	0.05	17,500	400	0.003	0.05		
			1	23,000	840	0.015	0.13	18,300	700	0.004	0.07	20,500	720	0.004	0.05	20,000	650	0.004	0.05		
		R0.05	2	20,500	630	0.015	0.13	16,100	420	0.006	0.07	18,000	440	0.004	0.05	17,500	400	0.004	0.05		
			1	23,000	840	0.015	0.13	18,300	700	0.006	0.07	20,500	720	0.007	0.05	20,000	650	0.007	0.05		
			2	20,500	630	0.015	0.13	16,100	420	0.006	0.07	18,000	440	0.007	0.05	17,500	400	0.007	0.05		
4005	0.5	R0.02	1	22,500	920	0.01	0.17	17,900	880	0.006	0.09	20,000	900	0.004	0.07	19,500	820	0.004	0.07		
			2	20,000	830	0.01	0.17	15,700	660	0.006	0.09	17,500	680	0.004	0.07	17,000	620	0.004	0.07		
			3	18,000	730	0.01	0.17	13,900	530	0.006	0.09	15,500	550	0.004	0.07	15,000	500	0.004	0.07		
		R0.05	1	22,500	1,080	0.017	0.17	17,900	880	0.009	0.09	20,000	900	0.007	0.07	19,500	820	0.007	0.07		
			2	20,000	970	0.017	0.17	15,700	660	0.009	0.09	17,500	680	0.007	0.07	17,000	620	0.007	0.07		
			3	18,000	850	0.017	0.17	13,900	530	0.009	0.09	15,500	550	0.007	0.07	15,000	500	0.007	0.07		
R0.1	1	22,500	1,080	0.017	0.17	17,900	880	0.009	0.09	20,000	900	0.007	0.07	19,500	820	0.007	0.07				
	2	20,000	970	0.017	0.17	15,700	660	0.009	0.09	17,500	680	0.007	0.07	17,000	620	0.007	0.07				
	3	18,000	850	0.017	0.17	13,900	530	0.009	0.09	15,500	550	0.007	0.07	15,000	500	0.007	0.07				
4006	0.6	R0.05	2	21,500	1,050	0.021	0.2	17,000	710	0.015	0.12	19,000	730	0.007	0.1	18,500	660	0.007	0.1		
			4	17,000	730	0.021	0.2	13,000	310	0.015	0.12	14,500	330	0.007	0.1	14,000	300	0.007	0.1		
		R0.1	2	21,500	1,050	0.021	0.2	17,000	710	0.015	0.12	19,000	730	0.007	0.1	18,500	660	0.007	0.1		
			4	17,000	730	0.021	0.2	13,000	310	0.015	0.12	14,500	330	0.007	0.1	14,000	300	0.007	0.1		
		4008	0.8	R0.05	2	20,500	1,330	0.028	0.26	15,700	830	0.02	0.16	17,500	850	0.01	0.15	15,500	770	0.01	0.15
					4	16,500	1,020	0.028	0.26	12,500	530	0.02	0.16	14,000	550	0.01	0.15	13,500	500	0.01	0.15
6	14,000				840	0.028	0.26	10,300	420	0.02	0.16	11,500	440	0.01	0.15	11,000	400	0.01	0.15		
R0.1	2			20,500	1,330	0.028	0.26	15,700	830	0.02	0.16	17,500	850	0.01	0.15	15,500	770	0.01	0.15		
	4			16,500	1,020	0.028	0.26	12,500	640	0.02	0.16	14,000	660	0.01	0.15	13,500	600	0.01	0.15		
	6			14,000	840	0.028	0.26	10,300	420	0.02	0.16	11,500	440	0.01	0.15	11,000	400	0.01	0.15		
R0.2	2	20,500	1,330	0.028	0.26	15,700	830	0.02	0.16	17,500	850	0.015	0.15	15,500	770	0.015	0.15				
	4	16,500	1,020	0.028	0.26	12,500	640	0.02	0.16	14,000	660	0.015	0.15	13,500	600	0.015	0.15				
	6	14,000	840	0.028	0.26	10,300	420	0.02	0.16	11,500	440	0.015	0.15	11,000	400	0.015	0.15				

- φ3mm Shank V Series
- UDC-PCD Series
- CBN Series
- Square
- Long Neck Square
- Radius
- Long Neck Radius
- Taper Neck Radius
- Ball / Long Shank Ball
- Long Neck Ball
- Taper Neck Ball
- Taper
- Barrel
- Spiral V Cutter
- Drill
- Technical Data

Milling Conditions for HGLRS

WORK MATERIAL				PREHARDENED STEELS / HARDENED STEELS NAK / STAVAX (~55HRC)				HARDENED STEELS SKD11 (55~62HRC)				HARDENED STEELS HAP10 (62~66HRC)				HARDENED STEELS HAP72 (66~70HRC)			
Model Number	Outside Diameter (mm)	Corner Radius (mm)	Effective Length (mm)	Spindle Speed (min ⁻¹)	Feed Rate (mm/min)	a _p Axial Depth (mm)	a _e Radial Depth (mm)	Spindle Speed (min ⁻¹)	Feed Rate (mm/min)	a _p Axial Depth (mm)	a _e Radial Depth (mm)	Spindle Speed (min ⁻¹)	Feed Rate (mm/min)	a _p Axial Depth (mm)	a _e Radial Depth (mm)	Spindle Speed (min ⁻¹)	Feed Rate (mm/min)	a _p Axial Depth (mm)	a _e Radial Depth (mm)
4010	1	R0.02	2	15,300	1,200	0.004	0.027	10,300	710	0.003	0.003	8,900	800	0.003	0.003	8,600	780	0.003	0.003
			3	13,200	1,150	0.004	0.027	9,400	680	0.003	0.003	8,500	770	0.003	0.003	8,300	750	0.003	0.003
			4	12,000	1,070	0.003	0.024	8,500	640	0.003	0.003	8,100	730	0.003	0.003	7,900	710	0.003	0.003
			5	11,000	960	0.003	0.023	7,800	570	0.003	0.003	7,700	700	0.003	0.003	7,500	680	0.003	0.003
		R0.05	2	15,300	1,200	0.01	0.068	10,300	710	0.005	0.006	8,900	800	0.004	0.004	8,600	780	0.004	0.004
			3	13,200	1,150	0.009	0.068	9,400	680	0.004	0.005	8,500	770	0.004	0.003	8,300	750	0.004	0.003
			4	12,000	1,070	0.008	0.061	8,500	640	0.004	0.005	8,100	730	0.004	0.003	7,900	710	0.004	0.003
		R0.1 R0.2	5	11,000	960	0.007	0.058	7,800	570	0.003	0.004	7,700	700	0.003	0.003	7,500	680	0.003	0.003
			2	15,300	1,200	0.04	0.27	10,300	710	0.03	0.27	8,900	800	0.02	0.27	8,600	780	0.02	0.26
			3	13,200	1,150	0.04	0.27	9,400	680	0.03	0.27	8,500	770	0.02	0.25	8,300	750	0.02	0.24
			4	12,000	1,070	0.03	0.24	8,500	640	0.02	0.24	8,100	730	0.01	0.23	7,900	710	0.01	0.22
			5	11,000	960	0.03	0.23	7,800	570	0.01	0.14	7,700	700	0.01	0.21	7,500	680	0.01	0.2
4015	1.5	R0.05	3	14,800	1,330	0.013	0.135	8,900	760	0.005	0.007	8,800	870	0.005	0.006	8,500	840	0.005	0.006
			4	13,200	1,280	0.011	0.124	8,600	740	0.005	0.007	8,500	840	0.005	0.005	8,300	820	0.005	0.005
			6	10,600	1,210	0.01	0.111	8,100	690	0.004	0.006	8,000	790	0.004	0.005	7,800	770	0.004	0.005
		R0.1 R0.2 R0.3 R0.5	8	9,300	1,020	0.008	0.087	7,900	690	0.004	0.006	7,700	780	0.004	0.004	7,500	760	0.004	0.004
			3	14,800	1,330	0.05	0.54	8,900	760	0.02	0.66	8,800	870	0.02	0.41	8,500	840	0.02	0.4
			4	13,200	1,280	0.04	0.5	8,600	740	0.02	0.62	8,500	840	0.02	0.39	8,300	820	0.02	0.38
			6	10,600	1,210	0.04	0.45	8,100	690	0.02	0.56	8,000	790	0.02	0.35	7,800	770	0.02	0.34
			8	9,300	1,020	0.03	0.35	7,600	650	0.02	0.52	7,500	740	0.02	0.31	7,300	720	0.02	0.3
4020	2	R0.02	4	14,300	1,460	0.01	0.118	8,600	860	0.003	0.003	8,500	930	0.003	0.003	8,300	900	0.003	0.003
			6	12,000	1,200	0.006	0.109	8,300	830	0.003	0.003	8,100	890	0.003	0.003	7,900	860	0.003	0.003
			8	10,400	1,100	0.006	0.1	7,900	790	0.003	0.003	7,800	840	0.003	0.003	7,600	820	0.003	0.003
			10	9,300	1,020	0.005	0.086	7,500	750	0.003	0.003	7,400	800	0.003	0.003	7,200	780	0.003	0.003
		R0.05	4	14,300	1,460	0.016	0.24	8,600	860	0.007	0.01	8,500	930	0.007	0.007	8,300	900	0.007	0.007
			6	12,000	1,200	0.015	0.219	8,300	830	0.006	0.009	8,100	890	0.006	0.007	7,900	860	0.006	0.007
			8	10,400	1,100	0.014	0.197	7,900	790	0.006	0.008	7,800	840	0.006	0.006	7,600	820	0.006	0.006
			10	9,300	1,020	0.012	0.165	7,500	750	0.005	0.008	7,400	800	0.005	0.006	7,200	780	0.005	0.006
		R0.1	4	14,300	1,460	0.033	0.405	8,600	860	0.013	0.18	8,500	930	0.013	0.134	8,300	900	0.013	0.13
			6	12,000	1,200	0.03	0.365	8,300	830	0.012	0.166	8,100	890	0.012	0.124	7,900	860	0.012	0.12
			8	10,400	1,100	0.028	0.324	7,900	790	0.011	0.152	7,800	840	0.011	0.113	7,600	820	0.011	0.11
			10	9,300	1,020	0.024	0.263	7,500	750	0.01	0.138	7,400	800	0.01	0.103	7,200	780	0.01	0.1
R0.2 R0.3 R0.5	4	14,300	1,460	0.07	0.81	8,600	860	0.03	0.9	8,500	930	0.03	0.54	8,300	900	0.03	0.52		
	6	12,000	1,200	0.06	0.73	8,300	830	0.02	0.83	8,100	890	0.02	0.49	7,900	860	0.02	0.48		
	8	10,400	1,100	0.06	0.65	7,900	790	0.02	0.76	7,800	840	0.02	0.45	7,600	820	0.02	0.44		
	10	9,300	1,020	0.05	0.53	7,500	750	0.02	0.69	7,400	800	0.02	0.41	7,200	780	0.02	0.4		

4 Flutes

- Ø3mm Shank V Series
- UDC-PCD Series
- CBN Series
- Square
- Square
- Long Neck Square
- Radius
- Radius
- Long Neck Radius
- Taper Neck Radius
- Ball / Long Shank Ball
- Ball
- Long Neck Ball
- Taper Neck Ball
- Taper
- Taper
- Barrel
- Spiral V Cutter
- Drill
- Technical Data

Milling Conditions for HGLRS

WORK MATERIAL				PREHARDENED STEELS / HARDENED STEELS NAK / STAVAX (~55HRC)				HARDENED STEELS SKD11 (55~62HRC)				HARDENED STEELS HAP10 (62~66HRC)				HARDENED STEELS HAP72 (66~70HRC)					
Model Number	Outside Diameter (mm)	Corner Radius (mm)	Effective Length (mm)	Spindle Speed (min ⁻¹)	Feed Rate (mm/min)	a _p Axial Depth (mm)	a _e Radial Depth (mm)	Spindle Speed (min ⁻¹)	Feed Rate (mm/min)	a _p Axial Depth (mm)	a _e Radial Depth (mm)	Spindle Speed (min ⁻¹)	Feed Rate (mm/min)	a _p Axial Depth (mm)	a _e Radial Depth (mm)	Spindle Speed (min ⁻¹)	Feed Rate (mm/min)	a _p Axial Depth (mm)	a _e Radial Depth (mm)		
4030	3	R0.05	4	14,000	2,640	0.02	0.18	8,900	1,140	0.011	0.013	8,700	1,110	0.011	0.012	8,400	1,080	0.011	0.012		
			6	13,300	2,500	0.019	0.18	8,600	1,110	0.01	0.012	8,400	1,080	0.01	0.011	8,200	1,050	0.01	0.011		
			8	11,800	2,200	0.018	0.175	8,400	1,080	0.01	0.012	8,100	1,050	0.01	0.011	7,900	1,020	0.01	0.011		
			10	10,500	2,090	0.015	0.175	8,100	1,050	0.009	0.011	7,900	1,020	0.009	0.01	7,700	990	0.009	0.01		
			12	10,000	1,950	0.013	0.168	7,900	1,010	0.009	0.01	7,700	990	0.009	0.01	7,500	960	0.009	0.009		
			16	8,800	1,600	0.01	0.158	7,400	950	0.008	0.01	7,200	930	0.008	0.009	7,000	900	0.008	0.008		
		R0.1	4	14,000	2,640	0.04	0.36	8,900	1,140	0.021	0.291	8,700	1,110	0.022	0.216	8,400	1,080	0.021	0.21		
			6	13,300	2,500	0.038	0.36	8,600	1,110	0.02	0.277	8,400	1,080	0.021	0.206	8,200	1,050	0.02	0.2		
			8	11,800	2,200	0.035	0.35	8,400	1,080	0.019	0.263	8,100	1,050	0.02	0.196	7,900	1,020	0.019	0.19		
			10	10,500	2,090	0.03	0.35	8,100	1,050	0.018	0.249	7,900	1,020	0.019	0.185	7,700	990	0.018	0.18		
			12	10,000	1,950	0.026	0.335	7,900	1,010	0.017	0.235	7,700	990	0.018	0.175	7,500	960	0.017	0.17		
			16	8,800	1,600	0.02	0.315	7,400	950	0.015	0.208	7,200	930	0.015	0.155	7,000	900	0.015	0.15		
		R0.2 R0.3 R0.5 R1	4	14,000	2,640	0.08	0.72	8,900	1,140	0.04	1.45	8,700	1,110	0.04	0.87	8,400	1,080	0.04	0.84		
			6	13,300	2,500	0.08	0.72	8,600	1,110	0.04	1.38	8,400	1,080	0.04	0.82	8,200	1,050	0.04	0.8		
			8	11,800	2,200	0.07	0.7	8,400	1,080	0.04	1.31	8,100	1,050	0.04	0.78	7,900	1,020	0.04	0.76		
			10	10,500	2,090	0.06	0.7	8,100	1,050	0.04	1.25	7,900	1,020	0.04	0.74	7,700	990	0.04	0.72		
			12	10,000	1,950	0.05	0.67	7,900	1,010	0.03	1.18	7,700	990	0.04	0.7	7,500	960	0.03	0.68		
			16	8,800	1,600	0.04	0.63	7,400	950	0.03	1	7,200	930	0.03	0.62	7,000	900	0.03	0.6		
		4040	4	R0.05	8	8,500	1,420	0.026	0.338	6,200	1,130	0.013	0.016	6,100	1,090	0.013	0.015	5,900	1,060	0.013	0.014
					12	7,600	1,390	0.023	0.288	5,900	1,080	0.012	0.014	5,800	1,040	0.012	0.014	5,600	1,010	0.012	0.013
					16	6,600	1,330	0.018	0.25	5,700	1,030	0.011	0.013	5,600	1,000	0.011	0.013	5,400	970	0.011	0.012
					20	5,800	1,260	0.015	0.225	5,400	980	0.01	0.012	5,300	950	0.01	0.011	5,100	920	0.01	0.011
				R0.1	8	8,500	1,420	0.052	0.675	6,200	1,130	0.026	0.36	6,100	1,090	0.027	0.268	5,900	1,060	0.026	0.26
					12	7,600	1,390	0.046	0.575	5,900	1,080	0.024	0.332	5,800	1,040	0.025	0.247	5,600	1,010	0.024	0.24
16	6,600				1,330	0.036	0.5	5,700	1,030	0.022	0.304	5,600	1,000	0.023	0.227	5,400	970	0.022	0.22		
20	5,800				1,260	0.03	0.45	5,400	980	0.02	0.277	5,300	950	0.021	0.206	5,100	920	0.02	0.2		
R0.2 R0.3 R0.5 R1	8			8,500	1,420	0.1	1.35	6,200	1,130	0.05	1.8	6,100	1,090	0.05	1.07	5,900	1,060	0.05	1.04		
	12			7,600	1,390	0.09	1.15	5,900	1,080	0.05	1.66	5,800	1,040	0.05	0.99	5,600	1,010	0.05	0.96		
	16			6,600	1,330	0.07	1	5,700	1,030	0.04	1.52	5,600	1,000	0.05	0.91	5,400	970	0.04	0.88		
	20			5,800	1,260	0.06	0.9	5,400	980	0.04	1.38	5,300	950	0.04	0.82	5,100	920	0.04	0.8		
4060	6	R0.1	12	4,700	1,360	0.1	0.675	3,900	1,180	0.033	0.676	3,800	1,150	0.033	0.502	3,700	1,120	0.033	0.488		
			16	4,000	1,150	0.095	0.665	3,800	1,150	0.031	0.641	3,700	1,110	0.032	0.476	3,600	1,080	0.031	0.463		
			20	3,500	1,000	0.09	0.655	3,700	1,120	0.029	0.607	3,600	1,080	0.03	0.451	3,500	1,050	0.029	0.438		
			24	3,100	860	0.085	0.645	3,600	1,080	0.028	0.572	3,500	1,050	0.028	0.425	3,400	1,020	0.028	0.413		
			30	2,600	740	0.079	0.63	3,400	1,030	0.025	0.52	3,300	1,000	0.026	0.386	3,200	970	0.025	0.375		
		R0.2 R0.3 R0.5 R1	12	4,700	1,360	0.2	1.35	3,900	1,180	0.07	3.38	3,800	1,150	0.07	2	3,700	1,120	0.07	1.95		
			16	4,000	1,150	0.19	1.33	3,800	1,150	0.06	3.21	3,700	1,110	0.06	1.9	3,600	1,080	0.06	1.85		
			20	3,500	1,000	0.18	1.31	3,700	1,120	0.06	3	3,600	1,080	0.06	1.8	3,500	1,050	0.06	1.75		
			24	3,100	860	0.17	1.29	3,600	1,080	0.06	2.86	3,500	1,050	0.06	1.7	3,400	1,020	0.06	1.65		
			30	2,600	740	0.16	1.26	3,400	1,030	0.05	2.6	3,300	1,000	0.05	1.55	3,200	970	0.05	1.5		

- Note:
- Decrease the feed rate more than 50% from the milling parameters when slot milling.
 - Decrease both spindle speed and feed rate proportionally when the milling parameters exceed the machine's maximum spindle speed, or when chattering and red-hot occur.
 - Every coolant offers stable milling.

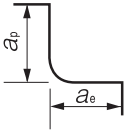

4 Flutes

∅3mm Shank
V Series

UDC-PCD
Series

CBN
Series

Square

Square

Long Neck
Square

Radius

Radius

Long Neck
Radius

Taper Neck
Radius

Ball

Ball / Long
Shank Ball

Long Neck
Ball

Taper Neck
Ball

Taper

Taper

Barrel

Spiral
V Cutter

Drill

Technical Data



Size $\phi 0.2 \sim \phi 6$

HLRS4000



Material Applications (★ Highly Recommended ● Recommended ○ Suggested)

Work Material																	
Carbon Steels S45C S55C	Alloy Steels SK / SCM SUS	Prehardened Steels NAK HPM	Hardened Steels					Cast Iron	Aluminum Alloys	Graphite	Copper	Plastics	Glass Filled Plastics	Titanium Alloys	Heat Resistant Alloys	Cemented Carbide	Hard Brittle (Non-Metallic) Materials
			~50HRC	~55HRC	~60HRC	~65HRC	~70HRC										
○	○	●	●	●	●	○								○	○		

Total 381 models

Unit (mm)

Model Number	Outside Diameter ϕD	Corner Radius CR	Effective Length ℓ_1	Length of Cut ℓ	Neck Diameter ϕd_1	Shank Taper Angle Bta	Overall Length L	Shank Diameter ϕd	Suggested Retail Price ¥
HLRS 4002-002-003	0.2	R0.02	0.3	0.12	0.185	16°	50	4	14,100
HLRS 4002-002-005			0.5				50	4	14,100
HLRS 4002-002-010			1				50	4	14,100
HLRS 4002-002-015			1.5				50	4	16,590
HLRS 4002-002-020			2				50	4	18,150
HLRS 4002-005-003			R0.05				0.3	50	4
HLRS 4003-002-003	0.3	R0.02	0.3	0.18	0.28	16°	50	4	14,100
HLRS 4003-002-005			0.5				50	4	14,100
HLRS 4003-002-010			1				50	4	14,100
HLRS 4003-002-015			1.5				50	4	14,100
HLRS 4003-002-020			2				50	4	14,100
HLRS 4003-005-003			R0.05				0.3	50	4
HLRS 4003-005-005		0.5	50	4	14,100				
HLRS 4004-002-005	0.4	R0.02	0.5	0.24	0.385	16°	50	4	9,050
HLRS 4004-002-010			1				50	4	9,050
HLRS 4004-002-020			2				50	4	9,050
HLRS 4004-005-005		R0.05	0.5				50	4	9,050
HLRS 4004-005-010			1				50	4	9,050
HLRS 4004-005-015			1.5				50	4	9,050
HLRS 4004-005-020			2				50	4	9,050
HLRS 4004-01-010		R0.1	1				50	4	9,050
HLRS 4004-01-020			2				50	4	9,050

Next Page →

Features

Long Neck Radius design for high efficiency and high quality milling.
 The rigid tool geometry offers longer tool life when milling Hard Materials.
 HARDMAX coat is adopted which maintains heat resistance, toughness and lubricity at a high level.
 Both dry and wet coolant offer stable and long tool life.
 Refer to page 324 for 2 flute HLRS.

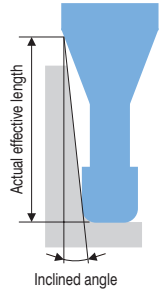

4 Flutes

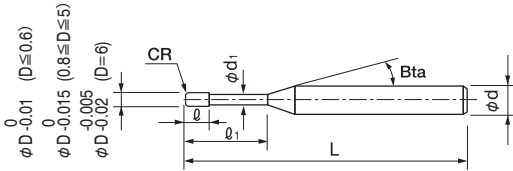

The shank taper angle shown is not an exact value and to avoid contact with the work piece, we recommend the user controls the precise value of this angle. Shank taper angle should not make contact with the work piece.

Unit (mm)

Model Number	Outside Diameter ϕD	Corner Radius CR	Effective Length l_1	Effective Length by Inclined Angles					
				30'	1°	1°30'	2°	3°	
HLRS 4002-002-003	0.2	RO.02	0.3	0.39	0.41	0.44	0.46	0.51	
HLRS 4002-002-005			0.5	0.60	0.63	0.67	0.70	0.75	
HLRS 4002-002-010			1	1.13	1.18	1.22	1.27	1.36	
HLRS 4002-002-015			1.5	1.65	1.71	1.77	1.84	1.98	
HLRS 4002-002-020			2	2.17	2.25	2.32	2.41	2.59	
HLRS 4002-005-003	0.3	RO.05	0.3	0.39	0.41	0.43	0.46	0.50	
HLRS 4003-002-003			0.3	0.41	0.43	0.46	0.48	0.52	
HLRS 4003-002-005		RO.02	0.5	0.62	0.65	0.68	0.71	0.77	
HLRS 4003-002-010			1	1.15	1.19	1.24	1.28	1.38	
HLRS 4003-002-015			1.5	1.67	1.73	1.79	1.85	1.99	
HLRS 4003-002-020			2	2.19	2.26	2.34	2.42	2.60	
HLRS 4003-005-003		RO.05	0.3	0.41	0.43	0.45	0.47	0.52	
HLRS 4003-005-005			0.5	0.62	0.65	0.68	0.71	0.76	
HLRS 4004-002-005		0.4	RO.02	0.5	0.62	0.65	0.68	0.71	0.77
HLRS 4004-002-010				1	1.15	1.19	1.24	1.28	1.38
HLRS 4004-002-020	2			2.17	2.25	2.33	2.41	2.59	
HLRS 4004-005-005	RO.05		0.5	0.62	0.65	0.68	0.71	0.76	
HLRS 4004-005-010			1	1.14	1.19	1.23	1.28	1.37	
HLRS 4004-005-015			1.5	1.65	1.72	1.77	1.84	1.97	
HLRS 4004-005-020			2	2.17	2.25	2.32	2.41	2.59	
HLRS 4004-01-010	RO.1		1	1.14	1.19	1.23	1.27	1.36	
HLRS 4004-01-020			2	2.17	2.25	2.32	2.40	2.57	

- $\phi 3$ mm Shank V Series
- UDC-PCD Series
- CBN Series
- Square
- Long Neck Square
- Radius
- Long Neck Radius
- Taper Neck Radius
- Ball / Long Shank Ball
- Long Neck Ball
- Taper Neck Ball
- Taper
- Barrel
- Spiral V Cutter
- Drill
- Technical Data

Next Page →

Unit (mm)

Model Number	Outside Diameter ϕD	Corner Radius CR	Effective Length ℓ_1	Length of Cut ℓ	Neck Diameter ϕd_1	Shank Taper Angle Bta	Overall Length L	Shank Diameter ϕd	Suggested Retail Price ¥	
HLRS 4005-002-010	0.5	R0.02	1	0.3	0.485	16°	50	4	7,370	
HLRS 4005-002-020			2				50	4	7,370	
HLRS 4005-005-010		R0.05	1				50	4	7,370	
HLRS 4005-005-020			2				50	4	7,370	
HLRS 4005-01-010		R0.1	1				50	4	7,370	
HLRS 4005-01-020			2				50	4	7,370	
HLRS 4006-005-020	0.6	R0.05	2	0.36	0.585	16°	50	4	7,370	
HLRS 4006-005-040			4				50	4	7,370	
HLRS 4006-01-020		R0.1	2				50	4	7,370	
HLRS 4006-01-040			4				50	4	7,370	
HLRS 4008-002-020	0.8	R0.02	2	0.48	0.78	16°	50	4	8,100	
HLRS 4008-002-030			3				50	4	8,100	
HLRS 4008-002-040			4				50	4	8,400	
HLRS 4008-002-060			6				50	4	8,400	
HLRS 4008-002-080			8				50	4	8,400	
HLRS 4008-005-020			R0.05				2	50	4	8,100
HLRS 4008-005-030		3					50	4	8,100	
HLRS 4008-005-040		4					50	4	8,400	
HLRS 4008-005-060		6					50	4	8,400	
HLRS 4008-01-020		R0.1					2	50	4	8,100
HLRS 4008-01-030							3	50	4	8,100
HLRS 4008-01-040			4				50	4	8,400	
HLRS 4008-01-060			6				50	4	8,400	
HLRS 4008-02-020			R0.2				2	50	4	8,100
HLRS 4008-02-030							3	50	4	8,100
HLRS 4008-02-040		4					50	4	8,400	
HLRS 4008-02-060		6					50	4	8,400	
HLRS 4010-002-020		1					R0.02	2	0.8	0.95
HLRS 4010-002-030	3			50	4	7,400				
HLRS 4010-002-040	4		50	4	7,400					
HLRS 4010-002-050	5		50	4	8,100					
HLRS 4010-002-060	6		50	4	8,100					
HLRS 4010-002-080	8		50	4	8,100					
HLRS 4010-002-100	10		50	4	8,100					
HLRS 4010-002-120	12		55	4	8,100					
HLRS 4010-005-020	R0.05		2	50	4	7,400				
HLRS 4010-005-030			3	50	4	7,400				
HLRS 4010-005-040			4	50	4	7,400				

- 3mm Shank V Series
- UDC-PCD Series
- CBN Series
- Square
- Long Neck Square
- Radius
- Long Neck Radius
- Taper Neck Radius
- Ball / Long Shank Ball
- Long Neck Ball
- Taper Neck Ball
- Taper
- Barrel
- Spiral V Cutter
- Drill
- Technical Data

Model Number	Outside Diameter ϕD	Corner Radius CR	Effective Length l_1	Effective Length by Inclined Angles				
				30'	1°	1°30'	2°	3°
HLRS 4005-002-010	0.5	RO.02	1	1.15	1.19	1.24	1.28	1.38
HLRS 4005-002-020			2	2.17	2.25	2.33	2.41	2.59
HLRS 4005-005-010		RO.05	1	1.14	1.19	1.23	1.28	1.37
HLRS 4005-005-020			2	2.17	2.25	2.32	2.41	2.59
HLRS 4005-01-010		RO.1	1	1.14	1.19	1.23	1.27	1.36
HLRS 4005-01-020			2	2.17	2.25	2.32	2.40	2.57
HLRS 4006-005-020	0.6	RO.05	2	2.17	2.25	2.32	2.41	2.59
HLRS 4006-005-040			4	4.24	4.38	4.53	4.68	5.03
HLRS 4006-01-020		RO.1	2	2.17	2.25	2.32	2.40	2.57
HLRS 4006-01-040			4	4.24	4.38	4.52	4.68	5.02
HLRS 4008-002-020	0.8	RO.02	2	2.51	2.70	2.87	3.02	3.29
HLRS 4008-002-030			3	3.59	3.82	4.02	4.19	4.51
HLRS 4008-002-040			4	4.66	4.92	5.14	5.34	5.74
HLRS 4008-002-060			6	6.78	7.10	7.36	7.61	8.19
HLRS 4008-002-080		8	8.88	9.25	9.56	9.89	10.63	
HLRS 4008-005-020		RO.05	2	2.51	2.70	2.86	3.01	3.28
HLRS 4008-005-030			3	3.59	3.82	4.01	4.19	4.51
HLRS 4008-005-040			4	4.66	4.92	5.14	5.33	5.73
HLRS 4008-005-060		RO.1	6	6.77	7.09	7.35	7.61	8.18
HLRS 4008-01-020			2	2.51	2.69	2.86	3.00	3.27
HLRS 4008-01-030			3	3.58	3.81	4.01	4.18	4.50
HLRS 4008-01-040			4	4.65	4.92	5.13	5.33	5.72
HLRS 4008-01-060			6	6.77	7.09	7.35	7.60	8.17
HLRS 4008-02-020			RO.2	2	2.49	2.68	2.84	2.98
HLRS 4008-02-030		3		3.57	3.80	3.99	4.16	4.47
HLRS 4008-02-040		4		4.64	4.90	5.12	5.31	5.70
HLRS 4008-02-060		6		6.76	7.08	7.34	7.59	8.14
HLRS 4010-002-020		1	RO.02	2	2.57	2.75	2.90	3.05
HLRS 4010-002-030	3			3.64	3.86	4.05	4.22	4.54
HLRS 4010-002-040	4			4.70	4.96	5.17	5.36	5.76
HLRS 4010-002-050	5			5.76	6.04	6.28	6.50	6.99
HLRS 4010-002-060	6			6.81	7.12	7.38	7.64	8.21
HLRS 4010-002-080	8			8.91	9.27	9.58	9.92	10.66
HLRS 4010-002-100	10			11.00	11.40	11.78	12.19	13.11
HLRS 4010-002-120	12			13.08	13.53	13.98	14.47	15.55
HLRS 4010-005-020	RO.05		2	2.56	2.74	2.90	3.05	3.31
HLRS 4010-005-030			3	3.63	3.85	4.04	4.21	4.53
HLRS 4010-005-040			4	4.70	4.95	5.17	5.36	5.76

4 Flutes

Ø3mm Shank
V SeriesUDC-PCD
SeriesCBN
Series

Square

Square

Long Neck
Square

Radius

Radius

Long Neck
RadiusTaper Neck
RadiusBall / Long
Shank Ball

Ball

Long Neck
BallTaper Neck
Ball

Taper

Taper

Barrel

Spiral
V Cutter

Drill

Technical Data

Unit (mm)

Model Number	Outside Diameter ϕD	Corner Radius CR	Effective Length ℓ_1	Length of Cut ℓ	Neck Diameter ϕd_1	Shank Taper Angle Bta	Overall Length L	Shank Diameter ϕd	Suggested Retail Price ¥	
HLRS 4010-005-050	1	RO.05	5	0.8	0.95	16°	50	4	8,100	
HLRS 4010-005-060			6				50	4	8,100	
HLRS 4010-005-080			8				50	4	8,100	
HLRS 4010-005-100			10				50	4	8,100	
HLRS 4010-005-120			12				55	4	8,100	
HLRS 4010-01-020		RO.1	2				50	4	7,400	
HLRS 4010-01-030			3				50	4	7,400	
HLRS 4010-01-040			4				50	4	7,400	
HLRS 4010-01-050			5				50	4	8,100	
HLRS 4010-01-060			6				50	4	8,100	
HLRS 4010-01-080			8				50	4	8,100	
HLRS 4010-01-100			10				50	4	8,100	
HLRS 4010-01-120			12				55	4	8,100	
HLRS 4010-02-020			RO.2				2	50	4	7,400
HLRS 4010-02-030							3	50	4	7,400
HLRS 4010-02-040							4	50	4	7,400
HLRS 4010-02-050							5	50	4	8,100
HLRS 4010-02-060		6					50	4	8,100	
HLRS 4010-02-080		8					50	4	8,100	
HLRS 4010-02-100		10					50	4	8,100	
HLRS 4010-02-120		12					55	4	8,100	
HLRS 4010-03-020		RO.3					2	50	4	7,400
HLRS 4010-03-030							3	50	4	7,400
HLRS 4010-03-040							4	50	4	7,400
HLRS 4010-03-050							5	50	4	8,100
HLRS 4010-03-060			6				50	4	8,100	
HLRS 4010-03-080			8				50	4	8,100	
HLRS 4010-03-100			10				50	4	8,100	
HLRS 4010-03-120	12		55	4	8,100					
HLRS 4010-03-160	16		60	4	10,740					
HLRS 4012-01-040	1.2		RO.1	4	0.96	1.14	16°	50	4	8,400
HLRS 4012-01-060				6				50	4	8,400
HLRS 4012-01-100				10				50	4	8,400
HLRS 4012-02-040		RO.2	4	50				4	8,400	
HLRS 4012-02-060			6	50				4	8,400	
HLRS 4012-02-100			10	50				4	8,400	
HLRS 4012-03-040		RO.3	4	50				4	8,400	
HLRS 4012-03-060			6	50				4	8,400	
HLRS 4012-03-100			10	50				4	8,400	

- $\phi 3$ mm Shank V Series
- UDC-PCD Series
- CBN Series
- Square
- Long Neck Square
- Radius
- Long Neck Radius
- Taper Neck Radius
- Ball / Long Shank Ball
- Long Neck Ball
- Taper Neck Ball
- Taper
- Barrel
- Spiral V Cutter
- Drill
- Technical Data

Model Number	Outside Diameter ϕD	Corner Radius CR	Effective Length l_1	Effective Length by Inclined Angles					
				30'	1°	1°30'	2°	3°	
HLRS 4010-005-050	1	RO.05	5	5.76	6.04	6.28	6.50	6.98	
HLRS 4010-005-060			6	6.81	7.12	7.38	7.63	8.20	
HLRS 4010-005-080			8	8.91	9.27	9.58	9.91	10.65	
HLRS 4010-005-100			10	11.00	11.40	11.78	12.19	13.10	
HLRS 4010-005-120			12	13.08	13.53	13.98	14.47	15.55	
HLRS 4010-01-020		RO.1	2	2.56	2.74	2.89	3.04	3.30	
HLRS 4010-01-030			3	3.63	3.85	4.04	4.20	4.52	
HLRS 4010-01-040			4	4.70	4.95	5.16	5.35	5.75	
HLRS 4010-01-050			5	5.75	6.04	6.27	6.49	6.97	
HLRS 4010-01-060			6	6.81	7.12	7.37	7.63	8.19	
HLRS 4010-01-080			8	8.91	9.26	9.57	9.90	10.64	
HLRS 4010-01-100			10	11.00	11.39	11.77	12.18	13.09	
HLRS 4010-01-120		12	13.08	13.52	13.98	14.46	15.54		
HLRS 4010-02-020		RO.2	2	2.55	2.72	2.88	3.02	3.28	
HLRS 4010-02-030			3	3.62	3.84	4.02	4.19	4.50	
HLRS 4010-02-040			4	4.69	4.94	5.15	5.34	5.72	
HLRS 4010-02-050			5	5.75	6.03	6.26	6.47	6.95	
HLRS 4010-02-060			6	6.80	7.11	7.36	7.61	8.17	
HLRS 4010-02-080			8	8.90	9.26	9.56	9.89	10.62	
HLRS 4010-02-100			10	10.99	11.39	11.76	12.17	13.07	
HLRS 4010-02-120		12	13.07	13.52	13.97	14.45	15.51		
HLRS 4010-03-020		RO.3	2	2.54	2.71	2.86	3.00	3.25	
HLRS 4010-03-030			3	3.62	3.83	4.01	4.17	4.48	
HLRS 4010-03-040			4	4.68	4.93	5.14	5.32	5.70	
HLRS 4010-03-050			5	5.74	6.02	6.25	6.46	6.93	
HLRS 4010-03-060			6	6.80	7.10	7.35	7.60	8.15	
HLRS 4010-03-080			8	8.90	9.25	9.55	9.88	10.60	
HLRS 4010-03-100			10	10.99	11.38	11.75	12.15	13.04	
HLRS 4010-03-120		12	13.07	13.51	13.96	14.43	15.49		
HLRS 4010-03-160		16	17.22	17.77	18.36	18.99	20.39		
HLRS 4012-01-040		1.2	RO.1	4	4.13	4.27	4.41	4.56	4.90
HLRS 4012-01-060				6	6.20	6.40	6.61	6.84	7.34
HLRS 4012-01-100				10	10.32	10.66	11.01	11.39	12.24
HLRS 4012-02-040			RO.2	4	4.13	4.26	4.40	4.55	4.87
HLRS 4012-02-060				6	6.19	6.39	6.60	6.82	7.32
HLRS 4012-02-100				10	10.32	10.65	11.00	11.38	12.22
HLRS 4012-03-040	RO.3		4	4.13	4.25	4.39	4.53	4.85	
HLRS 4012-03-060			6	6.19	6.38	6.59	6.81	7.30	
HLRS 4012-03-100			10	10.32	10.64	10.99	11.36	12.20	

4 Flutes

 $\phi 3$ mm Shank
V SeriesUDC-PCD
SeriesCBN
SeriesSquare
Long Neck
SquareRadius
Long Neck
RadiusTaper Neck
RadiusBall / Long
Shank BallLong Neck
BallTaper Neck
Ball

Taper

Barrel

Spiral
V Cutter

Drill

Technical Data

Unit (mm)

Model Number	Outside Diameter ϕD	Corner Radius CR	Effective Length ℓ_1	Length of Cut ℓ	Neck Diameter ϕd_1	Shank Taper Angle β	Overall Length L	Shank Diameter ϕd	Suggested Retail Price ¥	
HLRS 4015-005-030	1.5	RO.05	3	1.2	1.45	16°	50	4	7,900	
HLRS 4015-005-040			4				50	4	7,900	
HLRS 4015-005-060			6				50	4	7,900	
HLRS 4015-005-080			8				50	4	8,200	
HLRS 4015-005-120			12				55	4	8,200	
HLRS 4015-005-160			16				60	4	8,200	
HLRS 4015-01-030		RO.1	3				50	4	7,900	
HLRS 4015-01-040			4				50	4	7,900	
HLRS 4015-01-060			6				50	4	7,900	
HLRS 4015-01-080			8				50	4	8,200	
HLRS 4015-01-100			10				50	4	8,200	
HLRS 4015-01-120			12				55	4	8,200	
HLRS 4015-01-160			16				60	4	8,200	
HLRS 4015-01-180			18				60	4	8,200	
HLRS 4015-02-030			RO.2				3	50	4	7,900
HLRS 4015-02-040							4	50	4	7,900
HLRS 4015-02-060							6	50	4	7,900
HLRS 4015-02-080							8	50	4	8,200
HLRS 4015-02-100							10	50	4	8,200
HLRS 4015-02-120							12	55	4	8,200
HLRS 4015-02-160			16				60	4	8,200	
HLRS 4015-02-180			18				60	4	8,200	
HLRS 4015-03-030			RO.3				3	50	4	7,900
HLRS 4015-03-040							4	50	4	7,900
HLRS 4015-03-060		6					50	4	7,900	
HLRS 4015-03-080		8					50	4	8,200	
HLRS 4015-03-100		10					50	4	8,200	
HLRS 4015-03-120		12					55	4	8,200	
HLRS 4015-03-160		16	60				4	8,200		
HLRS 4015-03-180		18	60				4	8,200		
HLRS 4015-05-030	RO.5	3	50	4	7,900					
HLRS 4015-05-040		4	50	4	7,900					
HLRS 4015-05-060		6	50	4	7,900					
HLRS 4015-05-080		8	50	4	8,200					
HLRS 4015-05-100		10	50	4	8,200					
HLRS 4015-05-120		12	55	4	8,200					
HLRS 4015-05-160	16	60	4	8,200						
HLRS 4015-05-180	18	60	4	8,200						

$\phi 3$ mm Shank V Series

UDC-PCD Series

CBN Series

Square
Long Neck Square

Radius

Radius
Long Neck Radius
Taper Neck Radius

Ball / Long Shank Ball

Ball
Long Neck Ball
Taper Neck Ball

Taper

Barrel

Spiral V Cutter

Drill

Technical Data

Model Number	Outside Diameter ϕD	Corner Radius CR	Effective Length l_1	Effective Length by Inclined Angles				
				30'	1°	1°30'	2°	3°
HLRS 4015-005-030	1.5	RO.05	3	3.10	3.20	3.31	3.43	3.68
HLRS 4015-005-040			4	4.14	4.27	4.41	4.57	4.91
HLRS 4015-005-060			6	6.20	6.40	6.61	6.84	7.35
HLRS 4015-005-080			8	8.26	8.53	8.82	9.12	9.80
HLRS 4015-005-120			12	12.39	12.79	13.22	13.68	14.70
HLRS 4015-005-160			16	16.51	17.05	17.62	18.23	19.59
HLRS 4015-01-030		RO.1	3	3.10	3.20	3.31	3.42	3.67
HLRS 4015-01-040			4	4.13	4.27	4.41	4.56	4.90
HLRS 4015-01-060			6	6.20	6.40	6.61	6.84	7.34
HLRS 4015-01-080			8	8.26	8.53	8.81	9.11	9.79
HLRS 4015-01-100			10	10.32	10.66	11.01	11.39	12.24
HLRS 4015-01-120			12	12.39	12.79	13.21	13.67	14.69
HLRS 4015-01-160		RO.2	16	16.51	17.04	17.61	18.22	19.58
HLRS 4015-01-180			18	18.57	19.17	19.82	20.50	22.03
HLRS 4015-02-030			3	3.10	3.20	3.30	3.41	3.65
HLRS 4015-02-040			4	4.13	4.26	4.40	4.55	4.87
HLRS 4015-02-060			6	6.19	6.39	6.60	6.82	7.32
HLRS 4015-02-080			8	8.26	8.52	8.80	9.10	9.77
HLRS 4015-02-100		RO.3	10	10.32	10.65	11.00	11.38	12.22
HLRS 4015-02-120			12	12.38	12.78	13.20	13.66	14.66
HLRS 4015-02-160			16	16.51	17.04	17.60	18.21	19.56
HLRS 4015-02-180			18	18.57	19.17	19.81	20.49	22.01
HLRS 4015-03-030			3	3.10	3.19	3.29	3.39	3.63
HLRS 4015-03-040			4	4.13	4.25	4.39	4.53	4.85
HLRS 4015-03-060		RO.5	6	6.19	6.38	6.59	6.81	7.30
HLRS 4015-03-080			8	8.25	8.51	8.79	9.09	9.75
HLRS 4015-03-100			10	10.32	10.64	10.99	11.36	12.20
HLRS 4015-03-120			12	12.38	12.77	13.19	13.64	14.64
HLRS 4015-03-160			16	16.50	17.03	17.59	18.20	19.54
HLRS 4015-03-180			18	18.57	19.16	19.80	20.47	21.98
HLRS 4015-05-030		RO.5	3	3.09	3.17	3.27	3.36	3.58
HLRS 4015-05-040			4	4.12	4.24	4.37	4.50	4.81
HLRS 4015-05-060			6	6.18	6.37	6.57	6.78	7.25
HLRS 4015-05-080			8	8.25	8.50	8.77	9.06	9.70
HLRS 4015-05-100			10	10.31	10.63	10.97	11.34	12.15
HLRS 4015-05-120			12	12.37	12.76	13.17	13.61	14.60
HLRS 4015-05-160			16	16.50	17.02	17.57	18.17	19.49
HLRS 4015-05-180			18	18.56	19.15	19.77	20.44	21.94

4 Flutes

 $\phi 3$ mm Shank
V SeriesUDC-PCD
SeriesCBN
Series

Square

Square
Long Neck
Square

Radius

Radius
Long Neck
RadiusTaper Neck
RadiusBall / Long
Shank BallBall
Long Neck
BallTaper Neck
Ball

Taper

Taper
Taper

Barrel

Spiral
V Cutter

Drill

Technical Data

Unit (mm)

Model Number	Outside Diameter ϕD	Corner Radius CR	Effective Length ℓ_1	Length of Cut ℓ	Neck Diameter ϕd_1	Shank Taper Angle Bta	Overall Length L	Shank Diameter ϕd	Suggested Retail Price ¥	
HLRS 4018-02-080	1.8	RO.2	8	1.44	1.72	16°	50	4	8,200	
HLRS 4018-02-100			10				50	4	8,200	
HLRS 4018-02-120			12				55	4	8,200	
HLRS 4018-02-140			14				55	4	8,200	
HLRS 4018-02-160			16				60	4	8,200	
HLRS 4020-002-040	2	RO.02	4	1.6	1.92	16°	50	4	7,900	
HLRS 4020-002-060			6				50	4	7,900	
HLRS 4020-002-080			8				50	4	8,200	
HLRS 4020-002-100			10				50	4	8,200	
HLRS 4020-002-120			12				55	4	8,200	
HLRS 4020-002-160			16				60	4	8,200	
HLRS 4020-002-200			20				60	4	8,200	
HLRS 4020-005-040			RO.05				4	50	4	7,900
HLRS 4020-005-060							6	50	4	7,900
HLRS 4020-005-080							8	50	4	8,200
HLRS 4020-005-100		10					50	4	8,200	
HLRS 4020-005-120		12					55	4	8,200	
HLRS 4020-005-160		16					60	4	8,200	
HLRS 4020-005-200		20					60	4	8,200	
HLRS 4020-01-040		RO.1					4	50	4	7,900
HLRS 4020-01-060							6	50	4	7,900
HLRS 4020-01-080							8	50	4	8,200
HLRS 4020-01-100			10				50	4	8,200	
HLRS 4020-01-120			12				55	4	8,200	
HLRS 4020-01-160			16				60	4	8,200	
HLRS 4020-01-200			20				60	4	8,200	
HLRS 4020-01-240			24				70	4	8,200	
HLRS 4020-02-040			RO.2				4	50	4	7,900
HLRS 4020-02-060							6	50	4	7,900
HLRS 4020-02-080		8					50	4	8,200	
HLRS 4020-02-100		10					50	4	8,200	
HLRS 4020-02-120		12					55	4	8,200	
HLRS 4020-02-160		16					60	4	8,200	
HLRS 4020-02-200		20					60	4	8,200	
HLRS 4020-02-240		24					70	4	8,200	
HLRS 4020-03-040	RO.3	4		50	4	7,900				
HLRS 4020-03-060		6		50	4	7,900				
HLRS 4020-03-080		8	50	4	8,200					
HLRS 4020-03-100		10	50	4	8,200					
HLRS 4020-03-120		12	55	4	8,200					
HLRS 4020-03-160		16	60	4	8,200					
HLRS 4020-03-200		20	60	4	8,200					
HLRS 4020-03-240	24	70	4	8,200						

- φ3mm Shank V Series
- UDC-PCD Series
- CBN Series
- Square
- Long Neck Square
- Radius
- Long Neck Radius
- Taper Neck Radius
- Ball / Long Shank Ball
- Long Neck Ball
- Taper Neck Ball
- Taper
- Barrel
- Spiral V Cutter
- Drill
- Technical Data

Model Number	Outside Diameter ϕD	Corner Radius CR	Effective Length l_1	Effective Length by Inclined Angles					
				30'	1°	1°30'	2°	3°	
HLRS 4018-02-080	1.8	RO.2	8	8.29	8.56	8.84	9.14	9.81	
HLRS 4018-02-100			10	10.36	10.69	11.04	11.42	12.26	
HLRS 4018-02-120			12	12.42	12.82	13.24	13.69	14.71	
HLRS 4018-02-140			14	14.48	14.95	15.44	15.97	17.15	
HLRS 4018-02-160			16	16.54	17.08	17.64	18.25	19.60	
HLRS 4020-002-040	2	RO.02	4	4.17	4.31	4.45	4.61	4.96	
HLRS 4020-002-060			6	6.24	6.44	6.66	6.89	7.40	
HLRS 4020-002-080			8	8.30	8.57	8.86	9.16	9.85	
HLRS 4020-002-100			10	10.36	10.70	11.06	11.44	12.30	
HLRS 4020-002-120			12	12.42	12.83	13.26	13.72	14.75	
HLRS 4020-002-160		16	16.55	17.09	17.66	18.27	No Interference		
HLRS 4020-002-200		20	20.67	21.35	22.06	22.83	No Interference		
HLRS 4020-005-040		RO.05	4	4.17	4.31	4.45	4.61	4.95	
HLRS 4020-005-060			6	6.23	6.44	6.65	6.88	7.40	
HLRS 4020-005-080			8	8.30	8.57	8.85	9.16	9.84	
HLRS 4020-005-100	10		10.36	10.70	11.05	11.44	12.29		
HLRS 4020-005-120	12		12.42	12.83	13.26	13.72	14.74		
HLRS 4020-005-160	16	16.55	17.08	17.66	18.27	No Interference			
HLRS 4020-005-200	20	20.67	21.34	22.06	22.82	No Interference			
HLRS 4020-01-040	2	RO.1	4	4.17	4.30	4.45	4.60	4.94	
HLRS 4020-01-060			6	6.23	6.43	6.65	6.88	7.39	
HLRS 4020-01-080			8	8.30	8.56	8.85	9.15	9.83	
HLRS 4020-01-100			10	10.36	10.69	11.05	11.43	12.28	
HLRS 4020-01-120			12	12.42	12.82	13.25	13.71	14.73	
HLRS 4020-01-160		16	16.55	17.08	17.65	18.26	No Interference		
HLRS 4020-01-200		20	20.67	21.34	22.05	22.82	No Interference		
HLRS 4020-01-240		24	24.80	25.60	26.46	27.37	No Interference		
HLRS 4020-02-040		2	RO.2	4	4.17	4.30	4.44	4.59	4.92
HLRS 4020-02-060				6	6.23	6.43	6.64	6.86	7.36
HLRS 4020-02-080	8			8.29	8.56	8.84	9.14	9.81	
HLRS 4020-02-100	10			10.36	10.69	11.04	11.42	12.26	
HLRS 4020-02-120	12			12.42	12.82	13.24	13.69	14.71	
HLRS 4020-02-160	16		16.54	17.08	17.64	18.25	19.60		
HLRS 4020-02-200	20		20.67	21.33	22.04	22.80	No Interference		
HLRS 4020-02-240	24		24.79	25.59	26.45	27.36	No Interference		
HLRS 4020-03-040	2	RO.3	4	4.16	4.29	4.43	4.57	4.90	
HLRS 4020-03-060			6	6.23	6.42	6.63	6.85	7.34	
HLRS 4020-03-080			8	8.29	8.55	8.83	9.13	9.79	
HLRS 4020-03-100			10	10.35	10.68	11.03	11.40	12.24	
HLRS 4020-03-120			12	12.41	12.81	13.23	13.68	14.68	
HLRS 4020-03-160			16	16.54	17.07	17.63	18.24	19.58	
HLRS 4020-03-200			20	20.67	21.33	22.03	22.79	No Interference	
HLRS 4020-03-240			24	24.79	25.59	26.44	27.35	No Interference	

4 Flutes

3mm Shank
V SeriesUDC-PCD
SeriesCBN
Series

Square

Square
Long Neck
Square

Radius

Radius
Long Neck
RadiusTaper Neck
RadiusBall / Long
Shank BallBall
Long Neck
BallTaper Neck
Ball

Taper

Barrel

Spiral
V Cutter

Drill

Technical Data

Unit (mm)

Model Number	Outside Diameter ϕD	Corner Radius CR	Effective Length ℓ_1	Length of Cut ℓ	Neck Diameter ϕd_1	Shank Taper Angle β	Overall Length L	Shank Diameter ϕd	Suggested Retail Price ¥
HLRS 4020-05-040	2	RO.5	4	1.6	1.92	16°	50	4	7,900
HLRS 4020-05-060			6				50	4	7,900
HLRS 4020-05-080			8				50	4	8,200
HLRS 4020-05-100			10				50	4	8,200
HLRS 4020-05-120			12				55	4	8,200
HLRS 4020-05-160			16				60	4	8,200
HLRS 4020-05-200			20				60	4	8,200
HLRS 4020-05-240			24				70	4	8,200
HLRS 4020-05-260			26				70	4	8,200
HLRS 4020-05-300			30				70	4	8,200
HLRS 4025-01-060	2.5	RO.1	6	2	2.42	16°	50	4	8,600
HLRS 4025-01-080			8				50	4	8,600
HLRS 4025-01-100			10				50	4	8,600
HLRS 4025-01-160			16				60	4	8,900
HLRS 4025-01-200			20				60	4	8,900
HLRS 4025-01-300			30				70	4	9,200
HLRS 4025-02-060		RO.2	6				50	4	8,600
HLRS 4025-02-080			8				50	4	8,600
HLRS 4025-02-100			10				50	4	8,600
HLRS 4025-02-160			16				60	4	8,900
HLRS 4025-02-200			20				60	4	8,900
HLRS 4025-02-300			30				70	4	9,200
HLRS 4025-03-060		RO.3	6				50	4	8,600
HLRS 4025-03-080			8				50	4	8,600
HLRS 4025-03-100			10				50	4	8,600
HLRS 4025-03-160			16				60	4	8,900
HLRS 4025-03-200			20				60	4	8,900
HLRS 4025-03-300			30				70	4	9,200
HLRS 4025-05-060		RO.5	6				50	4	8,600
HLRS 4025-05-080			8				50	4	8,600
HLRS 4025-05-100			10				50	4	8,600
HLRS 4025-05-160			16				60	4	8,900
HLRS 4025-05-200			20				60	4	8,900
HLRS 4025-05-300			30				70	4	9,200

- $\phi 3$ mm Shank V Series
- UDC-PCD Series
- CBN Series
- Square
- Long Neck Square
- Radius
- Long Neck Radius
- Taper Neck Radius
- Ball / Long Shank Ball
- Long Neck Ball
- Taper Neck Ball
- Taper
- Barrel
- Spiral V Cutter
- Drill
- Technical Data

Model Number	Outside Diameter ϕD	Corner Radius CR	Effective Length l_1	Effective Length by Inclined Angles				
				30'	1°	1°30'	2°	3°
HLRS 4020-05-040	2	RO.5	4	4.16	4.28	4.40	4.54	4.85
HLRS 4020-05-060			6	6.22	6.41	6.61	6.82	7.30
HLRS 4020-05-080			8	8.28	8.54	8.81	9.10	9.74
HLRS 4020-05-100			10	10.34	10.67	11.01	11.37	12.19
HLRS 4020-05-120			12	12.41	12.79	13.21	13.65	14.64
HLRS 4020-05-160			16	16.53	17.05	17.61	18.21	19.53
HLRS 4020-05-200			20	20.66	21.31	22.01	22.76	No Interference
HLRS 4020-05-240			24	24.78	25.57	26.41	27.32	No Interference
HLRS 4020-05-260			26	26.85	27.70	28.62	29.59	No Interference
HLRS 4020-05-300			30	30.97	31.96	33.02	No Interference	No Interference
HLRS 4025-01-060			2.5	RO.1	6	6.23	6.43	6.65
HLRS 4025-01-080	8	8.30			8.56	8.85	9.15	9.83
HLRS 4025-01-100	10	10.36			10.69	11.05	11.43	12.28
HLRS 4025-01-160	16	16.55			17.08	17.65	18.26	No Interference
HLRS 4025-01-200	20	20.67			21.34	22.05	No Interference	No Interference
HLRS 4025-01-300	30	30.99			31.99	No Interference	No Interference	No Interference
HLRS 4025-02-060	RO.2	6		6.23	6.43	6.64	6.86	7.36
HLRS 4025-02-080		8		8.29	8.56	8.84	9.14	9.81
HLRS 4025-02-100		10		10.36	10.69	11.04	11.42	12.26
HLRS 4025-02-160		16		16.54	17.08	17.64	18.25	No Interference
HLRS 4025-02-200		20		20.67	21.33	22.04	No Interference	No Interference
HLRS 4025-02-300		30		30.98	31.98	No Interference	No Interference	No Interference
HLRS 4025-03-060	RO.3	6		6.23	6.42	6.63	6.85	7.34
HLRS 4025-03-080		8		8.29	8.55	8.83	9.13	9.79
HLRS 4025-03-100		10		10.35	10.68	11.03	11.40	12.24
HLRS 4025-03-160		16		16.54	17.07	17.63	18.24	No Interference
HLRS 4025-03-200		20		20.67	21.33	22.03	No Interference	No Interference
HLRS 4025-03-300		30		30.98	31.98	No Interference	No Interference	No Interference
HLRS 4025-05-060	RO.5	6		6.22	6.41	6.61	6.82	7.30
HLRS 4025-05-080		8		8.28	8.54	8.81	9.10	9.74
HLRS 4025-05-100		10		10.34	10.67	11.01	11.37	12.19
HLRS 4025-05-160		16		16.53	17.05	17.61	18.21	No Interference
HLRS 4025-05-200		20		20.66	21.31	22.01	No Interference	No Interference
HLRS 4025-05-300		30		30.97	31.96	No Interference	No Interference	No Interference

4 Flutes

$\phi 3$ mm Shank V Series

UDC-PCD Series

CBN Series

Square

Long Neck Square

Radius

Long Neck Radius

Taper Neck Radius

Ball / Long Shank Ball

Long Neck Ball

Taper Neck Ball

Taper

Barrel

Spiral V Cutter

Drill

Technical Data

Unit (mm)

Model Number	Outside Diameter ϕD	Corner Radius CR	Effective Length ℓ_1	Length of Cut ℓ	Neck Diameter ϕd_1	Shank Taper Angle β	Overall Length L	Shank Diameter ϕd	Suggested Retail Price ¥	
HLRS 4030-005-040	3	RO.05	4	2.4	2.92	16°	55	6	7,100	
HLRS 4030-005-060			6				55	6	7,100	
HLRS 4030-005-080			8				55	6	7,100	
HLRS 4030-005-100			10				55	6	7,100	
HLRS 4030-005-120			12				55	6	8,600	
HLRS 4030-005-160			16				60	6	10,600	
HLRS 4030-005-200		20	60				6	10,600		
HLRS 4030-01-040		RO.1	4				55	6	7,100	
HLRS 4030-01-060			6				55	6	7,100	
HLRS 4030-01-080			8				55	6	7,100	
HLRS 4030-01-100			10				55	6	7,100	
HLRS 4030-01-120			12				55	6	8,600	
HLRS 4030-01-160			16				60	6	10,600	
HLRS 4030-01-180			18				60	6	10,600	
HLRS 4030-01-200			20				60	6	10,600	
HLRS 4030-01-240			24				70	6	10,600	
HLRS 4030-01-260			26				70	6	10,600	
HLRS 4030-01-300			30				70	6	12,000	
HLRS 4030-02-040			RO.2				4	55	6	7,100
HLRS 4030-02-060							6	55	6	7,100
HLRS 4030-02-080							8	55	6	7,100
HLRS 4030-02-100							10	55	6	7,100
HLRS 4030-02-120							12	55	6	8,600
HLRS 4030-02-160							16	60	6	10,600
HLRS 4030-02-180							18	60	6	10,600
HLRS 4030-02-200		20					60	6	10,600	
HLRS 4030-02-240		24					70	6	10,600	
HLRS 4030-02-260		26					70	6	10,600	
HLRS 4030-02-300		30					70	6	12,000	
HLRS 4030-02-360		36					80	6	12,000	
HLRS 4030-03-040		RO.3	4				55	6	7,100	
HLRS 4030-03-060			6				55	6	7,100	
HLRS 4030-03-080			8				55	6	7,100	
HLRS 4030-03-100			10				55	6	7,100	
HLRS 4030-03-120			12				55	6	8,600	
HLRS 4030-03-140			14				55	6	8,600	
HLRS 4030-03-160	16		60	6	10,600					
HLRS 4030-03-200	20		60	6	10,600					
HLRS 4030-03-240	24		70	6	10,600					
HLRS 4030-03-260	26		70	6	10,600					
HLRS 4030-03-300	30		70	6	12,000					
HLRS 4030-03-360	36		80	6	12,000					

φ3mm Shank V Series

UDC-PCD Series

CBN Series

Square
Long Neck Square

Radius
Long Neck Radius
Taper Neck Radius

Ball / Long Shank Ball
Long Neck Ball
Taper Neck Ball

Taper

Barrel

Spiral V Cutter

Drill

Technical Data

Model Number	Outside Diameter ϕD	Corner Radius CR	Effective Length l_1	Effective Length by Inclined Angles				
				30'	1°	1°30'	2°	3°
HLRS 4030-005-040	3	RO.05	4	4.17	4.31	4.45	4.60	4.95
HLRS 4030-005-060			6	6.23	6.43	6.65	6.88	7.40
HLRS 4030-005-080			8	8.30	8.56	8.85	9.16	9.84
HLRS 4030-005-100			10	10.36	10.69	11.05	11.44	12.29
HLRS 4030-005-120			12	12.42	12.82	13.25	13.71	14.74
HLRS 4030-005-160			16	16.55	17.08	17.66	18.27	19.63
HLRS 4030-005-200			20	20.67	21.34	22.06	22.82	24.53
HLRS 4030-01-040		RO.1	4	4.17	4.30	4.44	4.60	4.94
HLRS 4030-01-060			6	6.23	6.43	6.65	6.87	7.38
HLRS 4030-01-080			8	8.29	8.56	8.85	9.15	9.83
HLRS 4030-01-100			10	10.36	10.69	11.05	11.43	12.28
HLRS 4030-01-120			12	12.42	12.82	13.25	13.71	14.73
HLRS 4030-01-160			16	16.54	17.08	17.65	18.26	19.62
HLRS 4030-01-180			18	18.61	19.21	19.85	20.54	22.07
HLRS 4030-01-200			20	20.67	21.34	22.05	22.82	24.52
HLRS 4030-01-240			24	24.80	25.60	26.45	27.37	No Interference
HLRS 4030-01-260			26	26.86	27.73	28.66	29.65	No Interference
HLRS 4030-01-300		30	30.98	31.99	33.06	34.20	No Interference	
HLRS 4030-02-040		RO.2	4	4.17	4.30	4.43	4.58	4.92
HLRS 4030-02-060			6	6.23	6.43	6.64	6.86	7.36
HLRS 4030-02-080			8	8.29	8.55	8.84	9.14	9.81
HLRS 4030-02-100			10	10.35	10.68	11.04	11.42	12.26
HLRS 4030-02-120			12	12.42	12.81	13.24	13.69	14.70
HLRS 4030-02-160			16	16.54	17.07	17.64	18.25	19.60
HLRS 4030-02-180			18	18.60	19.20	19.84	20.53	22.05
HLRS 4030-02-200			20	20.67	21.33	22.04	22.80	24.49
HLRS 4030-02-240			24	24.79	25.59	26.44	27.36	No Interference
HLRS 4030-02-260			26	26.86	27.72	28.65	29.63	No Interference
HLRS 4030-02-300		30	30.98	31.98	33.05	34.19	No Interference	
HLRS 4030-02-360		36	37.17	38.37	39.65	41.02	No Interference	
HLRS 4030-03-040		RO.3	4	4.16	4.29	4.42	4.57	4.89
HLRS 4030-03-060			6	6.22	6.42	6.63	6.85	7.34
HLRS 4030-03-080			8	8.29	8.55	8.83	9.12	9.79
HLRS 4030-03-100			10	10.35	10.68	11.03	11.40	12.24
HLRS 4030-03-120			12	12.41	12.81	13.23	13.68	14.68
HLRS 4030-03-140			14	14.48	14.94	15.43	15.96	17.13
HLRS 4030-03-160	16		16.54	17.07	17.63	18.23	19.58	
HLRS 4030-03-200	20		20.66	21.33	22.03	22.79	24.47	
HLRS 4030-03-240	24		24.79	25.59	26.43	27.34	No Interference	
HLRS 4030-03-260	26		26.85	27.71	28.64	29.62	No Interference	
HLRS 4030-03-300	30	30.98	31.97	33.04	34.18	No Interference		
HLRS 4030-03-360	36	37.17	38.36	39.64	41.01	No Interference		

4 Flutes

 $\phi 3$ mm Shank
V SeriesUDC-PCD
SeriesCBN
Series

Square

Square

Long Neck
Square

Radius

Radius

Long Neck
RadiusTaper Neck
RadiusBall / Long
Shank Ball

Ball

Long Neck
BallTaper Neck
Ball

Taper

Taper

Barrel

Spiral
V Cutter

Drill

Technical Data

Model Number	Outside Diameter ϕD	Corner Radius CR	Effective Length ℓ_1	Length of Cut ℓ	Neck Diameter ϕd_1	Shank Taper Angle β	Overall Length L	Shank Diameter ϕd	Suggested Retail Price ¥
HLRS 4030-05-040	3	RO.5	4	2.4	2.92	16°	55	6	7,100
HLRS 4030-05-060			6				55	6	7,100
HLRS 4030-05-080			8				55	6	7,100
HLRS 4030-05-100			10				55	6	7,100
HLRS 4030-05-120			12				55	6	8,600
HLRS 4030-05-160			16				60	6	10,600
HLRS 4030-05-200			20				60	6	10,600
HLRS 4030-05-240			24				70	6	10,600
HLRS 4030-05-260			26				70	6	10,600
HLRS 4030-05-300			30				70	6	12,000
HLRS 4030-05-360		36	80				6	12,000	
HLRS 4030-10-060		R1	6				55	6	7,100
HLRS 4030-10-080			8				55	6	7,100
HLRS 4030-10-100			10				55	6	7,100
HLRS 4030-10-120			12				55	6	8,600
HLRS 4030-10-160			16				60	6	10,600
HLRS 4030-10-200			20				60	6	10,600
HLRS 4030-10-240			24				70	6	10,600
HLRS 4030-10-260			26				70	6	10,600
HLRS 4030-10-300			30				70	6	12,000
HLRS 4030-10-360	36		80	6	12,000				
HLRS 4040-005-080	4	RO.05	8	3.2	3.82	16°	65	6	10,600
HLRS 4040-005-120			12				65	6	10,600
HLRS 4040-005-160			16				65	6	10,600
HLRS 4040-005-200			20				70	6	11,800
HLRS 4040-005-240			24				70	6	11,800
HLRS 4040-005-320			32				80	6	11,800
HLRS 4040-01-080		RO.1	8				65	6	10,600
HLRS 4040-01-120			12				65	6	10,600
HLRS 4040-01-160			16				65	6	10,600
HLRS 4040-01-200			20				70	6	11,800
HLRS 4040-01-240			24				70	6	11,800
HLRS 4040-01-320			32				80	6	11,800
HLRS 4040-01-480		48	100				6	18,800	
HLRS 4040-02-080		RO.2	8				65	6	10,600
HLRS 4040-02-120			12				65	6	10,600
HLRS 4040-02-160			16				65	6	10,600
HLRS 4040-02-200			20				70	6	11,800
HLRS 4040-02-240			24				70	6	11,800
HLRS 4040-02-320			32				80	6	11,800
HLRS 4040-02-480			48				100	6	18,800

- $\phi 3$ mm Shank V Series
- UDC-PCD Series
- CBN Series
- Square
- Long Neck Square
- Radius
- Long Neck Radius
- Taper Neck Radius
- Ball / Long Shank Ball
- Long Neck Ball
- Taper Neck Ball
- Taper
- Barrel
- Spiral V Cutter
- Drill
- Technical Data

Model Number	Outside Diameter ϕD	Corner Radius CR	Effective Length l_1	Effective Length by Inclined Angles				
				30'	1°	1°30'	2°	3°
HLRS 4030-05-040	3	RO.5	4	4.15	4.27	4.40	4.54	4.85
HLRS 4030-05-060			6	6.22	6.40	6.60	6.82	7.30
HLRS 4030-05-080			8	8.28	8.53	8.80	9.10	9.74
HLRS 4030-05-100			10	10.34	10.66	11.01	11.37	12.19
HLRS 4030-05-120			12	12.40	12.79	13.21	13.65	14.64
HLRS 4030-05-160			16	16.53	17.05	17.61	18.20	19.53
HLRS 4030-05-200			20	20.66	21.31	22.01	22.76	24.43
HLRS 4030-05-240			24	24.78	25.57	26.41	27.31	29.32
HLRS 4030-05-260			26	26.84	27.70	28.61	29.59	No Interference
HLRS 4030-05-300			30	30.97	31.96	33.02	34.15	No Interference
HLRS 4030-05-360		36	37.16	38.35	39.62	40.98	No Interference	
HLRS 4030-10-060		R1	6	6.20	6.37	6.55	6.75	7.18
HLRS 4030-10-080			8	8.26	8.50	8.75	9.03	9.63
HLRS 4030-10-100			10	10.32	10.63	10.95	11.30	12.08
HLRS 4030-10-120			12	12.39	12.76	13.16	13.58	14.53
HLRS 4030-10-160			16	16.51	17.02	17.56	18.13	19.42
HLRS 4030-10-200			20	20.64	21.28	21.96	22.69	24.32
HLRS 4030-10-240			24	24.76	25.54	26.36	27.24	29.21
HLRS 4030-10-260			26	26.83	27.67	28.56	29.52	No Interference
HLRS 4030-10-300			30	30.95	31.93	32.96	34.08	No Interference
HLRS 4030-10-360	36		37.14	38.31	39.57	40.91	No Interference	
HLRS 4040-005-080	4	RO.05	8	8.48	8.75	9.04	9.36	10.06
HLRS 4040-005-120			12	12.60	13.01	13.45	13.91	14.95
HLRS 4040-005-160			16	16.73	17.27	17.85	18.47	No Interference
HLRS 4040-005-200			20	20.85	21.53	22.25	23.02	No Interference
HLRS 4040-005-240			24	24.98	25.79	26.65	27.58	No Interference
HLRS 4040-005-320			32	33.23	34.31	35.46	No Interference	No Interference
HLRS 4040-01-080		RO.1	8	8.47	8.75	9.04	9.35	10.05
HLRS 4040-01-120			12	12.60	13.01	13.44	13.91	14.94
HLRS 4040-01-160			16	16.72	17.27	17.84	18.46	No Interference
HLRS 4040-01-200			20	20.85	21.52	22.24	23.01	No Interference
HLRS 4040-01-240			24	24.98	25.78	26.65	27.57	No Interference
HLRS 4040-01-320			32	33.23	34.30	35.45	No Interference	No Interference
HLRS 4040-01-480			48	49.73	51.34	No Interference	No Interference	No Interference
HLRS 4040-02-080			RO.2	8	8.47	8.74	9.03	9.34
HLRS 4040-02-120		12		12.60	13.00	13.43	13.89	14.92
HLRS 4040-02-160		16		16.72	17.26	17.83	18.45	No Interference
HLRS 4040-02-200		20		20.85	21.52	22.23	23.00	No Interference
HLRS 4040-02-240		24		24.97	25.78	26.64	27.56	No Interference
HLRS 4040-02-320		32		33.22	34.30	35.44	No Interference	No Interference
HLRS 4040-02-480		48		49.73	51.33	No Interference	No Interference	No Interference

4 Flutes

 $\phi 3\text{mm}$ Shank
V SeriesUDC-PCD
SeriesCBN
Series

Square

Square
Long Neck
Square

Radius

Radius
Long Neck
RadiusTaper Neck
RadiusBall / Long
Shank BallBall
Long Neck
BallTaper Neck
Ball

Taper

Taper

Barrel

Spiral
V Cutter

Drill

Technical Data

Unit (mm)

Model Number	Outside Diameter ϕD	Corner Radius CR	Effective Length ℓ_1	Length of Cut ℓ	Neck Diameter ϕd_1	Shank Taper Angle β	Overall Length L	Shank Diameter ϕd	Suggested Retail Price ¥
HLRS 4040-03-080	4	RO.3	8	3.2	3.82	16°	65	6	10,600
HLRS 4040-03-120			12				65	6	10,600
HLRS 4040-03-140			14				65	6	10,600
HLRS 4040-03-160			16				65	6	10,600
HLRS 4040-03-200			20				70	6	11,800
HLRS 4040-03-240			24				70	6	11,800
HLRS 4040-03-320			32				80	6	11,800
HLRS 4040-03-480			48				100	6	18,800
HLRS 4040-05-080		RO.5	8				65	6	10,600
HLRS 4040-05-120			12				65	6	10,600
HLRS 4040-05-160			16				65	6	10,600
HLRS 4040-05-200			20				70	6	11,800
HLRS 4040-05-240			24				70	6	11,800
HLRS 4040-05-320			32				80	6	11,800
HLRS 4040-05-400			40				100	6	17,500
HLRS 4040-05-480			48				100	6	18,800
HLRS 4040-10-080		R1	8				65	6	10,600
HLRS 4040-10-120			12				65	6	10,600
HLRS 4040-10-160			16				65	6	10,600
HLRS 4040-10-200			20				70	6	11,800
HLRS 4040-10-240	24		70	6	11,800				
HLRS 4040-10-320	32		80	6	11,800				
HLRS 4040-10-480	48		100	6	18,800				
HLRS 4050-005-160	5		RO.05	16	4	4.82	16°	65	6
HLRS 4050-005-200		20		70				6	14,000
HLRS 4050-005-400		40		100				6	17,500
HLRS 4050-01-160		RO.1	16	65				6	14,300
HLRS 4050-01-200			20	70				6	14,000
HLRS 4050-01-400			40	100				6	17,500
HLRS 4050-02-160		RO.2	16	65				6	14,000
HLRS 4050-02-200			20	70				6	14,000
HLRS 4050-02-400			40	100				6	17,500
HLRS 4050-03-160		RO.3	16	65				6	14,000
HLRS 4050-03-200			20	70				6	14,000
HLRS 4050-03-400			40	100				6	17,500
HLRS 4050-05-160		RO.5	16	65				6	14,000
HLRS 4050-05-200			20	70				6	14,000
HLRS 4050-05-400			40	100				6	17,500
HLRS 4050-10-160		R1	16	65				6	14,000
HLRS 4050-10-200			20	70				6	14,000
HLRS 4050-10-400			40	100				6	17,500

- $\phi 3$ mm Shank V Series
- UDC-PCD Series
- CBN Series
- Square
- Long Neck Square
- Radius
- Long Neck Radius
- Taper Neck Radius
- Ball / Long Shank Ball
- Long Neck Ball
- Taper Neck Ball
- Taper
- Barrel
- Spiral V Cutter
- Drill
- Technical Data

Model Number	Outside Diameter ϕD	Corner Radius CR	Effective Length l_1	Effective Length by Inclined Angles				
				30'	1°	1°30'	2°	3°
HLRS 4040-03-080	4	RO.3	8	8.47	8.73	9.02	9.32	10.00
HLRS 4040-03-120			12	12.59	12.99	13.42	13.88	14.90
HLRS 4040-03-140			14	14.66	15.12	15.62	16.16	17.34
HLRS 4040-03-160			16	16.72	17.25	17.82	18.43	No Interference
HLRS 4040-03-200			20	20.84	21.51	22.22	22.99	No Interference
HLRS 4040-03-240			24	24.97	25.77	26.63	27.54	No Interference
HLRS 4040-03-320			32	33.22	34.29	35.43	No Interference	No Interference
HLRS 4040-03-480			48	49.72	51.33	No Interference	No Interference	No Interference
HLRS 4040-05-080		RO.5	8	8.46	8.72	9.00	9.29	9.96
HLRS 4040-05-120			12	12.58	12.98	13.40	13.85	14.85
HLRS 4040-05-160			16	16.71	17.24	17.80	18.40	19.75
HLRS 4040-05-200			20	20.84	21.50	22.20	22.96	No Interference
HLRS 4040-05-240			24	24.96	25.76	26.60	27.51	No Interference
HLRS 4040-05-320			32	33.21	34.27	35.41	No Interference	No Interference
HLRS 4040-05-400			40	41.46	42.79	No Interference	No Interference	No Interference
HLRS 4040-05-480			48	49.71	51.31	No Interference	No Interference	No Interference
HLRS 4040-10-080		R1	8	8.44	8.69	8.95	9.22	9.84
HLRS 4040-10-120			12	12.57	12.94	13.35	13.78	14.74
HLRS 4040-10-160			16	16.69	17.20	17.75	18.33	19.63
HLRS 4040-10-200			20	20.82	21.46	22.15	22.89	No Interference
HLRS 4040-10-240			24	24.94	25.72	26.55	27.44	No Interference
HLRS 4040-10-320			32	33.20	34.24	35.36	No Interference	No Interference
HLRS 4040-10-480			48	49.70	51.28	No Interference	No Interference	No Interference
HLRS 4050-005-160			5	RO.05	16	16.73	17.27	17.85
HLRS 4050-005-200	20	20.85			21.53	No Interference	No Interference	No Interference
HLRS 4050-005-400	40	41.48			No Interference	No Interference	No Interference	No Interference
HLRS 4050-01-160	RO.1	16		16.72	17.27	17.84	No Interference	No Interference
HLRS 4050-01-200		20		20.85	21.52	No Interference	No Interference	No Interference
HLRS 4050-01-400		40		41.48	No Interference	No Interference	No Interference	No Interference
HLRS 4050-02-160	RO.2	16		16.72	17.26	17.83	No Interference	No Interference
HLRS 4050-02-200		20		20.85	21.52	No Interference	No Interference	No Interference
HLRS 4050-02-400		40		41.47	No Interference	No Interference	No Interference	No Interference
HLRS 4050-03-160	RO.3	16		16.72	17.25	17.82	No Interference	No Interference
HLRS 4050-03-200		20		20.84	21.51	No Interference	No Interference	No Interference
HLRS 4050-03-400		40		41.47	No Interference	No Interference	No Interference	No Interference
HLRS 4050-05-160	RO.5	16		16.71	17.24	17.80	No Interference	No Interference
HLRS 4050-05-200		20		20.83	21.50	No Interference	No Interference	No Interference
HLRS 4050-05-400		40		41.46	No Interference	No Interference	No Interference	No Interference
HLRS 4050-10-160	R1	16		16.69	17.20	17.74	No Interference	No Interference
HLRS 4050-10-200		20		20.81	21.46	No Interference	No Interference	No Interference
HLRS 4050-10-400		40		41.44	No Interference	No Interference	No Interference	No Interference

4 Flutes

$\phi 3\text{mm}$ Shank V Series

UDC-PCD Series

CBN Series

Square

Long Neck Square

Radius

Long Neck Radius

Taper Neck Radius

Ball / Long Shank Ball

Long Neck Ball

Taper Neck Ball

Taper

Barrel

Spiral V Cutter

Drill

Technical Data

Unit (mm)

Model Number	Outside Diameter ϕD	Corner Radius CR	Effective Length ℓ_1	Length of Cut ℓ	Neck Diameter ϕd_1	Shank Taper Angle Bta	Overall Length L	Shank Diameter ϕd	Suggested Retail Price ¥	
HLRS 4060-005-120	6	R0.05	12	4.8	5.82	—	65	6	15,400	
HLRS 4060-005-160			16				65	6	15,400	
HLRS 4060-005-200			20				70	6	15,400	
HLRS 4060-005-240			24				70	6	15,400	
HLRS 4060-005-300			30				100	6	18,000	
HLRS 4060-005-480			48				120	6	24,000	
HLRS 4060-01-120		R0.1	12				65	6	15,400	
HLRS 4060-01-160			16				65	6	15,400	
HLRS 4060-01-180			18				70	6	15,400	
HLRS 4060-01-200			20				70	6	15,400	
HLRS 4060-01-240			24				70	6	15,400	
HLRS 4060-01-300			30				100	6	18,000	
HLRS 4060-01-480			48				120	6	24,000	
HLRS 4060-02-120			R0.2				12	65	6	15,400
HLRS 4060-02-160							16	65	6	15,400
HLRS 4060-02-180							18	70	6	15,400
HLRS 4060-02-200							20	70	6	15,400
HLRS 4060-02-240							24	70	6	15,400
HLRS 4060-02-300		30					100	6	18,000	
HLRS 4060-02-480		48	120				6	24,000		
HLRS 4060-03-120		R0.3	12				65	6	15,400	
HLRS 4060-03-160			16				65	6	15,400	
HLRS 4060-03-180			18				70	6	15,400	
HLRS 4060-03-200			20				70	6	15,400	
HLRS 4060-03-240			24				70	6	15,400	
HLRS 4060-03-300			30				100	6	18,000	
HLRS 4060-03-480		48	120				6	24,000		
HLRS 4060-05-120		R0.5	12				65	6	15,400	
HLRS 4060-05-160			16				65	6	15,400	
HLRS 4060-05-180			18				70	6	15,400	
HLRS 4060-05-200			20				70	6	15,400	
HLRS 4060-05-240			24				70	6	15,400	
HLRS 4060-05-300			30				100	6	18,000	
HLRS 4060-05-400			40				100	6	18,000	
HLRS 4060-05-480			48				120	6	24,000	
HLRS 4060-10-120			R1				12	65	6	15,400
HLRS 4060-10-160							16	65	6	15,400
HLRS 4060-10-180							18	70	6	15,400
HLRS 4060-10-200							20	70	6	15,400
HLRS 4060-10-240		24					70	6	15,400	
HLRS 4060-10-300		30					100	6	18,000	
HLRS 4060-10-400		40					100	6	18,000	
HLRS 4060-10-480		48					120	6	24,000	

φ3mm Shank V Series

UDC-PCD Series

CBN Series

Square
Long Neck Square

Radius

Radius
Long Neck Radius
Taper Neck Radius

Ball / Long Shank Ball

Ball
Long Neck Ball
Taper Neck Ball

Taper

Barrel

Spiral V Cutter

Drill

Technical Data

Unit (mm)

Model Number	Outside Diameter ϕD	Corner Radius CR	Effective Length l_1	Effective Length by Inclined Angles				
				30'	1°	1°30'	2°	3°
HLRS 4060-005-120	6	RO.05	12	No Interference	No Interference	No Interference	No Interference	No Interference
HLRS 4060-005-160			16	No Interference	No Interference	No Interference	No Interference	No Interference
HLRS 4060-005-200			20	No Interference	No Interference	No Interference	No Interference	No Interference
HLRS 4060-005-240			24	No Interference	No Interference	No Interference	No Interference	No Interference
HLRS 4060-005-300			30	No Interference	No Interference	No Interference	No Interference	No Interference
HLRS 4060-005-480			48	No Interference	No Interference	No Interference	No Interference	No Interference
HLRS 4060-01-120		RO.1	12	No Interference	No Interference	No Interference	No Interference	No Interference
HLRS 4060-01-160			16	No Interference	No Interference	No Interference	No Interference	No Interference
HLRS 4060-01-180			18	No Interference	No Interference	No Interference	No Interference	No Interference
HLRS 4060-01-200			20	No Interference	No Interference	No Interference	No Interference	No Interference
HLRS 4060-01-240			24	No Interference	No Interference	No Interference	No Interference	No Interference
HLRS 4060-01-300			30	No Interference	No Interference	No Interference	No Interference	No Interference
HLRS 4060-01-480		48	No Interference	No Interference	No Interference	No Interference	No Interference	
HLRS 4060-02-120		RO.2	12	No Interference	No Interference	No Interference	No Interference	No Interference
HLRS 4060-02-160			16	No Interference	No Interference	No Interference	No Interference	No Interference
HLRS 4060-02-180			18	No Interference	No Interference	No Interference	No Interference	No Interference
HLRS 4060-02-200			20	No Interference	No Interference	No Interference	No Interference	No Interference
HLRS 4060-02-240			24	No Interference	No Interference	No Interference	No Interference	No Interference
HLRS 4060-02-300			30	No Interference	No Interference	No Interference	No Interference	No Interference
HLRS 4060-02-480		48	No Interference	No Interference	No Interference	No Interference	No Interference	
HLRS 4060-03-120		RO.3	12	No Interference	No Interference	No Interference	No Interference	No Interference
HLRS 4060-03-160			16	No Interference	No Interference	No Interference	No Interference	No Interference
HLRS 4060-03-180			18	No Interference	No Interference	No Interference	No Interference	No Interference
HLRS 4060-03-200			20	No Interference	No Interference	No Interference	No Interference	No Interference
HLRS 4060-03-240			24	No Interference	No Interference	No Interference	No Interference	No Interference
HLRS 4060-03-300			30	No Interference	No Interference	No Interference	No Interference	No Interference
HLRS 4060-03-480		48	No Interference	No Interference	No Interference	No Interference	No Interference	
HLRS 4060-05-120		RO.5	12	No Interference	No Interference	No Interference	No Interference	No Interference
HLRS 4060-05-160			16	No Interference	No Interference	No Interference	No Interference	No Interference
HLRS 4060-05-180			18	No Interference	No Interference	No Interference	No Interference	No Interference
HLRS 4060-05-200			20	No Interference	No Interference	No Interference	No Interference	No Interference
HLRS 4060-05-240			24	No Interference	No Interference	No Interference	No Interference	No Interference
HLRS 4060-05-300			30	No Interference	No Interference	No Interference	No Interference	No Interference
HLRS 4060-05-400		40	No Interference	No Interference	No Interference	No Interference	No Interference	
HLRS 4060-05-480		48	No Interference	No Interference	No Interference	No Interference	No Interference	
HLRS 4060-10-120		R1	12	No Interference	No Interference	No Interference	No Interference	No Interference
HLRS 4060-10-160			16	No Interference	No Interference	No Interference	No Interference	No Interference
HLRS 4060-10-180			18	No Interference	No Interference	No Interference	No Interference	No Interference
HLRS 4060-10-200			20	No Interference	No Interference	No Interference	No Interference	No Interference
HLRS 4060-10-240			24	No Interference	No Interference	No Interference	No Interference	No Interference
HLRS 4060-10-300			30	No Interference	No Interference	No Interference	No Interference	No Interference
HLRS 4060-10-400		40	No Interference	No Interference	No Interference	No Interference	No Interference	
HLRS 4060-10-480		48	No Interference	No Interference	No Interference	No Interference	No Interference	

4 Flutes

$\phi 3$ mm Shank V Series

UDC-PCD Series

CBN Series

Square
Long Neck Square

Radius
Long Neck Radius

Taper Neck Radius

Ball / Long Shank Ball

Long Neck Ball

Taper Neck Ball

Taper

Barrel

Spiral V Cutter

Drill

Technical Data

Milling Conditions for HLRS (4 Flutes)

WORK MATERIAL			PREHARDENED STEELS HARDENED STEELS NAK / SKD (30~45HRC)				HARDENED STEELS SKD / SKT (45~55HRC)				HARDENED STEELS SKD / SKH (55~65HRC)			
Model Number	Outside Diameter (mm)	Effective Length (mm)	Spindle Speed (min ⁻¹)	Feed Rate (mm/min)	a_p Axial Depth (mm)	a_e Radial Depth (mm)	Spindle Speed (min ⁻¹)	Feed Rate (mm/min)	a_p Axial Depth (mm)	a_e Radial Depth (mm)	Spindle Speed (min ⁻¹)	Feed Rate (mm/min)	a_p Axial Depth (mm)	a_e Radial Depth (mm)
4002	0.2	0.3	27,000	620	0.005	0.05	27,000	500	0.003	0.04	27,000	390	0.003	0.01
		0.5	24,000	500	0.005	0.05	24,000	410	0.003	0.04	24,000	250	0.003	0.01
		1	21,000	380	0.004	0.05	21,000	320	0.002	0.04	21,000	110	0.002	0.009
		1.5	18,000	260	0.004	0.05	18,000	240	0.002	0.03	18,000	80	0.002	0.007
		2	15,000	140	0.004	0.05	15,000	160	0.002	0.03	15,000	60	0.002	0.007
4003	0.3	0.3	24,500	660	0.01	0.075	23,700	530	0.006	0.07	20,000	330	0.003	0.028
		0.5	23,300	600	0.008	0.075	22,500	490	0.006	0.07	18,500	270	0.003	0.028
		1	20,400	460	0.006	0.075	19,500	400	0.005	0.07	17,000	180	0.003	0.028
		1.5	17,500	320	0.004	0.05	16,500	310	0.005	0.07	16,000	140	0.003	0.025
4004	0.4	0.5	25,400	870	0.015	0.12	22,500	750	0.011	0.1	16,200	360	0.003	0.05
		1	22,600	700	0.012	0.12	20,500	600	0.009	0.1	15,000	250	0.003	0.045
		1.5	21,200	610	0.01	0.12	19,500	520	0.008	0.095	14,400	150	0.003	0.043
4005	0.5	1	22,000	800	0.017	0.155	20,000	670	0.012	0.125	13,500	300	0.003	0.065
		2	19,300	610	0.013	0.155	18,000	530	0.01	0.12	12,300	170	0.003	0.06
4006	0.6	2	21,300	900	0.018	0.17	19,000	750	0.015	0.145	11,500	240	0.003	0.083
		4	18,600	690	0.013	0.17	15,500	520	0.013	0.14	10,300	50	0.003	0.07
4008	0.8	2	20,000	1,100	0.025	0.2	18,500	950	0.02	0.2	10,000	280	0.005	0.12
		3	18,800	950	0.021	0.2	16,500	830	0.018	0.2	9,200	200	0.005	0.116
		4	17,500	840	0.018	0.2	15,000	730	0.016	0.2	8,800	120	0.004	0.112
		6	14,600	700	0.015	0.2	12,500	600	0.015	0.2	8,500	60	0.004	0.108
4010	1	8	13,100	450	0.008	0.13	11,150	425	0.008	0.125	7,500	50	0.003	0.057
		2	17,600	1,470	0.056	0.27	15,300	1,200	0.038	0.27	10,900	710	0.03	0.27
		3	15,500	1,390	0.048	0.27	13,200	1,150	0.037	0.27	9,400	680	0.027	0.27
		4	13,800	1,310	0.039	0.27	12,000	1,070	0.031	0.243	8,500	640	0.015	0.243
		5	12,500	1,150	0.03	0.24	11,000	960	0.027	0.232	7,800	570	0.013	0.144
		6	11,300	1,040	0.021	0.216	9,800	860	0.016	0.209	7,000	510	0.01	0.108
		8	9,800	780	0.02	0.189	8,500	720	0.012	0.16	6,100	420	0.008	0.094
		10	8,800	510	0.011	0.126	7,600	510	0.009	0.1	5,400	350	0.006	0.05
4012	1.2	12	8,100	320	0.008	0.1	7,000	400	0.006	0.05	5,000	300	0.006	0.03
		16	7,000	150	0.005	0.06	6,100	330	0.006	0.05	4,300	250	0.005	0.01
		4	13,200	1,360	0.032	0.45	11,900	1,100	0.024	0.3	9,200	1,300	0.02	0.2
4015	1.5	6	11,200	1,160	0.028	0.36	9,600	980	0.022	0.252	7,400	1,200	0.011	0.095
		10	9,000	800	0.017	0.18	7,300	600	0.009	0.15	6,300	800	0.006	0.05
		3	16,400	1,520	0.063	0.569	14,800	1,330	0.052	0.54	11,200	780	0.035	0.315
		4	13,200	1,360	0.054	0.54	13,200	1,280	0.042	0.495	10,100	700	0.033	0.292
		6	11,600	1,280	0.041	0.486	10,600	1,210	0.038	0.445	8,100	460	0.025	0.202
		8	10,200	1,080	0.037	0.378	9,300	1,020	0.031	0.346	7,100	390	0.015	0.157
		10	9,300	930	0.032	0.345	8,500	870	0.029	0.316	6,600	340	0.011	0.172
		12	8,500	830	0.029	0.324	7,800	780	0.026	0.297	5,900	300	0.01	0.162
4018	1.8	16	7,400	670	0.018	0.216	6,800	600	0.014	0.198	5,100	230	0.005	0.108
		18	6,000	550	0.015	0.2	5,800	420	0.01	0.15	4,200	150	0.005	0.08
		8	10,700	1,120	0.047	0.495	9,800	1,060	0.043	0.497	7,700	500	0.02	0.222
		10	9,600	1,010	0.04	0.436	8,900	950	0.038	0.421	7,100	390	0.015	0.203
		12	8,100	850	0.035	0.303	7,500	740	0.032	0.306	5,900	290	0.013	0.159
		14	7,400	770	0.027	0.24	6,900	660	0.024	0.24	5,400	270	0.008	0.13
		16	7,200	730	0.021	0.207	6,700	630	0.019	0.198	5,200	260	0.006	0.113

Milling Conditions for HLRS (4 Flutes)

WORK MATERIAL			PREHARDENED STEELS HARDENED STEELS NAK / SKD (30~45HRC)				HARDENED STEELS SKD / SKT (45~55HRC)				HARDENED STEELS SKD / SKH (55~65HRC)			
Model Number	Outside Diameter (mm)	Effective Length (mm)	Spindle Speed (min ⁻¹)	Feed Rate (mm/min)	a_p Axial Depth (mm)	a_e Radial Depth (mm)	Spindle Speed (min ⁻¹)	Feed Rate (mm/min)	a_p Axial Depth (mm)	a_e Radial Depth (mm)	Spindle Speed (min ⁻¹)	Feed Rate (mm/min)	a_p Axial Depth (mm)	a_e Radial Depth (mm)
4020	2	4	15,300	1,570	0.069	0.72	14,300	1,460	0.065	0.81	11,500	860	0.031	0.36
		6	12,800	1,280	0.064	0.648	12,000	1,200	0.06	0.729	9,700	700	0.028	0.324
		8	11,200	1,160	0.058	0.612	10,400	1,100	0.055	0.648	8,400	600	0.026	0.288
		10	10,000	1,090	0.049	0.526	9,300	1,020	0.047	0.526	7,600	450	0.019	0.234
		12	9,100	1,030	0.046	0.405	8,500	960	0.044	0.405	6,900	420	0.018	0.18
		16	7,800	860	0.042	0.283	7,300	700	0.039	0.315	5,900	270	0.016	0.157
		20	7,000	800	0.025	0.198	6,600	650	0.024	0.198	5,300	290	0.007	0.118
		24	6,500	740	0.02	0.17	5,600	500	0.019	0.14	4,700	270	0.007	0.1
		26	6,000	680	0.013	0.15	5,000	440	0.012	0.12	4,000	220	0.005	0.08
30	5,500	620	0.01	0.1	4,400	390	0.009	0.09	3,400	180	0.005	0.08		
4025	2.5	6	13,000	1,600	0.078	0.7	12,000	1,500	0.074	0.7	9,900	830	0.05	0.476
		8	11,300	1,430	0.075	0.62	10,500	1,240	0.072	0.62	9,100	650	0.05	0.42
		10	10,500	1,400	0.067	0.54	10,000	1,150	0.067	0.54	8,400	510	0.048	0.324
		16	8,900	1,400	0.059	0.36	8,500	790	0.049	0.3	7,200	350	0.03	0.15
		20	7,800	1,200	0.048	0.27	7,500	670	0.031	0.225	6,300	300	0.022	0.09
30	6,300	600	0.011	0.18	6,000	500	0.014	0.18	5,000	220	0.01	0.054		
4030	3	4	15,000	3,070	0.128	0.72	14,000	2,640	0.08	0.72	11,500	980	0.052	0.576
		6	14,000	2,890	0.12	0.72	13,300	2,500	0.075	0.72	10,800	900	0.05	0.576
		8	12,500	2,530	0.105	0.7	11,800	2,200	0.07	0.7	9,900	810	0.047	0.56
		10	11,300	2,160	0.096	0.7	10,500	2,090	0.06	0.7	9,000	730	0.045	0.56
		12	10,500	2,020	0.084	0.67	10,000	1,950	0.052	0.67	8,100	660	0.037	0.502
		14	9,700	1,800	0.072	0.65	9,300	1,700	0.044	0.65	7,500	600	0.032	0.43
		16	9,200	1,680	0.064	0.63	8,800	1,600	0.04	0.63	7,100	570	0.027	0.378
		18	8,600	1,610	0.061	0.605	8,300	1,540	0.038	0.605	6,700	560	0.023	0.348
		20	8,400	1,540	0.058	0.58	7,900	1,490	0.036	0.58	6,300	550	0.022	0.319
		24	7,900	1,490	0.052	0.513	7,500	1,420	0.029	0.513	6,000	510	0.017	0.258
		26	7,500	1,440	0.046	0.446	7,100	1,360	0.023	0.446	5,700	480	0.012	0.198
		30	7,000	1,260	0.04	0.38	6,500	1,230	0.015	0.38	5,400	390	0.007	0.144
		36	6,500	1,100	0.035	0.3	6,100	1,110	0.01	0.18	5,100	300	0.005	0.1
4040	4	8	10,200	1,480	0.133	1.35	8,500	1,420	0.104	1.35	7,300	810	0.091	0.945
		12	8,900	1,440	0.116	1.15	7,600	1,390	0.091	1.15	6,400	780	0.065	0.805
		14	8,500	1,400	0.1	1.08	7,100	1,350	0.078	1.08	6,000	760	0.051	0.76
		16	7,900	1,370	0.091	1	6,600	1,330	0.071	1	5,600	740	0.043	0.7
		20	6,900	1,320	0.076	0.9	5,800	1,260	0.059	0.9	4,900	720	0.032	0.63
		24	6,200	1,200	0.06	0.8	5,200	1,120	0.047	0.8	4,500	630	0.022	0.56
		32	5,500	960	0.037	0.648	4,600	920	0.029	0.648	3,900	600	0.011	0.388
		40	5,000	790	0.025	0.55	4,300	800	0.02	0.482	3,600	560	0.008	0.3
		48	4,600	700	0.012	0.45	3,900	680	0.01	0.315	3,300	500	0.005	0.1
4050	5	16	7,200	1,700	0.15	1.5	5,300	1,200	0.125	1.15	4,200	820	0.063	1.03
		20	6,700	1,500	0.14	1.4	4,800	1,100	0.1	1.1	4,000	740	0.045	1
		40	4,600	880	0.068	1	3,300	700	0.06	0.68	2,800	500	0.025	0.44
4060	6	12	8,000	2,370	0.2	2.43	4,700	1,360	0.2	1.35	4,000	1,080	0.075	1.35
		16	6,700	2,020	0.19	2.394	4,000	1,150	0.19	1.33	3,400	900	0.073	1.33
		18	6,300	1,890	0.185	2.376	3,750	1,060	0.185	1.32	3,200	830	0.071	1.32
		20	5,800	1,730	0.18	2.358	3,500	1,000	0.18	1.31	3,000	760	0.07	1.31
		24	5,200	1,540	0.17	2.322	3,100	860	0.17	1.29	2,700	680	0.068	1.29
		30	4,500	1,290	0.158	2.268	2,600	740	0.158	1.26	2,200	580	0.066	1.26
		40	3,000	800	0.1	1.35	1,700	480	0.1	0.75	1,400	360	0.04	0.55
48	2,000	510	0.05	0.9	1,200	330	0.04	0.5	1,000	240	0.02	0.3		

4 Flutes

Ø3mm Shank
V Series

UDC-PCD
Series

CBN
Series

Square

Long Neck
Square

Radius

Long Neck
Radius

Taper Neck
Radius

Ball / Long
Shank Ball

Long Neck
Ball

Taper Neck
Ball

Taper

Barrel

Spiral
V Cutter

Drill

Technical Data

Side Milling

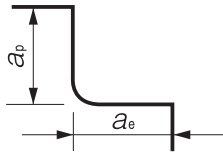

Note:

- Decrease both spindle speed and feed rate proportionally when the milling parameters exceed the machine's maximum spindle speed.
- Every coolant offers stable milling.
- Recommend oil coolant for Stainless Steels and Heat Resistant Alloys.
- Recommend wet coolant for Copper.

Ø3mm Shank
V Series

UDC-PCD
Series

CBN
Series

Square

Long Neck
Square

Square

Radius

Long Neck
Radius

Taper Neck
Radius

Radius

Ball / Long
Shank Ball

Long Neck
Ball

Taper Neck
Ball

Ball

Taper

Taper

Barrel

Spiral
V Cutter

Drill

Technical Data

Feature 1 : Variable pitch

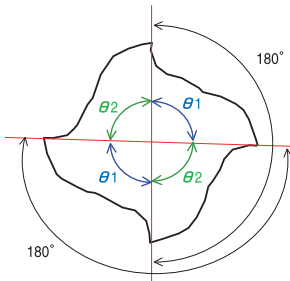

$\theta_1 > \theta_2$: The unequal division reduces chattering and tip damage.
 $\theta_1 + \theta_2 = 180^\circ$: Easy to measure outside diameter.

Feature 2 : Back taper geometry

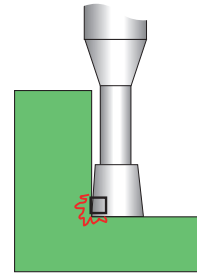

The back taper geometry reduces cutting resistance, which enables stable milling on vertical walls.

Milling Example for Deep Milling

HLRS4000 $\phi 2 \times \text{CR0.3} \times \text{EL16}$ ($L / D = 8$)

DAC10 (48HRC)

Tool	HLRS 4020-03-160
Spindle Speed	7,300 min^{-1}
Feed Rate	1,260 mm/min
a_p	0.02 mm
a_e	0.015 mm
Cycle Time	112 min
Coolant	Oil Mist
Work Size	20 \times 15 mm

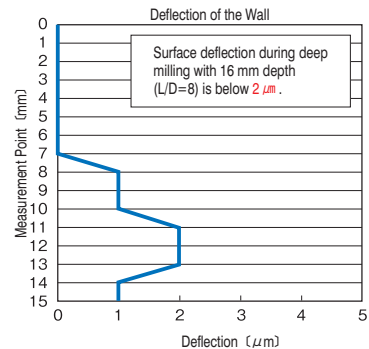
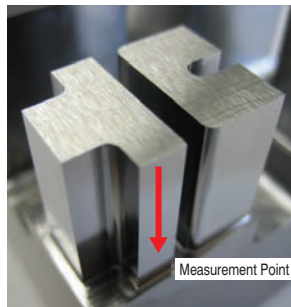

4 Flutes

$\phi 3\text{mm}$ Shank
V Series

UDC-PCD
Series

CBN
Series

Square

Long Neck
Square

Radius

Long Neck
Radius

Taper Neck
Radius

Ball / Long
Shank Ball

Long Neck
Ball

Taper Neck
Ball

Taper

Barrel

Spiral
V Cutter

Drill

Technical Data



Size $\phi 2 \sim \phi 12$

HRRS

Super
MG

HARD
MAX

45°

R

± 0.01

± 0.015

Shank Dia
0/-0.005

Back Taper
Geometry

Variable
Pitch

$\phi 2 \sim \phi 6$ $\phi 8 \sim \phi 12$

Material Applications (★ Highly Recommended ● Recommended ○ Suggested)

Work Material																	
Carbon Steels S45C S55C	Alloy Steels SK / SCM SUS	Prehardened Steels NAK HPM	Hardened Steels					Cast Iron	Aluminum Alloys	Graphite	Copper	Plastics	Glass Filled Plastics	Titanium Alloys	Heat Resistant Alloys	Cemented Carbide	Hard Brittle (Non-Metallic) Materials
			~50HRC	~55HRC	~60HRC	~65HRC	~70HRC										
		●	●	●	●	○		○									

Features

Special corner radius geometry offers greater milling amount and larger step over than a ball design. Seamless corner radius reduces cutting resistance and chattering. Suitable for milling hard materials up to 65HRC.

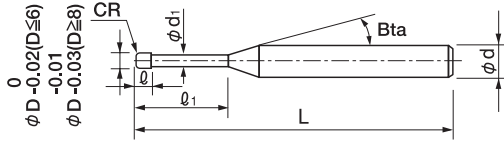

The shank taper angle shown is not an exact value and to avoid contact with the work piece, we recommend the user controls the precise value of this angle. Shank taper angle should not make contact with the work piece.

Total 49 models

Unit (mm)

Model Number	Outside Diameter ϕD	Corner Radius CR	Effective Length ℓ_1	Length of Cut ℓ	Neck Diameter ϕd_1	Shank Taper Angle Bta	Overall Length L	Shank Diameter ϕd	Suggested Retail Price ¥	
HRRS 4020-03-06	2	RO.3	6	2	1.91	16°	70	4	10,500	
HRRS 4020-05-06		RO.5					70	4	10,500	
HRRS 4030-08-09-3	3	RO.8	9	3	2.92	—	70	3	9,800	
HRRS 4030-08-09						16°	70	6	10,800	
HRRS 4040-03-12-6	4	RO.3	12	4	3.82	16°	70	6	11,600	
HRRS 4040-03-20-6			20				70	6	12,760	
HRRS 4040-05-12			—				70	4	10,000	
HRRS 4040-05-12-6		RO.5	12	4	3.82	16°	70	6	11,600	
HRRS 4040-05-20-6			20				70	6	12,760	
HRRS 4040-10-12		R1	—	12	4	3.82	16°	70	4	10,000
HRRS 4040-10-12-6				70				6	11,600	
HRRS 4040-10-20-6				20				70	6	12,760

Next Page ➡

Unit (mm)

Model Number	Outside Diameter ϕD	Corner Radius CR	Effective Length ℓ_1	Length of Cut ℓ	Neck Diameter ϕd_1	Shank Taper Angle β Bta	Overall Length L	Shank Diameter ϕd	Suggested Retail Price ¥
HRRS 4050-12-15	5	R1.2	15	5	4.82	16°	70	6	12,000
HRRS 4060-03-18	6	R0.3	18	6	5.82	—	90	6	13,400
HRRS 4060-03-30			30				90	6	14,740
HRRS 4060-05-18		R0.5	18				90	6	13,400
HRRS 4060-05-30			30				90	6	14,740
HRRS 4060-10-18		R1	18				90	6	13,400
HRRS 4060-10-30			30				90	6	14,740
HRRS 4060-15-18		R1.5	18				90	6	13,400
HRRS 4060-15-30			30				90	6	14,740
HRRS 4060-20-18		R2	18				90	6	13,400
HRRS 4080-03-24		8	R0.3				24	8	7.82
HRRS 4080-03-40	40			100	8	18,370			
HRRS 4080-05-24	R0.5		24	100	8	16,700			
HRRS 4080-05-40			40	100	8	18,370			
HRRS 4080-10-24	R1		24	100	8	16,700			
HRRS 4080-10-40			40	100	8	18,370			
HRRS 4080-20-24	R2		24	100	8	16,700			
HRRS 4080-20-40			40	100	8	18,370			
HRRS 4080-30-24	R3		24	100	8	16,700			
HRRS 4100-03-30	10		R0.3	30	10	9.82	—		
HRRS 4100-03-50		50		110				10	24,200
HRRS 4100-05-30		R0.5	30	110				10	22,000
HRRS 4100-05-50			50	110				10	24,200
HRRS 4100-10-30		R1	30	110				10	22,000
HRRS 4100-10-50			50	110				10	24,200
HRRS 4100-20-30		R2	30	110				10	22,000
HRRS 4100-20-50			50	110				10	24,200
HRRS 4100-30-30		R3	30	110				10	22,000
HRRS 4120-03-36		12	R0.3	36				12	11.82
HRRS 4120-03-60	60			120	12	30,470			
HRRS 4120-05-36	R0.5		36	120	12	27,700			
HRRS 4120-05-60			60	120	12	30,470			
HRRS 4120-10-36	R1		36	120	12	27,700			
HRRS 4120-10-60			60	120	12	30,470			
HRRS 4120-20-36	R2		36	120	12	27,700			
HRRS 4120-20-60			60	120	12	30,470			
HRRS 4120-40-36	R4		36	120	12	27,700			

4 Flutes

3mm Shank
V SeriesUDC-PCD
SeriesCBN
Series

Square

Square
Long Neck
Square

Radius

Radius
Long Neck
Radius
Taper Neck
Radius

Ball

Ball / Long
Shank Ball
Long Neck
Ball
Taper Neck
Ball

Taper

Taper

Barrel

Spiral
V Cutter

Drill

Technical Data

Milling Conditions for HRRS / HRRS-S

◆Roughing Effective length 3D

WORK MATERIAL			PREHARDENED STEELS / HARDENED STEELS (30~45HRC) (Air Blow / Oil Mist)				HARDENED STEELS (45~55HRC) (Air Blow / Oil Mist)				HARDENED STEELS (55~65HRC) (Air Blow / Oil Mist)			
Model Number	Outside Diameter (mm)	Corner Radius (mm)	Spindle Speed (min ⁻¹)	Feed Rate (mm/min)	a _p Axial Depth (mm)	a _e Radial Depth (mm)	Spindle Speed (min ⁻¹)	Feed Rate (mm/min)	a _p Axial Depth (mm)	a _e Radial Depth (mm)	Spindle Speed (min ⁻¹)	Feed Rate (mm/min)	a _p Axial Depth (mm)	a _e Radial Depth (mm)
4020-03-06	2	R0.3	30,000	7,650	0.03	0.41	10,000	2,160	0.08	0.36	8,000	1,170	0.04	0.36
4020-05-06		R0.5	30,000	7,650	0.05	0.72	10,000	2,160	0.14	0.63	8,000	1,170	0.07	0.63
4030-08-09	3	R0.8	25,000	8,100	0.07	1.08	10,000	2,970	0.16	0.95	7,000	1,710	0.09	0.95
4040-03-12-6		R0.3	15,000	8,550	0.05	0.66	9,000	3,600	0.08	0.62	6,000	2,160	0.04	0.62
4040-05-12	4	R0.5	15,000	8,550	0.06	0.82	9,000	3,600	0.1	0.77	6,000	2,160	0.05	0.77
4040-10-12		R1	15,000	8,550	0.11	1.44	9,000	3,600	0.16	1.35	6,000	2,160	0.09	1.35
4050-12-15	5	R1.2	10,000	8,550	0.16	1.8	8,000	4,950	0.18	1.58	6,000	2,160	0.14	1.58
4060-03-18		R0.3	9,000	8,550	0.08	0.98	8,000	5,400	0.09	0.87	6,000	2,070	0.08	0.87
4060-05-18	6	R0.5	9,000	8,550	0.1	1.23	8,000	5,400	0.11	1.08	6,000	2,070	0.11	1.08
4060-10-18		R1	9,000	8,550	0.14	1.57	8,000	5,400	0.14	1.49	6,000	2,070	0.14	1.49
4060-15-18	8	R1.5	9,000	8,550	0.17	2.16	8,000	5,400	0.18	1.89	6,000	2,070	0.18	1.89
4060-20-18		R2	9,000	8,550	0.17	2.3	8,000	5,400	0.18	2.02	6,000	2,070	0.18	2.02
4080-03-24	8	R0.3	7,000	8,550	0.03	1.2	6,000	5,850	0.04	1.04	4,000	2,070	0.03	1.04
4080-05-24		R0.5	7,000	8,550	0.04	1.5	6,000	5,850	0.05	1.3	4,000	2,070	0.04	1.3
4080-10-24	8	R1	7,000	8,550	0.05	1.92	6,000	5,850	0.06	1.8	4,000	2,070	0.05	1.8
4080-20-24		R2	7,000	8,550	0.21	2.88	6,000	5,850	0.23	2.52	4,000	2,070	0.18	2.52
4080-30-24	10	R3	7,000	8,550	0.21	3.09	6,000	5,850	0.23	2.7	4,000	2,070	0.18	2.7
4100-03-30		R0.3	6,000	8,550	0.03	1.6	5,000	5,580	0.04	1.3	3,000	2,160	0.03	1.3
4100-05-30	10	R0.5	6,000	8,550	0.04	2	5,000	5,580	0.05	1.62	3,000	2,160	0.04	1.62
4100-10-30		R1	6,000	8,550	0.06	2.57	5,000	5,580	0.07	2.25	3,000	2,160	0.05	2.25
4100-20-30	12	R2	6,000	8,550	0.24	3.6	5,000	5,580	0.27	3.15	3,000	2,160	0.18	3.15
4100-30-30		R3	6,000	8,550	0.24	3.86	5,000	5,580	0.27	3.38	3,000	2,160	0.18	3.38
4120-03-36	12	R0.3	5,000	8,550	0.04	1.93	4,000	7,290	0.04	1.56	2,000	2,250	0.03	1.56
4120-05-36		R0.5	5,000	8,550	0.05	2.41	4,000	7,290	0.05	1.94	2,000	2,250	0.04	1.94
4120-10-36	12	R1	5,000	8,550	0.07	3.09	4,000	7,290	0.07	2.7	2,000	2,250	0.05	2.7
4120-20-36		R2	5,000	8,550	0.27	4.32	4,000	7,290	0.27	3.78	2,000	2,250	0.18	3.78
4120-40-36	R4	5,000	8,550	0.27	4.63	4,000	7,290	0.27	4.05	2,000	2,250	0.18	4.05	

When using an effective length of 5D, or the protruding tool experiences an "overhang", then pay attention to the tool overhang coefficient below while referring to the milling parameter table.

*Effective Length 5D: Effective Length (ℓ) ÷ Diameter (φD) = 5

D: φ2.0~3.0

Overhang Length L/D	Spindle Speed (min ⁻¹)	Feed Rate (mm/min)	Axial Depth (mm)	Radial Depth (mm)
~φD×6	×1	×1	×1	×1
~φD×7	×0.8	×0.8	×0.8	×0.9
~φD×8	×0.7	×0.7	×0.7	×0.9
~φD×9	×0.7	×0.7	×0.6	×0.8
~φD×10	×0.6	×0.6	×0.6	×0.7

D: φ8.0~12.0

Overhang Length L/D	Spindle Speed (min ⁻¹)	Feed Rate (mm/min)	Axial Depth (mm)	Radial Depth (mm)
~φD×4	×1	×1	×1	×1
~φD×5	×0.7	×0.7	×0.7	×0.8
~φD×6	×0.5	×0.5	×0.6	×0.7

D: φ4.0~6.0

Overhang Length L/D	Spindle Speed (min ⁻¹)	Feed Rate (mm/min)	Axial Depth (mm)	Radial Depth (mm)
~φD×4	×1	×1	×1	×1
~φD×5	×0.9	×0.9	×0.9	×0.9
~φD×6	×0.8	×0.8	×0.8	×0.9
~φD×7	×0.7	×0.7	×0.6	×0.8
~φD×8	×0.5	×0.5	×0.6	×0.7

D: Outside Diameter (mm) L: Overhang Length (mm)

Milling Conditions for HRRS / HRRS-S

◆ Finishing (flat / inclined surface) Effective length 3D

WORK MATERIAL			PREHARDENED STEELS / HARDENED STEELS (30~45HRC) (Air Blow / Oil Mist)				HARDENED STEELS (45~55HRC) (Air Blow / Oil Mist)				HARDENED STEELS (55~65HRC) (Air Blow / Oil Mist)			
Model Number	Outside Diameter (mm)	Corner Radius (mm)	Spindle Speed (min ⁻¹)	Feed Rate (mm/min)	a_p Axial Depth (mm)	a_e Radial Depth (mm)	Spindle Speed (min ⁻¹)	Feed Rate (mm/min)	a_p Axial Depth (mm)	a_e Radial Depth (mm)	Spindle Speed (min ⁻¹)	Feed Rate (mm/min)	a_p Axial Depth (mm)	a_e Radial Depth (mm)
4020-03-06	2	R0.3	30,000	850	0.1	0.03	10,000	355	0.1	0.04	8,000	240	0.05	0.03
4020-05-06		R0.5	30,000	1,100	0.1	0.04	10,000	460	0.1	0.05	8,000	310	0.05	0.04
4030-08-09	3	R0.8	25,000	1,100	0.1	0.04	10,000	650	0.1	0.07	7,000	350	0.05	0.05
4040-03-12-6		R0.3	15,000	620	0.08	0.04	9,000	365	0.08	0.04	6,000	205	0.04	0.03
4040-05-12	4	R0.5	15,000	775	0.1	0.05	9,000	455	0.1	0.05	6,000	255	0.05	0.04
4040-10-12		R1	15,000	1,100	0.1	0.07	9,000	650	0.1	0.07	6,000	360	0.05	0.06
4050-12-15	5	R1.2	10,000	1,100	0.1	0.11	8,000	650	0.1	0.08	6,000	360	0.05	0.06
4060-03-18		R0.3	9,000	550	0.16	0.06	8,000	300	0.16	0.04	6,000	170	0.08	0.03
4060-05-18	6	R0.5	9,000	690	0.2	0.08	8,000	375	0.2	0.05	6,000	215	0.1	0.04
4060-10-18		R1	9,000	975	0.2	0.11	8,000	530	0.2	0.07	6,000	310	0.1	0.05
4060-15-18		R1.5	9,000	1,200	0.2	0.13	8,000	650	0.2	0.08	6,000	380	0.1	0.06
4060-20-18		R2	9,000	1,385	0.2	0.15	8,000	750	0.2	0.09	6,000	435	0.1	0.07
4080-03-24	8	R0.3	7,000	480	0.04	0.07	6,000	260	0.04	0.05	4,000	145	0.04	0.05
4080-05-24		R0.5	7,000	598	0.05	0.09	6,000	322	0.05	0.06	4,000	184	0.05	0.06
4080-10-24		R1	7,000	845	0.05	0.12	6,000	455	0.05	0.08	4,000	265	0.05	0.07
4080-20-24		R2	7,000	1,200	0.2	0.17	6,000	650	0.2	0.11	4,000	380	0.1	0.1
4080-30-24	10	R3	7,000	1,465	0.2	0.21	6,000	795	0.2	0.13	4,000	465	0.1	0.12
4100-03-30		R0.3	6,000	478	0.04	0.08	5,000	258	0.04	0.05	3,000	147	0.04	0.06
4100-05-30		R0.5	6,000	598	0.05	0.1	5,000	322	0.05	0.06	3,000	184	0.05	0.07
4100-10-30		R1	6,000	845	0.05	0.14	5,000	455	0.05	0.09	3,000	265	0.05	0.09
4100-20-30	12	R2	6,000	1,200	0.2	0.2	5,000	650	0.2	0.13	3,000	380	0.1	0.13
4100-30-30		R3	6,000	1,470	0.2	0.25	5,000	795	0.2	0.16	3,000	465	0.1	0.16
4120-03-36		R0.3	5,000	480	0.04	0.1	4,000	260	0.04	0.07	2,000	145	0.04	0.09
4120-05-36		R0.5	5,000	598	0.05	0.12	4,000	322	0.05	0.08	2,000	184	0.05	0.1
4120-10-36	12	R1	5,000	845	0.05	0.17	4,000	455	0.05	0.11	2,000	265	0.05	0.13
4120-20-36		R2	5,000	1,200	0.2	0.24	4,000	650	0.2	0.16	2,000	380	0.1	0.19
4120-40-36		R4	5,000	1,695	0.2	0.34	4,000	915	0.2	0.23	2,000	535	0.1	0.27

When using an effective length of 5D, or the protruding tool experiences an "overhang", then pay attention to the tool overhang coefficient found on page 384 while referring to the milling parameter table.

*Effective Length 5D: Effective Length (ℓ_e) ÷ Diameter (ϕD) = 5

Roughing Parameter

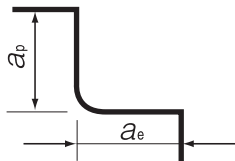

Finishing Parameter (Flat / Inclined Surface)

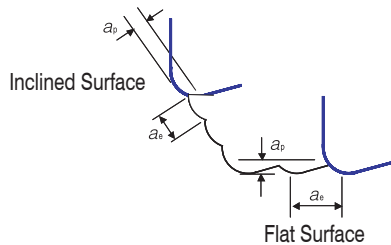

Note:

- Decrease both spindle speed and feed rate proportionally when the milling parameters exceed the machine's maximum spindle speed.
- Decrease the feed rate more than 50% from the milling parameters when slot milling.
- Only adjust the spindle speed when calculate milling conditions based on the overhang length in finishing process.
- Recommend air blow or oil mist.

4 Flutes

Ø3mm Shank V Series

UDC-PCD Series

CBN Series

Square

Long Neck Square

Radius

Long Neck Radius

Taper Neck Radius

Ball / Long Shank Ball

Long Neck Ball

Taper Neck Ball

Taper

Barrel

Spiral V Cutter

Drill

Technical Data

Flat Milling Example: Milling with HRRS $\phi 12 \times \text{CR4}$

SKD11 (60HRC)

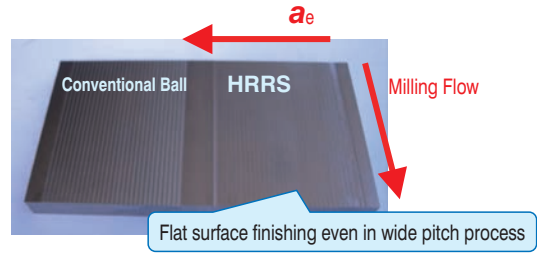
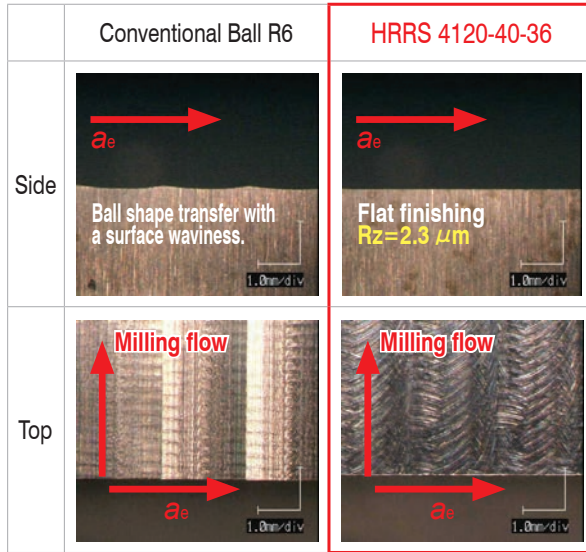

HRRS Surface Roughness
Maximum Surface Roughness (calculated value) = $2.375 \mu\text{m}$

Spindle Speed	Feed Rate	a_p	a_e	Milling Distance	Overhang Length
$2,000 \text{ min}^{-1}$	535 mm/min	0.1 mm	2 mm	100 mm \times 35 Times	55 mm

HRRS Series
NAK80 (40HRC)
Milling Video



HRRS Series
DH31S (52HRC)
Milling Video







HRRS Series
DH31 (52HRC)
Milling Video

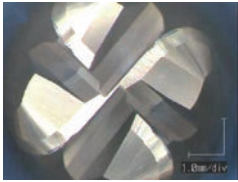
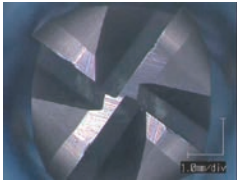
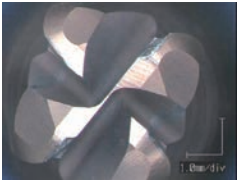
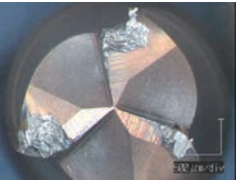
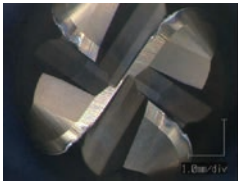

- 3mm Shank V Series
- UDC-PCD Series
- CBN Series
- Square
- Long Neck Square
- Radius
- Long Neck Radius
- Taper Neck Radius
- Ball / Long Shank Ball
- Long Neck Ball
- Taper Neck Ball
- Taper
- Barrel
- Spiral V Cutter
- Drill
- Technical Data

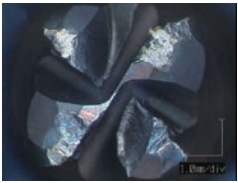
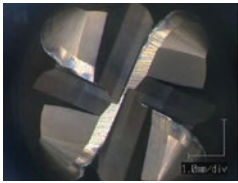
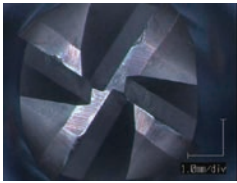
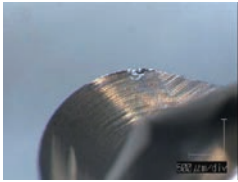
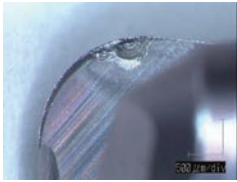
Pocket Milling Example: Milling with HRRS $\phi 6 \times \text{CR1.5}$ SKD11 (60HRC)

	HRRS	Competitor A: 4 Flutes	Competitor B: 4 Flutes	Competitor B: 3 Flutes
Depth 0.9 mm				
Depth 12.3 mm				Broken
Depth 16.5 mm			Broken	
			 Pocket Milling Cycle Time: 40 min	

Spindle Speed	Z helical Approach	Feed Rate	a_p	a_e	Overhang Length	Cycle Time	Coolant
2,700 min^{-1}	1,350 mm/min	2,000 mm/min	0.3 mm (0.05D)	1.5 mm (0.25D)	20 mm	40 min	Air Blow (Nozzle)

Longer tool life on 60HRC milling.

4 Flutes

$\phi 3\text{mm}$ Shank V Series

UDC-PCD Series

CBN Series

Square

Long Neck Square

Radius

Long Neck Radius

Taper Neck Radius

Ball / Long Shank Ball

Long Neck Ball

Taper Neck Ball

Taper

Barrel

Spiral V Cutter

Drill

Technical Data



Size $\phi 2 \sim \phi 12$

Short Shank Series

HRRS-S

Super MG
HARD MAX
45°
R
 ± 0.01
 ± 0.015
Shank Dia 0/-0.005
Back Taper Geometry
Variable Pitch

$\phi 2 \sim \phi 6$ $\phi 8 \sim \phi 12$

Material Applications (★ Highly Recommended ● Recommended ○ Suggested)

Work Material																	
Carbon Steels	Alloy Steels	Prehardened Steels	Hardened Steels					Cast Iron	Aluminum Alloys	Graphite	Copper	Plastics	Glass Filled Plastics	Titanium Alloys	Heat Resistant Alloys	Cemented Carbide	Hard Brittle (Non-Metallic) Materials
			~50HRC	~55HRC	~60HRC	~65HRC	~70HRC										
S45C S55C	SK / SCM SUS	NAK HPM	●	●	●	●	○	○									

Features

Shorter overall length and overhang offer higher feed and precision.

Achieves larger step over by seamless corner radius design.

Rated to 65HRC milling. Refer to page 384, 385 for milling conditions.

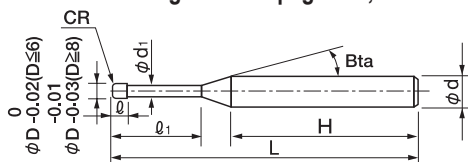

The shank taper angle and the shank length (H) shown are not an exact value and to avoid contact with the work piece, we recommend the user controls the precise value of this angle. Shank taper angle should not make contact with the work piece.

Total 26 models

Unit (mm)

Model Number	Outside Diameter ϕD	Corner Radius CR	Effective Length ℓ_1	Length of Cut ℓ	Neck Diameter ϕd_1	Shank Taper Angle Bta	Overall Length L	Shank Diameter ϕd	Shank Length H	Suggested Retail Price ¥
HRRS 4020-03-06S	2	R0.3	6	2	1.91	16°	45	4	33.0	9,450
HRRS 4020-05-06S		R0.5					45			
HRRS 4030-08-09-3S	3	R0.8	9	3	2.92	16°	50	3	38.5	8,820
HRRS 4030-08-09S							50			
HRRS 4040-05-12S	4	R0.5	12	4	3.82	16°	50	4	35.0	9,000
HRRS 4040-05-12-6S							50			
HRRS 4040-10-12S		R1					50	4	35.0	9,000
HRRS 4040-10-12-6S							50			
HRRS 4050-12-15S	5	R1.2	15	5	4.82	16°	50	6	30.0	10,800
HRRS 4060-05-18S	6	R0.5	18	6	5.82	—	50	6	29.0	12,060
HRRS 4060-10-18S		R1					50			
HRRS 4060-15-18S		R1.5					50	6	29.0	12,060
HRRS 4060-20-18S		R2					50			
HRRS 4080-05-24S	8	R0.5	24	8	7.82	—	60	8	33.0	15,030
HRRS 4080-10-24S		R1					60			
HRRS 4080-20-24S		R2					60	8	33.0	15,030
HRRS 4080-30-24S		R3					60			
HRRS 4100-03-30S	10	R0.3	30	10	9.82	—	65	10	31.5	19,800
HRRS 4100-05-30S		R0.5					65			
HRRS 4100-10-30S		R1					65	10	31.5	19,800
HRRS 4100-20-30S		R2					65			
HRRS 4100-30-30S	R3	65	10	31.5	19,800					
HRRS 4120-05-36S	12	R0.5	36	12	11.82	—	75	12	35.5	24,930
HRRS 4120-10-36S		R1					75			
HRRS 4120-20-36S		R2					75	12	35.5	24,930
HRRS 4120-40-36S		R4					75			

Pocket Milling Example: Milling with HRRS $\phi 6 \times CR1.5$

NAK80 (40HRC)

4 Flutes

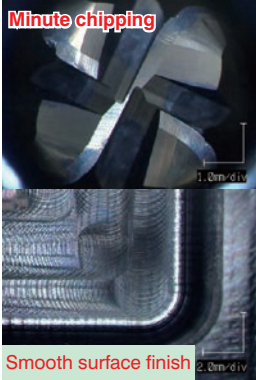
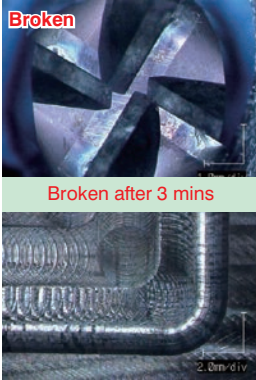
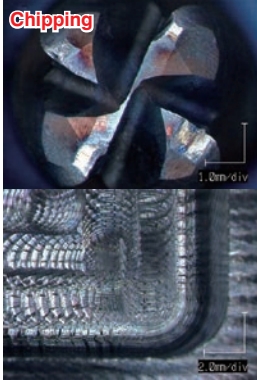
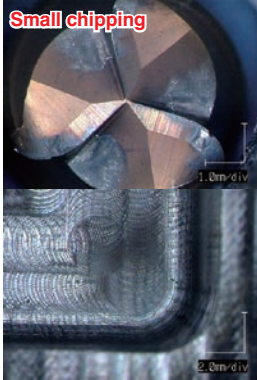
HRRS	Competitor A: 4 Flutes	Competitor B: 4 Flutes	Competitor B: 3 Flutes
			
CR1.5, FL6 mm, EFL18 mm	CR1.5, FL6 mm, EFL18 mm	CR1.5, FL12 mm	CR1.5, FL12 mm

Spindle Speed	Feed Rate	a_p	a_e	Overhang Length	Cycle Time	Pocket Size
9,000 min ⁻¹	11,000 mm/min	0.3 mm (0.05D)	3 mm (0.5D)	20 mm	20 min	40 × 180 × Depth 15 mm

Excellent chipping resistance and surface quality !

Original corner radius design offers high rigidity and reduces cutting resistance.

After milling SKD11 (60HRC)

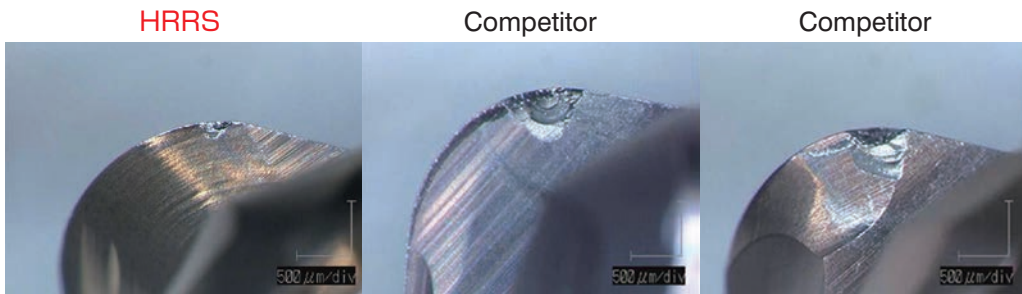

Seamless corner radius with equal rake angle design. Reduces the cutting resistance and offers excellent chip evacuation to protect from the tool damage.

Flat and non-helix gash design. Badly damaged at tip point where cutting chips are trapped by poor chip evacuation.

Flat and helical gash design. Huge tool damage at tangent point where the gash shape abruptly changed and cutting chips could not evacuate properly.

Spindle Speed	Feed Rate	a_p	a_e	Overhang Length	Pocket Size
2,700 min ⁻¹	2,000 mm/min	0.3 mm	1.5 mm	20 mm	40 × 40 × 0.3 mm

Longer tool life with variable pitch design. Recommended for various coolant.

- $\phi 3$ mm Shank V Series
- UDC-PCD Series
- CBN Series
- Square
- Long Neck Square
- Radius
- Long Neck Radius
- Taper Neck Radius
- Ball / Long Shank Ball
- Long Neck Ball
- Taper Neck Ball
- Taper
- Barrel
- Spiral V Cutter
- Drill
- Technical Data



Size $\phi 2 \sim \phi 12$

CRRS



$\phi 2 \sim \phi 6$ $\phi 8 \sim \phi 12$

Material Applications (★ Highly Recommended ● Recommended ○ Suggested)

Work Material																	
Carbon Steels S45C S55C	Alloy Steels SK / SCM SUS	Prehardened Steels NAK HPM	Hardened Steels					Cast Iron	Aluminum Alloys	Graphite	Copper	Plastics	Glass Filled Plastics	Titanium Alloys	Heat Resistant Alloys	Cemented Carbide	Hard Brittle (Non-Metallic) Materials
			~50HRC	~55HRC	~60HRC	~65HRC	~70HRC										
●	●	●	●	●				○	○		●			●	●		

Features

Broad application range from Copper and Raw Materials to Hardened Steels (55HRC). UTCOAT offers long tool life. Variable pitch, high helix and positive rake angle offer stable milling. Reduced cutting resistance when using a helical approach or inclined angles.

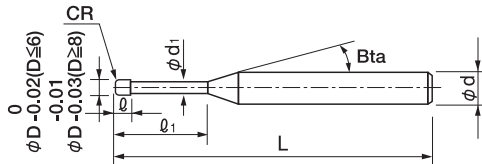

The shank taper angle shown is not an exact value and to avoid contact with the work piece, we recommend the user controls the precise value of this angle. Shank taper angle should not make contact with the work piece.

Total 24 models

Unit (mm)

Model Number	Outside Diameter ϕD	Corner Radius CR	Effective Length ℓ_1	Length of Cut ℓ	Neck Diameter ϕd_1	Shank Taper Angle Bta	Overall Length L	Shank Diameter ϕd	Suggested Retail Price ¥				
CRRS 4020-05-06	2	RO.5	6	2	1.91	16°	70	4	10,500				
CRRS 4030-08-09	3	RO.8	9	3	2.92	16°	70	6	10,800				
CRRS 4040-03-12	4	RO.3	12	4	3.82	16°	60	6	11,600				
CRRS 4040-05-12-4		RO.5				—	70	4	10,000				
CRRS 4040-05-12		R1				16°	60	6	11,600				
CRRS 4040-10-12-4						—	70	4	10,000				
CRRS 4040-10-12	5	R1	15	5	4.82	16°	70	6	11,600				
CRRS 4050-12-15						16°	70	6	12,000				
CRRS 4060-03-18						RO.3	18	6	5.82	—	90	6	13,400
CRRS 4060-05-18						RO.5					60	6	13,400
CRRS 4060-10-18	R1	60	6	13,400									
CRRS 4060-15-18	R1.5	90	6	13,400									
CRRS 4080-03-24	8	RO.3	24	8	7.82	—	100	8	16,700				
CRRS 4080-05-26		RO.5	26				70	8	16,700				
CRRS 4080-10-26		R1	26				70	8	16,700				
CRRS 4080-20-24		R2	24				100	8	16,700				
CRRS 4100-03-30	10	RO.3	30	10	9.82	—	110	10	22,000				
CRRS 4100-05-30		RO.5					80	10	22,000				
CRRS 4100-10-30		R1					80	10	22,000				
CRRS 4100-20-30		R2					110	10	22,000				
CRRS 4120-03-36	12	RO.3	36	12	11.82	—	120	12	27,700				
CRRS 4120-05-36		RO.5					120	12	27,700				
CRRS 4120-10-36		R1					120	12	27,700				
CRRS 4120-20-36		R2					120	12	27,700				

Milling Conditions for CRRS

◆ Roughing

WORK MATERIAL			CARBON STEELS S45C / S55C (~225HB)				ALLOY STEELS SK / SCM / SUS(225~325HB) *Use cutting oils for Stainless Steels.				PREHARDENED STEELS HARDENED STEELS NAK / HPM / SKD / SKT / STAVAX(30~55HRC) *Recommend oil mist.				
Model Number	Outside Diameter (mm)	Corner Radius (mm)	Spindle Speed (min ⁻¹)	Feed Rate (mm/min)	a _p Axial Depth (mm)	a _e Radial Depth (mm)	Spindle Speed (min ⁻¹)	Feed Rate (mm/min)	a _p Axial Depth (mm)	a _e Radial Depth (mm)	Spindle Speed (min ⁻¹)	Feed Rate (mm/min)	a _p Axial Depth (mm)	a _e Radial Depth (mm)	
4020-05-06	2	R0.5	30,000	7,200	0.08	0.8	30,000	7,200	0.04	0.66	24,000	7,000	0.02	0.59	
4030-08-09	3	R0.8	20,000	8,400	0.09	1.2	20,000	7,200	0.04	1.08	16,000	7,000	0.04	0.88	
4040-03-12	4	R0.3	15,000	9,600	0.09	1.6	15,000	7,200	0.05	1.32	12,000	7,000	0.05	1.17	
4040-05-12-4		R0.5	15,000	9,600	0.1	1.6	15,000	7,200	0.05	1.35	12,000	7,000	0.05	1.26	
4040-05-12			15,000	9,600	0.1	1.6	15,000	7,200	0.05	1.35	12,000	7,000	0.05	1.26	
4040-10-12-4			R1	15,000	9,600	0.11	1.6	15,000	7,200	0.05	1.53	12,000	7,000	0.06	1.33
4040-10-12				15,000	9,600	0.11	1.6	15,000	7,200	0.05	1.53	12,000	7,000	0.06	1.33
4050-12-15	5	R1.2	12,000	10,800	0.13	2	12,000	7,200	0.06	1.8	9,600	6,300	0.06	1.54	
4060-03-18	6	R0.3	10,000	12,000	0.13	2.4	10,000	7,200	0.07	1.94	8,000	5,250	0.07	1.63	
4060-05-18		R0.5	10,000	12,000	0.14	2.4	10,000	7,200	0.07	1.98	8,000	5,250	0.07	1.75	
4060-10-18		R1	10,000	12,000	0.15	2.4	10,000	7,200	0.07	2.16	8,000	5,250	0.08	1.75	
4060-15-18		R1.5	10,000	12,000	0.17	2.4	10,000	7,200	0.08	2.34	8,000	5,250	0.11	1.75	
4080-03-24		R0.3	7,500	12,000	0.17	2.86	7,500	7,200	0.08	2.76	6,000	4,100	0.15	1.77	
4080-05-26	8	R0.5	7,500	12,000	0.18	2.64	7,500	7,200	0.08	2.61	6,000	4,100	0.14	1.76	
4080-10-26		R1	7,500	12,000	0.18	2.72	7,500	7,200	0.09	2.7	6,000	4,100	0.16	1.76	
4080-20-24		R2	7,500	12,000	0.22	2.88	7,500	7,200	0.1	2.79	6,000	4,100	0.18	1.96	
4100-03-30	10	R0.3	6,000	12,000	0.2	3.04	5,000	5,400	0.14	2.82	4,800	4,100	0.18	1.89	
4100-05-30		R0.5	6,000	12,000	0.22	3.04	5,000	5,400	0.14	2.88	4,800	4,100	0.18	2.03	
4100-10-30		R1	6,000	12,000	0.24	3.28	5,000	5,400	0.14	2.97	4,800	4,100	0.19	2.1	
4100-20-30		R2	6,000	12,000	0.26	3.44	5,000	5,400	0.14	3.06	4,800	4,100	0.2	2.45	
4120-03-36		12	R0.3	5,000	12,000	0.21	3.32	3,000	4,320	0.18	2.9	4,000	4,100	0.19	2.15
4120-05-36	R0.5		5,000	12,000	0.24	3.32	3,000	4,320	0.18	2.96	4,000	4,100	0.19	2.32	
4120-10-36	R1		5,000	12,000	0.26	3.59	3,000	4,320	0.18	3.06	4,000	4,100	0.2	2.4	
4120-20-36	R2		5,000	12,000	0.28	3.76	3,000	4,320	0.18	3.15	4,000	4,100	0.21	2.8	

WORK MATERIAL			TITANIUM / TITANIUM ALLOYS Ti-6Al-4V				HEAT RESISTANT ALLOYS Inconel718				
Model Number	Outside Diameter (mm)	Corner Radius (mm)	Spindle Speed (min ⁻¹)	Feed Rate (mm/min)	a _p Axial Depth (mm)	a _e Radial Depth (mm)	Spindle Speed (min ⁻¹)	Feed Rate (mm/min)	a _p Axial Depth (mm)	a _e Radial Depth (mm)	
4020-05-06	2	R0.5	21,420	4,010	0.03	0.33	5,140	810	0.03	0.33	
4030-08-09	3	R0.8	14,280	4,010	0.03	0.54	3,430	810	0.03	0.54	
4040-03-12	4	R0.3	10,710	4,010	0.04	0.66	2,570	810	0.04	0.66	
4040-05-12-4		R0.5	10,710	4,010	0.04	0.68	2,570	810	0.04	0.68	
4040-05-12			10,710	4,010	0.04	0.68	2,570	810	0.04	0.68	
4040-10-12-4			R1	10,710	4,010	0.04	0.77	2,570	810	0.04	0.77
4040-10-12				10,710	4,010	0.04	0.77	2,570	810	0.04	0.77
4050-12-15	5	R1.2	8,570	4,010	0.04	0.9	2,060	810	0.04	0.9	
4060-03-18	6	R0.3	7,140	4,010	0.05	1	1,740	810	0.05	1	
4060-05-18		R0.5	7,140	4,010	0.05	1	1,740	810	0.05	1	
4060-10-18		R1	7,140	4,010	0.05	1.08	1,740	810	0.05	1.08	
4060-15-18		R1.5	7,140	4,010	0.05	1.08	1,740	810	0.05	1.08	
4080-03-24		R0.3	5,360	4,000	0.05	1.28	1,580	800	0.05	1.28	
4080-05-26	8	R0.5	5,360	4,000	0.05	1.31	1,580	800	0.05	1.31	
4080-10-26		R1	5,360	4,000	0.05	1.35	1,580	800	0.05	1.35	
4080-20-24		R2	5,360	4,000	0.05	1.4	1,580	800	0.05	1.4	
4100-03-30	10	R0.3	3,570	3,010	0.09	1.41	1,050	550	0.09	1.41	
4100-05-30		R0.5	3,570	3,010	0.09	1.44	1,050	550	0.09	1.44	
4100-10-30		R1	3,570	3,010	0.09	1.49	1,050	550	0.09	1.49	
4100-20-30		R2	3,570	3,010	0.09	1.53	1,050	550	0.09	1.53	
4120-03-36		12	R0.3	2,140	2,400	0.12	1.45	640	410	0.12	1.45
4120-05-36	R0.5		2,140	2,400	0.12	1.48	640	410	0.12	1.48	
4120-10-36	R1		2,140	2,400	0.12	1.53	640	410	0.12	1.53	
4120-20-36	R2		2,140	2,400	0.12	1.58	640	410	0.12	1.58	

4 Flutes

- Ø3mm Shank V Series
- UDC-PCD Series
- CBN Series
- Square
- Long Neck Square
- Radius
- Long Neck Radius
- Taper Neck Radius
- Ball / Long Shank Ball
- Long Neck Ball
- Taper Neck Ball
- Taper
- Barrel
- Spiral V Cutter
- Drill
- Technical Data

Milling Conditions for CRRS

◆Finishing (Flat / Inclined surface)

WORK MATERIAL			CARBON STEELS S45C / S55C (~225HB)				ALLOY STEELS SK / SCM / SUS(225~325HB) *Use cutting oils for Stainless Steels.				PREHARDENED STEELS HARDENED STEELS NAK / HPM / SKD / SKT / STAVAX(30~55HRC) *Recommend oil mist.			
Model Number	Outside Diameter (mm)	Corner Radius (mm)	Spindle Speed (min ⁻¹)	Feed Rate (mm/min)	a _p Axial Depth (mm)	a _e Radial Depth (mm)	Spindle Speed (min ⁻¹)	Feed Rate (mm/min)	a _p Axial Depth (mm)	a _e Radial Depth (mm)	Spindle Speed (min ⁻¹)	Feed Rate (mm/min)	a _p Axial Depth (mm)	a _e Radial Depth (mm)
4020-05-06	2	R0.5	30,000	1,720	0.1	0.06	30,000	1,510	0.05	0.05	24,000	1,070	0.05	0.04
4030-08-09	3	R0.8	20,000	1,890	0.1	0.09	20,000	1,660	0.05	0.08	16,000	1,160	0.05	0.07
4040-03-12	4	R0.3	15,000	1,050	0.1	0.07	15,000	910	0.05	0.06	12,000	620	0.05	0.05
4040-05-12-4		R0.5	15,000	1,360	0.1	0.09	15,000	1,180	0.05	0.08	12,000	810	0.05	0.07
4040-05-12		R1	15,000	1,360	0.1	0.09	15,000	1,180	0.05	0.08	12,000	810	0.05	0.07
4040-10-12-4			15,000	1,920	0.1	0.13	15,000	1,670	0.05	0.11	12,000	1,150	0.05	0.1
4040-10-12			15,000	1,920	0.1	0.13	15,000	1,670	0.05	0.11	12,000	1,150	0.05	0.1
4050-12-15	5	R1.2	12,000	1,910	0.1	0.16	12,000	1,630	0.05	0.14	9,600	1,120	0.05	0.12
4060-03-18	6	R0.3	10,000	890	0.2	0.09	10,000	760	0.1	0.08	8,000	510	0.1	0.06
4060-05-18		R0.5	10,000	1,150	0.2	0.12	10,000	990	0.1	0.1	8,000	670	0.1	0.08
4060-10-18		R1	10,000	1,630	0.2	0.16	10,000	1,400	0.1	0.14	8,000	950	0.1	0.12
4060-15-18		R1.5	10,000	2,000	0.2	0.2	10,000	1,720	0.1	0.17	8,000	1,170	0.1	0.15
4080-03-24		R0.3	7,500	1,170	0.2	0.11	7,500	1,050	0.1	0.09	6,000	720	0.1	0.08
4080-05-26	8	R0.5	7,500	990	0.2	0.13	7,500	860	0.1	0.11	6,000	580	0.1	0.1
4080-10-26		R1	7,500	1,410	0.2	0.19	7,500	1,210	0.1	0.16	6,000	830	0.1	0.14
4080-20-24		R2	7,500	1,990	0.2	0.27	7,500	1,720	0.1	0.23	6,000	1,170	0.1	0.2
4100-03-30	10	R0.3	6,000	720	0.2	0.12	5,000	510	0.1	0.1	4,800	400	0.1	0.08
4100-05-30		R0.5	6,000	940	0.2	0.16	5,000	660	0.1	0.13	4,800	520	0.1	0.11
4100-10-30		R1	6,000	1,330	0.2	0.22	5,000	940	0.1	0.19	4,800	740	0.1	0.15
4100-20-30		R2	6,000	1,890	0.2	0.32	5,000	1,340	0.1	0.27	4,800	1,050	0.1	0.22
4120-03-36		12	R0.3	5,000	680	0.2	0.14	3,000	330	0.1	0.1	4,000	360	0.1
4120-05-36	R0.5		5,000	880	0.2	0.18	3,000	430	0.1	0.14	4,000	480	0.1	0.12
4120-10-36	R1		5,000	1,240	0.2	0.24	3,000	610	0.1	0.2	4,000	680	0.1	0.16
4120-20-36	R2		5,000	1,760	0.2	0.35	3,000	870	0.1	0.29	4,000	960	0.1	0.24

WORK MATERIAL			TITANIUM / TITANIUM ALLOYS Ti-6Al-4V				HEAT RESISTANT ALLOYS Inconel718			
Model Number	Outside Diameter (mm)	Corner Radius (mm)	Spindle Speed (min ⁻¹)	Feed Rate (mm/min)	a _p Axial Depth (mm)	a _e Radial Depth (mm)	Spindle Speed (min ⁻¹)	Feed Rate (mm/min)	a _p Axial Depth (mm)	a _e Radial Depth (mm)
4020-05-06	2	R0.5	21,420	840	0.04	0.03	5,140	170	0.04	0.03
4030-08-09	3	R0.8	14,280	920	0.04	0.04	3,430	190	0.04	0.04
4040-03-12	4	R0.3	10,710	510	0.04	0.03	2,570	100	0.04	0.03
4040-05-12-4		R0.5	10,710	660	0.04	0.04	2,570	130	0.04	0.04
4040-05-12			10,710	660	0.04	0.04	2,570	130	0.04	0.04
4040-10-12-4			R1	10,710	930	0.04	0.06	2,570	190	0.04
4040-10-12		10,710		930	0.04	0.06	2,570	190	0.04	0.06
4050-12-15	5	R1.2	8,570	910	0.03	0.07	2,060	180	0.03	0.07
4060-03-18	6	R0.3	7,140	420	0.07	0.04	1,740	90	0.07	0.04
4060-05-18		R0.5	7,140	550	0.07	0.05	1,740	110	0.07	0.05
4060-10-18		R1	7,140	780	0.07	0.07	1,740	160	0.07	0.07
4060-15-18		R1.5	7,140	960	0.06	0.08	1,740	190	0.06	0.08
4080-03-24		R0.3	5,360	400	0.06	0.04	1,580	80	0.06	0.04
4080-05-26	8	R0.5	5,360	480	0.06	0.06	1,580	100	0.06	0.06
4080-10-26		R1	5,360	670	0.06	0.08	1,580	130	0.06	0.08
4080-20-24		R2	5,360	960	0.05	0.12	1,580	190	0.05	0.12
4100-03-30	10	R0.3	3,570	280	0.06	0.05	1,050	50	0.06	0.05
4100-05-30		R0.5	3,570	370	0.06	0.07	1,050	70	0.06	0.07
4100-10-30		R1	3,570	520	0.06	0.1	1,050	100	0.06	0.1
4100-20-30		R2	3,570	750	0.06	0.14	1,050	140	0.06	0.14
4120-03-36		12	R0.3	2,140	240	0.07	0.05	640	40	0.07
4120-05-36	R0.5		2,140	310	0.07	0.07	640	50	0.07	0.07
4120-10-36	R1		2,140	400	0.07	0.11	640	70	0.07	0.12
4120-20-36	R2		2,140	520	0.07	0.17	640	100	0.07	0.17

Milling Conditions for CRRS

Please adjust milling parameter referring following table.

D : Outside Diameter (mm)

L : Overhang Length (mm)

D : $\phi 2.0 \sim 3.0$

Overhang Length L/D	Spindle Speed (min ⁻¹)	Feed Rate (mm/min)	a_p Axial Depth (mm)	a_e Radial Depth (mm)
L/D ≤ 6	× 1	× 1	× 1	× 1
L/D = 7	× 0.8	× 0.8	× 0.8	× 0.9
L/D = 8	× 0.7	× 0.7	× 0.7	× 0.9
L/D = 9	× 0.7	× 0.7	× 0.6	× 0.8
L/D = 10	× 0.6	× 0.6	× 0.6	× 0.7

D : $\phi 4.0 \sim 6.0$

Overhang Length L/D	Spindle Speed (min ⁻¹)	Feed Rate (mm/min)	a_p Axial Depth (mm)	a_e Radial Depth (mm)
L/D ≤ 4	× 1	× 1	× 1	× 1
L/D = 5	× 0.9	× 0.8	× 0.9	× 0.9
L/D = 6	× 0.8	× 0.7	× 0.8	× 0.9
L/D = 7	× 0.7	× 0.6	× 0.6	× 0.8
L/D = 8	× 0.5	× 0.4	× 0.6	× 0.7

D : $\phi 8.0 \sim 12.0$

Overhang Length L/D	Spindle Speed (min ⁻¹)	Feed Rate (mm/min)	a_p Axial Depth (mm)	a_e Radial Depth (mm)
L/D ≤ 4	× 1	× 1	× 1	× 1
L/D = 5	× 0.7	× 0.6	× 0.6	× 0.8
L/D = 6	× 0.5	× 0.4	× 0.5	× 0.7

Note:

- Decrease both spindle speed and feed rate proportionally when the milling parameters exceed the machine's maximum spindle speed.
- Decrease the feed rate more than 50% from the milling parameters when slot milling.
- Only adjust the spindle speed to calculate milling conditions based on the overhang length in finishing process.
- Every coolant offers stable milling.
- Recommend wet coolant for Stainless Steels.

Roughing Parameter

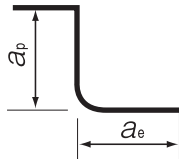

Finishing Parameter
(Flat / Inclined Surface)

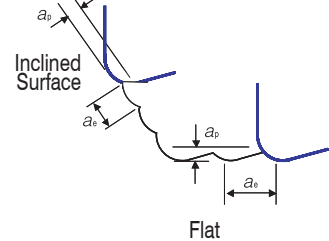

4 Flutes

$\phi 3$ mm Shank
V Series

UDC-PCD
Series

CBN
Series

Square

Square

Long Neck
Square

Radius

Radius

Radius

Long Neck
Radius

Taper Neck
Radius

Ball

Ball / Long
Shank Ball

Long Neck
Ball

Taper Neck
Ball

Taper

Taper

Barrel

Spiral
V Cutter

Drill

Technical Data

Tools After Milling by Different Work Materials CRRS $\phi 6 \times CRO.5$

Spindle Speed	Feed Rate	a_p	a_e	Overhang Length	Cycle Time	Coolant
10,000 min ⁻¹	12,000 mm/min	0.14 mm	2.4 mm	24 mm	90 min	Air Blow (Nozzle)

S50C

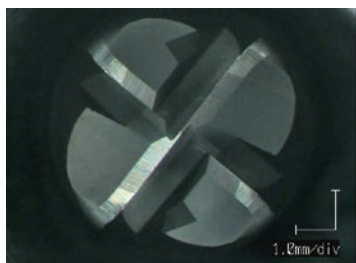

Relief Wear Width
0.070 mm

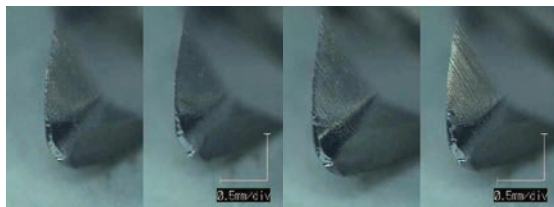

Spindle Speed	Feed Rate	a_p	a_e	Overhang Length	Cycle Time	Coolant
10,000 min ⁻¹	7,200 mm/min	0.07 mm	1.98 mm	24 mm	84 min	Water Soluble

SUS304

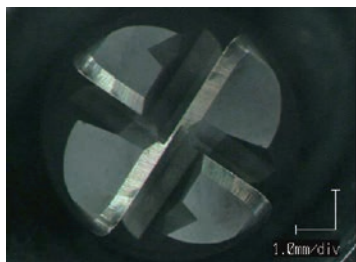

Relief Wear Width
0.032 mm

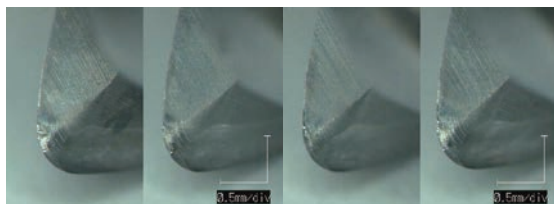

Spindle Speed	Feed Rate	a_p	a_e	Overhang Length	Cycle Time	Coolant
8,000 min ⁻¹	5,250 mm/min	0.07 mm	1.75 mm	24 mm	56 min	Oil Mist

STAVAX (52HRC)



Relief Wear Width
0.087 mm

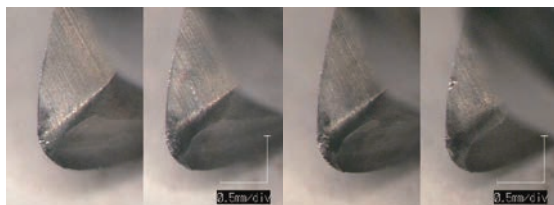

- φ3mm Shank V Series
- UDC-PCD Series
- CBN Series
- Square
- Long Neck Square
- Radius
- Long Neck Radius
- Taper Neck Radius
- Ball / Long Shank Ball
- Long Neck Ball
- Taper Neck Ball
- Taper
- Barrel
- Spiral V Cutter
- Drill
- Technical Data

CRRS $\phi 6 \times CR0.3$ Milling Example

Ti-6Al-4V

Spindle Speed	Feed Rate	a_p	a_e	Cycle Time	Coolant
$7,150 \text{ min}^{-1}$	4,000 mm/min	0.05 mm	1 mm	67 min	Water Soluble (Through-spindle)

Square pocket size $100 \times 25 \times 4 \text{ mm}$

No vibration and chattering. No burrs or chattering on workpiece. No tool damage and tool wear within normal range.

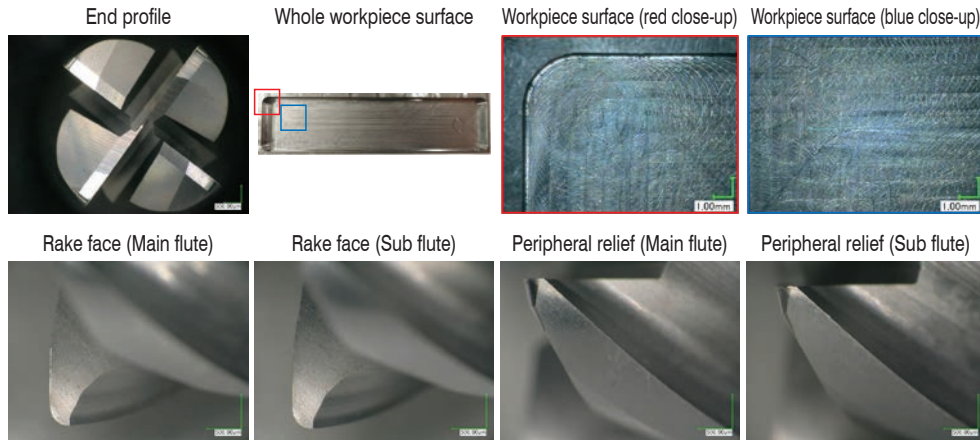

CRRS $\phi 6 \times CR1.5$ Milling Example

Inconel718

Spindle Speed	Feed Rate	a_p	a_e	Cycle Time	Coolant
$1,740 \text{ min}^{-1}$	820 mm/min	0.06 mm	1.1 mm	63 min	Water Soluble (Through-spindle)

Square pocket size $40 \times 30 \times 3 \text{ mm}$

No vibration and chattering. No burrs or chattering on workpiece. Chipping on rake face due to wear on the bottom cutting edge. Acceptable given the 60min milling of Inconel.

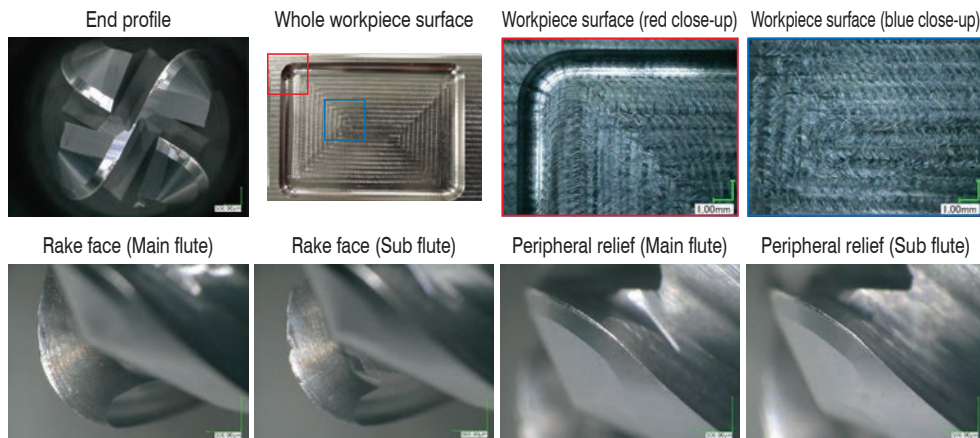

4 Flutes

$\phi 3 \text{mm}$ Shank
V Series

UDC-PCD
Series

CBN
Series

Square

Long Neck
Square

Radius

Radius
Long Neck
Radius

Taper Neck
Radius

Ball

Ball / Long
Shank Ball

Long Neck
Ball

Taper Neck
Ball

Taper

Taper

Barrel

Barrel

Spiral
V Cutter

Spiral
V Cutter

Drill

Drill

Technical Data

Technical Data



Size $\phi 1 \sim \phi 6$

DCLRS



Material Applications (★ Highly Recommended ● Recommended ○ Suggested)

Work Material																	
Carbon Steels S45C S55C	Alloy Steels SK / SCM SUS	Prehardened Steels NAK HPM	Hardened Steels					Cast Iron	Aluminum Alloys	Graphite	Copper	Plastics	Glass Filled Plastics	Titanium Alloys	Heat Resistant Alloys	Cemented Carbide	Hard Brittle (Non-Metallic) Materials
			~50HRC	~55HRC	~60HRC	~65HRC	~70HRC										
									○	★	○	○	●				○

Features

Diamond coated 4 Flute Long Neck Radius End Mills for Graphite Electrodes.
Original diamond coating offers excellent resistance to wear on Graphite milling.
Long life tool with optimized flute geometry and high adhesion diamond coating.

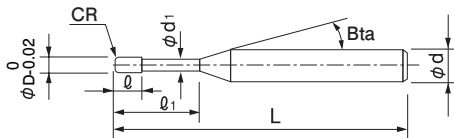

The shank taper angle shown is not an exact value and to avoid contact with the work piece, we recommend the user controls the precise value of this angle. Shank taper angle should not make contact with the work piece.

Total 39 models

Unit (mm)

Model Number	Outside Diameter ϕD	Corner Radius CR	Effective Length l_1	Length of Cut l	Neck Diameter ϕd_1	Shank Taper Angle Bta	Overall Length L	Shank Diameter ϕd	Suggested Retail Price ¥
DCLRS 4010-002-060	1	RO.02	6	2	0.97	16°	50	4	16,000
DCLRS 4010-002-100			10				50	4	16,000
DCLRS 4010-002-200			20				60	4	16,000
DCLRS 4010-005-060		RO.05	6				50	4	16,000
DCLRS 4010-005-100			10				50	4	16,000
DCLRS 4010-005-200			20				60	4	16,000
DCLRS 4015-002-120	1.5	RO.02	12	3	1.47	16°	55	4	16,000
DCLRS 4015-002-200			20				60	4	16,000
DCLRS 4015-002-300			30				80	4	17,000
DCLRS 4015-005-120		RO.05	12				55	4	16,000
DCLRS 4015-005-200			20				60	4	16,000
DCLRS 4015-005-300			30				80	4	17,000

Unit (mm)

Model Number	Outside Diameter ϕD	Corner Radius CR	Effective Length ℓ_1	Length of Cut ℓ	Neck Diameter ϕd_1	Shank Taper Angle Bta	Overall Length L	Shank Diameter ϕd	Suggested Retail Price ¥
DCLRS 4020-005-100	2	R0.05	10	4	1.98	16°	50	4	16,000
DCLRS 4020-005-200			20				60	4	16,000
DCLRS 4020-02-100			10				50	4	16,000
DCLRS 4020-02-200		R0.2	20				60	4	16,000
DCLRS 4020-02-300			30				80	4	17,000
DCLRS 4020-05-100			10				50	4	16,000
DCLRS 4020-05-200		R0.5	20				60	4	16,000
DCLRS 4020-05-300			30				80	4	17,000
DCLRS 4030-005-160			3				R0.05	16	6
DCLRS 4030-005-200	20	60		4	18,000				
DCLRS 4030-005-300	30	80		4	20,000				
DCLRS 4030-02-160	R0.2	16		60	4	18,000			
DCLRS 4030-02-200		20		60	4	18,000			
DCLRS 4030-02-300		30		80	4	20,000			
DCLRS 4030-05-160	R0.5	16		60	4	18,000			
DCLRS 4030-05-200		20		60	4	18,000			
DCLRS 4030-05-300		30		80	4	20,000			
DCLRS 4040-02-200	4	R0.2	20	8	3.93	16°	60	6	20,000
DCLRS 4040-02-300			30				80	6	20,000
DCLRS 4040-02-400			40				80	6	20,000
DCLRS 4040-05-200		R0.5	20				60	6	20,000
DCLRS 4040-05-300			30				80	6	20,000
DCLRS 4040-05-400			40				80	6	20,000
DCLRS 4060-02-300	6	R0.2	30	12	5.93	—	100	6	23,000
DCLRS 4060-02-600			60				120	6	30,000
DCLRS 4060-05-300		R0.5	30				100	6	23,000
DCLRS 4060-05-600			60				120	6	30,000

4 Flutes

ø3mm Shank
V SeriesUDC-PCD
SeriesCBN
Series

Square

Square
Long Neck
Square

Radius

Radius
Long Neck
RadiusTaper Neck
Radius

Ball

Ball / Long
Shank BallLong Neck
BallTaper Neck
Ball

Taper

Taper

Barrel

Spiral
V Cutter

Drill

Technical Data

397

Milling Conditions for DCLRS

WORK MATERIAL				GRAPHITE				
Model Number	Outside Diameter (mm)	Corner Radius (mm)	Effective Length (mm)	Spindle Speed (min ⁻¹)	Feed Rate (mm/min)	a_p Axial Depth (mm)	a_e Radial Depth (mm)	
4010-002-060	1	R0.02	6	26,000	1,700	0.12	0.7	
4010-002-100			10	22,000	1,300	0.12	0.6	
4010-002-200			20	13,000	750	0.1	0.5	
4010-005-060		R0.05	6	26,000	1,700	0.12	0.6	
4010-005-100			10	22,000	1,300	0.12	0.5	
4010-005-200			20	13,000	750	0.1	0.4	
4015-002-120	1.5	R0.02	12	19,000	1,700	0.18	1.1	
4015-002-200			20	15,000	1,300	0.14	0.9	
4015-002-300			30	10,000	800	0.11	0.7	
4015-005-120		R0.05	12	19,000	1,700	0.18	0.95	
4015-005-200			20	15,000	1,300	0.14	0.75	
4015-005-300			30	10,000	800	0.11	0.6	
4020-005-100	2	R0.05	10	20,000	2,400	0.3	1.4	
4020-005-200			20	16,000	1,800	0.25	1.35	
4020-02-100		R0.2	10	20,000	2,400	0.3	1.2	
4020-02-200			20	16,000	1,800	0.25	1.15	
4020-02-300			30	12,000	1,300	0.2	1.1	
4020-05-100			R0.5	10	20,000	2,400	0.3	0.95
4020-05-200	20	16,000		1,800	0.25	0.9		
4020-05-300	30	12,000		1,300	0.2	0.85		
4030-005-160	3	R0.05	16	16,500	3,100	0.4	2.3	
4030-005-200			20	16,000	2,900	0.4	2.1	
4030-005-300			30	14,000	2,300	0.4	1.9	
4030-02-160		R0.2	16	16,500	3,100	0.4	2	
4030-02-200			20	16,000	2,900	0.4	1.8	
4030-02-300			30	14,000	2,300	0.4	1.6	
4030-05-160	4	R0.5	16	16,500	3,100	0.4	1.7	
4030-05-200			20	16,000	2,900	0.4	1.5	
4030-05-300			30	14,000	2,300	0.4	1.4	
4040-02-200		4	R0.2	20	14,000	3,400	0.5	2.7
4040-02-300				30	13,000	3,000	0.5	2.6
4040-02-400				40	12,000	2,600	0.5	2.5
4040-05-200	R0.5		20	14,000	3,400	0.5	2.3	
4040-05-300			30	13,000	3,000	0.5	2.2	
4040-05-400			40	12,000	2,600	0.5	2.1	
4060-02-300	6	R0.2	30	13,000	4,300	0.75	4	
4060-02-600			60	10,000	2,800	0.75	3.7	
4060-05-300		R0.5	30	13,000	4,300	0.75	3.5	
4060-05-600			60	10,000	2,800	0.75	3.1	

Note:



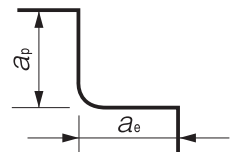

- Use a milling machine dedicated for Graphite.
- Recommend air blow for Graphite.



Other series for Graphite milling

Square / Long Neck Square





(★ Highly Recommended ● Recommended ○ Suggested)

Number of Flutes, Tool Type	Model Number	Appearance	Coating	Size	Aluminum Alloys	Graphite	Copper	Plastics	Glass Filled Plastics	Hard Brittle (Non-Metallic) Materials	Page
4 flutes Square	CGE		Non-coat	$\phi 2 \sim \phi 20$	○	★	○	○	○		236
2 flutes Square	DCES 2000		DIA	$\phi 0.2 \sim \phi 6$	○	★	○	○	●	○	188
4 flutes Square	DCES 4000		DIA	$\phi 3 \sim \phi 10$	○	★	○	○	●	○	234
2 flutes Long Neck Square	DCLS		DIA	$\phi 0.4 \sim \phi 6$	○	★	○	○	●	○	266

Long Neck Radius

4 flutes Long Neck Radius	DCLRS		DIA	$\phi 1 \sim \phi 6$	○	★	○	○	●	○	396
---------------------------	-------	---	-----	----------------------	---	---	---	---	---	---	-----

Ball / Long Neck Ball / Taper Neck Ball

2 flutes Ball	CGB 2000		Non-coat	R0.2~R6	○	★	○	○	○		440
4 flutes Ball	CGB 4000		Non-coat	R2~R10	○	★	○	○	○		458
2 flutes Ball	DCB		DIA	R0.5~R6	○	★	○	○	●	○	438
2 flutes Long Neck Ball	DCLB		DIA	R0.2~R3	○	★	○	○	●	○	512
2 flutes Taper Neck Ball	DCTNB		DIA	R0.5~R1	○	★	○	○	●	○	556

4 Flutes

φ3mm Shank
V Series

UDC-PCD
Series

CBN
Series

Square

Square
Long Neck
Square

Radius

Radius
Long Neck
Radius
Taper Neck
Radius

Ball

Ball / Long
Shank Ball
Long Neck
Ball
Taper Neck
Ball

Taper

Barrel

Spiral
V Cutter

Drill

Technical Data



Size $\phi 3 \sim \phi 12$

CXLRS



$\phi 3 \sim \phi 6$

$\phi 8 \sim \phi 12$

Material Applications (★ Highly Recommended ● Recommended ○ Suggested)

Work Material																	
Carbon Steels S45C S55C	Alloy Steels SK / SCM SUS	Prehardened Steels NAK HPM	Hardened Steels					Cast Iron	Aluminum Alloys	Graphite	Copper	Plastics	Glass Filled Plastics	Titanium Alloys	Heat Resistant Alloys	Cemented Carbide	Hard Brittle (Non-Metallic) Materials
			~50HRC	~55HRC	~60HRC	~65HRC	~70HRC										
●	●	●	●	●				○	○		●			○	○		

Features

Broad application range from Carbon Steels to Hardened Steels (55HRC).

Variable pitch, variable helix and positive rake angle design offers highly efficient side milling. Seamless Corner Radius design reduces cutting resistance.

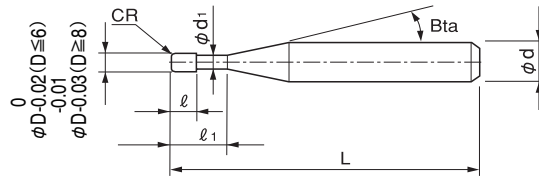

The shank taper angle shown is not an exact value and to avoid contact with the work piece, we recommend the user controls the precise value of this angle. Shank taper angle should not make contact with the work piece.

Variable Pitch

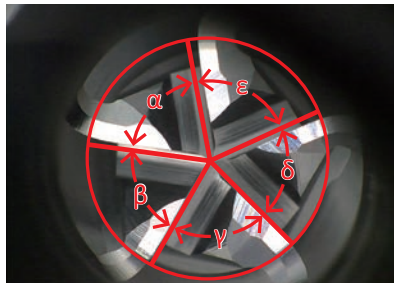

$$\alpha \neq \beta \neq \gamma \neq \delta \neq \epsilon$$

Seamless Corner Radius



Variable Helix

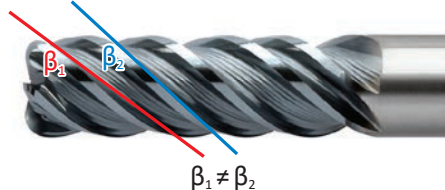

$$\beta_1 \neq \beta_2$$

φ3mm Shank V Series

UDC-PCD Series

CBN Series

Square
Long Neck Square

Radius
Long Neck Radius
Taper Neck Radius

Ball / Long Shank Ball
Long Neck Ball
Taper Neck Ball

Taper

Barrel

Spiral V Cutter

Drill

Technical Data

Total 30 models

Unit (mm)

Model Number	Outside Diameter ϕD	Corner Radius CR	Effective Length ℓ_1	Length of Cut ℓ	Neck Diameter ϕd_1	Shank Taper Angle Bta	Overall Length L	Shank Diameter ϕd	Suggested Retail Price ¥
CXLR5 5030-05-09	3	R0.5	9	6	2.95	16°	50	6	10,800
CXLR5 5030-05-12			12				50		
CXLR5 5040-05-12	4	R0.5	12	8	3.85	16°	60	6	11,600
CXLR5 5040-05-16			16				60		
CXLR5 5040-10-12		R1	12				60		
CXLR5 5040-10-16			16				60		
CXLR5 5060-05-18	6	R0.5	18	12	5.85	—	70	6	13,400
CXLR5 5060-05-24			24				70		
CXLR5 5060-10-18		R1	18				70		
CXLR5 5060-10-24			24				70		
CXLR5 5080-05-24	8	R0.5	24	16	7.8	—	70	8	16,700
CXLR5 5080-05-32			32				70		
CXLR5 5080-10-24		R1	24				70		
CXLR5 5080-10-32			32				70		
CXLR5 5100-05-30	10	R0.5	30	20	9.8	—	80	10	22,000
CXLR5 5100-05-40			40				80		
CXLR5 5100-10-30		R1	30				80		
CXLR5 5100-10-40			40				80		
CXLR5 5100-15-30		R1.5	30				80		
CXLR5 5100-15-40			40				80		
CXLR5 5100-20-30		R2	30				80		
CXLR5 5100-20-40			40				80		
CXLR5 5120-05-36	12	R0.5	36	24	11.8	—	80	12	27,700
CXLR5 5120-05-48			48				100		
CXLR5 5120-10-36		R1	36				80		
CXLR5 5120-10-48			48				100		
CXLR5 5120-15-36		R1.5	36				80		
CXLR5 5120-15-48			48				100		
CXLR5 5120-20-36		R2	36				80		
CXLR5 5120-20-48			48				100		

5 Flutes

3mm Shank V Series

UDC-PCD Series

CBN Series

Square
Long Neck Square

Radius
Long Neck Radius

Taper Neck Radius

Ball / Long Shank Ball

Ball
Long Neck Ball
Taper Neck Ball

Taper
Taper

Barrel

Spiral V Cutter

Drill

Technical Data

Milling Conditions for CXLRS

WORK MATERIAL			CARBON STEELS S45C / S50C Annealed Materials (~225HB)				ALLOY STEELS SK / SCM Annealed Materials (225~325HB)				PREHARDENED STEELS HPM / NAK (30~45HRC)				HARDENED STEELS SKD / SKT / STAVAX (45~55HRC)			
Model Number	Outside Diameter (mm)	Effective Length (mm)	Spindle Speed (min ⁻¹)	Feed Rate (mm/min)	a _p Axial Depth (mm)	a _e Radial Depth (mm)	Spindle Speed (min ⁻¹)	Feed Rate (mm/min)	a _p Axial Depth (mm)	a _e Radial Depth (mm)	Spindle Speed (min ⁻¹)	Feed Rate (mm/min)	a _p Axial Depth (mm)	a _e Radial Depth (mm)	Spindle Speed (min ⁻¹)	Feed Rate (mm/min)	a _p Axial Depth (mm)	a _e Radial Depth (mm)
5030	3	9	20,000	6,000	6	0.24	20,000	6,000	6	0.24	20,000	6,400	6	0.09	20,000	12,000	6	0.05
		12	20,000	6,000	6	0.19	20,000	6,000	6	0.19	20,000	6,400	6	0.07	20,000	12,000	6	0.04
5040	4	12	18,200	5,460	8	0.32	18,200	5,460	8	0.32	15,900	4,770	8	0.12	15,000	11,500	8	0.05
		16	18,200	5,460	8	0.26	18,200	5,460	8	0.26	15,900	4,770	8	0.1	15,000	11,500	8	0.04
5060	6	18	12,200	5,100	12	0.48	12,200	5,100	12	0.48	12,000	5,000	12	0.18	10,000	7,600	12	0.1
		24	12,200	5,100	12	0.38	12,200	5,100	12	0.38	12,000	5,000	12	0.14	10,000	7,600	12	0.08
5080	8	24	9,100	4,550	16	0.64	9,100	4,550	16	0.64	9,000	4,500	16	0.32	7,600	5,600	16	0.15
		32	9,100	4,550	16	0.51	9,100	4,550	16	0.51	9,000	4,500	16	0.26	7,600	5,600	16	0.12
5100	10	30	7,300	3,650	20	0.8	7,300	3,650	20	0.8	7,300	3,650	20	0.4	6,000	4,500	20	0.22
		40	7,300	3,650	20	0.64	7,300	3,650	20	0.64	7,300	3,650	20	0.32	6,000	4,500	20	0.176
5120	12	36	6,100	3,050	24	0.96	6,100	3,050	24	0.96	6,100	3,050	24	0.48	5,000	3,800	24	0.25
		48	6,100	3,050	24	0.77	6,100	3,050	24	0.77	6,100	3,050	24	0.38	5,000	3,800	24	0.2

Note:

- Please be sure to use water soluble coolant.
- These milling parameters are for reference only. For best result, fine parameter adjustments may be required, depending on the milling shape / application / machine and so on.
- Decrease both spindle speed and feed rate proportionally when the milling parameters exceed the machine's maximum spindle speed.
- WARNING: Because of high material removal rate, you must pay attention to your chip and coolant management.

Side Milling

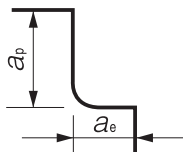

- 3mm Shank V Series
- UDC-PCD Series
- CBN Series
- Square
- Long Neck Square
- Radius
- Long Neck Radius
- Taper Neck Radius
- Ball / Long Shank Ball
- Long Neck Ball
- Taper Neck Ball
- Taper
- Barrel
- Spiral V Cutter
- Drill
- Technical Data

Roughing Example : CXLRS $\phi 6 \times CR0.5 \times EL24$

RAMAX (32HRC)



Size : 500 x 500 mm
Coolant : Air Blow
Milling Method : Vortex (Trochoid)

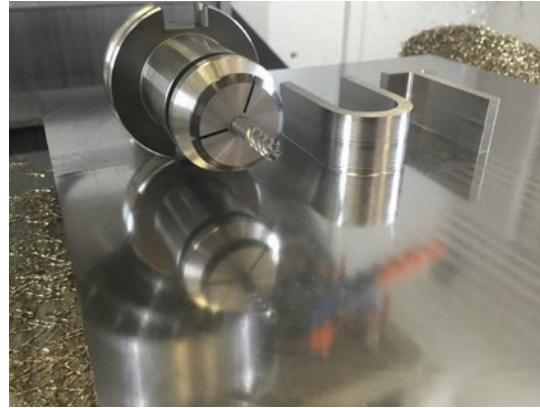

Spindle Speed : 14,000 min⁻¹
Feed Rate : 7,000 mm/min
 a_p : 12 mm
 a_e : 0.5 mm

CXLRS
Roughing Video



5 Flutes

$\phi 3$ mm Shank
V Series

UDC-PCD
Series

CBN
Series

Square

Square

Long Neck
Square

Radius

Radius

Long Neck
Radius

Taper Neck
Radius

Ball

Ball / Long
Shank Ball

Long Neck
Ball

Taper Neck
Ball

Taper

Taper

Barrel

Barrel

Spiral
V Cutter

Spiral
V Cutter

Drill

Drill

Technical Data

Technical Data



Size $\phi 3 \sim \phi 12$

HHRS



Additional 9 models

Material Applications (★ Highly Recommended ● Recommended ○ Suggested)

Work Material																	
Carbon Steels S45C S55C	Alloy Steels SK / SCM SUS	Prehardened Steels NAK HPM	Hardened Steels					Cast Iron	Aluminum Alloys	Graphite	Copper	Plastics	Glass Filled Plastics	Titanium Alloys	Heat Resistant Alloys	Cemented Carbide	Hard Brittle (Non-Metallic) Materials
			~50HRC	~55HRC	~60HRC	~65HRC	~70HRC										
○	○	●	●	●	○		○			○				○	○		

Features

Long Neck Radius design for milling on Hard Materials.
The cutting edge is designed for offering high rigidity.

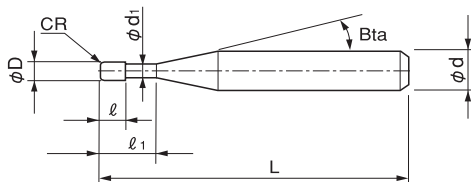

The shank taper angle shown is not an exact value and to avoid contact with the work piece, we recommend the user controls the precise value of this angle. Shank taper angle should not make contact with the work piece.

Total 23 models

Unit (mm)

Model Number	Outside Diameter ϕD	Corner Radius CR	Effective Length ℓ_1	Length of Cut ℓ	Neck Diameter ϕd_1	Shank Taper Angle Bta	Overall Length L	Shank Diameter ϕd	Number of Flutes	Suggested Retail Price ¥
※ HHRS 4030-01-100	3	RO.1	10	3	2.95	11°	60	6	4	7,100
※ HHRS 4030-02-100		RO.2								7,100
※ HHRS 4030-05-100		RO.5								7,100
※ HHRS 4040-01-120	4	RO.1	12	4	3.95	11°	60	6	4	10,600
※ HHRS 4040-02-120		RO.2								10,600
※ HHRS 4040-05-120		RO.5								10,600
※ HHRS 4040-10-120		R1								10,600
※ HHRS 4050-02-160	5	RO.2	16	5	4.95	11°	60	6	4	14,000
※ HHRS 4050-05-160		RO.5								14,000
HHRS 6060-01-210	6	RO.1	21	6	5.95	—	60	6	6	16,800
HHRS 6060-02-210		RO.2								16,800
HHRS 6060-03-210		RO.3								16,800
HHRS 6060-05-210		RO.5								16,800
HHRS 6060-10-210		R1								16,800

※Additional model

Unit (mm)

Model Number	Outside Diameter ϕD	Corner Radius CR	Effective Length ℓ_1	Length of Cut ℓ	Neck Diameter ϕd_1	Shank Taper Angle Bta	Overall Length L	Shank Diameter ϕd	Number of Flutes	Suggested Retail Price ¥
HHRS 6080-03-260	8	RO.3	26	8	7.81	—	80	8	6	21,780
HHRS 6080-05-260		RO.5					80	8		21,780
HHRS 6080-10-260		R1					80	8		21,780
HHRS 6100-03-310	10	RO.3	31	10	9.81	—	80	10	6	22,990
HHRS 6100-05-310		RO.5					80	10		22,990
HHRS 6100-10-310		R1					80	10		22,990
HHRS 6120-03-370	12	RO.3	37	12	11.81	—	100	12	6	32,670
HHRS 6120-05-370		RO.5					100	12		32,670
HHRS 6120-10-370		R1					100	12		32,670

Bottom Surface Milling Comparison between HHRS & 4 Flute Square End Mills NAK80 (40HRC)

Spindle Speed	Feed Rate	a_p	a_e	Overhang Length	Coolant
6,300 min ⁻¹	2,650 mm/min	0.12 mm	1.2 mm	22 mm	Air blow (Nozzle)

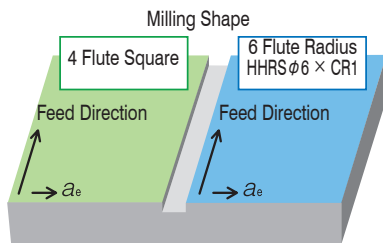

Better bottom surface roughness compared to 4 flute square type.

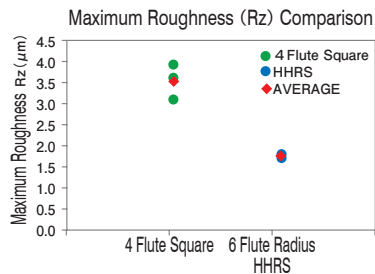
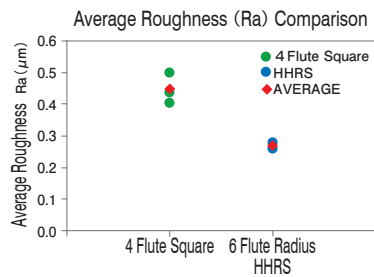

4 Flutes

6 Flutes

$\phi 3$ mm Shank V Series

UDC-PCD Series

CBN Series

Square

Long Neck Square

Radius

Long Neck Radius

Taper Neck Radius

Ball / Long Shank Ball

Long Neck Ball

Taper Neck Ball

Taper

Barrel

Spiral V Cutter

Drill

Technical Data

Milling Conditions for HHRs

Side Milling

WORK MATERIAL		CARBON STEELS S45C / S50C				ALLOY STEELS SK / SCM / SUS				PREHARDENED STEELS HARDENED STEELS (30~45HRC)			
Model Number	Outside Diameter (mm)	Spindle Speed (min ⁻¹)	Feed Rate (mm/min)	a_p (mm)	a_e (mm)	Spindle Speed (min ⁻¹)	Feed Rate (mm/min)	a_p (mm)	a_e (mm)	Spindle Speed (min ⁻¹)	Feed Rate (mm/min)	a_p (mm)	a_e (mm)
4030	3	12,600	1,750	3	0.12	12,600	1,750	3	0.12	12,600	1,750	3	0.12
4040	4	9,500	1,750	4	0.16	9,500	1,750	4	0.16	9,500	1,750	4	0.16
4050	5	7,600	1,750	5	0.2	7,600	1,750	5	0.2	7,600	1,750	5	0.2
6060	6	6,300	2,650	6	0.24	6,300	2,650	6	0.24	6,300	2,650	6	0.24
6080	8	4,750	2,650	8	0.32	4,750	2,650	8	0.32	4,750	2,650	8	0.32
6100	10	3,800	2,650	10	0.4	3,800	2,650	10	0.4	3,800	2,650	10	0.4
6120	12	3,150	2,650	12	0.48	3,150	2,650	12	0.48	3,150	2,650	12	0.48
Milling Amount (mm)		$a_p: 1D$ $a_e: 0.04D$				$a_p: 1D$ $a_e: 0.04D$				$a_p: 1D$ $a_e: 0.04D$			

Bottom Surface Milling

WORK MATERIAL		CARBON STEELS S45C / S50C				ALLOY STEELS SK / SCM / SUS				PREHARDENED STEELS HARDENED STEELS (30~45HRC)			
Model Number	Outside Diameter (mm)	Spindle Speed (min ⁻¹)	Feed Rate (mm/min)	a_p (mm)	a_e (mm)	Spindle Speed (min ⁻¹)	Feed Rate (mm/min)	a_p (mm)	a_e (mm)	Spindle Speed (min ⁻¹)	Feed Rate (mm/min)	a_p (mm)	a_e (mm)
4030	3	12,600	1,750	0.06	0.6	12,600	1,750	0.06	0.6	12,600	1,750	0.06	0.6
4040	4	9,500	1,750	0.08	0.8	9,500	1,750	0.08	0.8	9,500	1,750	0.08	0.8
4050	5	7,600	1,750	0.1	1	7,600	1,750	0.1	1	7,600	1,750	0.1	1
6060	6	6,300	2,650	0.12	1.2	6,300	2,650	0.12	1.2	6,300	2,650	0.12	1.2
6080	8	4,750	2,650	0.16	1.6	4,750	2,650	0.16	1.6	4,750	2,650	0.16	1.6
6100	10	3,800	2,650	0.2	2	3,800	2,650	0.2	2	3,800	2,650	0.2	2
6120	12	3,150	2,650	0.24	2.4	3,150	2,650	0.24	2.4	3,150	2,650	0.24	2.4
Milling Amount (mm)		$a_p: 0.02D$ $a_e: 0.2D$				$a_p: 0.02D$ $a_e: 0.2D$				$a_p: 0.02D$ $a_e: 0.2D$			

Note:

- Decrease both spindle speed and feed rate proportionally when the milling parameters exceed the machines maximum speed, or when the tool is chattering and heats up to a red color.
- When milling on a side or bottom surface, set the ap amount taking into consideration the remaining corner area.
- Recommend wet coolant for Stainless Steels.

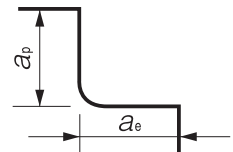

D : Outside Diameter (mm)

Milling Conditions for HHRS

WORK MATERIAL		HARDENED STEELS (45~55HRC)				HARDENED STEELS (55~65HRC)			
Model Number	Outside Diameter (mm)	Spindle Speed (min ⁻¹)	Feed Rate (mm/min)	a_p (mm)	a_e (mm)	Spindle Speed (min ⁻¹)	Feed Rate (mm/min)	a_p (mm)	a_e (mm)
4030	3	9,600	1,300	2.4	0.06	6,400	1,000	1.5	0.015**
4040	4	7,200	1,300	3.2	0.08	4,800	1,000	2	0.02**
4050	5	5,700	1,300	4	0.1	4,000	1,000	2.5	0.025**
6060	6	4,800	2,000	4.8	0.12	3,200	1,600	3	0.06
6080	8	3,600	2,000	6.4	0.16	2,400	1,600	4	0.08
6100	10	2,850	2,000	8	0.2	2,000	1,600	5	0.1
6120	12	2,400	2,000	9.6	0.24	1,600	1,600	6	0.12
Milling Amount (mm)		a_p :0.8D a_e :0.02D				a_p :0.5D a_e :0.01D ** a_e :0.005D			

WORK MATERIAL		HARDENED STEELS (45~55HRC)				HARDENED STEELS (55~65HRC)			
Model Number	Outside Diameter (mm)	Spindle Speed (min ⁻¹)	Feed Rate (mm/min)	a_p (mm)	a_e (mm)	Spindle Speed (min ⁻¹)	Feed Rate (mm/min)	a_p (mm)	a_e (mm)
4030	3	9,600	1,300	0.045	0.6	6,400	1,000	0.03	0.6
4040	4	7,200	1,300	0.06	0.8	4,800	1,000	0.04	0.8
4050	5	5,700	1,300	0.075	1	4,000	1,000	0.05	1
6060	6	4,800	2,000	0.09	1.2	3,200	1,600	0.06	1.2
6080	8	3,600	2,000	0.12	1.6	2,400	1,600	0.08	1.6
6100	10	2,850	2,000	0.15	2	2,000	1,600	0.1	2
6120	12	2,400	2,000	0.18	2.4	1,600	1,600	0.12	2.4
Milling Amount (mm)		a_p :0.015D a_e :0.2D				a_p :0.01D a_e :0.2D			

4 Flutes

6 Flutes

ø3mm Shank
V SeriesUDC-PCD
SeriesCBN
Series

Square

Square

Long Neck
Square

Radius

Radius

Long Neck
RadiusTaper Neck
RadiusBall / Long
Shank Ball

Ball

Long Neck
BallTaper Neck
Ball

Taper

Taper

Barrel

Spiral
V Cutter

Drill

Technical Data



Size $\phi 2 \sim \phi 12$

HGRRS

NEW



$\phi 2 \sim \phi 6$ $\phi 8 \sim \phi 12$ $\phi 2 \sim \phi 6$ $\phi 8 \sim \phi 12$

Material Applications (★ Highly Recommended ● Recommended ○ Suggested)

Work Material																	
Carbon Steels S45C S55C	Alloy Steels SK / SCM SUS	Prehardened Steels NAK HPM	Hardened Steels					Cast Iron	Aluminum Alloys	Graphite	Copper	Plastics	Glass Filled Plastics	Titanium Alloys	Heat Resistant Alloys	Cemented Carbide	Hard Brittle (Non-Metallic) Materials
			~50HRC	~55HRC	~60HRC	~65HRC	~70HRC										
		○	●	●	★	●	●										

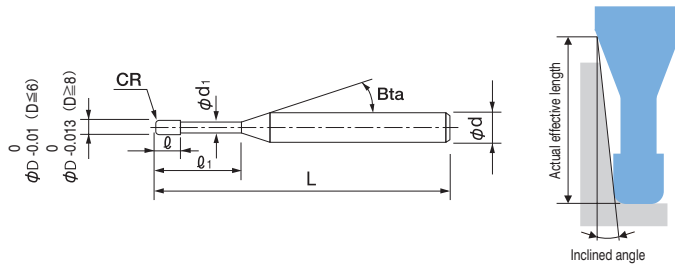

The shank taper angle shown is not an exact value and to avoid contact with the work piece, we recommend the user controls the precise value of this angle. Shank taper angle should not make contact with the work piece.

High efficiency

Multi-flutes, variable pitch and a short length of cut are some of the features that are very suitable for bottom surface milling.

5 Flutes $\phi 2 \sim \phi 4$

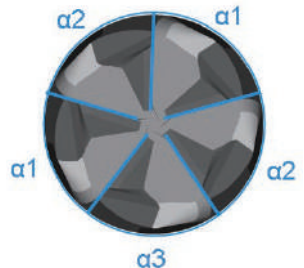

6 Flutes $\phi 6 \sim \phi 12$

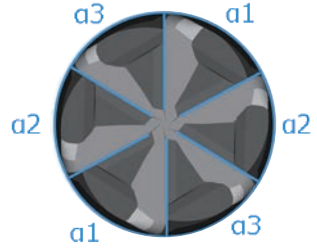

Short length of cut for high rigidity

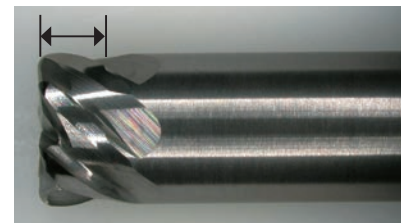

High precision

Outside Diameter	Diameter Tolerance	Radius Accuracy
$\phi 2 \sim 6$	0/-0.01	±0.003
$\phi 8 \sim 12$	0/-0.013	±0.005

- φ3mm Shank V Series
- UDC-PCD Series
- CBN Series
- Square
- Long Neck Square
- Radius
- Long Neck Radius
- Taper Neck Radius
- Ball / Long Shank Ball
- Long Neck Ball
- Taper Neck Ball
- Taper
- Barrel
- Spiral V Cutter
- Drill
- Technical Data

Total 19 models

Unit (mm)

Model Number	Outside Diameter ϕD	Corner Radius CR	Effective Length l_1	Length of Cut l	Neck Diameter ϕd_1	Shank Taper Angle Bta	Overall Length L	Shank Diameter ϕd	Number of Flutes	Suggested Retail Price ¥
HGRRS 5020-05-06	2	R0.5	6	1	1.95	16°	50	4	5	9,920
HGRRS 5030-08-09	3	R0.8	9	1.5	2.95	16°	60	4	5	10,210
HGRRS 5040-05-12	4	R0.5	12	2	3.95	—	60	4	5	9,450
HGRRS 5040-05-12-6						16°	60	6		10,960
HGRRS 5040-10-12		—				60	4	9,450		
HGRRS 5040-10-12-6		16°				60	6	10,960		
HGRRS 6060-03-18	6	R0.3	18	2.5	5.95	—	60	6	6	12,660
HGRRS 6060-05-18		R0.5					60	6		12,660
HGRRS 6060-10-18		R1					60	6		12,660
HGRRS 6060-15-18		R1.5					60	6		12,660
HGRRS 6080-05-24	8	R0.5	24	3.4	7.87	—	70	8	6	15,780
HGRRS 6080-10-24		R1					70	8		15,780
HGRRS 6080-20-24		R2					70	8		15,780
HGRRS 6100-05-30	10	R0.5	30	4.2	9.87	—	80	10	6	20,790
HGRRS 6100-10-30		R1					80	10		20,790
HGRRS 6100-20-30		R2					80	10		20,790
HGRRS 6120-05-36	12	R0.5	36	5	11.87	—	90	12	6	26,180
HGRRS 6120-10-36		R1					90	12		26,180
HGRRS 6120-20-36		R2					90	12		26,180

Flat surface milling example
HGRRS $\phi 6 \times CR0.5 \times EL18$

SKD11 (60HRC)

Stable milling and wear resistance are achievable even when using high efficiency milling conditions.

Spindle Speed	3,000 min ⁻¹
Feed Rate	6,800 mm/min
a_p	0.08 mm
a_e	4.1 mm
Work Size	100 × 200 × 2.4 mm
Cycle Time	30 min

HGRRS

Conventional

Competitor
Lasted only 10min

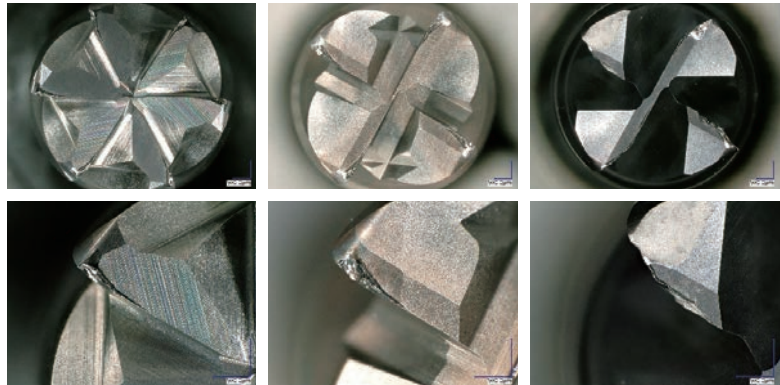

Relief wear width (mm)

HGRRS	Conventional	Competitor
0.163	0.296	Chipping



a_e 4.1mm for a tool diameter of $\phi 6$.

5 Flutes

6 Flutes

$\phi 3$ mm Shank
V Series

UDC-PCD
Series

CBN
Series

Square
Long Neck
Square

Radius

Long Neck
Radius

Taper Neck
Radius

Ball / Long
Shank Ball

Long Neck
Ball

Taper Neck
Ball

Taper

Barrel



Spiral
V Cutter

Drill

Technical Data

Thin cut wide pitch milling
 $\phi 6 \times C R 0.5$ Compared to catalogue conditions

SKD11 (60HRC)

Tool Series	Number of Flutes	Spindle Speed (min ⁻¹)	Feed Rate (mm/min)	Feed per tooth (mm/t)	a_p (mm)	a_e (mm)	Material Removal Amount (mm ³ /min)
HGRRS 	6 flutes	3,000	6,800	0.378	0.08	4.1	2,230
HRRS 	4 flutes	6,000	2,070	0.086	0.11	1.08	246

High efficiency bottom surface milling is possible due to large a_e

When feed rate cannot be increased
 $\phi 6 \times C R 0.5$

SKD11 (60HRC)

	Spindle Speed (min ⁻¹)	Feed Rate (mm/min)	Feed per tooth (mm/t)	a_p (mm)	a_e (mm)	Material Removal Amount (mm ³ /min)
HGRRS Catalogue conditions	3,000	6,800	0.378	0.08	4.1	2,230



Feed rate lowered (Catalogue condition for 4 flutes radius HRRS)	6,000	2,070	0.058	0.11	1.08	246
--	-------	--------------	-------	------	------	-----

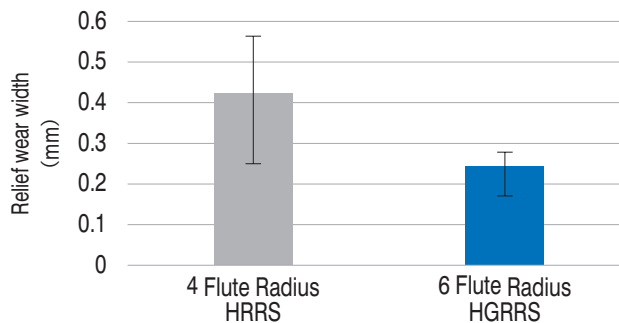

HGRRS display wear resistance even under conditions with low feed rate.

- $\phi 3$ mm Shank V Series
- UDC-PCD Series
- CBN Series
- Square
- Long Neck Square
- Radius
- Long Neck Radius
- Taper Neck Radius
- Ball / Long Shank Ball
- Long Neck Ball
- Taper Neck Ball
- Taper
- Barrel
- Spiral V Cutter
- Drill
- Technical Data

Milling Conditions for HGRRS

WORK MATERIAL			PREHARDENED STEELS / HARDENED STEELS NAK / STAVAX (~55HRC)				HARDENED STEELS SKD11 (55~62HRC)				HARDENED STEELS HAP10 (62~66HRC)				HARDENED STEELS HAP72 (66~70HRC)			
Model Number	Outside Diameter (mm)	Corner Radius (mm)	Spindle Speed (min ⁻¹)	Feed Rate (mm/min)	a_p Axial Depth (mm)	a_e Radial Depth (mm)	Spindle Speed (min ⁻¹)	Feed Rate (mm/min)	a_p Axial Depth (mm)	a_e Radial Depth (mm)	Spindle Speed (min ⁻¹)	Feed Rate (mm/min)	a_p Axial Depth (mm)	a_e Radial Depth (mm)	Spindle Speed (min ⁻¹)	Feed Rate (mm/min)	a_p Axial Depth (mm)	a_e Radial Depth (mm)
5020-05-06	2	R0.5	10,000	2,700	0.07	0.8	8,000	2,000	0.05	0.8	2,640	2,500	0.05	0.6	2,400	2,270	0.05	0.56
5030-08-09	3	R0.8	8,500	4,000	0.1	1.3	5,500	3,000	0.05	1.3	1,980	1,980	0.05	0.9	1,800	1,800	0.05	0.78
5040-05-12	4	R0.5	7,500	5,000	0.11	1.8	4,300	4,000	0.06	1.8	1,540	1,650	0.06	1.2	1,400	1,500	0.06	1.1
5040-05-12-6			7,500	5,000	0.11	1.8	4,300	4,000	0.06	1.8	1,540	1,650	0.06	1.2	1,400	1,500	0.06	1.1
5040-10-12		R1	7,500	5,000	0.11	1.8	4,300	4,000	0.06	1.8	1,540	1,650	0.06	1.2	1,400	1,500	0.06	1.1
5040-10-12-6			7,500	5,000	0.11	1.8	4,300	4,000	0.06	1.8	1,540	1,650	0.06	1.2	1,400	1,500	0.06	1.1
6060-03-18	6	R0.3	6,000	7,800	0.12	4.1	3,000	6,800	0.08	4.1	1,100	1,760	0.08	1.9	1,000	1,600	0.08	1.7
6060-05-18		R0.5	6,000	7,800	0.12	4.1	3,000	6,800	0.08	4.1	1,100	1,760	0.08	1.9	1,000	1,600	0.08	1.7
6060-10-18		R1	6,000	7,800	0.12	3.6	3,000	6,800	0.08	3.6	1,100	1,760	0.08	1.9	1,000	1,600	0.08	1.7
6060-15-18		R1.5	6,000	7,800	0.12	2.7	3,000	6,800	0.08	2.7	1,100	1,760	0.08	1.9	1,000	1,600	0.08	1.7
6080-05-24	8	R0.5	4,800	6,600	0.12	3.6	2,000	6,300	0.08	3.6	830	1,760	0.08	2.2	750	1,600	0.08	2
6080-10-24		R1	4,800	6,600	0.12	3.6	2,000	6,300	0.08	3.6	830	1,760	0.08	2.2	750	1,600	0.08	2
6080-20-24		R2	4,800	6,600	0.2	3.6	2,000	6,300	0.08	3.6	830	1,760	0.08	2.2	750	1,600	0.08	2
6100-05-30		10	R0.5	4,300	6,200	0.11	5.4	1,500	5,800	0.08	5.4	620	1,820	0.08	2.5	560	1,650	0.08
6100-10-30	R1		4,300	6,200	0.11	5.4	1,500	5,800	0.08	5.4	620	1,820	0.08	2.5	560	1,650	0.08	2.3
6100-20-30	R2		4,300	6,200	0.2	5.4	1,500	5,800	0.08	5.4	620	1,820	0.08	2.5	560	1,650	0.08	2.3
6120-05-36	12	R0.5	4,000	6,000	0.1	7.38	1,000	5,200	0.08	7.38	360	1,910	0.08	3.3	330	1,740	0.08	3
6120-10-36		R1	4,000	6,000	0.1	7.38	1,000	5,200	0.08	7.38	360	1,910	0.08	3.3	330	1,740	0.08	3
6120-20-36		R2	4,000	6,000	0.2	7.38	1,000	5,200	0.08	7.38	360	1,910	0.08	3.3	330	1,740	0.08	3

- Note:
- Decrease the feed rate more than 50% from the milling parameters when slot milling.
 - Decrease both spindle speed and feed rate proportionally when the milling parameters exceed the machine's maximum spindle speed, or when chattering and red-hot occur.
 - Every coolant offers stable milling.

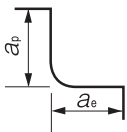

5 Flutes

6 Flutes

Ø3mm Shank V Series

UDC-PCD Series

CBN Series

Square

Long Neck Square

Radius

Long Neck Radius

Taper Neck Radius

Ball / Long Shank Ball

Long Neck Ball

Taper Neck Ball

Taper

Barrel

Spiral V Cutter

Drill

Technical Data



Size $\phi 1 \sim \phi 6$

HTNRS

Super MG
HARD MAX
45°
R
 ± 0.01
Shank Dia 0/-0.005
Back Taper Geometry
Variable Pitch

Material Applications (★ Highly Recommended ● Recommended ○ Suggested)

Work Material																	
Carbon Steels	Alloy Steels	Prehardened Steels	Hardened Steels					Cast Iron	Aluminum Alloys	Graphite	Copper	Plastics	Glass Filled Plastics	Titanium Alloys	Heat Resistant Alloys	Cemented Carbide	Hard Brittle (Non-Metallic) Materials
S45C	SK / SCM	NAK	~50HRC	~55HRC	~60HRC	~65HRC	~70HRC										
S55C	SUS	HPM															
		●	●	●	●	○		○									

The shank taper angle shown is not an exact value and to avoid contact with the work piece, we recommend the user controls the precise value of this angle. Shank taper angle should not make contact with the work piece.

Shape A

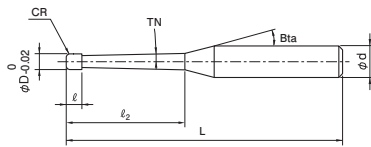

Shape B

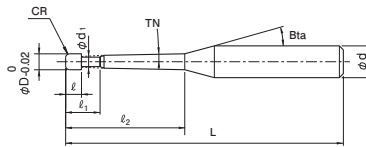

Shape C

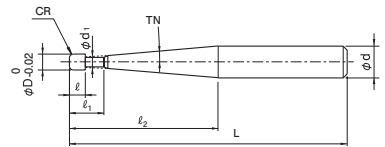

Total 111 models

Unit (mm)

Model Number	Outside Diameter ϕD	Corner Radius CR	Neck Taper Angle TN	Neck Length l_2	Effective Length l_1	Length of Cut l	Neck Diameter ϕd_1	Shank Taper Angle Bta	Overall Length L	Shank Diameter ϕd
HTNRS 4010-020608	1	R0.2	0.4°	6	—	1	—	16°	50	4
HTNRS 4010-021008				10					50	4
HTNRS 4010-022008				20					60	4
HTNRS 4010-023008				30					70	4
HTNRS 4010-020618				6					50	4
HTNRS 4010-021018				10					50	4
HTNRS 4010-021518			15	50	4					
HTNRS 4010-022018			20	60	4					
HTNRS 4010-022518			25	60	4					
HTNRS 4010-023018			30	70	4					
HTNRS 4010-023518			35	80	4					
HTNRS 4010-024018			40	80	4					
HTNRS 4010-025018			50	90	4					
HTNRS 4010-020628			6	50	4					
HTNRS 4010-021028			10	50	4					
HTNRS 4010-022028			20	60	4					
HTNRS 4010-023028	30	70	4							

Features

4 Flute Taper Neck Radius End Mills for milling hard materials. Corner radius design from the edge to the periphery ensures less cutting resistance, and the variable pitch design minimizes chattering and vibration. Can achieve stable milling and excellent surface finish on deep milling. HARDMAX coating offers longer tool life when milling hard materials. Recommended to use with any type of coolant.

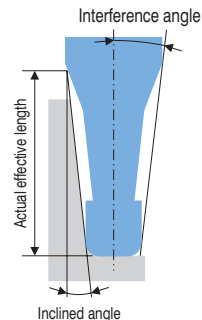

Feature ①

Seamless Corner Radius
High rigidity! Less cutting resistance!

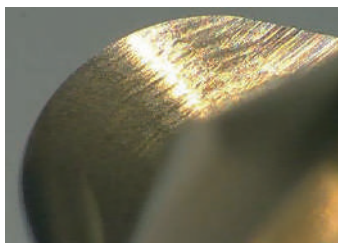

Feature ②

Variable Pitch design
Minimizing vibration and chattering !

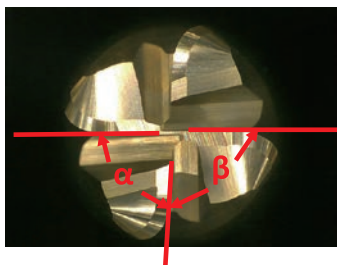

※ Variable Pitch : $\alpha \neq \beta$

Feature ③

A wide choice of Taper Neck Angles available
More efficient with 1.4° · 1.9° · 2.9° !



Unit (mm)

Model Number	Outside Diameter ϕD	Corner Radius CR	Neck Taper Angle TN	Neck Length ϕ_2	Shape	Suggested Retail Price ¥	Interference Angle	Effective Length by Inclined Angles — : Interference					
								30'	1°	1°30'	2°	3°	
HTNRS 4010-020608	1	R0.2	0.4°	6	A	10,000	7.37°	6.56	6.92	7.20	7.45	8.00	
HTNRS 4010-021008				10		10,000	5.54°	10.61	11.12	11.50	11.89	12.77	
HTNRS 4010-022008				20		10,000	3.42°	20.73	21.52	22.24	23.00	24.71	
HTNRS 4010-023008				30		12,000	2.47°	30.83	31.91	32.97	34.11	No Interference	
HTNRS 4010-020618				6		10,000	7.49°	—	6.61	6.96	7.23	7.76	
HTNRS 4010-021018				10		10,000	5.65°	—	10.66	11.15	11.53	12.38	
HTNRS 4010-021518			15	10,000		4.33°	—	15.72	16.35	16.92	18.17		
HTNRS 4010-022018			20	10,000		3.50°	—	20.77	21.56	22.30	23.95		
HTNRS 4010-022518			25	10,000		2.94°	—	25.82	26.76	27.68	No Interference		
HTNRS 4010-023018			30	12,000		2.54°	—	30.87	31.96	33.06	No Interference		
HTNRS 4010-023518			35	14,000		2.23°	—	35.92	37.16	38.44	No Interference		
HTNRS 4010-024018			40	14,000		1.99°	—	40.96	42.36	No Interference	No Interference		
HTNRS 4010-025018			50	15,000		1.64°	—	51.02	52.74	No Interference	No Interference		
HTNRS 4010-020628			6	1.4°		B	10,000	7.61°	—	—	6.66	7.00	7.53
HTNRS 4010-021028			10				10,000	5.77°	—	—	10.71	11.18	12.00
HTNRS 4010-022028			20				10,000	3.59°	—	—	20.81	21.59	23.20
HTNRS 4010-023028			30				12,000	2.61°	—	—	30.91	32.01	No Interference

Next Page ➡

4 Flutes

$\phi 3$ mm Shank
V Series

UDC-PCD
Series

CBN
Series

Square
Square
Long Neck
Square

Radius
Radius
Long Neck
Radius

Taper Neck
Radius

Ball / Long
Shank Ball

Ball
Long Neck
Ball
Taper Neck
Ball

Taper
Taper

Barrel

Spiral
V Cutter

Drill

Technical Data

413

Unit (mm)

Model Number	Outside Diameter ϕD	Corner Radius CR	Neck Taper Angle TN	Neck Length ℓ_2	Effective Length ℓ_1	Length of Cut ℓ	Neck Diameter ϕd_1	Shank Taper Angle Bta	Overall Length L	Shank Diameter ϕd				
HTNRS 40125-020618	1.25	R0.2	0.9°	6	—	1.25	—	16°	50	4				
HTNRS 40125-021018				10					50	4				
HTNRS 40125-021518				15					50	4				
HTNRS 40125-022018				20					60	4				
HTNRS 40125-023018				30					70	4				
HTNRS 40125-024018				40					80	4				
HTNRS 40125-025018				50					90	4				
HTNRS 4015-030608	1.5	R0.3	0.4°	6	—	1.5	—	16°	50	4				
HTNRS 4015-031008				10					50	4				
HTNRS 4015-032008				20					60	4				
HTNRS 4015-033008				30					70	4				
HTNRS 4015-030618			0.9°	6					—	1.5	—	16°	50	4
HTNRS 4015-031018				10									50	4
HTNRS 4015-031518				15									50	4
HTNRS 4015-032018				20									60	4
HTNRS 4015-032518				25									60	4
HTNRS 4015-033018				30									70	4
HTNRS 4015-034018			40	80					4					
HTNRS 4015-035018			50	90					4					
HTNRS 4015-030628			1.4°	6					2.7	1.43	1.43	16°	50	4
HTNRS 4015-031028				10									50	4
HTNRS 4015-032028	20	60		4										
HTNRS 4015-033028	30	70		4										
HTNRS 40175-030618	1.75	R0.3	0.9°	6	—	1.75	—	16°	50	4				
HTNRS 40175-031018				10					50	4				
HTNRS 40175-031518				15					60	4				
HTNRS 40175-032018				20					60	4				
HTNRS 40175-033018				30					70	4				
HTNRS 40175-034018				40					80	4				
HTNRS 40175-035018				50					90	4				
HTNRS 4020-052008	2	R0.5	0.4°	20	—	2	—	16°	60	4				
HTNRS 4020-052608				26					60	4				
HTNRS 4020-053008				30					70	4				
HTNRS 4020-053608				36					80	4				
HTNRS 4020-054008				40					80	4				
HTNRS 4020-051018				10					60	4				
HTNRS 4020-051518			15	60					4					
HTNRS 4020-052018			20	60					4					
HTNRS 4020-052518			25	60					4					
HTNRS 4020-053018			30	70					4					
HTNRS 4020-053518			35	80					4					
HTNRS 4020-054018			40	80					4					
HTNRS 4020-054518			45	90					4					
HTNRS 4020-055018			50	90					4					
HTNRS 4020-053028			0.9°	30					3.6	1.9	1.9	16°	70	4
HTNRS 4020-054028				40									80	4
HTNRS 4020-053038				30									70	6
HTNRS 4020-054038				40									80	6
HTNRS 4020-053058			2.9°	30					—	—	—	16°	70	6
HTNRS 4020-054258				42									90	6

- $\phi 3\text{mm}$ Shank V Series
- UDC-PCD Series
- CBN Series
- Square
- Long Neck Square
- Radius
- Long Neck Radius
- Taper Neck Radius
- Ball / Long Shank Ball
- Long Neck Ball
- Taper Neck Ball
- Taper
- Barrel
- Spiral V Cutter
- Drill
- Technical Data

Unit (mm)

Model Number	Outside Diameter ϕD	Corner Radius CR	Neck Taper Angle TN	Neck Length ℓ_2	Shape	Suggested Retail Price ¥	Interference Angle	Effective Length by Inclined Angles — : Interference				
								30'	1°	1°30'	2°	3°
HTNRS 40125-020618	1.25	R0.2	0.9°	6	A	10,000	7.14°	—	6.63	6.97	7.24	7.77
HTNRS 40125-021018				10		10,000	5.34°	—	10.68	11.16	11.55	12.40
HTNRS 40125-021518				15		10,000	4.05°	—	15.74	16.37	16.93	18.18
HTNRS 40125-022018				20		10,000	3.27°	—	20.79	21.57	22.31	23.96
HTNRS 40125-023018				30		12,000	2.36°	—	30.89	31.97	33.07	No Interference
HTNRS 40125-024018				40		14,000	1.84°	—	40.97	42.37	No Interference	No Interference
HTNRS 40125-025018				50		15,000	1.51°	—	51.03	52.75	No Interference	No Interference
HTNRS 4015-030608	1.5	R0.3	0.4°	6	A	10,000	6.69°	6.62	6.96	7.23	7.47	8.01
HTNRS 4015-031008				10		10,000	4.92°	10.66	11.15	11.52	11.91	12.79
HTNRS 4015-032008				20		10,000	2.96°	20.78	21.55	22.26	23.03	No Interference
HTNRS 4015-033008				30		12,000	2.12°	30.87	31.94	33.00	34.13	No Interference
HTNRS 4015-030618			0.9°	6		10,000	6.80°	—	6.69	7.01	7.27	7.79
HTNRS 4015-031018				10		10,000	5.03°	—	10.73	11.19	11.57	12.42
HTNRS 4015-031518				15		10,000	3.79°	—	15.79	16.39	16.95	18.20
HTNRS 4015-032018			20	10,000		3.04°	—	20.84	21.60	22.34	23.99	
HTNRS 4015-032518			25	10,000		2.54°	—	25.88	26.80	27.72	No Interference	
HTNRS 4015-033018			30	12,000		2.18°	—	30.93	32.00	33.10	No Interference	
HTNRS 4015-034018			40	14,000		1.70°	—	41.01	42.40	No Interference	No Interference	
HTNRS 4015-035018			50	15,000		1.39°	—	51.07	No Interference	No Interference	No Interference	
HTNRS 4015-030628			1.4°	6		10,000	6.92°	—	—	6.76	7.06	7.58
HTNRS 4015-031028				10		10,000	5.13°	—	—	10.80	11.23	12.05
HTNRS 4015-032028				20		10,000	3.12°	—	—	20.89	21.65	23.25
HTNRS 4015-033028	30	12,000		2.24°	—	—	30.98	32.07	No Interference			
HTNRS 40175-030618	1.75	R0.3	0.9°	6	A	10,000	6.37°	—	6.75	7.06	7.31	7.84
HTNRS 40175-031018				10		10,000	4.66°	—	10.79	11.23	11.61	12.46
HTNRS 40175-031518				15		10,000	3.49°	—	15.84	16.43	16.99	18.24
HTNRS 40175-032018				20		10,000	2.78°	—	20.89	21.63	22.38	No Interference
HTNRS 40175-033018				30		12,000	1.99°	—	30.98	32.04	No Interference	No Interference
HTNRS 40175-034018				40		14,000	1.54°	—	41.06	42.44	No Interference	No Interference
HTNRS 40175-035018				50		15,000	1.26°	—	51.11	No Interference	No Interference	No Interference
HTNRS 4020-052008	2	R0.5	0.4°	20	A	11,000	2.48°	20.86	21.60	22.30	23.06	No Interference
HTNRS 4020-052608				26		11,000	1.98°	26.92	27.83	28.75	No Interference	No Interference
HTNRS 4020-053008				30		11,000	1.75°	30.95	31.98	33.04	No Interference	No Interference
HTNRS 4020-053608				36		14,000	1.49°	37.00	38.22	No Interference	No Interference	No Interference
HTNRS 4020-054008			40	14,000		1.35°	41.03	42.37	No Interference	No Interference	No Interference	
HTNRS 4020-051018			0.9°	10		11,000	4.33°	—	10.84	11.25	11.63	12.46
HTNRS 4020-051518				15		11,000	3.21°	—	15.88	16.45	17.01	18.25
HTNRS 4020-052018				20		11,000	2.54°	—	20.93	21.66	22.39	No Interference
HTNRS 4020-052518				25		11,000	2.11°	—	25.97	26.86	27.77	No Interference
HTNRS 4020-053018				30		11,000	1.80°	—	31.01	32.06	No Interference	No Interference
HTNRS 4020-053518				35		14,000	1.57°	—	36.05	37.26	No Interference	No Interference
HTNRS 4020-054018				40		14,000	1.39°	—	41.09	No Interference	No Interference	No Interference
HTNRS 4020-054518			45	15,000		1.25°	—	46.10	No Interference	No Interference	No Interference	
HTNRS 4020-055018			50	15,000		1.14°	—	51.14	No Interference	No Interference	No Interference	
HTNRS 4020-053028			1.4°	30		11,000	1.85°	—	—	31.07	No Interference	No Interference
HTNRS 4020-054028				40		14,000	1.43°	—	—	No Interference	No Interference	No Interference
HTNRS 4020-053038				1.9°		30	12,000	3.39°	—	—	—	31.12
HTNRS 4020-054038			40			15,000	2.69°	—	—	—	41.19	No Interference
HTNRS 4020-053058			2.9°	30		12,000	3.58°	—	—	—	—	31.23
HTNRS 4020-054258				42		16,500	2.74°	—	—	—	—	No Interference

- 4 Flutes
- 3mm Shank V Series
- UDC-PCD Series
- CBN Series
- Square
- Square
- Long Neck Square
- Radius
- Radius
- Long Neck Radius
- Taper Neck Radius
- Ball / Long Shank Ball
- Ball
- Long Neck Ball
- Taper Neck Ball
- Taper
- Taper
- Barrel
- Spiral V Cutter
- Drill
- Technical Data

Model Number	Outside Diameter ϕD	Corner Radius CR	Neck Taper Angle TN	Neck Length ℓ_2	Effective Length ℓ_1	Length of Cut ℓ	Neck Diameter ϕd_1	Shank Taper Angle Bta	Overall Length L	Shank Diameter ϕd																			
HTNRS 4030-082008	3	R0.8	0.4°	20	—	3	—	16°	60	6																			
HTNRS 4030-082608				26					60	6																			
HTNRS 4030-083008				30					70	6																			
HTNRS 4030-083608				36					80	6																			
HTNRS 4030-084008				40					80	6																			
HTNRS 4030-082018			20	R0.8					0.9°	25	4.5	2.89	—	60	6														
HTNRS 4030-082518			25							60				6															
HTNRS 4030-083018			30							70				6															
HTNRS 4030-083518			35							80				6															
HTNRS 4030-084018			40							80				6															
HTNRS 4030-085018			50						90	6																			
HTNRS 4030-086018			60						100	6																			
HTNRS 4030-083028			30						R1	1.4°				40	6	3.8	16°	70	6										
HTNRS 4030-084028			40											80				6											
HTNRS 4030-083038			30							1.9°				40				9	5.8	—	—	70	6						
HTNRS 4030-084038			40											80								6							
HTNRS 4030-083358	33	2.9°	40		9	5.8	—	—		80				6															
HTNRS 4040-102508	25		R1							0.4°				30								—	—	16°	80	6			
HTNRS 4040-103008	30	70												6															
HTNRS 4040-103508	35	80												6															
HTNRS 4040-104008	40	80												6															
HTNRS 4040-104508	45	90		6																									
HTNRS 4040-105008	50	90		6																									
HTNRS 4040-102018	20	R1		0.9°						25	6	3.8	16°	60											6				
HTNRS 4040-102518	25									60				6															
HTNRS 4040-103018	30									70				6															
HTNRS 4040-103518	35									80				6															
HTNRS 4040-104018	40									80				6															
HTNRS 4040-105018	50			90					6																				
HTNRS 4040-106018	60			100					6																				
HTNRS 4040-104928	49			1.4°					60	9				5.8	—	—	90	6											
HTNRS 4040-106028	60								100								8												
HTNRS 4040-103038	30			1.9°	67	9	5.8	—	—								70	8											
HTNRS 4040-106738	67		120		8																								
HTNRS 4040-104558	45		2.9°	45	9												5.8	—	—	90	8								
HTNRS 4060-152018	20			R1.5																0.9°	30	6	—	16°	60	8			
HTNRS 4060-153018	30		70																		8								
HTNRS 4060-154018	40		80																		8								
HTNRS 4060-155018	50		90																		8								
HTNRS 4060-156018	60	100	8																										
HTNRS 4060-155128	51	1.4°	39								9	5.8	—							—	90				8				
HTNRS 4060-153938	39		80																		8								
HTNRS 4060-156938	69	2.9°	47																		9				5.8	—	—	110	10
HTNRS 4060-154758	47		90																									10	

φ3mm Shank V Series

UDC-PCD Series

CBN Series

Square
Long Neck Square

Radius
Long Neck Radius
Taper Neck Radius

Ball / Long Shank Ball
Long Neck Ball
Taper Neck Ball

Taper

Barrel

Spiral V Cutter

Drill

Technical Data

Unit (mm)

Model Number	Outside Diameter ϕD	Corner Radius CR	Neck Taper Angle TN	Neck Length ℓ_2	Shape	Suggested Retail Price ¥	Interference Angle	Effective Length by Inclined Angles — : Interference						
								30'	1°	1°30'	2°	3°		
HTNRS 4030-082008	3	R0.8	0.4°	20	A	12,000	3.48°	20.88	21.60	22.30	23.05	24.72		
HTNRS 4030-082608				26		12,000	2.82°	26.94	27.84	28.74	29.72	No Interference		
HTNRS 4030-083008				30		12,000	2.51°	30.97	31.99	33.04	34.16	No Interference		
HTNRS 4030-083608				36		14,000	2.14°	37.02	38.22	39.48	40.82	No Interference		
HTNRS 4030-084008				40		14,000	1.96°	41.05	42.38	43.78	No Interference	No Interference		
HTNRS 4030-082018			20	R1		0.9°	12,000	3.56°	—	20.98	21.69	22.41	24.03	
HTNRS 4030-082518			25				12,000	2.99°	—	26.02	26.89	27.79	No Interference	
HTNRS 4030-083018			30				12,000	2.57°	—	31.06	32.09	33.18	No Interference	
HTNRS 4030-083518			35				14,000	2.25°	—	36.10	37.29	38.56	No Interference	
HTNRS 4030-084018			40				14,000	2.01°	—	41.13	42.49	43.94	No Interference	
HTNRS 4030-085018			50			15,000	1.65°	—	51.18	52.87	No Interference	No Interference		
HTNRS 4030-086018			60			16,000	1.40°	—	61.25	No Interference	No Interference	No Interference		
HTNRS 4030-083028			30			B	1.4°	12,000	2.64°	—	—	31.14	32.19	No Interference
HTNRS 4030-084028			40					14,000	2.06°	—	—	41.21	42.61	No Interference
HTNRS 4030-083038			30				1.9°	12,000	2.71°	—	—	—	31.21	No Interference
HTNRS 4030-084038			40					14,000	2.12°	—	—	—	41.28	No Interference
HTNRS 4030-083358			33				C	2.9°	16,500	2.64°	—	—	—	No Interference
HTNRS 4040-102508			4				R1	0.4°	25	A	12,000	2.12°	25.49	26.28
HTNRS 4040-103008	30	12,000			1.80°				30.52		31.48	32.50	No Interference	No Interference
HTNRS 4040-103508	35	14,000			1.57°				35.55		36.67	37.87	No Interference	No Interference
HTNRS 4040-104008	40	14,000			1.39°	40.58			41.87		No Interference	No Interference	No Interference	
HTNRS 4040-104508	45	15,000			1.24°	45.61			47.06		No Interference	No Interference	No Interference	
HTNRS 4040-105008	50	15,000			1.13°	50.63		52.24	No Interference		No Interference	No Interference		
HTNRS 4040-102018	20	0.9°		12,000	2.64°	—		20.57	21.23		21.93	No Interference		
HTNRS 4040-102518	25			12,000	2.18°	—		25.60	26.43		27.32	No Interference		
HTNRS 4040-103018	30			12,000	1.85°	—		30.64	31.63		No Interference	No Interference		
HTNRS 4040-103518	35			14,000	1.61°	—		35.67	36.83		No Interference	No Interference		
HTNRS 4040-104018	40			14,000	1.42°	—		40.70	No Interference		No Interference	No Interference		
HTNRS 4040-105018	50			15,000	1.16°	—		50.75	No Interference		No Interference	No Interference		
HTNRS 4040-106018	60			16,000	0.98°	—		No Interference	No Interference		No Interference	No Interference		
HTNRS 4040-104928	49			C	1.4°	15,000		1.21°	—		—	No Interference	No Interference	No Interference
HTNRS 4040-106028	60	B		17,000	1.88°	—		—	60.94		No Interference	No Interference		
HTNRS 4040-103038	30			16,000	3.46°	—		—	—		30.89	33.13		
HTNRS 4040-106738	67	C		23,000	1.75°	—		—	—		No Interference	No Interference		
HTNRS 4040-104558	45			18,000	2.62°	—		—	—		—	No Interference		
HTNRS 4060-152018	6	R1.5	0.9°	20	A	17,000	2.69°	—	20.63	21.28	21.97	No Interference		
HTNRS 4060-153018				30		17,000	1.88°	—	30.70	31.68	No Interference	No Interference		
HTNRS 4060-154018				40		17,000	1.44°	—	40.76	No Interference	No Interference	No Interference		
HTNRS 4060-155018				50		17,000	1.17°	—	50.83	No Interference	No Interference	No Interference		
HTNRS 4060-156018				60		18,000	0.98°	—	No Interference	No Interference	No Interference	No Interference		
HTNRS 4060-155128			51	C		1.4°	17,000	1.18°	—	—	No Interference	No Interference	No Interference	
HTNRS 4060-153938			39			17,000	1.55°	—	—	—	No Interference	No Interference		
HTNRS 4060-156938			69			23,500	1.71°	—	—	—	No Interference	No Interference		
HTNRS 4060-154758			47			23,000	2.53°	—	—	—	—	No Interference		

4 Flutes

$\phi 3\text{mm}$ Shank
V Series

UDC-PCD
Series

CBN
Series

Square

Long Neck
Square

Radius

Long Neck
Radius

Taper Neck
Radius

Ball / Long
Shank Ball

Long Neck
Ball

Taper Neck
Ball

Taper

Barrel

Spiral
V Cutter

Drill

Technical Data

Milling Conditions for HTNRS

WORK MATERIAL					PREHARDENED STEELS / HARDENED STEELS NAK / SKD (30~45HRC)				HARDENED STEELS SKD / SKT (45~55HRC)				HARDENED STEELS SKD / SKH (55~65HRC)									
Model Number	Outside Diameter (mm)	Corner Radius (mm)	Neck Taper Angle TN	Neck Length (mm)	Spindle Speed (min ⁻¹)	Feed Rate (mm/min)	a _p Axial Depth (mm)	a _e Radial Depth (mm)	Spindle Speed (min ⁻¹)	Feed Rate (mm/min)	a _p Axial Depth (mm)	a _e Radial Depth (mm)	Spindle Speed (min ⁻¹)	Feed Rate (mm/min)	a _p Axial Depth (mm)	a _e Radial Depth (mm)						
4010-020608	1	R0.2	0.4°	6	20,000	2,600	0.06	0.44	11,600	980	0.029	0.23	8,900	530	0.012	0.09						
4010-021008				10	19,000	2,450	0.03	0.42	11,000	920	0.015	0.21	8,500	480	0.008	0.07						
4010-022008				20	17,000	2,150	0.008	0.37	9,700	800	0.005	0.18	7,600	400	0.004	0.05						
4010-023008				30	12,000	1,500	0.003	0.26	7,200	570	0.002	0.12	6,000	310	0.002	0.04						
4010-020618			1.25	R0.2	0.9°	6	20,000	2,600	0.06	0.45	11,600	980	0.029	0.24	8,900	530	0.012	0.1				
4010-021018						10	19,000	2,450	0.03	0.43	11,000	920	0.015	0.22	8,500	480	0.008	0.075				
4010-021518						15	18,500	2,400	0.02	0.41	10,700	880	0.01	0.21	8,200	450	0.006	0.065				
4010-022018						20	18,000	2,300	0.01	0.4	10,400	850	0.006	0.2	8,000	430	0.005	0.05				
4010-022518					25	17,000	2,150	0.008	0.38	9,900	800	0.005	0.19	7,700	410	0.004	0.05					
4010-023018					30	16,000	2,000	0.007	0.35	9,400	750	0.004	0.18	7,400	390	0.004	0.05					
4010-023518					35	15,000	1,850	0.006	0.32	8,800	700	0.004	0.16	7,000	370	0.003	0.05					
4010-024018					40	14,000	1,750	0.005	0.3	8,300	660	0.003	0.15	6,700	350	0.003	0.05					
4010-025018					50	12,000	1,500	0.003	0.28	7,200	570	0.002	0.14	6,000	310	0.002	0.05					
4010-020628					1.25	R0.2	1.4°	6	20,000	2,600	0.06	0.46	11,600	980	0.029	0.25	8,900	530	0.012	0.11		
4010-021028								10	20,000	2,600	0.04	0.45	11,400	960	0.02	0.24	8,750	510	0.01	0.08		
4010-022028								20	19,000	2,400	0.02	0.4	10,900	900	0.01	0.2	8,400	470	0.005	0.06		
4010-023028								30	18,000	2,300	0.01	0.4	10,400	850	0.006	0.2	8,000	430	0.005	0.05		
40125-020618							1.25	R0.2	0.9°	6	16,000	2,600	0.075	0.56	9,200	990	0.036	0.3	7,100	540	0.015	0.12
40125-021018										10	16,000	2,600	0.057	0.55	9,200	990	0.027	0.29	7,100	540	0.012	0.1
40125-021518										15	15,500	2,500	0.04	0.53	8,900	950	0.019	0.27	6,900	500	0.01	0.08
40125-022018	20	15,000	2,400	0.022						0.51	8,700	900	0.011	0.26	6,700	470	0.007	0.07				
40125-023018	30	14,400	2,300	0.011	0.47	8,300				860	0.006	0.23	6,400	440	0.005	0.06						
40125-024018	40	12,800	2,000	0.008	0.42	7,500				750	0.004	0.21	5,900	390	0.004	0.06						
40125-025018	50	11,000	1,700	0.006	0.37	6,500				650	0.003	0.19	5,300	350	0.003	0.06						
4015-030608	1.5	R0.3	0.4°	6	13,500	2,600				0.09	0.67	7,800	990	0.043	0.36	6,000	540	0.018	0.15			
4015-031008				10	13,500	2,600	0.083	0.66	7,700	980	0.04	0.35	6,000	540	0.017	0.13						
4015-032008				20	12,500	2,400	0.028	0.61	7,000	880	0.015	0.31	5,500	460	0.009	0.09						
4015-033008				30	12,000	2,300	0.012	0.55	6,900	860	0.007	0.27	5,350	440	0.006	0.07						
4015-030618			1.5	R0.3	0.9°	6	13,500	2,600	0.09	0.67	7,800	990	0.043	0.36	6,000	540	0.018	0.15				
4015-031018						10	13,500	2,600	0.083	0.67	7,800	990	0.04	0.36	6,000	540	0.017	0.14				
4015-031518						15	13,000	2,500	0.055	0.65	7,500	950	0.029	0.34	5,800	500	0.013	0.12				
4015-032018						20	12,500	2,400	0.035	0.63	7,200	900	0.018	0.32	5,600	470	0.01	0.1				
4015-032518					25	12,500	2,400	0.025	0.61	7,000	880	0.013	0.31	5,500	460	0.009	0.08					
4015-033018					30	12,000	2,300	0.015	0.6	6,900	860	0.008	0.3	5,350	440	0.007	0.07					
4015-034018					40	12,000	2,300	0.012	0.55	6,900	860	0.007	0.27	5,350	440	0.006	0.07					
4015-035018					50	10,500	2,000	0.009	0.5	6,100	740	0.005	0.25	4,850	380	0.005	0.07					
4015-030628			1.5	R0.3	1.4°	6	13,500	2,600	0.09	0.67	7,800	990	0.043	0.36	6,000	540	0.018	0.15				
4015-031028						10	13,500	2,600	0.085	0.67	7,800	990	0.04	0.36	6,000	540	0.017	0.15				
4015-032028						20	13,000	2,500	0.05	0.63	7,300	920	0.02	0.33	5,600	480	0.011	0.11				
4015-033028					30	12,500	2,400	0.025	0.61	7,000	880	0.013	0.31	5,500	460	0.009	0.08					

- φ3mm Shank V Series
- UDC-PCD Series
- CBN Series
- Square
- Long Neck Square
- Radius
- Long Neck Radius
- Taper Neck Radius
- Ball / Long Shank Ball
- Long Neck Ball
- Taper Neck Ball
- Taper
- Barrel
- Spiral V Cutter
- Drill
- Technical Data

Milling Conditions for HTNRS

WORK MATERIAL				PREHARDENED STEELS / HARDENED STEELS NAK / SKD (30~45HRC)				HARDENED STEELS SKD / SKT (45~55HRC)				HARDENED STEELS SKD / SKH (55~65HRC)							
Model Number	Outside Diameter (mm)	Corner Radius (mm)	Neck Taper Angle TN	Neck Length (mm)	Spindle Speed (min ⁻¹)	Feed Rate (mm/min)	a _p Axial Depth (mm)	a _e Radial Depth (mm)	Spindle Speed (min ⁻¹)	Feed Rate (mm/min)	a _p Axial Depth (mm)	a _e Radial Depth (mm)	Spindle Speed (min ⁻¹)	Feed Rate (mm/min)	a _p Axial Depth (mm)	a _e Radial Depth (mm)			
40175-030618	1.75	R0.3	0.9°	6	11,500	2,600	0.105	0.78	6,600	990	0.05	0.42	5,100	540	0.021	0.17			
40175-031018				10	11,500	2,600	0.105	0.78	6,600	990	0.05	0.42	5,100	540	0.021	0.17			
40175-031518				15	11,500	2,600	0.07	0.76	6,500	950	0.037	0.4	5,000	510	0.017	0.14			
40175-032018				20	11,000	2,450	0.047	0.74	6,400	920	0.024	0.38	4,900	480	0.013	0.12			
40175-033018				30	11,000	2,450	0.027	0.71	6,400	920	0.014	0.36	4,900	480	0.01	0.1			
40175-034018				40	10,000	2,200	0.016	0.67	5,800	820	0.009	0.33	4,450	420	0.008	0.08			
40175-035018				50	10,000	2,200	0.013	0.62	5,800	820	0.008	0.31	4,450	420	0.007	0.08			
4020-052008				2	R0.5	0.4°	20	9,500	2,450	0.06	0.85	5,500	920	0.025	0.43	4,250	480	0.015	0.13
4020-052608	26	9,500	2,450				0.04	0.83	5,500	920	0.021	0.42	4,250	480	0.013	0.12			
4020-053008	30	9,000	2,300				0.03	0.79	5,400	880	0.016	0.41	4,100	450	0.012	0.11			
4020-053608	36	9,000	2,300				0.02	0.75	5,200	850	0.011	0.39	4,000	430	0.01	0.1			
4020-054008	40	9,000	2,300				0.02	0.7	5,200	850	0.01	0.38	4,000	430	0.009	0.1			
4020-051018	0.9°	10	10,000				2,600	0.12	0.9	5,800	990	0.057	0.49	4,450	540	0.024	0.2		
4020-051518		15	10,000				2,600	0.09	0.88	5,600	950	0.044	0.47	4,350	510	0.02	0.17		
4020-052018		20	9,500				2,450	0.06	0.86	5,500	920	0.03	0.45	4,250	480	0.016	0.15		
4020-052518		25	9,500			2,450	0.05	0.85	5,500	920	0.025	0.43	4,250	480	0.015	0.13			
4020-053018		30	9,500			2,450	0.04	0.83	5,500	920	0.021	0.42	4,250	480	0.013	0.12			
4020-053518		35	9,000			2,300	0.03	0.81	5,300	880	0.016	0.41	4,100	450	0.012	0.11			
4020-054018		40	9,000			2,300	0.02	0.8	5,200	850	0.012	0.4	4,000	430	0.01	0.1			
4020-054518		45	9,000			2,300	0.02	0.75	5,200	850	0.011	0.39	4,000	430	0.01	0.1			
4020-055018	50	9,000	2,300			0.017	0.75	5,200	850	0.01	0.38	4,000	430	0.009	0.1				
4020-053028	1.4°	30	9,500			2,450	0.05	0.85	5,500	920	0.025	0.43	4,250	480	0.015	0.13			
4020-054028		40	9,500			2,450	0.04	0.83	5,500	920	0.02	0.42	4,250	480	0.013	0.12			
4020-053038		1.9°	30			9,500	2,450	0.06	0.85	5,500	920	0.03	0.43	4,250	480	0.017	0.14		
4020-054038			40			9,500	2,450	0.05	0.85	5,500	920	0.025	0.43	4,250	480	0.015	0.13		
4020-053058	2.9°	30	9,500			2,450	0.07	0.85	5,500	920	0.035	0.45	4,250	480	0.017	0.16			
4020-054258		42	9,500			2,450	0.06	0.85	5,500	920	0.03	0.45	4,250	480	0.016	0.15			
4030-082008	3	R0.8	0.4°			20	6,500	2,500	0.12	1.06	3,900	960	0.05	0.58	3,200	550	0.029	0.25	
4030-082608						26	6,300	2,400	0.08	1.04	3,800	940	0.038	0.56	3,100	520	0.025	0.22	
4030-083008						30	6,300	2,400	0.064	1.01	3,800	920	0.034	0.55	3,100	510	0.022	0.21	
4030-083608						36	6,300	2,400	0.05	1	3,800	920	0.028	0.52	3,100	510	0.02	0.19	
4030-084008						40	6,300	2,400	0.04	0.98	3,800	920	0.023	0.51	3,100	510	0.018	0.17	
4030-082018						0.9°	20	6,700	2,600	0.13	1.07	4,000	1,000	0.065	0.6	3,300	590	0.034	0.28
4030-082518							25	6,500	2,500	0.1	1.05	3,900	960	0.05	0.58	3,200	550	0.029	0.25
4030-083018							30	6,300	2,400	0.072	1.03	3,800	920	0.038	0.56	3,100	510	0.024	0.22
4030-083518			35	6,300	2,400		0.064	1.01	3,800	920	0.034	0.55	3,100	510	0.022	0.21			
4030-084018			1.4°	40	6,300	2,400	0.056	1	3,800	920	0.03	0.54	3,100	510	0.021	0.2			
4030-085018				50	6,300	2,400	0.04	0.98	3,800	920	0.023	0.51	3,100	510	0.018	0.17			
4030-086018				60	6,000	2,300	0.024	0.96	3,600	870	0.015	0.49	2,900	470	0.015	0.15			
4030-083028				1.9°	30	6,500	2,500	0.09	1.03	3,900	960	0.045	0.57	3,200	550	0.03	0.24		
4030-084028					40	6,300	2,400	0.06	1.01	3,800	920	0.035	0.55	3,100	510	0.02	0.21		
4030-083038				2.9°	30	6,500	2,500	0.1	1.05	3,900	960	0.05	0.58	3,200	550	0.03	0.25		
4030-084038					40	6,300	2,400	0.07	1.03	3,800	920	0.04	0.56	3,100	510	0.025	0.22		
4030-083358				33	6,700	2,500	0.12	1.07	3,900	1,000	0.06	0.6	3,200	590	0.03	0.28			

4 Flutes

Ø3mm Shank V Series

UDC-PCD Series

CBN Series

Square

Square

Long Neck Square

Radius

Radius

Long Neck Radius

Taper Neck Radius

Ball

Ball / Long Shank Ball

Long Neck Ball

Taper Neck Ball

Taper

Taper

Barrel

Spiral V Cutter

Drill

Technical Data

WORK MATERIAL					PREHARDENED STEELS / HARDENED STEELS NAK / SKD (30~45HRC)				HARDENED STEELS SKD / SKT (45~55HRC)				HARDENED STEELS SKD / SKH (55~65HRC)							
Model Number	Outside Diameter (mm)	Corner Radius (mm)	Neck Taper Angle TN	Neck Length (mm)	Spindle Speed (min ⁻¹)	Feed Rate (mm/min)	a _p Axial Depth (mm)	a _e Radial Depth (mm)	Spindle Speed (min ⁻¹)	Feed Rate (mm/min)	a _p Axial Depth (mm)	a _e Radial Depth (mm)	Spindle Speed (min ⁻¹)	Feed Rate (mm/min)	a _p Axial Depth (mm)	a _e Radial Depth (mm)				
4040-102508	4	R1	0.4°	25	5,000	2,600	0.17	1.42	3,000	1,000	0.085	0.8	2,450	600	0.045	0.38				
4040-103008				30	5,000	2,600	0.13	1.39	2,900	960	0.065	0.77	2,400	540	0.038	0.34				
4040-103508				35	4,800	2,450	0.09	1.37	2,900	920	0.048	0.75	2,350	480	0.032	0.3				
4040-104008				40	4,800	2,450	0.08	1.35	2,900	920	0.043	0.74	2,350	480	0.03	0.28				
4040-104508				45	4,800	2,450	0.07	1.33	2,900	920	0.038	0.72	2,350	480	0.028	0.26				
4040-105008				50	4,800	2,450	0.06	1.32	2,900	920	0.034	0.7	2,350	480	0.026	0.25				
4040-102018			4	R1	0.9°	20	5,000	2,600	0.19	1.44	3,000	1,000	0.095	0.82	2,450	600	0.048	0.4		
4040-102518						25	5,000	2,600	0.17	1.42	3,000	1,000	0.085	0.8	2,450	600	0.045	0.38		
4040-103018						30	5,000	2,600	0.15	1.41	3,000	1,000	0.076	0.79	2,450	600	0.042	0.36		
4040-103518						35	4,800	2,450	0.12	1.39	2,900	960	0.062	0.77	2,400	540	0.037	0.33		
4040-104018						40	4,800	2,450	0.09	1.37	2,900	920	0.048	0.75	2,350	480	0.032	0.3		
4040-105018						50	4,800	2,450	0.08	1.35	2,900	920	0.043	0.72	2,350	480	0.029	0.27		
4040-106018					1.4°	60	4,800	2,450	0.06	1.32	2,900	920	0.034	0.7	2,350	480	0.026	0.25		
4040-104928						49	4,800	2,500	0.1	1.37	2,900	960	0.05	0.74	2,350	540	0.035	0.28		
4040-106028					60	4,800	2,500	0.08	1.35	2,900	960	0.04	0.72	2,350	540	0.03	0.27			
4040-103038					1.9°	30	5,000	2,600	0.15	1.42	3,000	1,000	0.08	0.8	2,450	600	0.045	0.38		
4040-106738						67	4,800	2,500	0.12	1.4	2,900	960	0.05	0.78	2,350	540	0.03	0.35		
4040-104558					45	5,000	2,600	0.15	1.41	3,000	1,000	0.08	0.79	2,450	600	0.045	0.36			
4060-152018					6	R1.5	0.9°	20	3,350	2,600	0.28	2.16	2,000	1,000	0.14	1.24	1,650	600	0.072	0.6
4060-153018								30	3,350	2,600	0.28	2.16	2,000	1,000	0.14	1.24	1,650	600	0.072	0.6
4060-154018	40	3,350	2,600	0.26				2.14	2,000	1,000	0.131	1.21	1,650	600	0.068	0.57				
4060-155018	50	3,350	2,600	0.2				2.1	2,000	1,000	0.103	1.17	1,650	600	0.058	0.51				
4060-156018	60	3,150	2,400	0.14				2.06	1,900	920	0.075	1.12	1,550	510	0.048	0.45				
4060-155128	1.4°	51	3,350	2,600			0.2	2.1	2,000	1,000	0.1	1.17	1,650	600	0.058	0.51				
4060-153938		39	3,350	2,600			0.26	2.14	2,000	1,000	0.13	1.21	1,650	600	0.068	0.57				
4060-156938	1.9°	69	3,150	2,400			0.14	2.06	1,900	920	0.075	1.12	1,550	510	0.048	0.45				
4060-154758		47	3,350	2,600			0.26	2.14	2,000	1,000	0.13	1.21	1,650	600	0.068	0.57				

Side Milling

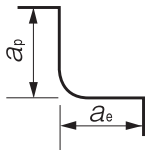

Note:

- Decrease both spindle speed and feed rate proportionally when the milling parameters exceed the machine's maximum spindle speed.
- Every coolant offers stable milling.

Milling Example of Taper Slotting

HTNRS $\phi 2 \times CR0.5 \times$ Neck Length 20 · 30 · 40

SKD61 (45HRC)

4 Flutes

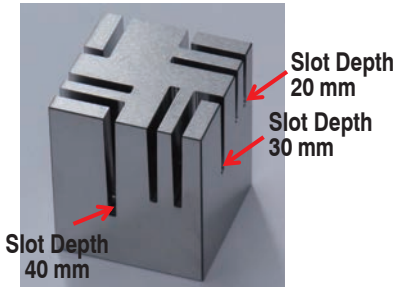

- Work Size : 50 × 50 × 60 mm
- Inclined Angle : 1°
- Slot Length : 27 mm (L Shape Slot)
21 mm (Straight Slot)
- Slot Width : 2.6 mm (Bottom)
- Slot Depth : 20, 30, 40 mm
- Coolant : Water Soluble

① Performance compared with straight neck type...Depth 20 mm L shape slotting

Milling Process	Tool	Neck Shape Helix Angle	Tool Size (mm)	Spindle Speed (min ⁻¹)	Feed Rate (mm/min)	a_p (mm)	Cycle Time
Roughing	HTNRS 4020-052018	Taper Neck 0.9° 45° Helix Angle	$\phi 2 \times CR0.5 \times$ Neck Length 20	9,500	2,450	0.064	20 min 18 sec
Roughing	HLRS 4020-05-200	Straight Neck 30° Helix Angle	$\phi 2 \times CR0.5 \times$ Effective Length 20	7,000	800	0.025	1 h 30 min 9 sec

Taper neck is 7 times more efficient in 20 mm depth slotting !

② Depth 40 mm L shape slotting

Milling Process	Tool	Neck Shape Helix Angle	Tool Size (mm)	Spindle Speed (min ⁻¹)	Feed Rate (mm/min)	a_p (mm)	Cycle Time
Roughing	HTNRS 4020-052018	Taper Neck 0.9° 45° Helix Angle	$\phi 2 \times CR0.5 \times$ Neck Length 20 mm	9,500	2,450	0.064	27 min 8 sec
Roughing	HTNRS 4020-053018		$\phi 2 \times CR0.5 \times$ Neck Length 30 mm	9,500	2,450	0.047	15 min 32 sec
Roughing	HTNRS 4020-054018		$\phi 2 \times CR0.5 \times$ Neck Length 40 mm	9,000	2,300	0.02	40 min 26 sec
Finishing				4,500	500	0.0001 (Cusp Height)	4 h 28 min 50 sec

Slotting image of depth 40 mm

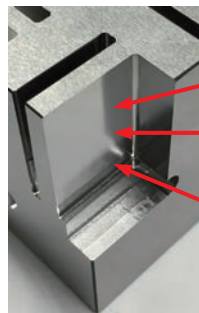
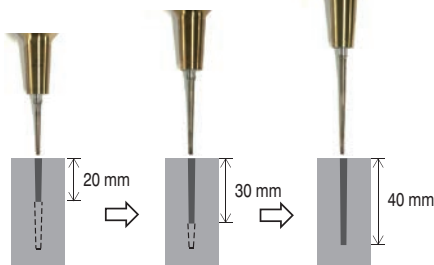

Depth 20 mm
Ra : 0.287 μ m

Depth 30 mm
Ra : 0.241 μ m

Depth 40 mm
Ra : 0.274 μ m

40 mm slot depth roughing process completed in 1h 23 min ! Excellent surface finishing !

$\phi 3$ mm Shank
V Series

UDC-PCD
Series

CBN
Series

Square

Long Neck
Square

Radius

Long Neck
Radius

Taper Neck
Radius

Ball / Long
Shank Ball

Long Neck
Ball

Taper Neck
Ball

Taper

Barrel

Spiral
V Cutter

Drill

Technical Data



Size R0.05~R3

HGB

Super
MG

HMGC
COAT

30°

R
±0.002

R
±0.003

R
±0.005

Shank Dia
0/-0.004

R0.05~R0.075 R0.1~R2 R2.5~R3

Material Applications (★ Highly Recommended ● Recommended ○ Suggested)

Work Material																	
Carbon Steels S45C S55C	Alloy Steels SK / SCM SUS	Prehardened Steels NAK HPM	Hardened Steels					Cast Iron	Aluminum Alloys	Graphite	Copper	Plastics	Glass Filled Plastics	Titanium Alloys	Heat Resistant Alloys	Cemented Carbide	Hard Brittle (Non-Metallic) Materials
			~50HRC	~55HRC	~60HRC	~65HRC	~70HRC										
		○	●	●	●	★	★										

Features

Newly developed "HMGCOAT", carbide grade and tool shape offer higher wear/chipping resistance as compared to conventional tools.

Achieves longer tool life and highly precise milling on hard materials.

High Precision Diameter Tolerance / Radius Accuracy / Shank Diameter Tolerance

Radius of Ball Nose	Diameter Tolerance	Ball Radius Accuracy	Shank Diameter Tolerance
R0.05 ~ R0.075	0/-0.008	±0.002	0/-0.004 (h4)
R0.1 ~ R1.25		±0.003	
R1.5 ~ R2	0/-0.01	±0.005	
R2.5 ~ R3			

Shank diameter tolerance h4!

The shank taper angle shown is not an exact value and to avoid contact with the workpiece, we recommend the user controls the precise value of this angle. Shank taper angle should not make contact with the work piece.

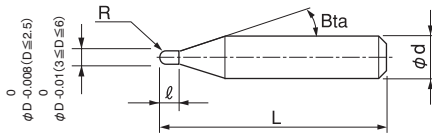

Ball series for Steels

(★ Highly Recommended ● Recommended ○ Suggested)

Number of Flutes	Model Number	Features	Ball tip design	Copper	Carbon Steels	Pre hardened Steels	HARDENED STEELS					Alloy Steels	Aluminum Alloys	Plastics	Titanium/Heat Resistant Alloys	Page
							~50 HRC	~55 HRC	~60 HRC	~65 HRC	~70 HRC					
2 Flutes	HGB	Best suited for Hard Materials	Super Negative			○	●	●	●	★	★					422
	HSB HSB-S	For Hard Materials	Negative		○	○	●	●	●	○		○			○	424 428
	HBL	Multi-purpose	Positive		●	○	●	●	○			○				430
	CSEB	Multi-purpose Excellent surface quality	Standard		●	●	●	●	○			●	●		○	432
3 Flutes	CFB	Multi-purpose Excellent surface quality	Positive		●	●	●	●			●	●	○	●	442	
4 Flutes	HFB HFB-S	For Hard Materials	Negative				●	●	●	●						452 453

Total 20 models

Unit (mm)

Model Number	Radius of Ball Nose R	Length of Cut ℓ	Shank Taper Angle Bta	Overall Length L	Shank Diameter ϕd	Suggested Retail Price ¥
HGB 2001-0010	R0.05	0.1	16°	50	4	12,960
HGB 20015-0015	R0.075	0.15	16°	50	4	12,600
HGB 2002-0030	R0.1	0.3	16°	50	4	9,120
HGB 2003-0030	R0.15	0.3	16°	50	4	7,440
HGB 2003-0045		0.45		50	4	7,440
HGB 2004-0040	R0.2	0.4	16°	50	4	5,040
HGB 2004-0060		0.6		50	4	5,040
HGB 2005-0050	R0.25	0.5	16°	50	4	4,680
HGB 2005-0075		0.75		50	4	4,680
HGB 2006-0060	R0.3	0.6	16°	50	4	4,560
HGB 2006-0090		0.9		50	4	4,560
HGB 2008-0120	R0.4	1.2	16°	50	4	4,560
HGB 2010-0150	R0.5	1.5	16°	50	4	4,150
HGB 2015-0225	R0.75	2.25	16°	50	4	5,040
HGB 2020-0300	R1	3	16°	50	4	3,720
HGB 2025-0375	R1.25	3.75	16°	50	4	6,370
HGB 2030-0450	R1.5	4.5	16°	50	6	4,560
HGB 2040-0600	R2	6	16°	50	6	5,160
HGB 2050-0750	R2.5	7.5	16°	50	6	6,240
HGB 2060-0900	R3	9	—	50	6	6,480

Milling Conditions for HGB

WORK MATERIAL			PREHARDENED STEELS HARDENED STEELS NAK / STAVAX (~55HRC)				HARDENED STEELS SKD11 (55~62HRC)				HARDENED STEELS HAP10 (62~66HRC)				HARDENED STEELS HAP72 (66~70HRC)			
Model Number	Radius of Ball Nose (mm)	Length of Cut (mm)	Spindle Speed (min ⁻¹)	Feed Rate (mm/min)	a_p Axial Depth (mm)	a_e Radial Depth (mm)	Spindle Speed (min ⁻¹)	Feed Rate (mm/min)	a_p Axial Depth (mm)	a_e Radial Depth (mm)	Spindle Speed (min ⁻¹)	Feed Rate (mm/min)	a_p Axial Depth (mm)	a_e Radial Depth (mm)	Spindle Speed (min ⁻¹)	Feed Rate (mm/min)	a_p Axial Depth (mm)	a_e Radial Depth (mm)
2001-0010	R0.05	0.1	48,000	200	0.005	0.01	48,000	200	0.005	0.01	48,000	150	0.003	0.006	40,000	120	0.002	0.004
20015-0015	R0.075	0.15	48,000	230	0.007	0.014	48,000	230	0.007	0.014	48,000	170	0.005	0.01	40,000	135	0.003	0.006
2002-0030	R0.1	0.3	44,000	250	0.01	0.03	42,000	250	0.01	0.03	40,000	200	0.008	0.024	36,000	150	0.006	0.018
2003-0030	R0.15	0.3	44,000	400	0.01	0.03	42,000	350	0.01	0.03	40,000	300	0.01	0.03	36,000	250	0.008	0.024
2003-0045		0.45	44,000	400	0.01	0.03	42,000	350	0.01	0.03	40,000	300	0.01	0.03	36,000	250	0.008	0.024
2004-0040	R0.2	0.4	44,000	600	0.015	0.045	42,000	550	0.015	0.045	40,000	500	0.013	0.036	36,000	350	0.01	0.027
2004-0060		0.6	44,000	600	0.015	0.045	42,000	550	0.015	0.045	40,000	500	0.013	0.036	36,000	350	0.01	0.027
2005-0050	R0.25	0.5	44,000	900	0.02	0.065	40,000	800	0.015	0.05	36,000	600	0.015	0.05	30,000	400	0.015	0.03
2005-0075		0.75	44,000	900	0.02	0.065	40,000	800	0.015	0.05	36,000	600	0.015	0.05	30,000	400	0.015	0.03
2006-0060	R0.3	0.6	40,000	1,400	0.045	0.15	36,000	1,200	0.025	0.13	32,000	1,000	0.02	0.1	25,000	600	0.02	0.1
2006-0090		0.9	40,000	1,400	0.045	0.15	36,000	1,200	0.025	0.13	32,000	1,000	0.02	0.1	25,000	600	0.02	0.1
2008-0120	R0.4	1.2	35,000	1,600	0.06	0.21	30,000	1,600	0.04	0.17	26,000	1,350	0.04	0.15	20,000	700	0.02	0.12
2010-0150	R0.5	1.5	30,000	1,750	0.2	0.4	24,000	2,000	0.1	0.3	21,000	1,750	0.05	0.2	16,000	875	0.05	0.2
2015-0225	R0.75	2.25	30,000	2,450	0.25	0.55	17,000	2,000	0.12	0.4	15,000	1,750	0.06	0.29	11,250	875	0.06	0.29
2020-0300	R1	3	28,000	2,900	0.3	0.7	14,000	2,100	0.15	0.5	14,700	2,160	0.1	0.35	11,040	1,080	0.08	0.35
2025-0375	R1.25	3.75	24,500	2,950	0.35	0.85	12,250	2,150	0.17	0.6	12,840	2,220	0.12	0.45	9,660	1,110	0.1	0.45
2030-0450	R1.5	4.5	21,000	3,000	0.4	1	10,500	2,200	0.2	0.7	11,040	2,280	0.15	0.55	8,280	1,140	0.12	0.55
2040-0600	R2	6	18,000	3,200	0.5	1.3	9,000	2,300	0.25	0.95	9,480	2,400	0.18	0.75	7,080	1,200	0.15	0.75
2050-0750	R2.5	7.5	15,600	3,500	0.5	1.5	7,800	2,500	0.25	1.05	8,160	2,520	0.2	0.85	6,120	1,260	0.15	0.85
2060-0900	R3	9	13,000	3,500	0.6	1.8	6,500	2,500	0.3	1.3	6,840	2,640	0.25	1	5,000	1,500	0.2	1

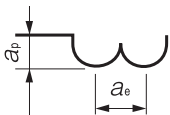

Note:

- Decrease the feed rate more than 50% from the milling parameters when slot milling.
- Decrease both spindle speed and feed rate proportionally when the milling parameters exceed the machines maximum speed, or when the tool is chattering and heats up to a red color.
- Every coolant offers stable milling.

Ø3mm Shank
V SeriesUDC-PCD
SeriesCBN
SeriesSquare
Long Neck
SquareRadius
Long Neck
RadiusTaper Neck
RadiusBall / Long
Shank BallLong Neck
BallTaper Neck
Ball

Taper

Barrel

Spiral
V Cutter

Drill

Technical Data



Size R0.03~R6

HSB



Material Applications (★ Highly Recommended ● Recommended ○ Suggested)

Work Material																	
Carbon Steels S45C S55C	Alloy Steels SK / SCM SUS	Prehardened Steels NAK HPM	Hardened Steels					Cast Iron	Aluminum Alloys	Graphite	Copper	Plastics	Glass Filled Plastics	Titanium Alloys	Heat Resistant Alloys	Cemented Carbide	Hard Brittle (Non-Metallic) Materials
			~50HRC	~55HRC	~60HRC	~65HRC	~70HRC										
○	○	●	●	●	●	○	○				○			○	○		

Features

Offers high efficiency, long tool life and excellent surface finish on hard materials over 40HRC.

HARDMAX coat offers heat resistance, durability and lubricity at a high level.

Every coolant offers stable milling.

Ball tip point is designed with a negative rake angle that minimizes wear and improves the target dimensions.

The low negative rake angle at the peripheral side of the ball offers an excellent surface finish and prevents deflection.

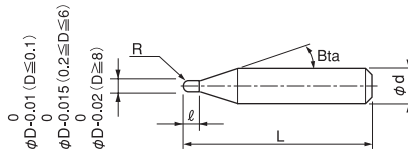

The shank taper angle shown is not an exact value and to avoid contact with the work piece, we recommend the user controls the precise value of this angle. Shank taper angle should not make contact with the work piece.

ATTENTION

HSB 1001-0020-6 (R0.05) is a taper ball end mill with half included angle 10° (See the right drawing).

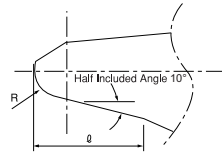

Radius of Ball Nose	Diameter Tolerance	Radius Accuracy	Helix Angle	Number of Flutes
R0.03 ~ R0.05	0/-0.01	±0.002	0°	2 Flutes *
R0.1 ~ R3	0/-0.015	±0.005	30°	
R4 ~ R6	0/-0.02	±0.007		

* Only HSB 1001-0020-6 has single flute.
R accuracy: ±0.005, Diameter tolerance: 0/-0.015

Total 71 models

Unit (mm)

Model Number	Radius of Ball Nose R	Length of Cut ℓ	Shank Taper Angle Bta	Overall Length L	Shank Diameter φd	Suggested Retail Price ¥
HSB 20006-0006	R0.03	0.06	11°	50	4	17,460
HSB 20008-0008	R0.04	0.08	11°	50	4	14,550
HSB 1001-0020-6	R0.05	0.2	11°	50	6	13,320
HSB 2001-0010	R0.05	0.1	11°	50	4	12,120
HSB 2002-0020-6	R0.1	0.2	16°	50	6	9,840
HSB 2002-0030		0.3		50	4	8,520
HSB 2003-0030		0.3		50	4	6,960
HSB 2003-0030-6	R0.15	0.3	16°	50	6	8,400
HSB 2003-0045		0.45		50	4	6,960
HSB 2004-0040		0.4		50	4	4,680
HSB 2004-0040-6	R0.2	0.4	16°	50	6	6,120
HSB 2004-0060		0.6		50	4	4,680
HSB 2005-0050		0.5		50	4	4,320
HSB 2005-0050-6	R0.25	0.5	16°	50	6	5,760
HSB 2005-0075		0.75		50	4	4,320

- φ3mm Shank V Series
- UDC-PCD Series
- CBN Series
- Square
- Long Neck Square
- Radius
- Long Neck Radius
- Taper Neck Radius
- Ball / Long Shank Ball
- Long Neck Ball
- Taper Neck Ball
- Taper
- Barrel
- Spiral V Cutter
- Drill
- Technical Data

Unit (mm)

Model Number	Radius of Ball Nose R	Length of Cut l	Shank Taper Angle $B\alpha$	Overall Length L	Shank Diameter ϕd	Suggested Retail Price ¥
HSB 2006-0060	R0.3	0.6	16°	50	4	4,200
HSB 2006-0060-6		0.6		50	6	5,520
HSB 2006-0090		0.9		50	4	4,200
HSB 2007-0100	R0.35	1	16°	50	4	8,000
HSB 2008-0080	R0.4	0.8	16°	50	4	4,200
HSB 2008-0080-6		0.8		50	6	5,520
HSB 2008-0120		1.2		50	4	4,200
HSB 2009-0130	R0.45	1.3	16°	50	4	8,000
HSB 2010-0100	R0.5	1	16°	50	4	3,840
HSB 2010-0100-6		1		50	6	5,160
HSB 2010-0150		1.5		50	4	3,840
HSB 2010-0250		2.5		50	4	3,840
HSB 2011-0160	R0.55	1.6	16°	50	4	9,280
HSB 2012-0180	R0.6	1.8	16°	50	4	5,400
HSB 2013-0190	R0.65	1.9	16°	50	4	9,280
HSB 2014-0210	R0.7	2.1	16°	50	4	5,400
HSB 2015-0150	R0.75	1.5	16°	50	4	4,680
HSB 2015-0150-6		1.5		50	6	6,000
HSB 2015-0200		2		50	4	4,680
HSB 2015-0225		2.25		50	4	4,680
HSB 2015-0400	R0.8	4	16°	50	4	4,680
HSB 2016-0240		2.4		50	4	5,400
HSB 2017-0250	R0.85	2.5	16°	50	4	9,280
HSB 2018-0270	R0.9	2.7	16°	50	4	8,000
HSB 2019-0280	R0.95	2.8	16°	50	4	9,280
HSB 2020-0200	R1	2	16°	50	4	3,480
HSB 2020-0200-6		2		60	6	4,680
HSB 2020-0300		3		50	4	3,480
HSB 2020-0600		6		60	4	3,480
HSB 2025-0250	R1.25	2.5	16°	50	4	5,950
HSB 2025-0250-6		2.5		60	6	6,360
HSB 2025-0375		3.75		50	4	5,950
HSB 2025-0600	R1.5	6	16°	60	4	5,950
HSB 2030-0300		3		50	6	4,200
HSB 2030-0450		4.5		70	6	4,200
HSB 2030-0800		8		70	6	4,200
HSB 2040-0400	R2	4	16°	50	6	4,800
HSB 2040-0600-4		6	—	70	4	4,300
HSB 2040-0600		6	16°	70	6	4,800
HSB 2040-0800		8		70	6	4,800
HSB 2050-0500	R2.5	5	16°	50	6	5,710
HSB 2050-0750		7.5		80	6	5,760
HSB 2050-0800		8		80	6	5,760
HSB 2050-1200		12		80	6	5,760
HSB 2060-0600	R3	6	—	50	6	5,940
HSB 2060-0900		9		80	6	6,000
HSB 2060-1200		12		80	6	6,000
HSB 2080-0800	R4	8	—	60	8	9,270
HSB 2080-1200		12		90	8	9,360
HSB 2080-1400		14		90	8	9,360
HSB 2100-1000	R5	10	—	70	10	12,110
HSB 2100-1500		15		100	10	12,240
HSB 2100-1800		18		100	10	12,240
HSB 2120-1200	R6	12	—	75	12	20,580
HSB 2120-1800		18		110	12	20,790
HSB 2120-2200		22		110	12	20,790

3mm Shank
V Series

UDC-PCD
Series

CBN
Series

Square

Long Neck
Square

Radius

Radius

Long Neck
Radius

Taper Neck
Radius

Ball

Ball / Long
Shank Ball

Long Neck
Ball

Taper Neck
Ball

Taper

Taper

Barrel

Barrel

Spiral
V Cutter

Spiral
V Cutter

Drill

Drill

Technical Data

Technical Data

Milling Conditions for HSB / HSB-S

WORK MATERIAL			PREHARDENED STEELS HARDENED STEELS NAK / STAVAX (~55HRC)				HARDENED STEELS SKD11 (55~62HRC)				HARDENED STEELS HAP10 (62~66HRC)				HARDENED STEELS HAP72 (66~70HRC)			
Model Number	Radius of Ball Nose (mm)	Length of Cut (mm)	Spindle Speed (min ⁻¹)	Feed Rate (mm/min)	a _p Axial Depth (mm)	a _e Radial Depth (mm)	Spindle Speed (min ⁻¹)	Feed Rate (mm/min)	a _p Axial Depth (mm)	a _e Radial Depth (mm)	Spindle Speed (min ⁻¹)	Feed Rate (mm/min)	a _p Axial Depth (mm)	a _e Radial Depth (mm)	Spindle Speed (min ⁻¹)	Feed Rate (mm/min)	a _p Axial Depth (mm)	a _e Radial Depth (mm)
20006-0006	R0.03	0.06	30,000	100	0.002 or below	0.02	—	—	—	—	—	—	—	—	—	—	—	—
20008-0008	R0.04	0.08	30,000	130	0.003 or below	0.03	—	—	—	—	—	—	—	—	—	—	—	—
1001-0020-6	R0.05	0.2	30,000	30	0.002 or below	0.02	—	—	—	—	—	—	—	—	—	—	—	—
2001-0010		0.1	30,000	200	0.004 or below	0.04	—	—	—	—	—	—	—	—	—	—	—	—
2002-0020 (-6)	R0.1	0.2	60,000	200	0.003	0.005	60,000	200	0.002	0.003	60,000	130	0.002	0.003	45,000	65	0.002	0.003
2002-0030		0.3	60,000	200	0.003	0.005	60,000	200	0.002	0.003	60,000	130	0.002	0.003	45,000	65	0.002	0.003
2003-0030 (-6)	R0.15	0.3	60,000	350	0.006	0.008	45,000	310	0.004	0.007	43,500	180	0.003	0.005	32,500	90	0.003	0.005
2003-0045		0.45	60,000	350	0.006	0.008	45,000	310	0.004	0.007	43,500	180	0.003	0.005	32,500	90	0.003	0.005
2004-0040 (-6)	R0.2	0.4	50,000	500	0.01	0.02	37,500	420	0.007	0.012	35,000	240	0.005	0.008	26,250	120	0.005	0.008
2004-0060		0.6	50,000	500	0.01	0.02	37,500	420	0.007	0.012	35,000	240	0.005	0.008	26,250	120	0.005	0.008
2005-0050 (-6)	R0.25	0.5	44,000	650	0.015	0.04	33,000	530	0.01	0.02	30,000	300	0.007	0.01	22,500	150	0.007	0.01
2005-0075		0.75	44,000	650	0.015	0.04	33,000	530	0.01	0.02	30,000	300	0.007	0.01	22,500	150	0.007	0.01
2006-0060 (-6)	R0.3	0.6	40,000	1,100	0.03	0.13	30,000	1,200	0.02	0.1	26,500	800	0.01	0.075	20,000	400	0.01	0.075
2006-0090		0.9	40,000	1,100	0.03	0.13	30,000	1,200	0.02	0.1	26,500	800	0.01	0.075	20,000	400	0.01	0.075
2007-0100	R0.35	1	37,000	1,350	0.045	0.17	28,500	1,400	0.03	0.135	25,000	900	0.015	0.1	18,750	450	0.015	0.1
2008-0080 (-6)	R0.4	0.8	35,000	1,600	0.06	0.21	27,000	1,600	0.04	0.17	23,500	1,000	0.02	0.12	17,500	500	0.02	0.12
2008-0120		1.2	35,000	1,600	0.06	0.21	27,000	1,600	0.04	0.17	23,500	1,000	0.02	0.12	17,500	500	0.02	0.12
2009-0130	R0.45	1.3	32,500	1,650	0.1	0.28	25,500	1,800	0.055	0.21	22,000	1,300	0.025	0.14	16,500	650	0.025	0.14
2010-0100 (-6)	R0.5	1	30,000	1,750	0.2	0.4	24,000	2,000	0.1	0.3	21,000	1,750	0.05	0.2	16,000	875	0.05	0.2
2010-0150		1.5	30,000	1,750	0.2	0.4	24,000	2,000	0.1	0.3	21,000	1,750	0.05	0.2	16,000	875	0.05	0.2
2010-0250		2.5	30,000	1,750	0.1	0.3	24,000	2,000	0.05	0.2	21,000	1,750	0.03	0.17	16,000	875	0.03	0.17
2011-0160	R0.55	1.6	30,000	1,900	0.21	0.43	22,000	2,000	0.105	0.32	19,000	1,750	0.05	0.22	14,250	875	0.05	0.22
2012-0180	R0.6	1.8	30,000	2,000	0.22	0.46	20,500	2,000	0.11	0.34	17,800	1,750	0.05	0.23	13,350	875	0.05	0.23
2013-0190	R0.65	1.9	30,000	2,150	0.23	0.49	19,000	2,000	0.115	0.36	16,600	1,750	0.05	0.24	12,450	875	0.05	0.24
2014-0210	R0.7	2.1	30,000	2,300	0.24	0.52	18,000	2,000	0.12	0.39	15,700	1,750	0.055	0.27	11,800	875	0.055	0.27
2015-0150 (-6)	R0.75	1.5	30,000	2,450	0.25	0.55	17,000	2,000	0.12	0.4	15,000	1,750	0.06	0.29	11,250	875	0.06	0.29
2015-0200		2	30,000	2,450	0.25	0.55	17,000	2,000	0.12	0.4	15,000	1,750	0.06	0.29	11,250	875	0.06	0.29
2015-0225		2.25	30,000	2,450	0.25	0.55	17,000	2,000	0.12	0.4	15,000	1,750	0.06	0.29	11,250	875	0.06	0.29
2015-0400		4	30,000	2,450	0.15	0.45	17,000	2,000	0.07	0.31	15,000	1,750	0.04	0.24	11,250	875	0.04	0.24
2016-0240	R0.8	2.4	30,000	2,550	0.25	0.58	16,200	2,000	0.13	0.43	14,200	1,750	0.06	0.3	10,650	875	0.06	0.3
2017-0250	R0.85	2.5	30,000	2,600	0.26	0.61	15,500	2,000	0.135	0.46	13,500	1,750	0.065	0.32	10,100	875	0.065	0.32
2018-0270	R0.9	2.7	30,000	2,700	0.28	0.65	15,000	2,000	0.14	0.48	13,000	1,750	0.07	0.34	9,750	875	0.07	0.34
2019-0280	R0.95	2.8	29,000	2,800	0.3	0.69	14,500	2,000	0.145	0.49	12,600	1,750	0.075	0.36	9,450	875	0.075	0.36
2020-0200 (-6)	R1	2	28,000	2,900	0.3	0.7	14,000	2,100	0.15	0.5	12,250	1,800	0.08	0.35	9,200	900	0.08	0.35
2020-0300		3	28,000	2,900	0.3	0.7	14,000	2,100	0.15	0.5	12,250	1,800	0.08	0.35	9,200	900	0.08	0.35
2020-0600		6	28,000	2,900	0.2	0.6	14,000	2,100	0.1	0.4	12,250	1,800	0.06	0.3	9,200	900	0.06	0.3
2025-0250 (-6)	R1.25	2.5	24,500	2,950	0.35	0.85	12,250	2,150	0.17	0.6	10,700	1,850	0.1	0.45	8,050	925	0.1	0.45
2025-0375		3.75	24,500	2,950	0.35	0.85	12,250	2,150	0.17	0.6	10,700	1,850	0.1	0.45	8,050	925	0.1	0.45
2025-0600	6	24,500	2,950	0.26	0.75	12,250	2,150	0.125	0.5	10,700	1,850	0.08	0.4	8,050	925	0.08	0.4	
2030-0300	R1.5	3	21,000	3,000	0.4	1	10,500	2,200	0.2	0.7	9,200	1,900	0.12	0.55	6,900	950	0.12	0.55
2030-0450		4.5	21,000	3,000	0.4	1	10,500	2,200	0.2	0.7	9,200	1,900	0.12	0.55	6,900	950	0.12	0.55
2030-0800		8	21,000	3,000	0.3	0.9	10,500	2,200	0.15	0.65	9,200	1,900	0.1	0.5	6,900	950	0.1	0.5
2040-0400	R2	4	18,000	3,200	0.5	1.3	9,000	2,300	0.25	0.95	7,900	2,000	0.15	0.75	5,900	1,000	0.15	0.75
2040-0600 (-4)		6	18,000	3,200	0.5	1.3	9,000	2,300	0.25	0.95	7,900	2,000	0.15	0.75	5,900	1,000	0.15	0.75
2040-0800		8	18,000	3,200	0.5	1.3	9,000	2,300	0.25	0.95	7,900	2,000	0.15	0.75	5,900	1,000	0.15	0.75
2050-0500	R2.5	5	15,600	3,500	0.5	1.5	7,800	2,500	0.25	1.05	6,800	2,100	0.15	0.85	5,100	1,050	0.15	0.85
2050-0750		7.5	15,600	3,500	0.5	1.5	7,800	2,500	0.25	1.05	6,800	2,100	0.15	0.85	5,100	1,050	0.15	0.85
2050-0800		8	15,600	3,500	0.5	1.5	7,800	2,500	0.25	1.05	6,800	2,100	0.15	0.85	5,100	1,050	0.15	0.85
2050-1200		12	15,600	3,500	0.5	1.5	7,800	2,500	0.25	1.05	6,800	2,100	0.15	0.85	5,100	1,050	0.15	0.85

- φ3mm Shank V Series
- UDC-PCD Series
- CBN Series
- Square
- Long Neck Square
- Radius
- Long Neck Radius
- Taper Neck Radius
- Ball / Long Shank Ball
- Long Neck Ball
- Taper Neck Ball
- Taper
- Barrel
- Spiral V Cutter
- Drill
- Technical Data

Milling Conditions for HSB / HSB-S

WORK MATERIAL			PREHARDENED STEELS HARDENED STEELS NAK / STAVAX (~55HRC)				HARDENED STEELS SKD11 (55~62HRC)				HARDENED STEELS HAP10 (62~66HRC)				HARDENED STEELS HAP72 (66~70HRC)			
Model Number	Radius of Ball Nose (mm)	Length of Cut (mm)	Spindle Speed (min ⁻¹)	Feed Rate (mm/min)	a_p Axial Depth (mm)	a_e Radial Depth (mm)	Spindle Speed (min ⁻¹)	Feed Rate (mm/min)	a_p Axial Depth (mm)	a_e Radial Depth (mm)	Spindle Speed (min ⁻¹)	Feed Rate (mm/min)	a_p Axial Depth (mm)	a_e Radial Depth (mm)	Spindle Speed (min ⁻¹)	Feed Rate (mm/min)	a_p Axial Depth (mm)	a_e Radial Depth (mm)
2060-0600	R3	6	13,000	3,500	0.6	1.8	6,500	2,500	0.3	1.3	5,700	2,200	0.2	1	4,300	1,100	0.2	1
2060-0900		9	13,000	3,500	0.6	1.8	6,500	2,500	0.3	1.3	5,700	2,200	0.2	1	4,300	1,100	0.2	1
2060-1200		12	13,000	3,500	0.6	1.8	6,500	2,500	0.3	1.3	5,700	2,200	0.2	1	4,300	1,100	0.2	1
2080-0800	R4	8	9,500	3,000	0.7	2.1	5,200	2,200	0.4	1.7	4,500	1,900	0.25	1.35	3,400	950	0.25	1.35
2080-1200		12	9,500	3,000	0.7	2.1	5,200	2,200	0.4	1.7	4,500	1,900	0.25	1.35	3,400	950	0.25	1.35
2080-1400		14	9,500	3,000	0.7	2.1	5,200	2,200	0.4	1.7	4,500	1,900	0.25	1.35	3,400	950	0.25	1.35
2100-1000	R5	10	7,500	2,500	0.8	2.5	4,300	2,000	0.5	2.1	3,750	1,750	0.3	1.7	2,800	875	0.3	1.7
2100-1500		15	7,500	2,500	0.8	2.5	4,300	2,000	0.5	2.1	3,750	1,750	0.3	1.7	2,800	875	0.3	1.7
2100-1800		18	7,500	2,500	0.8	2.5	4,300	2,000	0.5	2.1	3,750	1,750	0.3	1.7	2,800	875	0.3	1.7
2120-1200	R6	12	6,200	2,000	0.9	3	3,600	1,750	0.6	2.6	3,150	1,500	0.35	2	2,350	750	0.35	2
2120-1800		18	6,200	2,000	0.9	3	3,600	1,750	0.6	2.6	3,150	1,500	0.35	2	2,350	750	0.35	2
2120-2200		22	6,200	2,000	0.9	3	3,600	1,750	0.6	2.6	3,150	1,500	0.35	2	2,350	750	0.35	2

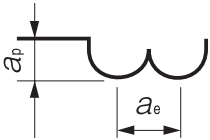

Note:

- Decrease the feed rate more than 50% from the milling parameters when slot milling.
- Decrease both spindle speed and feed rate proportionally when the milling parameters exceed the machines maximum speed, or when the tool is chattering and heats up to a red color.
- Reduce the milling parameters when a straight shank tool exceeds 35 mm of overhang length.
- Every coolant offers stable milling.

Constant Velocity Joint

DRM2 (62HRC)

Work Size $\phi 100 \times 50$ mm

Coolant Oil Mist

6 Flute Square for Hard Materials **HMS**2 Flute Ball for Hard Materials **HSB**

Milling Process	Tool	Milling Spot	Spindle Speed (min ⁻¹)	Feed Rate (mm/min)	a_p (mm)	a_e (mm)	Allowance (mm)	Cycle Time (h:m:s)
Roughing	HSB R5	Pilot Hole	600	240	1	—	—	4:52
	HMS $\phi 10$ 6 Flute Square	Dimension	4,000	200	16	0.1	—	3:49
2,500				16	0.2	0.02	2:12	
Finishing	HSB R5	Contour	3,150	200	0.05	7	0	1:24
Roughing				800	0.5	2	0.2	24:36
Semi-finishing	HSB R2	Contour	15,000	1,400	0.25	0.7	0.07	15:18
	HSB R1	Contour	18,000	1,800	0.15	0.15	0.02	21:58
Finishing	HSB R1	Dimension	20,000	1,000	0.05	—	0	0:51
	CBN R1	Contour	20,000	1,800	0.07	0.04	0	71:19

2:26:12

3mm Shank
V SeriesUDC-PCD
SeriesCBN
Series

Square

Long Neck
Square

Radius

Long Neck
RadiusTaper Neck
RadiusBall / Long
Shank BallLong Neck
BallTaper Neck
Ball

Taper

Barrel

Spiral
V Cutter

Drill

Technical Data



Size R0.1~R2

Short Shank Series

HSB-S



Material Applications (★ Highly Recommended ● Recommended ○ Suggested)

Work Material																	
Carbon Steels S45C S55C	Alloy Steels SK / SCM SUS	Prehardened Steels NAK HPM	Hardened Steels					Cast Iron	Aluminum Alloys	Graphite	Copper	Plastics	Glass Filled Plastics	Titanium Alloys	Heat Resistant Alloys	Cemented Carbide	Hard Brittle (Non-Metallic) Materials
			~50HRC	~55HRC	~60HRC	~65HRC	~70HRC										
○	○	●	●	●	●	○	○			○			○	○			

Features

Short Shank Ball End Mills for high accuracy shrink-fit tool holder.

Offers high efficiency, long tool life and excellent surface finish on hard materials over 40HRC.

HARDMAX coat offers heat resistance, durability and lubricity at a high level.

Every coolant offers stable milling.

Ball tip point is designed with a negative rake angle that minimizes wear and improves the target dimensions.

The low negative rake angle at the peripheral side of the ball offers an excellent surface finish and prevents deflection.

Better Tolerance Design! Diameter Tolerance, Ball Radius Accuracy, and Shank Diameter Tolerance

HSB / HSLB Tolerance

Radius of Ball Nose	Diameter Tolerance	Ball Radius Accuracy	Shank Diameter Tolerance
R0.1 ~ R3	0/-0.015	±0.005	0/-0.005 (h5)

HSB-S / HSLB-S Tolerance

Radius of Ball Nose	Diameter Tolerance	Ball Radius Accuracy	Shank Diameter Tolerance
R0.1 ~ R1	0/-0.008	±0.003	0/-0.004 (h4)
R1.5 ~ R2	0/-0.01		
R3		±0.005	

Shank diameter tolerance h4!

Short overhang length with short shank length!

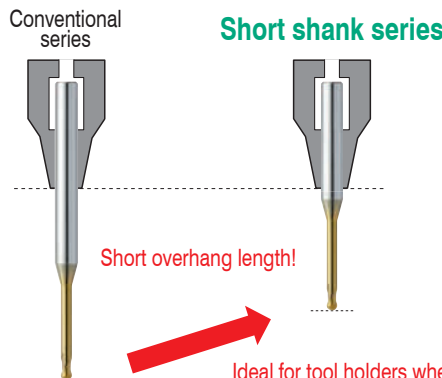

Short overhang length minimizes tool run-out

High precision milling

Minimizes vibration and chattering

Longer tool life

Ideal for tool holders where the maximum insertion is short.

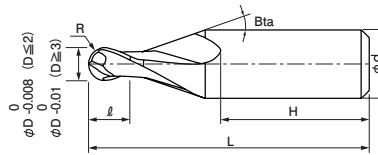
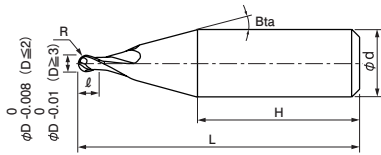

The shank taper angle and the shank length (H) shown are not an exact value and to avoid contact with the work piece, we recommend the user controls the precise value of this angle. Shank taper angle should not make contact with the work piece.

Total 10 models

Unit (mm)

Model Number	Radius of Ball Nose R	Length of Cut ℓ	Shank Taper Angle B_{ta}	Overall Length L	Shank Diameter ϕd	Shank Length H	Suggested Retail Price ¥
HSB 2002-0020S	RO.1	0.2	16°	35	4	26.0	8,520
HSB 2003-0030S	RO.15	0.3	16°	35	4	26.0	6,960
HSB 2004-0040S	RO.2	0.4	16°	35	4	26.0	4,680
HSB 2006-0060S	RO.3	0.6	16°	35	4	26.0	4,200
HSB 2008-0080S	RO.4	0.8	16°	35	4	26.5	4,200
HSB 2010-0100S	RO.5	1	16°	35	4	26.5	3,840
HSB 2015-0150S	RO.75	1.5	16°	35	4	26.5	4,680
HSB 2020-0200S	R1	2	16°	35	4	25.5	3,480
HSB 2030-0300S	R1.5	3	16°	40	6	27.0	4,200
HSB 2040-0400S	R2	4	16°	40	6	26.0	4,800

Press Die

DC53 (60HRC)



Work Size 100 × 120 × 50 mm
Coolant Oil Mist

Tool used mainly

HSB

HSLB



Milling Process	Tool		Spindle Speed (min ⁻¹)	Feed Rate (mm/min)	a_p (mm)	a_e (mm)	Cycle Time (h:m:s)	Milling Distance (m)
Roughing	HSB 2 Flute Ball	R4	5,200	2,200	0.4	1.7	2:52:35	334
Roughing	HSLB 2 Flute Long Neck Ball	R3 × EL30	6,500	2,500	0.2	0.65	0:28:01	46
Semi-finishing		R2 × EL25	8,000	1,160	0.7 (Ridgeline)	0.35 (Orthogonal)	0:21:38	18
Semi-finishing		R3 × EL30	6,500	2,500	0	0.3	0:21:38	48
Finishing		R3 × EL30	6,500	2,500	0	0.01	2:53:09	274
Finishing	HLRS 4 Flute Long Neck Radius	$\phi 6 \times \text{EL30} \times \text{CR1}$	2,200	580	0.1	1	1:03:01	23
Drilling	HSB 2 Flute Ball	R0.3	30,000	1,200	0.05	0	0:02:09	1.6

8:02:11

748

3mm Shank V Series

UDC-PCD Series

CBN Series

Square

Long Neck Square

Radius

Long Neck Radius

Taper Neck Radius

Ball / Long Shank Ball

Long Neck Ball

Taper Neck Ball

Taper

Barrel

Spiral V Cutter

Drill

Technical Data



Size R1.5~R6

HBL



Material Applications (★ Highly Recommended ● Recommended ○ Suggested)

Work Material																	
Carbon Steels S45C S55C	Alloy Steels SK / SCM SUS	Prehardened Steels NAK HPM	Hardened Steels					Cast Iron	Aluminum Alloys	Graphite	Copper	Plastics	Glass Filled Plastics	Titanium Alloys	Heat Resistant Alloys	Cemented Carbide	Hard Brittle (Non-Metallic) Materials
			~50HRC	~55HRC	~60HRC	~65HRC	~70HRC										
○	○	●	●	●	○		○			●			○	○			

Features

Long shank ball design for hard materials.
HARDMAX coating for high speed milling for Hard Materials.
 Both dry and wet coolant offer stable and long tool life.
 Diameter Tolerance: 0/-0.015 (D≤6), 0/-0.02 (D≥8)

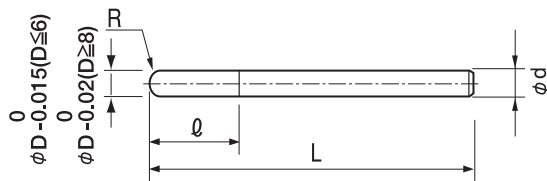

Shank part should not make contact with the work piece.

Total 6 models

Unit (mm)

Model Number	Radius of Ball Nose R	Length of Cut ℓ	Overall Length L	Shank Diameter φd	Suggested Retail Price ¥
HBL 2030-0800	R1.5	4.5	80	3	12,200
HBL 2040-1000	R2	6	100	4	13,900
HBL 2060-1400	R3	18	140	6	21,100
HBL 2080-1600	R4	20	160	8	29,480
HBL 2100-1800	R5	25	180	10	35,700
HBL 2120-2000	R6	25	200	12	46,090

Milling Conditions for HBL

WORK MATERIAL		CARBON STEELS S45C / S50C (~225HB)				ALLOY STEELS SK / SCM / SUS (225~325HB)				PREHARDENED STEELS HARDENED STEELS NAK / SKD (30~45HRC)			
Model Number	Radius of Ball Nose (mm)	Spindle Speed (min ⁻¹)	Feed Rate (mm/min)	a_p Axial Depth (mm)	a_e Radial Depth (mm)	Spindle Speed (min ⁻¹)	Feed Rate (mm/min)	a_p Axial Depth (mm)	a_e Radial Depth (mm)	Spindle Speed (min ⁻¹)	Feed Rate (mm/min)	a_p Axial Depth (mm)	a_e Radial Depth (mm)
2030-0800	R1.5	16,000	800	0.12	0.3	13,300	580	0.12	0.3	10,700	420	0.12	0.3
2040-1000	R2	12,000	840	0.16	0.4	10,000	560	0.16	0.4	8,000	400	0.16	0.4
2060-1400	R3	8,000	960	0.24	0.6	6,700	670	0.24	0.6	5,400	480	0.24	0.6
2080-1600	R4	6,000	1,050	0.32	0.8	5,000	700	0.32	0.8	4,000	520	0.32	0.8
2100-1800	R5	4,800	1,100	0.4	1	4,000	730	0.4	1	3,200	540	0.4	1
2120-2000	R6	4,000	1,130	0.48	1.2	3,400	810	0.48	1.2	2,700	590	0.48	1.2

WORK MATERIAL		HARDENED STEELS SKD61 / SKT (45~50HRC)				HARDENED STEELS SKD61 / 11 (50~60HRC)			
Model Number	Radius of Ball Nose (mm)	Spindle Speed (min ⁻¹)	Feed Rate (mm/min)	a_p Axial Depth (mm)	a_e Radial Depth (mm)	Spindle Speed (min ⁻¹)	Feed Rate (mm/min)	a_p Axial Depth (mm)	a_e Radial Depth (mm)
2030-0800	R1.5	6,400	230	0.12	0.3	4,800	90	0.12	0.3
2040-1000	R2	4,800	230	0.16	0.4	3,600	100	0.16	0.4
2060-1400	R3	3,200	250	0.24	0.6	2,400	110	0.24	0.6
2080-1600	R4	2,400	260	0.32	0.8	1,800	110	0.32	0.8
2100-1800	R5	2,000	300	0.4	1	1,500	120	0.4	1
2120-2000	R6	1,600	320	0.48	1.2	1,200	140	0.48	1.2

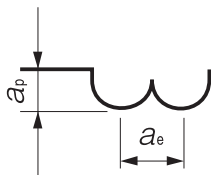

Cutting Amount (mm)
 $a_p = 0.04D$ (Max 0.5 mm)
 $a_e = 0.1D$
 D : Outside Diameter (mm)

Note:

- Decrease both spindle speed and feed rate proportionally in case of chattering.
- Set spindle speed, feed rate, and radial depth in accordance with the required surface quality.
- Adjust milling parameters according to the operating environment when milling a work piece over 60HRC.
- Recommend air blow or oil mist.
- Recommend oil coolant for Stainless Steels and Heat Resistant Alloys.
- Recommend wet coolant for Copper.

Ø3mm Shank
V Series

UDC-PCD
Series

CBN
Series

Square

Long Neck
Square

Radius

Long Neck
Radius

Taper Neck
Radius

Ball / Long
Shank Ball

Long Neck
Ball

Taper Neck
Ball

Taper

Barrel

Spiral
V Cutter

Drill

Technical Data



Size R0.05~R6

CSEB

Super
MG

UT
COAT

Shank Dia
0/-0.005

Material Applications (★ Highly Recommended ● Recommended ○ Suggested)

Work Material																	
Carbon Steels S45C S55C	Alloy Steels SK / SCM SUS	Prehardened Steels NAK HPM	Hardened Steels					Cast Iron	Aluminum Alloys	Graphite	Copper	Plastics	Glass Filled Plastics	Titanium Alloys	Heat Resistant Alloys	Cemented Carbide	Hard Brittle (Non-Metallic) Materials
			~50HRC	~55HRC	~60HRC	~65HRC	~70HRC										
●	●	●	●	●				○	●		●			○	○		

Features

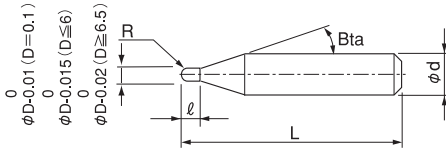

The shank taper angle shown is not an exact value and to avoid contact with the work piece, we recommend the user controls the precise value of this angle. Shank taper angle should not make contact with the work piece.

ATTENTION

CSEB 1001-0020-6 is a taper ball end mill with half included angle 10° (See the right drawing).

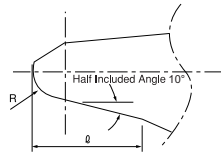

Radius of Ball Nose	Diameter Tolerance	Radius Accuracy	Helix Angle	Number of Flutes
R0.05	0/-0.01	±0.002	0°	2 Flutes *
R0.1 ~ R3	0/-0.015	±0.005	30°	
R3.25 ~ R6	0/-0.02	±0.007	30°	

* Only CSEB 1001-0020-6 has single flute.
R accuracy and diameter tolerance is the same as R0.1.

3 Features of CSEB

Reduce cutting resistance and designed to require surface quality.

Recommended for milling on hardened steels (55HRC) - sticky materials, materials that prone to chatter marks.

Less resistance on curved surface shape

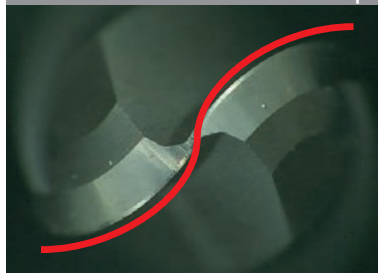

Small relief surface



Tip design with excellent cutting performance



Total 78 models

Unit (mm)

Model Number	Radius of Ball Nose R	Length of Cut ϱ	Shank Taper Angle B β	Overall Length L	Shank Diameter ϕd	Suggested Retail Price ¥
CSEB 1001-0020-6	RO.05	0.2	11°	50	6	13,320
CSEB 2001-0010	RO.05	0.1	11°	50	4	12,120
CSEB 2002-0020-6	RO.1	0.2	11°	50	6	9,840
CSEB 2002-0030		0.3		50	4	8,520
CSEB 2003-0030	RO.15	0.3	11°	50	4	6,960
CSEB 2003-0030-6		0.3		50	6	8,400
CSEB 2003-0045		0.45		50	4	6,960
CSEB 2004-0040	RO.2	0.4	11°	50	4	4,680
CSEB 2004-0040-6		0.4		50	6	6,120
CSEB 2004-0060		0.6		50	4	4,680
CSEB 2005-0050	RO.25	0.5	11°	50	4	4,320
CSEB 2005-0050-6		0.5		50	6	5,760
CSEB 2005-0075		0.75		50	4	4,320
CSEB 2006-0060	RO.3	0.6	11°	50	4	4,200
CSEB 2006-0060-6		0.6		50	6	5,520
CSEB 2006-0090		0.9		50	4	4,200
CSEB 2007-0100	RO.35	1	11°	50	4	8,000
CSEB 2008-0080	RO.4	0.8	11°	50	4	4,200
CSEB 2008-0080-6		0.8		50	6	5,520
CSEB 2008-0120	RO.45	1.2	11°	50	4	4,200
CSEB 2009-0130		1.3		50	4	8,000
CSEB 2010-0100	RO.5	1	11°	50	4	3,840
CSEB 2010-0100-6		1		50	6	5,160
CSEB 2010-0150		1.5		50	4	3,840
CSEB 2010-0250		2.5		50	4	3,840
CSEB 2011-0160	RO.55	1.6	11°	50	4	9,280
CSEB 2012-0180	RO.6	1.8	11°	50	4	5,400
CSEB 2013-0190	RO.65	1.9	11°	50	4	9,280
CSEB 2014-0210	RO.7	2.1	11°	50	4	5,400
CSEB 2015-0150	RO.75	1.5	11°	50	4	4,680
CSEB 2015-0150-6		1.5		50	6	6,000
CSEB 2015-0200		2		50	4	4,680
CSEB 2015-0225		2.25		50	4	4,680
CSEB 2015-0400	RO.8	4	11°	50	4	4,680
CSEB 2016-0240		2.4		50	4	5,400
CSEB 2017-0250	RO.85	2.5	11°	50	4	9,280
CSEB 2018-0270	RO.9	2.7	11°	50	4	8,000
CSEB 2019-0280	RO.95	2.8	11°	50	4	9,280
CSEB 2020-0200	R1	2	11°	50	4	3,480
CSEB 2020-0200-6		2		60	6	4,680
CSEB 2020-0300		3		60	4	3,480
CSEB 2020-0600		6		60	4	3,480
CSEB 2025-0250	R1.25	2.5	11°	50	4	5,950
CSEB 2025-0250-6		2.5		60	6	7,200
CSEB 2025-0375		3.75		50	4	5,950
CSEB 2025-0600	R1.5	6	11°	60	4	5,950
CSEB 2030-0300		3		50	6	4,200
CSEB 2030-0450		4.5		70	6	4,200
CSEB 2030-0800	R1.75	8	11°	70	6	4,200
CSEB 2035-0520		5.2		70	6	7,800
CSEB 2040-0400	R2	4	11°	50	6	4,800
CSEB 2040-0600-4		6	—	70	4	4,300
CSEB 2040-0600		6	11°	70	6	4,800
CSEB 2040-0800		8		70	6	4,800

3mm Shank
V SeriesUDC-PCD
SeriesCBN
SeriesSquare
Long Neck
Square

Radius

Long Neck
RadiusTaper Neck
RadiusBall / Long
Shank BallLong Neck
BallTaper Neck
Ball

Taper

Barrel

Spiral
V Cutter

Drill

Technical Data

Unit (mm)

Model Number	Radius of Ball Nose R	Length of Cut l	Shank Taper Angle B α	Overall Length L	Shank Diameter ϕd	Suggested Retail Price ¥
CSEB 2045-0670	R2.25	6.7	11°	70	6	10,610
CSEB 2050-0500	R2.5	5	11°	50	6	5,710
CSEB 2050-0750		7.5		80	6	5,760
CSEB 2050-0800		8		80	6	5,760
CSEB 2050-1200		12		80	6	5,760
CSEB 2055-0820	R2.75	8.2	11°	80	6	11,660
CSEB 2060-0600	R3	6	—	50	6	5,940
CSEB 2060-0900		9		80	6	6,000
CSEB 2060-1200		12		80	6	6,000
CSEB 2065-0970	R3.25	9.7	11°	90	8	13,200
CSEB 2070-1050	R3.5	10.5	11°	90	8	10,560
CSEB 2075-1120	R3.75	11.2	11°	90	8	13,200
CSEB 2080-0800	R4	8	—	60	8	9,270
CSEB 2080-1200		12		90	8	9,360
CSEB 2080-1400		14		90	8	9,360
CSEB 2085-1270	R4.25	12.7	11°	100	10	14,630
CSEB 2090-1350	R4.5	13.5	11°	100	10	14,630
CSEB 2100-1000	R5	10	—	70	10	12,110
CSEB 2100-1500		15		100	10	12,240
CSEB 2100-1800		18		100	10	12,240
CSEB 2110-1650	R5.5	16.5	11°	110	12	24,420
CSEB 2120-1200	R6	12	—	75	12	20,580
CSEB 2120-1800		18		110	12	20,790
CSEB 2120-2200		22		110	12	20,790

Copper Milling

C1100

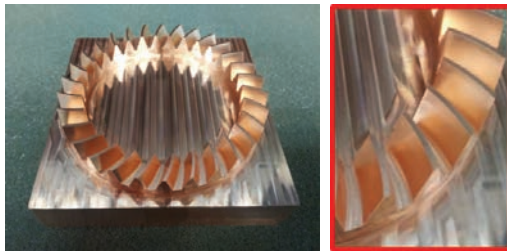

Work Size 100 × 100 × 30 mm
Coolant Oil Mist

Size R0.05~R6

CSEB



Size R0.05~R3

CSELB



Size $\phi 1 \sim \phi 20$

C-CES4000



Tool		Spindle Speed (min ⁻¹)	Feed Rate (mm/min)	a_p (mm)	a_e (mm)	Cycle Time (h:m:s)
C-CES 4 Flute Square	$\phi 6 \times L13$	12,000	3,600	0.35	4	0:52:51
CSELB 2 Flute Long Neck Ball	R1.5 × EL16	16,000	1,200	0.27	0.45	1:04:57
C-CES 4 Flute Square	$\phi 6 \times L13$	16,000	500	0.1	3.5	0:15:54
C-CES 4 Flute Square	$\phi 6 \times L13$	6,000	200 ~ 500	11	0.05	0:03:42
CSEB 2 Flute Ball	R0.5	18,000	1,800	0.3	0.3	2:34:10
C-CES 4 Flute Square	$\phi 1.5 \times L3.75$	15,000	1,200	—	0.03	0:08:14

4:59:48

Milling example of plastic mold

HPM38 (53HRC)

◆Optimized Ball Tip Effect

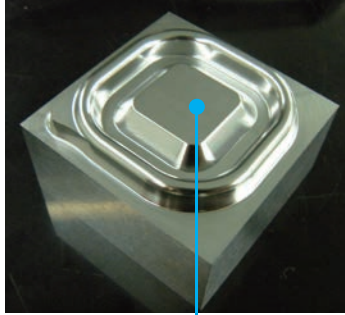

CSEB 2040-0600



CSEB 2020-0300

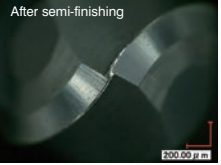

CSEB 2010-0150



Work Size
50 × 50 × 30 mm

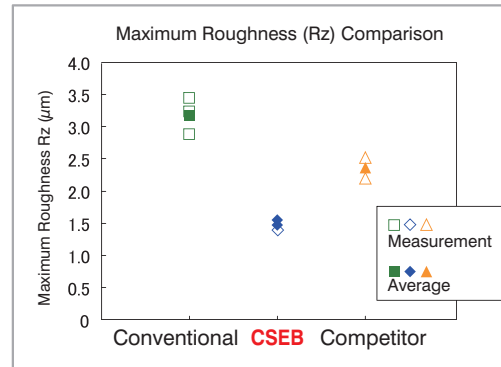
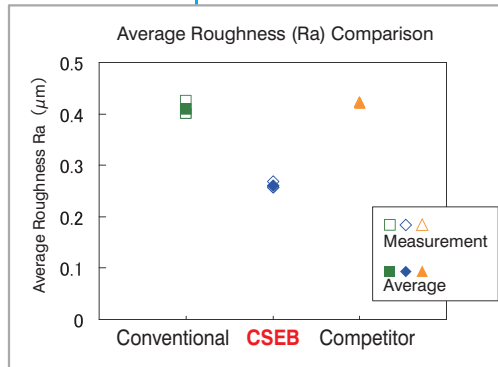

Optimized ball tip offers outstandingly nano-smooth surface on finishing.

No	Milling Process	Tool (Radius of Ball Nose × Length of Cut)	Spindle Speed (min ⁻¹)	Feed Rate (mm/min)	a_p (mm)	a_e (mm)	Overhang Length (mm)	Cycle Time (h:m:s)	Coolant
1	Roughing	CSEB 2040-0600 (R2×6)	11,000	2,000	0.34	1	15	0:31:21	Air Blow
2	Semi-finishing	CSEB 2020-0300 (R1×3)	16,000	1,300	0.17	0.5	13	0:03:10	Air Blow
3			16,000	1,300	0.1	0.1	13	0:16:47	Air Blow
4			16,000	1,300	0.01	0.1	13	0:37:00	Oil Mist
5	Finishing	CSEB 2010-0150 (R0.5×1.5)	22,000	1,300	0.04	0.18	12	0:05:06	Oil Mist
6			22,000	700	0.05	0.05	12	0:59:36	Oil Mist
7			22,000	700	0.01	0.05	12	0:30:43	Oil Mist

φ3mm Shank
V Series

UDC-PCD
Series

CBN
Series

Square
Square

Radius
Long Neck
Radius

Taper Neck
Radius

Ball / Long
Shank Ball

Long Neck
Ball

Taper Neck
Ball

Taper

Barrel

Spiral
V Cutter

Drill

Technical Data

Milling Conditions for CSEB

WORK MATERIAL			COPPER / ALUMINUM ALLOYS				CARBON STEELS / ALLOY STEELS S45C / S50C / SK / SCM (~325HB)				PREHARDENED STEELS NAK80 / STAVAX / HPM38 (30~45HRC)				HARDENED STEELS STAVAX / HPM38 / SKD61 (45~55HRC)			
Model Number	Radius of Ball Nose (mm)	Length of Cut (mm)	Spindle Speed (min ⁻¹)	Feed Rate (mm/min)	a _p Axial Depth (mm)	a _e Radial Depth (mm)	Spindle Speed (min ⁻¹)	Feed Rate (mm/min)	a _p Axial Depth (mm)	a _e Radial Depth (mm)	Spindle Speed (min ⁻¹)	Feed Rate (mm/min)	a _p Axial Depth (mm)	a _e Radial Depth (mm)	Spindle Speed (min ⁻¹)	Feed Rate (mm/min)	a _p Axial Depth (mm)	a _e Radial Depth (mm)
1001-0020-6	R0.05	0.2	30,000	30	0.002 or below	0.02	30,000	30	0.002 or below	0.02	30,000	30	0.002 or below	0.02	30,000	30	0.002 or below	0.02
2001-0010		0.1	30,000	200	0.004 or below	0.04	30,000	200	0.004 or below	0.04	30,000	200	0.004 or below	0.04	30,000	200	0.004 or below	0.04
2002-0020-6	R0.1	0.2	60,000	350	0.008	0.024	60,000	350	0.008	0.016	60,000	300	0.008	0.024	60,000	300	0.006	0.018
2002-0030		0.3	60,000	350	0.008	0.024	60,000	350	0.008	0.016	60,000	300	0.008	0.024	60,000	300	0.006	0.018
2003-0030(-6)	R0.15	0.3	43,000	500	0.012	0.036	43,000	500	0.012	0.024	54,000	450	0.012	0.036	43,000	450	0.008	0.024
2003-0045		0.45	43,000	500	0.012	0.036	43,000	500	0.012	0.024	54,000	450	0.012	0.036	43,000	450	0.008	0.024
2004-0040(-6)	R0.2	0.4	35,000	1,200	0.03	0.09	35,000	1,200	0.02	0.04	50,000	650	0.025	0.075	35,000	650	0.015	0.045
2004-0060		0.6	35,000	1,200	0.03	0.09	35,000	1,200	0.02	0.04	50,000	650	0.025	0.075	35,000	650	0.015	0.045
2005-0050(-6)	R0.25	0.5	34,000	1,300	0.035	0.105	34,000	1,300	0.03	0.06	45,000	900	0.03	0.09	32,000	900	0.02	0.06
2005-0075		0.75	34,000	1,300	0.035	0.105	34,000	1,300	0.03	0.06	45,000	900	0.03	0.09	32,000	900	0.02	0.06
2006-0060(-6)	R0.3	0.6	33,000	1,500	0.05	0.15	33,000	1,500	0.04	0.08	40,000	1,300	0.045	0.09	30,000	1,300	0.04	0.06
2006-0090		0.9	33,000	1,500	0.05	0.15	33,000	1,500	0.04	0.08	40,000	1,300	0.045	0.09	30,000	1,300	0.04	0.06
2007-0100	R0.35	1	32,000	1,800	0.07	0.21	32,000	1,600	0.05	0.1	38,000	1,600	0.06	0.12	28,000	1,600	0.05	0.075
2008-0080(-6)	R0.4	0.8	30,000	2,200	0.1	0.3	30,000	1,800	0.06	0.12	35,000	1,800	0.07	0.14	25,000	1,700	0.07	0.1
2008-0120		1.2	30,000	2,200	0.1	0.3	30,000	1,800	0.06	0.12	35,000	1,800	0.07	0.14	25,000	1,700	0.07	0.1
2009-0130	R0.45	1.3	30,000	2,100	0.11	0.33	30,000	1,600	0.07	0.14	33,000	1,700	0.08	0.16	24,000	1,600	0.08	0.12
2010-0100(-6)	R0.5	1	30,000	2,000	0.12	0.36	30,000	1,600	0.08	0.16	30,000	1,600	0.09	0.18	22,000	1,600	0.09	0.13
2010-0150		1.5	30,000	2,000	0.12	0.36	30,000	1,600	0.08	0.16	30,000	1,500	0.09	0.18	22,000	1,600	0.09	0.13
2010-0250		2.5	30,000	1,700	0.09	0.27	24,000	1,400	0.06	0.12	30,000	1,300	0.075	0.15	21,500	1,300	0.075	0.1
2011-0160	R0.55	1.6	30,000	2,000	0.12	0.36	30,000	1,600	0.08	0.16	30,000	1,600	0.09	0.18	20,000	1,600	0.09	0.13
2012-0180	R0.6	1.8	30,000	2,000	0.13	0.39	30,000	1,600	0.09	0.18	30,000	1,600	0.1	0.2	18,000	1,600	0.1	0.15
2013-0190	R0.65	1.9	30,000	2,000	0.13	0.39	30,000	1,600	0.09	0.18	30,000	1,700	0.1	0.2	18,000	1,500	0.1	0.15
2014-0210	R0.7	2.1	30,000	2,000	0.14	0.42	30,000	1,500	0.1	0.2	30,000	1,700	0.11	0.2	18,000	1,500	0.11	0.16
2015-0150(-6)	R0.75	1.5	30,000	2,000	0.15	0.45	30,000	1,600	0.12	0.24	30,000	1,700	0.12	0.24	18,000	1,500	0.12	0.18
2015-0200		2	30,000	2,000	0.15	0.45	30,000	1,600	0.12	0.24	30,000	1,700	0.12	0.24	18,000	1,500	0.12	0.18
2015-0225		2.25	30,000	2,000	0.15	0.45	30,000	1,600	0.12	0.24	30,000	1,700	0.12	0.24	18,000	1,500	0.12	0.18
2015-0400		4	30,000	1,800	0.12	0.36	23,000	1,200	0.08	0.16	30,000	1,400	0.1	0.2	15,000	1,200	0.09	0.13
2016-0240	R0.8	2.4	30,000	2,000	0.16	0.48	30,000	1,600	0.12	0.24	30,000	1,800	0.12	0.36	18,000	1,400	0.1	0.2
2017-0250	R0.85	2.5	30,000	2,000	0.17	0.51	30,000	1,700	0.14	0.28	30,000	1,800	0.14	0.42	18,000	1,400	0.12	0.24
2018-0270	R0.9	2.7	30,000	2,000	0.18	0.54	30,000	1,800	0.16	0.32	30,000	1,900	0.16	0.48	16,000	1,300	0.14	0.28
2019-0280	R0.95	2.8	30,000	2,000	0.19	0.57	30,000	1,900	0.18	0.36	30,000	1,900	0.18	0.54	16,000	1,300	0.16	0.32
2020-0200(-6)	R1	2	30,000	2,000	0.2	0.6	30,000	2,000	0.21	0.42	30,000	2,000	0.2	0.6	16,000	1,300	0.17	0.5
2020-0300		3	30,000	2,000	0.2	0.6	30,000	2,000	0.21	0.42	30,000	2,000	0.2	0.6	16,000	1,300	0.17	0.5
2020-0600		6	30,000	2,000	0.2	0.6	30,000	2,000	0.14	0.42	30,000	2,000	0.13	0.45	10,800	850	0.1	0.4

- φ3mm Shank V Series
- UDC-PCD Series
- CBN Series
- Square
- Long Neck Square
- Radius
- Long Neck Radius
- Taper Neck Radius
- Ball / Long Shank Ball
- Long Neck Ball
- Taper Neck Ball
- Taper
- Barrel
- Spiral V Cutter
- Drill
- Technical Data

Milling Conditions for CSEB

WORK MATERIAL		COPPER / ALUMINUM ALLOYS					CARBON STEELS / ALLOY STEELS S45C / S50C / SK / SCM (~325HB)				PREHARDENED STEELS NAK80 / STAVAX / HPM38 (30~45HRC)				HARDENED STEELS STAVAX / HPM38 / SKD61 (45~55HRC)			
Model Number	Radius of Ball Nose (mm)	Length of Cut (mm)	Spindle Speed (min ⁻¹)	Feed Rate (mm/min)	a _p (mm)	a _e (mm)	Spindle Speed (min ⁻¹)	Feed Rate (mm/min)	a _p (mm)	a _e (mm)	Spindle Speed (min ⁻¹)	Feed Rate (mm/min)	a _p (mm)	a _e (mm)	Spindle Speed (min ⁻¹)	Feed Rate (mm/min)	a _p (mm)	a _e (mm)
2025-0250 (-6)	R1.25	2.5	27,000	2,300	0.28	0.75	27,000	2,300	0.25	0.5	27,000	2,300	0.25	0.75	13,000	1,100	0.21	0.63
2025-0375		3.75	27,000	2,300	0.28	0.75	27,000	2,300	0.25	0.5	27,000	2,300	0.25	0.75	13,000	1,100	0.21	0.63
2025-0600	R1.5	6	25,000	2,100	0.26	0.67	25,000	2,100	0.23	0.46	24,000	2,000	0.2	0.65	11,000	930	0.14	0.44
2030-0300		3	24,000	2,500	0.32	0.9	24,000	2,500	0.32	0.9	24,000	2,500	0.3	0.9	14,000	1,400	0.25	0.76
2030-0450	R1.5	4.5	24,000	2,500	0.32	0.9	24,000	2,500	0.32	0.9	24,000	2,500	0.3	0.9	14,000	1,400	0.25	0.76
2030-0800		8	22,000	2,300	0.28	0.7	22,000	2,300	0.28	0.7	20,000	2,000	0.2	0.65	10,700	1,000	0.18	0.54
2035-0520	R1.75	5.2	24,000	2,700	0.35	1	24,000	2,700	0.35	1	21,000	2,400	0.35	1	12,000	1,700	0.3	0.9
2040-0400	R2	4	24,000	2,900	0.4	1.2	24,000	2,900	0.4	1.2	18,000	2,400	0.4	1.2	11,000	2,000	0.34	1
2040-0600 (-4)		6	24,000	2,900	0.4	1.2	24,000	2,900	0.4	1.2	18,000	2,400	0.4	1.2	11,000	2,000	0.34	1
2040-0800		8	24,000	2,900	0.4	1.2	24,000	2,900	0.4	1.2	18,000	2,400	0.4	1.2	11,000	2,000	0.34	1
2045-0670	R2.25	6.7	21,000	3,000	0.45	1.3	21,000	3,000	0.45	1.3	16,000	2,400	0.42	1.2	10,000	1,900	0.38	1.1
2050-0500	R2.5	5	18,000	3,000	0.5	1.5	18,000	3,000	0.5	1.5	13,000	2,400	0.45	1.4	9,000	1,800	0.42	1.2
2050-0750		7.5	18,000	3,000	0.5	1.5	18,000	3,000	0.5	1.5	13,000	2,400	0.45	1.4	9,000	1,800	0.42	1.2
2050-0800		8	18,000	3,000	0.5	1.5	18,000	3,000	0.5	1.5	13,000	2,400	0.45	1.4	9,000	1,800	0.42	1.2
2050-1200		12	18,000	3,000	0.5	1.5	18,000	3,000	0.5	1.5	13,000	2,400	0.45	1.4	9,000	1,800	0.42	1.2
2055-0820	R2.75	8.2	17,000	3,000	0.55	1.6	17,000	3,000	0.55	1.6	12,000	2,400	0.5	1.5	8,500	1,800	0.45	1.3
2060-0600	R3	6	16,000	3,100	0.6	1.8	16,000	3,100	0.6	1.8	11,000	2,310	0.55	1.7	7,500	1,800	0.5	1.5
2060-0900		9	16,000	3,100	0.6	1.8	16,000	3,100	0.6	1.8	11,000	2,310	0.55	1.7	7,500	1,800	0.5	1.5
2060-1200		12	16,000	3,100	0.6	1.8	16,000	3,100	0.6	1.8	11,000	2,310	0.55	1.7	7,500	1,800	0.5	1.5
2065-0970	R3.25	9.7	15,000	3,100	0.65	1.95	15,000	3,100	0.65	1.95	10,000	2,200	0.59	1.8	7,000	1,800	0.54	1.6
2070-1050	R3.5	10.5	14,000	3,200	0.7	2.1	14,000	3,200	0.7	2.1	9,000	2,100	0.63	1.9	6,500	1,800	0.57	1.7
2075-1120	R3.75	11.2	13,000	3,300	0.75	2.25	13,000	3,300	0.75	2.25	8,200	2,000	0.67	2	6,000	1,800	0.6	1.8
2080-0800	R4	8	12,000	3,300	0.8	2.4	12,000	3,300	0.8	2.4	7,400	1,900	0.72	2.2	5,700	1,800	0.65	2
2080-1200		12	12,000	3,300	0.8	2.4	12,000	3,300	0.8	2.4	7,400	1,900	0.72	2.2	5,700	1,800	0.65	2
2080-1400		14	12,000	3,300	0.8	2.4	12,000	3,300	0.8	2.4	7,400	1,900	0.72	2.2	5,700	1,800	0.65	2
2085-1270	R4.25	12.7	12,000	3,300	0.85	2.55	12,000	3,300	0.85	2.55	6,800	1,800	0.75	2.3	5,400	1,700	0.7	2.1
2090-1350	R4.5	13.5	11,000	3,400	0.9	2.7	11,000	3,400	0.9	2.7	6,300	1,700	0.8	2.4	5,100	1,600	0.75	2.2
2100-1000	R5	10	10,000	3,500	1	3	10,000	3,500	1	3	5,200	1,650	0.9	2.7	4,600	1,500	0.85	2.5
2100-1500		15	10,000	3,500	1	3	10,000	3,500	1	3	5,200	1,650	0.9	2.7	4,600	1,500	0.85	2.5
2100-1800		18	10,000	3,500	1	3	10,000	3,500	1	3	5,200	1,650	0.9	2.7	4,600	1,500	0.85	2.5
2110-1650	R5.5	16.5	9,000	3,400	1.1	3.3	9,000	3,400	1.1	3.3	4,700	1,500	1	3	4,200	1,350	0.9	2.7
2120-1200	R6	12	8,400	3,300	1.2	3.6	8,400	3,300	1.2	3.6	4,300	1,350	1.1	3.2	3,800	1,250	1	3
2120-1800		18	8,400	3,300	1.2	3.6	8,400	3,300	1.2	3.6	4,300	1,350	1.1	3.2	3,800	1,250	1	3
2120-2200		22	8,400	3,300	1.2	3.6	8,400	3,300	1.2	3.6	4,300	1,350	1.1	3.2	3,800	1,250	1	3

Note:

- Decrease the feed rate more than 50% from the milling parameters when slot milling.
- Decrease both spindle speed and feed rate proportionally when the milling parameters exceed the machines maximum speed, or when the tool is chattering and heats up to a red color.
- Recommend oil coolant for Stainless Steels and Heat Resistant Alloys.
- Recommend wet coolant for Copper.

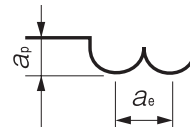
Ø3mm Shank
V SeriesUDC-PCD
SeriesCBN
Series

Square

Long Neck
Square

Radius

Long Neck
RadiusTaper Neck
RadiusBall / Long
Shank BallLong Neck
BallTaper Neck
Ball

Taper

Barrel

Spiral
V Cutter

Drill

Technical Data



Size R0.5~R6

DCB



Material Applications (★ Highly Recommended ● Recommended ○ Suggested)

Work Material																	
Carbon Steels S45C S55C	Alloy Steels SK / SCM SUS	Prehardened Steels NAK HPM	Hardened Steels					Cast Iron	Aluminum Alloys	Graphite	Copper	Plastics	Glass Filled Plastics	Titanium Alloys	Heat Resistant Alloys	Cemented Carbide	Hard Brittle (Non-Metallic) Materials
			~50HRC	~55HRC	~60HRC	~65HRC	~70HRC										
									○	★	○	○	●				○

Features

Diamond coated 2 flute ball end mills for Graphite Electrode milling.
New diamond coating with a highly adhesive base layer offers excellent wear resistance and longer tool life.

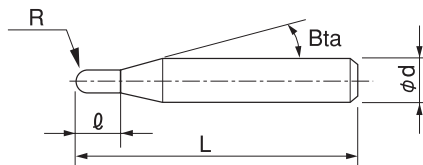

The shank taper angle shown is not an exact value and to avoid contact with the work piece, we recommend the user controls the precise value of this angle. Shank taper angle should not make contact with the work piece.

Total 9 models

Unit (mm)

Model Number	Radius of Ball Nose R	Length of Cut ℓ	Shank Taper Angle Bta	Overall Length L	Shank Diameter ϕd	Suggested Retail Price ¥
DCB 2010	R0.5	5	16°	60	4	16,000
DCB 2020	R1	10	16°	70	4	17,000
DCB 2030	R1.5	15	16°	80	4	21,000
DCB 2040	R2	20	—	100	4	24,000
DCB 2050	R2.5	20	—	100	5	28,000
DCB 2060	R3	30	—	150	6	41,500
DCB 2080	R4	40	—	150	8	45,000
DCB 2100	R5	50	—	180	10	57,500
DCB 2120	R6	55	—	180	12	87,500

Milling Conditions for DCB

WORK MATERIAL		GRAPHITE			
Model Number	Radius of Ball Nose (mm)	Spindle Speed (min ⁻¹)	Feed Rate (mm/min)	a_p Axial Depth (mm)	a_e Radial Depth (mm)
2010	R0.5	10,000	140	0.1	0.3
2020	R1	10,000	300	0.2	0.6
2030	R1.5	10,000	900	0.3	0.9
2040	R2	10,000	900	0.4	1.2
2050	R2.5	10,000	1,200	0.5	1.5
2060	R3	10,000	1,460	0.6	1.8
2080	R4	7,500	1,350	0.8	2.4
2100	R5	6,000	1,440	1	3
2120	R6	5,000	1,400	1.2	3.6

◆ High speed milling

WORK MATERIAL		GRAPHITE			
Model Number	Radius of Ball Nose (mm)	Spindle Speed (min ⁻¹)	Feed Rate (mm/min)	a_p Axial Depth (mm)	a_e Radial Depth (mm)
2010	R0.5	50,000	700	0.1	0.3
2020	R1	45,000	1,350	0.2	0.6
2030	R1.5	30,000	2,700	0.3	0.9
2040	R2	22,500	2,025	0.4	1.2
2050	R2.5	18,000	2,160	0.5	1.5
2060	R3	15,000	2,190	0.6	1.8
2080	R4	11,500	2,300	0.8	2.4
2100	R5	9,000	2,340	1	3
2120	R6	7,500	2,250	1.2	3.6

Note:

- Use a milling machine dedicated for Graphite.
- Recommend air blow for Graphite.

For 3D milling / Finishing
Milling Amount (mm)

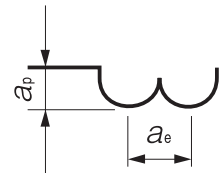

DCB Series
Aluminum:A7075
Milling Video



DCB Series
Graphite:TTK-5(80HS)
Milling Video



Ø3mm Shank
V Series

UDC-PCD
Series

CBN
Series

Square

Square

Long Neck
Square

Radius

Radius

Long Neck
Radius

Taper Neck
Radius

Ball / Long
Shank Ball

Ball

Long Neck
Ball

Taper Neck
Ball

Taper

Taper

Barrel

Spiral
V Cutter

Drill

Technical Data



Size R0.2~R6

CGB2000



Material Applications (★ Highly Recommended ● Recommended ○ Suggested)

Work Material																	
Carbon Steels S45C S55C	Alloy Steels SK / SCM SUS	Prehardened Steels NAK HPM	Hardened Steels					Cast Iron	Aluminum Alloys	Graphite	Copper	Plastics	Glass Filled Plastics	Titanium Alloys	Heat Resistant Alloys	Cemented Carbide	Hard Brittle (Non-Metallic) Materials
			~50HRC	~55HRC	~60HRC	~65HRC	~70HRC										
									○	★	○	○	○				

Features

Designed for milling Graphite.
The chosen carbide grade offers excellent resistance to wear and abrasion.
Refer to page 458 for 4 flute CGB.

The shank taper angle shown is not an exact value and to avoid contact with the work piece, we recommend the user controls the precise value of this angle. Shank taper angle should not make contact with the work piece. Actual measurement is necessary when using longer length of cut than the written length.

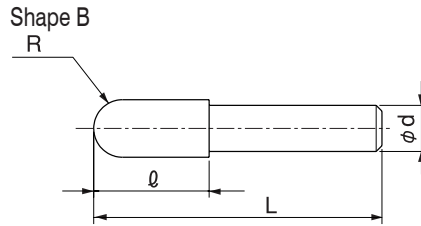
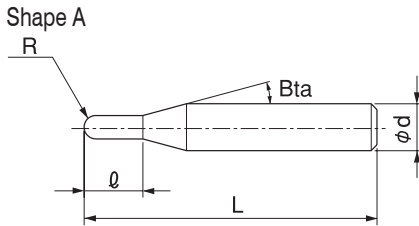

Total 15 models

Unit (mm)

Model Number	Radius of Ball Nose R	Length of Cut ℓ	Shank Taper Angle Bta	Overall Length L	Shank Diameter φd	Shape	Suggested Retail Price ¥
CGB 2004	R0.2	0.8	16°	60	4	A	11,000
CGB 2006	R0.3	1.2	16°	60	4	A	11,000
CGB 2010	R0.5	5	16°	60	4	A	11,000
CGB 2015	R0.75	5	16°	60	4	A	11,000
CGB 2020	R1	10	16°	70	4	A	12,700
CGB 2025	R1.25	10	16°	70	4	A	12,700
CGB 2030	R1.5	15	16°	80	4	A	15,600
CGB 2040	R2	20	—	100	4	A	18,600
CGB 2050	R2.5	20	—	100	5	A	18,900
CGB 2060	R3	30	—	150	6	A	21,420
CGB 2070	R3.5	30	—	150	6	B	24,050
CGB 2080	R4	40	—	150	8	A	27,170
CGB 2100	R5	50	—	180	10	A	35,420
CGB 2110	R5.5	50	—	180	10	B	38,060
CGB 2120	R6	55	—	200	12	A	41,470

Milling Conditions for CGB (2 Flutes)

WORK MATERIAL		GRAPHITE			
Model Number	Radius of Ball Nose (mm)	Spindle Speed (min ⁻¹)	Feed Rate (mm/min)	a_p Axial Depth (mm)	a_e Radial Depth (mm)
2004	R0.2	15,000	60~90	0.12	0.28
2006	R0.3	15,000	90~130	0.18	0.42
2010	R0.5	15,000	150~220	0.3	0.7
2015	R0.75	15,000	240~360	0.45	1.05
2020	R1	15,000	300~450	0.6	1.4
2025	R1.25	15,000	550~800	0.75	1.75
2030	R1.5	15,000	900~1,350	0.9	2.1
2040	R2	15,000	900~1,350	1.2	2.8
2050	R2.5	15,000	1,200~1,800	1.5	3.5
2060	R3	15,000	1,500~2,200	1.8	4.2
2070	R3.5	9,100	1,500~2,200	2.1	4.9
2080	R4	8,000	1,500~2,200	2.4	5.6
2100	R5	6,500	1,500~2,200	3	7
2110	R5.5	6,000	1,500~2,200	3.3	7.7
2120	R6	5,300	1,500~2,200	3.6	8.4

For 3D milling / Finishing
Milling Amount (mm)
 $a_p = 0.3D$
 $a_e = 0.7D$
D : Outside Diameter (mm)

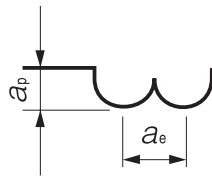

Note:
· Use a milling machine dedicated for Graphite.
· Recommend air blow for Graphite.

Graphite milling example



Work Size 150 × 150 × 150 mm
Cycle Time 2 h 18 min

CGB 2000 Non-coated ball for Graphite milling



CPRB Non-coated long neck ball for Plastic milling



Process	Milling Method	Tool		Spindle Speed (min ⁻¹)	Feed Rate (mm/min)	a_p (mm)	a_e (mm)	Allowance (mm)
Roughing	Offset	CGB	2 Flute Ball R5	6,400	6,000	2.5	4	0.3
Semi-roughing	Contour + Offset	CGB	2 Flute Ball R3	11,000	8,000	0.5	0.5	0.1
Finishing	Contour + Offset	CGB	2 Flute Ball R2	16,000	6,000	0.2	0.2	0
Finishing	Rest machining	CPRB	2 Flute Long Neck Ball R1 × EL22	30,000	4,000	0.03	0.03	0

∅3mm Shank
V Series

UDC-PCD
Series

CBN
Series

Square

Long Neck
Square

Radius

Long Neck
Radius

Taper Neck
Radius

Ball / Long
Shank Ball

Long Neck
Ball

Taper Neck
Ball

Taper

Barrel

Spiral
V Cutter

Drill

Technical Data



Size R0.3~R6

CFB

Super MG

UT COAT

30°

R ±0.005
R0.3~R1.5

R ±0.007
R2~R3

R ±0.01
R4~R6

Shank Dia 0/-0.005

Variable Pitch
R2~R6

Material Applications (★ Highly Recommended ● Recommended ○ Suggested)

Work Material																	
Carbon Steels S45C S55C	Alloy Steels SK / SCM SUS	Prehardened Steels NAK HPM	Hardened Steels					Cast Iron	Aluminum Alloys	Graphite	Copper	Plastics	Glass Filled Plastics	Titanium Alloys	Heat Resistant Alloys	Cemented Carbide	Hard Brittle (Non-Metallic) Materials
			~50HRC	~55HRC	~60HRC	~65HRC	~70HRC										
●	●	●	●	●				○	●		○		●	●			

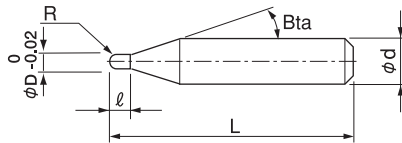

The shank taper angle shown is not an exact value and to avoid contact with the work piece, we recommend the user controls the precise value of this angle. Shank taper angle should not make contact with the work piece.

Total 14 models

Unit (mm)

Model Number	Radius of Ball Nose R	Length of Cut ℓ	Shank Taper Angle Bta	Overall Length L	Shank Diameter φd	Suggested Retail Price ¥
CFB 3006-0090	R0.3	0.9	16°	50	4	6,890
CFB 3008-0120	R0.4	1.2	16°	50	4	6,720
CFB 3010-0150	R0.5	1.5	16°	50	4	6,230
CFB 3015-0225	R0.75	2.25	16°	50	4	6,890
CFB 3020-0300	R1	3	16°	50	4	6,720
CFB 3030-0450	R1.5	4.5	16°	60	6	6,890
CFB 3040-0600-4	R2	6	—	70	4	6,560
CFB 3040-0600			16°	70	6	6,890
CFB 3050-0750	R2.5	7.5	16°	80	6	7,790
CFB 3060-0900	R3	9	—	80	6	8,610
CFB 3080-1200	R4	12	—	90	8	12,300
CFB 3080-1200LS			120	8	13,940	
CFB 3100-1500	R5	15	—	100	10	16,320
CFB 3120-1800	R6	18	—	110	12	20,660

Feature 1 High efficiency

Big pocket improves chip evacuation even with multi-flutes. Achieves **deep milling**.

Refer to P.447 Deep milling high efficiency roughing examples.

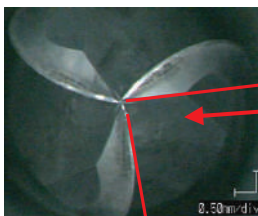

Wide angle

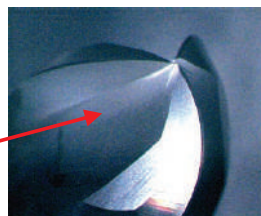

Deep tip pocket

Feature 2 Tip slot effect

Micro 3 slot design at the tip prevents chip biting even at the peripheral speed zero point, providing **an excellent surface finish**.
Micro 3 slot design is applied to R1 or above.

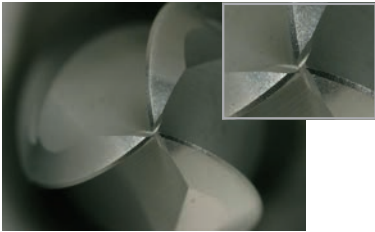

- ☆ **Radius accuracy** of the whole ball
- ± 0.005 (R1 ~ R1.5)
 - ± 0.007 (R2 ~ R3)
 - ± 0.01 (R4 ~ R6)

Comparison with 2 flutes (Ra) PXA30 30HRC

Tool Diameter R3	
Spindle Speed (min ⁻¹)	14,000
Feed Rate (mm/min)	3,900
a_p (mm)	0.1
a_e (mm)	0.24
Coolant Water soluble (Through Spindle)	

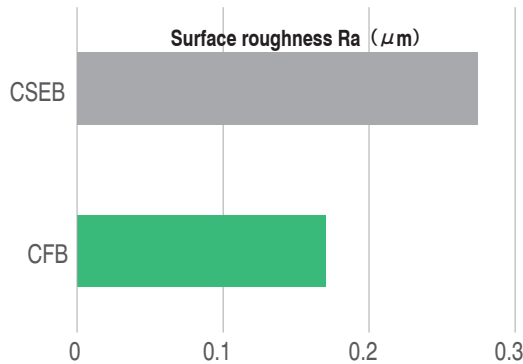

CFB enables highly efficient finishing with a wide pitch of a_e 0.24.
※ The Ra of CSEB and CFB are both the same at a_e 0.12.

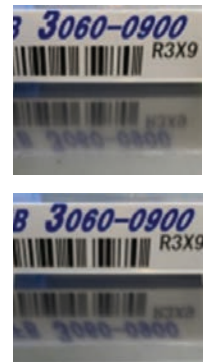

Feature 3 Designed for a wide range of materials

Suited for various heat-resistant alloys including Titanium and Inconel due to **large pocket, variable pitch and high lubricity coating**.
Tip slot design offers clean milling surfaces even for Copper, Aluminum and Acrylic.

Copper, Acrylic	
R3 Ball Finishing	
Spindle Speed (min ⁻¹)	30,000
Feed Rate (mm/min)	4,000
a_p (mm)	0.12
a_e (mm)	0.12
Coolant: Water soluble	



Copper C1100
55 × 50 × 23 mm
Excellent surface roughness even on Copper that prone to chatter marks.



Acrylic
55 × 50 × 23 mm
Even Acrylic shows this high transparency without polishing.

SUS304



Aluminum Alloys A7075



Titanium Alloys Ti-6Al-4V

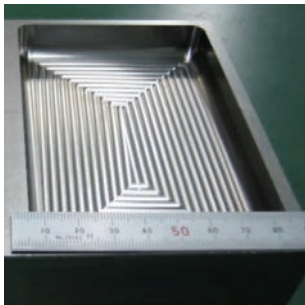

CFB R3



· Coolant: Water soluble · Pocket size 55 × 50 × 23 mm

Process	Spindle Speed (min ⁻¹)	Feed Rate (mm/min)	a _p (mm)	a _e (mm)	Cycle Time (min)
Roughing	9,000	3,000	0.6	3	9.5
Semi-finishing	9,000	3,000	0.7	0.7	4
Finishing	20,000	2,500	0.12	0.12	20.5
					34

CFB R3



· Coolant: Water soluble · Pocket size 55 × 50 × 23 mm

Process	Spindle Speed (min ⁻¹)	Feed Rate (mm/min)	a _p (mm)	a _e (mm)	Cycle Time (min)
Roughing	12,000	6,000	0.6	3	5
Semi-finishing	12,000	6,000	0.7	0.7	2
Finishing	30,000	4,000	0.12	0.12	17
					24

CFB R5



· Coolant: Water soluble · Pocket size 80 × 120 × 15 mm

Spindle Speed (min ⁻¹)	Feed Rate (mm/min)	a _p (mm)	a _e (mm)	Cycle Time (min)
3,900	2,000	1	3	25

Dramatically high feed with Titanium Alloys.

3 series of tip slot ball

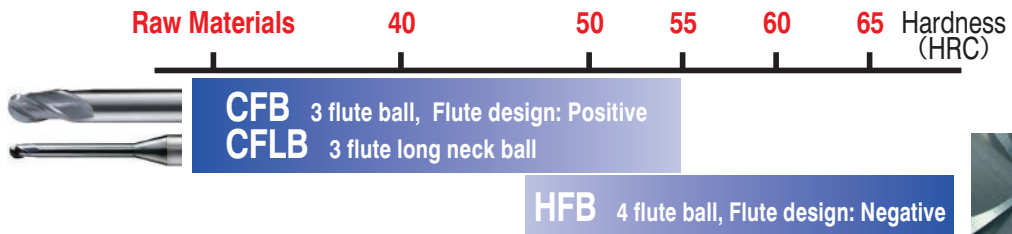

3 flute long neck ball CFLB series (P530) and 4 flute ball HFB series for hard materials (P452) are also available.



- ø3mm Shank V Series
- UDC-PCD Series
- CBN Series
- Square
- Long Neck Square
- Radius
- Long Neck Radius
- Taper Neck Radius
- Ball / Long Shank Ball
- Long Neck Ball
- Taper Neck Ball
- Taper
- Barrel
- Spiral V Cutter
- Drill
- Technical Data

Milling Conditions for CFB

◆Roughing

WORK MATERIAL		COPPER / ALUMINUM ALLOYS C1100 / A5052 / A7075 (~225HB)				ALLOY STEELS / PREHARDENED STEELS S45C / S50C / SKD / NAK (~45HRC)				HARDENED STEELS STAVAX / SKD61 (45~55HRC)			
Coolant		DRY (Unsuitable for Aluminum Alloys) / WET				DRY / WET				DRY			
Model Number	Radius of Ball Nose (mm)	Spindle Speed (min ⁻¹)	Feed Rate (mm/min)	a _p Axial Depth (mm)	a _e Radial Depth (mm)	Spindle Speed (min ⁻¹)	Feed Rate (mm/min)	a _p Axial Depth (mm)	a _e Radial Depth (mm)	Spindle Speed (min ⁻¹)	Feed Rate (mm/min)	a _p Axial Depth (mm)	a _e Radial Depth (mm)
3006-0090	R0.3	30,000	1,000	0.03	0.13	30,000	1,000	0.03	0.13	30,000	700	0.03	0.13
3008-0120	R0.4	30,000	1,250	0.04	0.17	30,000	1,250	0.04	0.17	30,000	850	0.04	0.17
3010-0150	R0.5	30,000	1,500	0.05	0.21	30,000	1,500	0.05	0.21	30,000	1,000	0.05	0.21
3015-0225	R0.75	30,000	2,500	0.075	0.32	30,000	2,500	0.075	0.32	30,000	1,700	0.075	0.32
3020-0300	R1	30,000	3,200	0.2	0.6	30,000	3,200	0.2	0.6	30,000	2,500	0.2	0.6
3030-0450	R1.5	24,000	4,000	0.3	0.9	24,000	4,000	0.3	0.9	21,600	2,700	0.3	0.9
3040-0600	R2	18,000	4,000	0.4	1.2	18,000	4,000	0.4	1.2	16,200	2,700	0.4	1.2
3050-0750	R2.5	15,000	4,000	0.5	1.5	15,000	4,000	0.5	1.5	13,500	2,700	0.5	1.5
3060-0900	R3	12,000	4,000	0.6	1.8	12,000	4,000	0.6	1.8	10,800	2,700	0.6	1.8
3080-1200 (LS)	R4	9,000	4,000	0.8	2.4	9,000	4,000	0.8	2.4	8,100	2,700	0.75	2.1
3100-1500	R5	7,200	4,000	1	3	7,200	4,000	1	3	6,500	2,700	0.85	2.5
3120-1800	R6	6,000	4,000	1.2	3.6	6,000	4,000	1.2	3.6	5,400	2,700	0.95	3

WORK MATERIAL		TITANIUM ALLOYS / STAINLESS STEELS Ti-6Al-4V / SUS				HEAT RESISTANT ALLOYS Inconel718			
Coolant		DRY (Unsuitable for Aluminum Alloys) / WET				WET			
Model Number	Radius of Ball Nose (mm)	Spindle Speed (min ⁻¹)	Feed Rate (mm/min)	a _p Axial Depth (mm)	a _e Radial Depth (mm)	Spindle Speed (min ⁻¹)	Feed Rate (mm/min)	a _p Axial Depth (mm)	a _e Radial Depth (mm)
3006-0090	R0.3	20,000	1,000	0.015	0.09	10,000	250	0.015	0.09
3008-0120	R0.4	20,000	1,250	0.02	0.12	10,000	310	0.02	0.12
3010-0150	R0.5	20,000	1,500	0.025	0.15	10,000	375	0.025	0.15
3015-0225	R0.75	20,000	2,500	0.035	0.22	10,000	625	0.035	0.22
3020-0300	R1	24,000	4,000	0.1	0.4	12,000	1,000	0.1	0.4
3030-0450	R1.5	16,000	4,000	0.15	0.65	8,000	1,000	0.15	0.65
3040-0600	R2	12,000	4,000	0.2	0.85	6,000	1,000	0.2	0.85
3050-0750	R2.5	10,000	4,000	0.25	1	5,000	1,000	0.25	1
3060-0900	R3	8,000	4,000	0.3	1.3	4,000	1,000	0.3	1.3
3080-1200 (LS)	R4	6,000	4,000	0.4	1.7	3,000	900	0.35	1.6
3100-1500	R5	4,800	4,000	0.5	2.1	2,400	800	0.4	1.9
3120-1800	R6	4,000	4,000	0.6	2.6	2,000	800	0.45	2.2

Apply when a deep tool setting causes the toolholder to extend beyond the full shank diameter and over the taper angle. Use the table below to adjust the parameters when compensating for extended overhang on the straight type design.

WORK MATERIAL		COPPER / CARBON STEELS / ALUMINUM ALLOYS S45C, S50C, A5052, A7075 (~225HB)				ALLOY STEELS / PREHARDENED STEELS SKD / NAK (~45HRC)				HARDENED STEELS STAVAX / SKD61 (45~55HRC)			
Overhang Length	Spindle Speed	Feed Rate	a _p Axial Depth	a _e Radial Depth	Spindle Speed	Feed Rate	a _p Axial Depth	a _e Radial Depth	Spindle Speed	Feed Rate	a _p Axial Depth	a _e Radial Depth	
~3D	×1	×1~1.5(※)	×1	×1	×1	×1	×1	×1	×1	×1	×1	×1	
4D	×0.9	×0.9~1.2(※)	×1	×1	×0.9	×0.9	×1	×1	×0.9	×0.9	×1	×1	
5D	×0.75	×0.75	×1	×1	×0.75	×0.75	×0.9	×0.9	×0.75	×0.75	×0.85	×0.9	
6D	×0.6	×0.6	×1	×1	×0.6	×0.6	×0.85	×0.9	×0.6	×0.6	×0.8	×0.85	
7D	×0.45	×0.4	×0.95	×0.95	×0.45	×0.4	×0.8	×0.85	×0.45	×0.4	×0.7	×0.8	
8D	×0.35	×0.3	×0.9	×0.9	×0.35	×0.3	×0.7	×0.8	×0.35	×0.3	×0.6	×0.75	

WORK MATERIAL		TITANIUM ALLOYS / STAINLESS STEELS Ti-6Al-4V / SUS				HEAT RESISTANT ALLOYS Inconel718			
Overhang Length	Spindle Speed	Feed Rate	a _p Axial Depth	a _e Radial Depth	Spindle Speed	Feed Rate	a _p Axial Depth	a _e Radial Depth	
~3D	×1	×1	×1	×1	×1	×1	×1	×1	
4D	×0.9	×0.9	×1	×1	×0.9	×0.9	×1	×1	
5D	×0.75	×0.75	×0.95	×0.95	×0.75	×0.75	×0.85	×0.9	
6D	×0.6	×0.6	×0.9	×0.9	×0.6	×0.6	×0.8	×0.85	
7D	×0.45	×0.4	×0.85	×0.9	×0.45	×0.4	×0.7	×0.8	
8D	×0.35	×0.3	×0.85	×0.85	×0.35	×0.3	×0.6	×0.75	

(※) For high efficiency milling, set the feed rate higher. For improved surface finish and/or longer tool life, reduce the feed rate.

Ø3mm Shank V Series

UDC-PCD Series

CBN Series

Square
Long Neck Square

Radius
Long Neck Radius

Taper Neck Radius

Ball / Long Shank Ball
Long Neck Ball

Taper Neck Ball

Taper

Barrel

Spiral V Cutter

Drill

Technical Data

Milling Conditions for CFB

◆Finishing (overhang length ~6D)

WORK MATERIAL		COPPER / CARBON STEELS / ALUMINUM ALLOYS S45C / S50C / A5052 / A7075 (~225HB)				ALLOY STEELS / HARDENED STEELS SKD / NAK (~45HRC)				HARDENED STEELS STAVAX / SKD61 (45~55HRC)			
Coolant		WET				DRY / OIL MIST / WET				DRY / OIL MIST			
Model Number	Radius of Ball Nose (mm)	Spindle Speed (min ⁻¹)	Feed Rate (mm/min)	a _p Axial Depth (mm)	a _e Radial Depth (mm)	Spindle Speed (min ⁻¹)	Feed Rate (mm/min)	a _p Axial Depth (mm)	a _e Radial Depth (mm)	Spindle Speed (min ⁻¹)	Feed Rate (mm/min)	a _p Axial Depth (mm)	a _e Radial Depth (mm)
3020-0300	R1	53,000	4,000	0.05	0.04	45,000	3,400	0.05	0.04	36,800	2,200	0.05	0.04
3030-0450	R1.5	41,200	4,200	0.06	0.06	35,000	3,500	0.06	0.06	28,600	2,300	0.06	0.06
3040-0600	R2	29,400	4,400	0.08	0.08	24,000	3,700	0.08	0.08	20,400	2,400	0.08	0.08
3060-0900	R3	17,600	4,600	0.1	0.12	14,000	3,900	0.1	0.12	12,300	2,600	0.1	0.12
3080-1200	R4	14,600	4,600	0.1	0.16	12,400	3,900	0.1	0.16	10,200	2,600	0.1	0.16
3100-1500	R5	11,700	4,700	0.1	0.2	9,900	4,000	0.1	0.2	8,200	2,600	0.1	0.2
3120-1800	R6	8,800	4,800	0.1	0.24	7,400	4,000	0.1	0.24	6,200	2,700	0.1	0.24

WORK MATERIAL		TITANIUM ALLOYS / STAINLESS STEELS Ti-6Al-4V / SUS				HEAT RESISTANT ALLOYS Inconel718			
Coolant		WET				WET			
Model Number	Radius of Ball Nose (mm)	Spindle Speed (min ⁻¹)	Feed Rate (mm/min)	a _p Axial Depth (mm)	a _e Radial Depth (mm)	Spindle Speed (min ⁻¹)	Feed Rate (mm/min)	a _p Axial Depth (mm)	a _e Radial Depth (mm)
3020-0300	R1	44,200	2,700	0.05	0.04	22,100	1,100	0.05	0.04
3030-0450	R1.5	34,400	2,800	0.06	0.06	17,200	1,100	0.06	0.06
3040-0600	R2	24,600	3,000	0.08	0.08	12,300	1,200	0.08	0.08
3060-0900	R3	14,800	3,200	0.1	0.12	7,400	1,300	0.1	0.12
3080-1200	R4	12,300	3,200	0.1	0.16	6,200	1,300	0.1	0.16
3100-1500	R5	9,900	3,200	0.1	0.2	5,000	1,300	0.1	0.2
3120-1800	R6	7,500	3,300	0.1	0.24	3,800	1,400	0.1	0.24

*When finishing with an overhang of over 6 x D, fine adjustments are recommended.

- 3mm Shank V Series
- UDC-PCD Series
- CBN Series
- Square
- Long Neck Square
- Radius
- Long Neck Radius
- Taper Neck Radius
- Ball / Long Shank Ball
- Long Neck Ball
- Taper Neck Ball
- Taper
- Barrel
- Spiral V Cutter
- Drill
- Technical Data

Milling Conditions for CFB

◆ Deep and high efficiency roughing (3xD overhang for straight type)

This parameter is effective in using the machine that has low acceleration and applying complex milling path that repeats accelerating/braking frequently.

WORK MATERIAL		COPPER / CARBON STEELS / ALUMINUM ALLOYS S45C / S50C / A5052 / A7075 (~225HB)				ALLOY STEELS / HARDENED STEELS SKD / NAK (~45HRC)			
Coolant		DRY (Unsuitable for Aluminum Alloys) / WET				DRY / WET			
Model Number	Radius of Ball Nose (mm)	Spindle Speed (min ⁻¹)	Feed Rate (mm/min)	a_p Axial Depth (mm)	a_e Radial Depth (mm)	Spindle Speed (min ⁻¹)	Feed Rate (mm/min)	a_p Axial Depth (mm)	a_e Radial Depth (mm)
3020-0300	R1	30,000	2,500	0.4	0.8	30,000	2,500	0.4	0.8
3030-0450	R1.5	20,000	2,500	0.6	1.2	20,000	2,500	0.6	1.2
3040-0600	R2	15,000	2,500	0.8	1.6	15,000	2,500	0.8	1.6
3060-0900	R3	10,000	2,500	1.2	2.4	10,000	2,500	1.2	2.4
3080-1200	R4	7,100	2,350	1.6	3.2	7,100	2,350	1.6	3.2
3100-1500	R5	5,400	2,250	2	4	5,400	2,250	2	4
3120-1800	R6	4,500	2,250	2.4	4.8	4,500	2,250	2.4	4.8

WORK MATERIAL		HARDENED STEELS STAVAX / SKD61 (45~55HRC)				TITANIUM ALLOYS / STAINLESS STEELS Ti-6Al-4V / SUS			
Coolant		DRY				WET			
Model Number	Radius of Ball Nose (mm)	Spindle Speed (min ⁻¹)	Feed Rate (mm/min)	a_p Axial Depth (mm)	a_e Radial Depth (mm)	Spindle Speed (min ⁻¹)	Feed Rate (mm/min)	a_p Axial Depth (mm)	a_e Radial Depth (mm)
3020-0300	R1	24,000	1,500	0.4	0.8	19,200	2,000	0.2	0.6
3030-0450	R1.5	16,000	1,500	0.6	1.2	12,800	2,000	0.3	0.9
3040-0600	R2	12,000	1,500	0.8	1.6	9,600	2,000	0.4	1.2
3060-0900	R3	8,000	1,500	1.2	2.4	6,400	2,000	0.6	1.8
3080-1200	R4	5,600	1,400	1.5	3	4,800	2,000	0.8	2.4
3100-1500	R5	4,300	1,300	1.7	3.5	3,900	2,000	1	3
3120-1800	R6	3,550	1,300	1.9	4.2	3,200	2,000	1.2	3.6

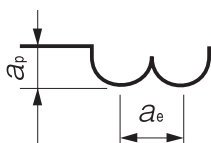

- Note:
- Fix the work piece firmly, and use a machine that has high rigidity and generates a low level of vibration especially under high efficient deep milling condition in roughing process.
 - Decrease the feed rate more than 50% from the milling parameters when slot milling.
 - Decrease both spindle speed and feed rate proportionally when the milling parameters exceed the machines maximum speed, or when the tool is chattering and heats up to a red color.
 - Decrease both spindle speed and feed rate 10% for slope milling.
 - Decrease both spindle speed and feed rate to meet required precision and to prevent the shank making contact with the work piece.
 - DRY: air blow, WET: water soluble or oil coolant.
 - A long overhang may cause tool deflection, leaving uncut material.

CFB Series
SKD61 (47HRC)
Milling Video



Ø3mm Shank
V Series

UDC-PCD
Series

CBN
Series

Square

Long Neck
Square

Radius

Long Neck
Radius

Taper Neck
Radius

Ball / Long
Shank Ball

Long Neck
Ball

Taper Neck
Ball

Taper

Barrel

Spiral
V Cutter

Drill

Technical Data



Size R0.3~R6

DLC-CFB



R0.3~R1.5

R2~R3

R4~R6

R2~R6

Material Applications (★ Highly Recommended ● Recommended ○ Suggested)

Work Material																	
Carbon Steels S45C S55C	Alloy Steels SK / SCM SUS	Prehardened Steels NAK HPM	Hardened Steels					Cast Iron	Aluminum Alloys	Graphite	Copper	Plastics	Glass Filled Plastics	Titanium Alloys	Heat Resistant Alloys	Cemented Carbide	Hard Brittle (Non-Metallic) Materials
			~50HRC	~55HRC	~60HRC	~65HRC	~70HRC										
								★			○	○					

Features

Achieves dramatically higher feed rates with 3 flutes, shortening roughing time.

DLC coating offers excellent welding and wear resistance.

Offers highly efficient milling even for a slow-moving shape, with deep cut milling.

3 flute variable pitch design reduces chattering.

The 3 slots at the tip offers chip evacuation and improved surface finish. (Except R0.75 or below)

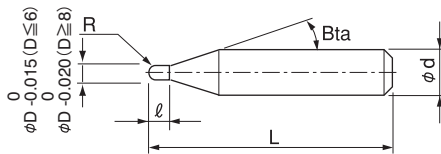
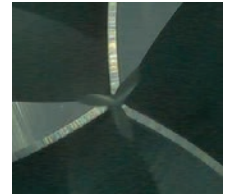

The shank taper angle shown is not an exact value and to avoid contact with the work piece, we recommend the user controls the precise value of this angle. Shank taper angle should not make contact with the work piece.

Total 14 models

Unit (mm)

Model Number	Radius of Ball Nose R	Length of Cut ℓ	Shank Taper Angle Bta	Overall Length L	Shank Diameter φd	Suggested Retail Price ¥
DLC-CFB 3006-0090	R0.3	0.9	16°	50	4	7,220
DLC-CFB 3008-0120	R0.4	1.2	16°	50	4	7,040
DLC-CFB 3010-0150	R0.5	1.5	16°	50	4	6,540
DLC-CFB 3015-0225	R0.75	2.25	16°	50	4	7,220
DLC-CFB 3020-0300	R1	3	16°	50	4	7,040
DLC-CFB 3030-0450	R1.5	4.5	16°	60	6	7,220
DLC-CFB 3040-0600-4	R2	6	—	70	4	6,880
DLC-CFB 3040-0600			16°	70	6	7,220
DLC-CFB 3050-0750	R2.5	7.5	16°	80	6	8,170
DLC-CFB 3060-0900	R3	9	—	80	6	9,030
DLC-CFB 3080-1200	R4	12	—	90	8	12,900
DLC-CFB 3080-1200LS			—	120	8	14,600
DLC-CFB 3100-1500	R5	15	—	100	10	17,100
DLC-CFB 3120-1800	R6	18	—	110	12	21,600

Milling Conditions for DLC-CFB

3 Flutes

◆Roughing

WORK MATERIAL		ALUMINUM ALLOYS A5052 etc.				ALUMINUM ALLOYS A7075 etc.			
Model Number	Radius of Ball Nose (mm)	Spindle Speed (min ⁻¹)	Feed Rate (mm/min)	a_p Axial Depth (mm)	a_e Radial Depth (mm)	Spindle Speed (min ⁻¹)	Feed Rate (mm/min)	a_p Axial Depth (mm)	a_e Radial Depth (mm)
3006-0090	R0.3	30,000	1,200	0.03	0.13	30,000	1,000	0.03	0.13
3008-0120	R0.4	30,000	1,500	0.04	0.17	30,000	1,250	0.04	0.17
3010-0150	R0.5	30,000	1,800	0.05	0.21	30,000	1,500	0.05	0.21
3015-0225	R0.75	30,000	3,000	0.075	0.32	30,000	2,500	0.075	0.32
3020-0300	R1	30,000	3,840	0.2	0.6	30,000	3,200	0.2	0.6
3030-0450	R1.5	24,000	4,800	0.3	0.9	24,000	4,000	0.3	0.9
3040-0600(-4)	R2	18,000	4,800	0.4	1.2	18,000	4,000	0.4	1.2
3050-0750	R2.5	15,000	4,800	0.5	1.5	15,000	4,000	0.5	1.5
3060-0900	R3	12,000	4,800	0.6	1.8	12,000	4,000	0.6	1.8
3080-1200(LS)	R4	9,000	4,800	0.8	2.4	9,000	4,000	0.8	2.4
3100-1500	R5	7,200	4,800	1	3	7,200	4,000	1	3
3120-1800	R6	6,000	4,800	1.2	3.6	6,000	4,000	1.2	3.6

Apply when a deep tool setting causes the tool holder to extend beyond the full shank diameter and over the taper angle. Use the table below to adjust the parameters when compensating for extended overhang on the straight type design.

WORK MATERIAL	ALUMINUM ALLOYS A5052, A7075			
Overhang Length	Spindle Speed	Feed Rate	a_p Axial Depth	a_e Radial Depth
~3D	×1	×1~1.5(※)	×1	×1
4D	×0.9	×0.9~1.2(※)	×1	×1
5D	×0.75	×0.75	×1	×1
6D	×0.6	×0.6	×1	×1
7D	×0.45	×0.4	×0.95	×0.95
8D	×0.35	×0.3	×0.9	×0.9

(※)For high efficiency milling, set the feed rate higher. For improved surface finish and/or longer tool life, reduce the feed rate.

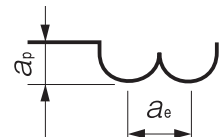

- 3mm Shank V Series
- UDC-PCD Series
- CBN Series
- Square
- Long Neck Square
- Radius
- Long Neck Radius
- Taper Neck Radius
- Ball / Long Shank Ball
- Long Neck Ball
- Taper Neck Ball
- Taper
- Barrel
- Spiral V Cutter
- Drill
- Technical Data

Milling Conditions for DLC-CFB

◆Finishing (overhang length ~6D)

WORK MATERIAL		ALUMINUM ALLOYS A5052				ALUMINUM ALLOYS A7075			
Model Number	Radius of Ball Nose (mm)	Spindle Speed (min ⁻¹)	Feed Rate (mm/min)	a _p Axial Depth (mm)	a _e Radial Depth (mm)	Spindle Speed (min ⁻¹)	Feed Rate (mm/min)	a _p Axial Depth (mm)	a _e Radial Depth (mm)
3020-0300	R1	53,000	4,800	0.05	0.04	53,000	4,000	0.05	0.04
3030-0450	R1.5	42,100	5,040	0.06	0.06	42,100	4,200	0.06	0.06
3040-0600	R2	29,400	5,280	0.08	0.08	29,400	4,400	0.08	0.08
3060-0900	R3	17,600	5,520	0.1	0.12	17,600	4,600	0.1	0.12
3080-1200	R4	14,600	5,520	0.1	0.2	14,600	4,600	0.1	0.2
3100-1500	R5	11,700	5,640	0.1	0.2	11,700	4,700	0.1	0.2
3120-1800	R6	8,800	5,760	0.1	0.24	8,800	4,800	0.1	0.24

Adjustments are recommended when finishing with an overhang of over 6 x D.

◆Deep and high efficiency roughing (overhang length ~3D for straight type)

This parameter is effective in using the machine that has low acceleration and applying complex milling path that repeats accelerating/braking frequently.

WORK MATERIAL		ALUMINUM ALLOYS A5052				ALUMINUM ALLOYS A7075			
Model Number	Radius of Ball Nose (mm)	Spindle Speed (min ⁻¹)	Feed Rate (mm/min)	a _p Axial Depth (mm)	a _e Radial Depth (mm)	Spindle Speed (min ⁻¹)	Feed Rate (mm/min)	a _p Axial Depth (mm)	a _e Radial Depth (mm)
3020-0300	R1	30,000	3,000	0.4	0.8	30,000	2,500	0.4	0.8
3030-0450	R1.5	20,000	3,000	0.6	1.2	20,000	2,500	0.6	1.2
3040-0600	R2	15,000	3,000	0.8	1.6	15,000	2,500	0.8	1.6
3060-0900	R3	10,000	3,000	1.2	2.4	10,000	2,500	1.2	2.4
3080-1200	R4	7,100	2,820	1.6	3.2	7,100	2,350	1.6	3.2
3100-1500	R5	5,400	2,700	2	4	5,400	2,250	2	4
3120-1800	R6	4,500	2,700	2.4	4.8	4,500	2,250	2.4	4.8

Note:

- Fix the work piece firmly, and use a machine that has high rigidity and generates a low level of vibration especially under high efficient deep milling condition in roughing process.
- Decrease the feed rate more than 50% from the milling parameters when slot milling.
- Decrease both spindle speed and feed rate proportionally when the milling parameters exceed the machines maximum speed, or when the tool is chattering and heats up to a red color.
- Decrease both spindle speed and feed rate 10% for slope milling.
- Decrease both spindle speed and feed rate to meet required precision and to prevent the shank making contact with the work piece.
- Recommend water soluble or oil coolant.
- A long overhang may cause tool deflection, leaving uncut material.

Mold Milling Example for Plastic Container
DLC-CFB R4 × L12

A5052

3 Flutes



Tool after milling

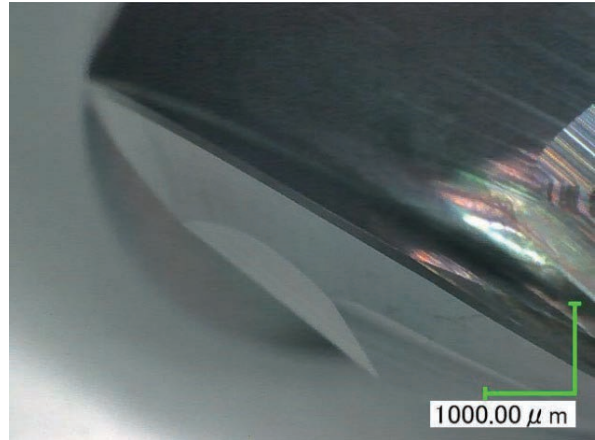

More tool life left

Work Size : 130 x 105 x 95 mm
Pocket Size : ϕ 80.5 x Depth 25 mm
Coolant : Water Soluble (Through Spindle)

No.	Milling Process	Tool	Spindle Speed (min ⁻¹)	Feed Rate (mm/min)	a_p (mm)	a_e (mm)	Allowance (mm)	Milling Spot	Cycle Time (h:min)
1	Roughing	DLC-CFB 3080-1200	8,100	4,320	0.8	2.4	0.01	Pocket & Half Pocket	1:05
2	Finishing				0.0001 (Cusp Height)	0.05	0	Pocket	2:58
								Total	4:03

- ϕ 3mm Shank V Series
- UDC-PCD Series
- CBN Series
- Square
- Long Neck Square
- Radius
- Long Neck Radius
- Taper Neck Radius
- Ball / Long Shank Ball
- Long Neck Ball
- Taper Neck Ball
- Taper
- Barrel
- Spiral V Cutter
- Drill
- Technical Data



Size R1~R6

HFB

Super
MG

HARD
MAX

40°

R
±0.005
R1~R1.5

R
±0.007
R2~R3

R
±0.01
R4~R6

Shank Dia
0/-0.005

Patented in Japan, China, Taiwan, Korea, Germany, Switzerland, and Liechtenstein

Material Applications (★ Highly Recommended ● Recommended ○ Suggested)

Work Material																	
Carbon Steels S45C S55C	Alloy Steels SK / SCM SUS	Prehardened Steels NAK HPM	Hardened Steels					Cast Iron	Aluminum Alloys	Graphite	Copper	Plastics	Glass Filled Plastics	Titanium Alloys	Heat Resistant Alloys	Cemented Carbide	Hard Brittle (Non-Metallic) Materials
			~50HRC	~55HRC	~60HRC	~65HRC	~70HRC										
			●	●	●	●	●										

- 3mm Shank V Series
- UDC-PCD Series
- CBN Series
- Square
- Long Neck Square
- Radius
- Long Neck Radius
- Taper Neck Radius
- Ball / Long Shank Ball
- Long Neck Ball
- Taper Neck Ball
- Taper
- Barrel
- Spiral V Cutter
- Drill
- Technical Data

Features

Dramatically improved the milling efficiency. Maximum 27 times higher chip evacuation compared to conventional tool.
New ball tip design offers polish-less bottom surface finishing.
Affordable pricing.
Diameter Tolerance: 0/-0.02

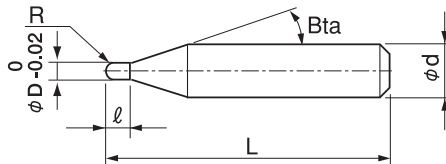

The shank taper angle shown is not an exact value and to avoid contact with the work piece, we recommend the user controls the precise value of this angle. Shank taper angle should not make contact with the work piece.

Total 8 models

Unit (mm)

Model Number	Radius of Ball Nose R	Length of Cut ℓ	Shank Taper Angle Bta	Overall Length L	Shank Diameter φd	Suggested Retail Price ¥
HFB 4020-0300	R1	3	16°	50	4	6,720
HFB 4020-0300-6	R1	3	16°	50	6	7,790
HFB 4030-0450	R1.5	4.5	16°	60	6	6,890
HFB 4040-0600	R2	6	16°	70	6	6,890
HFB 4060-0900	R3	9	—	80	6	8,610
HFB 4080-1200	R4	12	—	90	8	12,300
HFB 4100-1500	R5	15	—	100	10	16,320
HFB 4120-1800	R6	18	—	110	12	20,660



Size R1~R6

HFB Short Shank

Patented in Japan, China, Taiwan, Korea, Germany, Switzerland, and Liechtenstein

HFB-S

Super MG

HARD MAX

40°

R ±0.005
R1~R1.5

R ±0.007
R2~R3

R ±0.01
R4~R6

Shank Dia 0/-0.005

Material Applications (★ Highly Recommended ● Recommended ○ Suggested)

Work Material																	
Carbon Steels S45C S55C	Alloy Steels SK / SCM SUS	Prehardened Steels NAK HPM	Hardened Steels					Cast Iron	Aluminum Alloys	Graphite	Copper	Plastics	Glass Filled Plastics	Titanium Alloys	Heat Resistant Alloys	Cemented Carbide	Hard Brittle (Non-Metallic) Materials
			~50HRC	~55HRC	~60HRC	~65HRC	~70HRC										
			●	●	●	●	●										

Features

Compatible with shrink-fit toolholder systems for high efficiency.
A shorter overhang offers higher feed rates and precision.
Diameter Tolerance: 0/-0.02

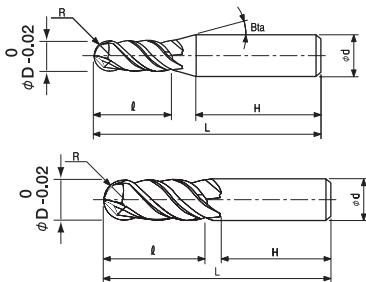

The shank taper angle and the shank length (H) shown are not an exact value and to avoid contact with the work piece, we recommend the user controls the precise value of this angle. Shank taper angle should not make contact with the work piece.

Total 7 models

Unit (mm)

Model Number	Radius of Ball Nose R	Length of Cut ℓ	Shank Taper Angle Bta	Overall Length L	Shank Diameter φd	Shank Length H	Suggested Retail Price ¥
HFB 4020-0300S	R1	3	16°	40	4	31.0	6,720
HFB 4030-0450S	R1.5	4.5	16°	40	4	30.5	6,890
HFB 4040-0600S	R2	6	16°	45	6	32.5	6,890
HFB 4060-0900S	R3	9	—	50	6	34.5	8,610
HFB 4080-1200S	R4	12	—	60	8	40.5	12,300
HFB 4100-1500S	R5	15	—	60	10	35.5	16,320
HFB 4120-1800S	R6	18	—	60	12	31.5	20,660

4 Flutes

φ3mm Shank V Series

UDC-PCD Series

CBN Series

Square

Long Neck Square

Radius

Long Neck Radius

Taper Neck Radius

Ball / Long Shank Ball

Long Neck Ball

Taper Neck Ball

Taper

Barrel

Spiral V Cutter

Drill

Technical Data

Milling Conditions for HFB / HFB-S

◆Roughing

WORK MATERIAL		PREHARDENED STEELS NAK80 (35~45HRC) Coolant: Water Soluble / Air Blow / Oil Mist				HARDENED STEELS STAVAX / SKD61 (45~55HRC) Coolant: Air Blow / Oil Mist			
Model Number	Radius of Ball Nose (mm)	Spindle Speed (min ⁻¹)	Feed Rate (mm/min)	a _p Axial Depth (mm)	a _e Radial Depth (mm)	Spindle Speed (min ⁻¹)	Feed Rate (mm/min)	a _p Axial Depth (mm)	a _e Radial Depth (mm)
4020-0300	R1	20,000	1,500	0.5	0.8	16,000	1,500	0.6	0.9
4030-0450	R1.5	16,000	2,000	0.6	0.9	10,500	1,500	0.9	1.35
4040-0600	R2	15,000	3,000	0.4	0.8	9,000	3,000	0.7	1.4
4060-0900	R3	9,000	2,500	0.5	1	8,000	3,500	0.6	1.8
4080-1200	R4	CFB Series are Recommended				6,200	3,000	0.75	2.1
4100-1500	R5					4,500	2,700	0.85	2.5
4120-1800	R6					3,750	2,700	0.95	3

WORK MATERIAL		HARDENED STEELS YXR33 / SKD11 (55~60HRC) Coolant: Air Blow / Oil Mist				HARDENED STEELS HAP10 / SKD11 / YXR7 (60~65HRC) Coolant: Air Blow / Oil Mist			
Model Number	Radius of Ball Nose (mm)	Spindle Speed (min ⁻¹)	Feed Rate (mm/min)	a _p Axial Depth (mm)	a _e Radial Depth (mm)	Spindle Speed (min ⁻¹)	Feed Rate (mm/min)	a _p Axial Depth (mm)	a _e Radial Depth (mm)
4020-0300	R1	10,000	1,500	0.4	0.8	8,500	1,200	0.3	0.7
4030-0450	R1.5	6,500	1,500	0.6	1.2	5,500	1,200	0.5	1.1
4040-0600	R2	5,500	1,750	0.6	1.2	6,200	2,000	0.45	1
4060-0900	R3	4,500	1,750	0.6	1.5	5,000	2,000	0.45	1.2
4080-1200	R4	3,750	1,500	0.7	1.75	4,500	1,800	0.5	1.4
4100-1500	R5	3,000	1,500	0.75	2	3,600	1,800	0.6	1.6
4120-1800	R6	2,500	1,500	0.9	2.4	3,000	1,800	0.7	1.8

WORK MATERIAL		HARDENED STEELS HAP72 (65~70HRC) Coolant: Air Blow / Oil Mist			
Model Number	Radius of Ball Nose (mm)	Spindle Speed (min ⁻¹)	Feed Rate (mm/min)	a _p Axial Depth (mm)	a _e Radial Depth (mm)
4020-0300	R1	10,500	750	0.2	0.6
4030-0450	R1.5	7,000	750	0.25	0.8
4040-0600	R2	7,500	1,200	0.2	0.6
4060-0900	R3	5,000	1,500	0.3	0.9
4080-1200	R4	4,000	1,500	0.3	1
4100-1500	R5	3,000	1,500	0.3	1.2
4120-1800	R6	2,500	1,300	0.3	1.4

- 3mm Shank V Series
- UDC-PCD Series
- CBN Series
- Square
- Long Neck Square
- Radius
- Long Neck Radius
- Taper Neck Radius
- Ball / Long Shank Ball
- Long Neck Ball
- Taper Neck Ball
- Taper
- Barrel
- Spiral V Cutter
- Drill
- Technical Data

Milling Conditions for HFB / HFB-S

Please adjust milling parameter according to overhang length, referring to the following table.

Radius of Ball Nose R1 ($\phi 4$ shank), R1.5

Overhang Length	Spindle Speed (min ⁻¹)	Feed Rate (mm/min)	a_p (mm)	a_e (mm)
$\phi D \times 5$ or below	$\times 1$	$\times 1$	$\times 1$	$\times 1$
$\sim \phi D \times 6$	$\times 0.9$	$\times 0.9$	$\times 0.95$	$\times 0.95$
$\sim \phi D \times 7$	$\times 0.8$	$\times 0.8$	$\times 0.9$	$\times 0.95$
$\sim \phi D \times 8$	$\times 0.7$	$\times 0.7$	$\times 0.85$	$\times 0.9$
$\sim \phi D \times 9$	$\times 0.65$	$\times 0.6$	$\times 0.8$	$\times 0.9$
$\sim \phi D \times 10$	$\times 0.55$	$\times 0.5$	$\times 0.75$	$\times 0.85$

Radius of Ball Nose R1 ($\phi 6$ shank)

Overhang Length	Spindle Speed (min ⁻¹)	Feed Rate (mm/min)	a_p (mm)	a_e (mm)
$\phi D \times 6$	$\times 1$	$\times 1$	$\times 1$	$\times 1$
$\sim \phi D \times 7$	$\times 0.85$	$\times 0.9$	$\times 0.95$	$\times 0.95$
$\sim \phi D \times 8$	$\times 0.7$	$\times 0.8$	$\times 0.9$	$\times 0.9$
$\sim \phi D \times 9$	$\times 0.55$	$\times 0.75$	$\times 0.85$	$\times 0.9$
$\sim \phi D \times 10$	$\times 0.4$	$\times 0.65$	$\times 0.8$	$\times 0.85$

Radius of Ball Nose R1.5 (Short shank)

Overhang Length	Spindle Speed (min ⁻¹)	Feed Rate (mm/min)	a_p (mm)	a_e (mm)
$\phi D \times 5$ or below	$\times 1$	$\times 1$	$\times 1$	$\times 1$
$\sim \phi D \times 6$	$\times 0.55$	$\times 0.3$	$\times 0.4$	$\times 0.55$

Radius of Ball Nose R2 or above

Overhang Length	Spindle Speed (min ⁻¹)	Feed Rate (mm/min)	a_p (mm)	a_e (mm)
$\phi D \times 3$ or below	$\times 1$	$\times 1$	$\times 1$	$\times 1$
$\sim \phi D \times 3.5$	$\times 1$	$\times 0.85$	$\times 0.85$	$\times 0.9$
$\sim \phi D \times 4$	$\times 1$	$\times 0.8$	$\times 0.7$	$\times 0.8$
$\sim \phi D \times 4.5$	$\times 0.85$	$\times 0.55$	$\times 0.6$	$\times 0.75$
$\sim \phi D \times 5$	$\times 0.7$	$\times 0.35$	$\times 0.6$	$\times 0.75$
$\sim \phi D \times 5.5$	$\times 0.55$	$\times 0.25$	$\times 0.55$	$\times 0.7$
$\sim \phi D \times 6$	$\times 0.4$	$\times 0.15$	$\times 0.5$	$\times 0.7$

* Refer to next page for finishing condition.

HFB Series
SKD11 (60HRC)
Milling Video



Milling Conditions for HFB / HFB-S

◆Finishing (overhang length ~6D)

WORK MATERIAL		PREHARDENED STEELS / HARDENED STEELS (35~60HRC) Coolant: Oil Mist			
Model Number	Radius of Ball Nose (mm)	Spindle Speed (min ⁻¹)	Feed Rate (mm/min)	a_p Axial Depth (mm)	a_e Radial Depth (mm)
4020-0300	R1	26,000	2,000	0.02	0.06
4030-0450	R1.5	25,000	1,800	0.03	0.07
4040-0600	R2	22,500	1,500	0.04	0.08
4060-0900	R3	15,000	1,000	0.06	0.12
4080-1200	R4	11,250	750	0.08	0.16
4100-1500	R5	9,000	600	0.1	0.2
4120-1800	R6	7,500	500	0.12	0.24

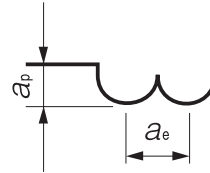

Note:

- Decrease the feed rate more than 50% from the milling parameters when slot milling.
- Decrease both spindle speed and feed rate proportionally when the milling parameters exceed the machines maximum speed, or when the tool is chattering and heats up to a red color.
- Adjustments are recommended when finishing with an overhang of over 6xD.
- Recommend air blow or oil mist. For materials under 45HRC, recommend water soluble coolant.

Feature 1 Special Design Achieves Outstanding Chip Evacuation

HFB Design

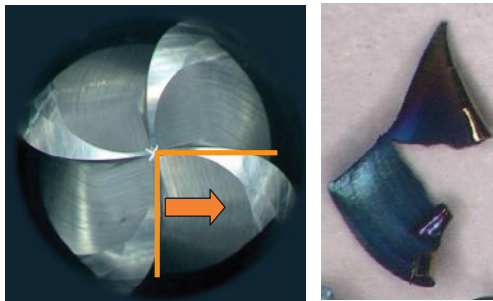

Flat (Non-rolled up) chip shape shows smooth chip evacuation.

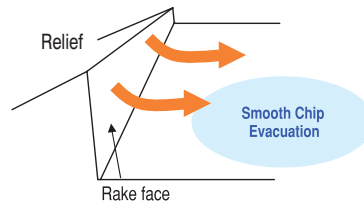

Conventional Design

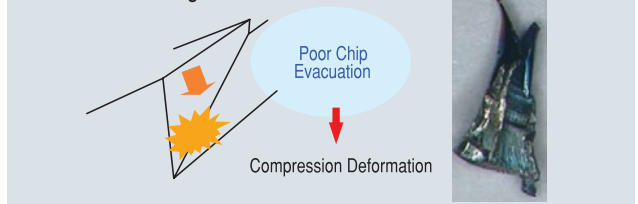

Smooth chip evacuation achieves more stable milling.

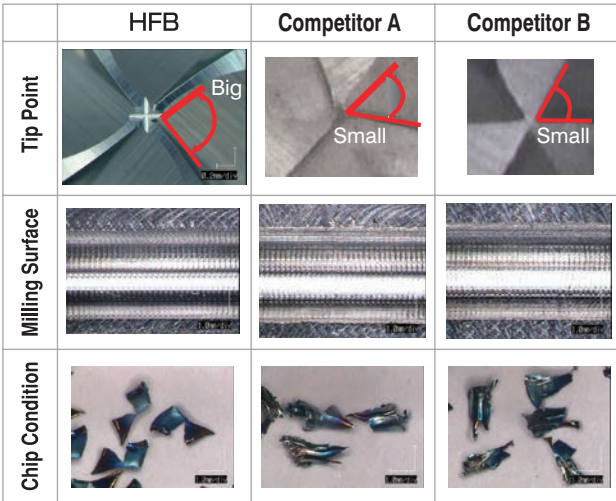

Tool	R2
Work Material	YXR33 (58HRC)
Spindle Speed	6,000 min ⁻¹
Feed Rate	2,400 mm/min (Slotting : 1,200 mm/min)
a_p	1 mm (0.25D)
a_e	1 mm (0.25D)
Overhang Length	15 mm
Coolant	Air Blow (Through Spindle)
Pocket Size	100 × 20 × 6 mm (X × Y × Z)
Cycle Time	28.2 min

D : Outside Diameter

The large pocket design of the HFB promotes better chip evacuation and longer tool life when compared to a conventional design which shows premature damage.

Feature 2 Polish-less Milling by 4 Tip Grooves

STAVAX (53HRC) Milling Example: Flat Surface Finishing HFB (R3)

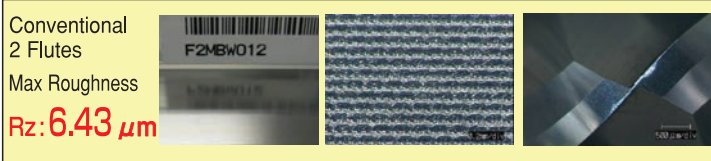
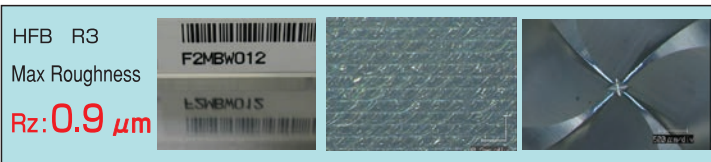

Spindle Speed	12,800 min ⁻¹
Feed Rate	2,500 mm/min
a_p	0.06 mm (0.01D)
a_e	0.12 mm (0.02D)
Coolant	Oil Mist

4 grooves on the tip point help surface finishing process. Max roughness values was 0.9 μ m on 1 hour testing.

The tool condition is better than conventional 2 Flutes.

Tip point

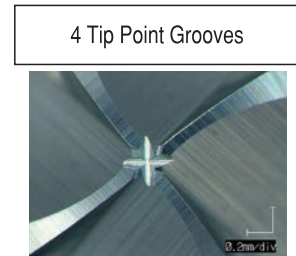
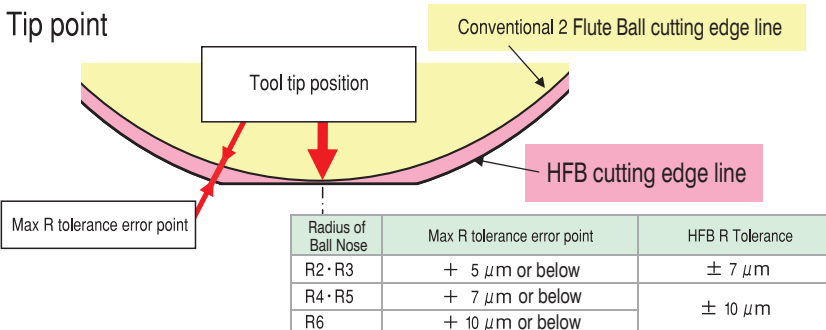

Smooth chip evacuation reduces damage at the tip.

4 Flutes

\varnothing 3mm Shank
V Series

UDC-PCD
Series

CBN
Series

Square

Long Neck
Square

Radius

Long Neck
Radius

Taper Neck
Radius

Ball / Long
Shank Ball

Long Neck
Ball

Taper Neck
Ball

Taper

Barrel

Spiral
V Cutter

Drill

Technical Data



Size R2~R10

CGB4000



Material Applications (★ Highly Recommended ● Recommended ○ Suggested)

Work Material																	
Carbon Steels	Alloy Steels	Prehardened Steels	Hardened Steels					Cast Iron	Aluminum Alloys	Graphite	Copper	Plastics	Glass Filled Plastics	Titanium Alloys	Heat Resistant Alloys	Cemented Carbide	Hard Brittle (Non-Metallic) Materials
			~50HRC	~55HRC	~60HRC	~65HRC	~70HRC										
S45C S55C	SK / SCM SUS	NAK HPM							○	★	○	○	○				

Features

Designed for milling Graphite.
The chosen carbide grade offers excellent wear resistance.
Refer to page 440 for 2 flute CGB.

Actual measurement is necessary when using longer length of cut than the written length.

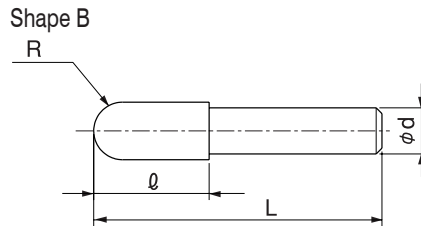
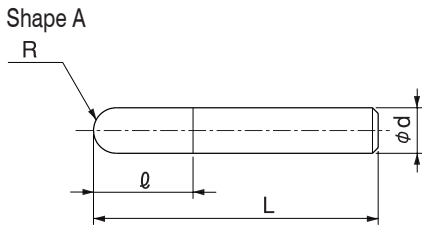

Total 9 models

Unit (mm)

Model Number	Radius of Ball Nose R	Length of Cut l	Overall Length L	Shank Diameter φd	Shape	Suggested Retail Price ¥
CGB 4040	R2	20	100	4	A	21,900
CGB 4050	R2.5	20	100	5	A	22,200
CGB 4060	R3	30	150	6	A	25,200
CGB 4070	R3.5	30	150	6	B	28,250
CGB 4080	R4	40	150	8	A	31,900
CGB 4100	R5	50	180	10	A	39,380
CGB 4120	R6	55	200	12	A	46,090
CGB 4160	R8	60	200	16	A	65,010
CGB 4200	R10	60	250	20	A	98,560

Milling Conditions for CGB (4 Flutes)

WORK MATERIAL		GRAPHITE			
Model Number	Radius of Ball Nose (mm)	Spindle Speed (min ⁻¹)	Feed Rate (mm/min)	a_p Axial Depth (mm)	a_e Radial Depth (mm)
4040	R2	15,000	1,350~1,600	1.2	2.8
4050	R2.5	15,000	1,350~1,600	1.5	3.5
4060	R3	15,000	1,900~2,300	1.8	4.2
4070	R3.5	9,000	1,900~2,300	2.1	4.9
4080	R4	8,000	1,900~2,300	2.4	5.6
4100	R5	6,500	2,000~2,500	3	7
4120	R6	5,300	2,000~2,500	3.6	8.4
4160	R8	4,000	2,000~2,500	4.8	11.2
4200	R10	3,200	2,000~2,500	6	14

For 3D milling / Finishing
Milling Amount (mm)

$a_p = 0.3D$

$a_e = 0.7D$

D : Outside Diameter (mm)

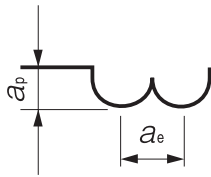

Note:

- Use a milling machine dedicated for Graphite.
- Recommend air blow for Graphite.

Other series for Graphite milling

Square / Long Neck Square

(★ Highly Recommended ● Recommended ○ Suggested)

Number of Flutes, Tool Type	Model Number	Appearance	Coating	Size	Aluminum Alloys	Graphite	Copper	Plastics	Glass Filled Plastics	Hard Brittle (Non-Metallic) Materials	Page
					○	★	○	○	○	●	
4 flutes Square	CGE		Non-coat	$\phi 2 \sim \phi 20$	○	★	○	○	○		236
2 flutes Square	DCES 2000		DIA	$\phi 0.2 \sim \phi 6$	○	★	○	○	●	○	188
4 flutes Square	DCES 4000		DIA	$\phi 3 \sim \phi 10$	○	★	○	○	●	○	234
2 flutes Long Neck Square	DCLS		DIA	$\phi 0.4 \sim \phi 6$	○	★	○	○	●	○	266

Long Neck Radius

4 flutes Long Neck Radius	DCLRS		DIA	$\phi 1 \sim \phi 6$	○	★	○	○	●	○	396
---------------------------	-------	--	-----	----------------------	---	---	---	---	---	---	-----

Ball / Long Neck Ball / Taper Neck Ball

2 flutes Ball	CGB 2000		Non-coat	R0.2~R6	○	★	○	○	○		440
4 flutes Ball	CGB 4000		Non-coat	R2~R10	○	★	○	○	○		458
2 flutes Ball	DCB		DIA	R0.5~R6	○	★	○	○	●	○	438
2 flutes Long Neck Ball	DCLB		DIA	R0.2~R3	○	★	○	○	●	○	512
2 flutes Taper Neck Ball	DCTNB		DIA	R0.5~R1	○	★	○	○	●	○	556

4 Flutes

φ3mm Shank
V Series

UDC-PCD
Series

CBN
Series

Square

Square

Long Neck
Square

Radius

Radius

Long Neck
Radius

Taper Neck
Radius

Radius

Ball / Long
Shank Ball

Ball

Long Neck
Ball

Taper Neck
Ball

Ball

Taper

Taper

Barrel

Spiral
V Cutter

Drill

Technical Data

Technical Data



Size **R0.05~R3**

HGLB

Super
MG

HMG
COAT

30°

R
±0.002
R0.05~R0.075

R
±0.003
R0.1~R2

R
±0.005
R2.5~R3

Shank Dia
0/-0.004

Back Taper
Geometry

~ Except for R0.4 or below.
 $\ell_1 / D \leq 10$

Material Applications (★ Highly Recommended ● Recommended ○ Suggested)

Work Material																	
Carbon Steels S45C S55C	Alloy Steels SK / SCM SUS	Prehardened Steels NAK HPM	Hardened Steels					Cast Iron	Aluminum Alloys	Graphite	Copper	Plastics	Glass Filled Plastics	Titanium Alloys	Heat Resistant Alloys	Cemented Carbide	Hard Brittle (Non-Metallic) Materials
			~ 50HRC	~ 55HRC	~ 60HRC	~ 65HRC	~ 70HRC										
		○	●	●	●	★	★										

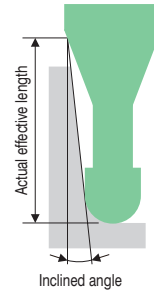
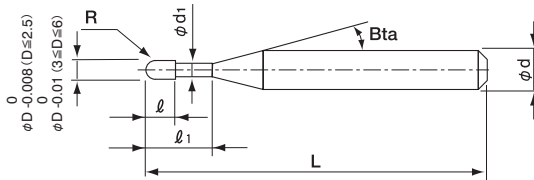

The shank taper angle shown is not an exact value and to avoid contact with the workpiece, we recommend the user controls the precise value of this angle. Shank taper angle should not make contact with the work piece.

New carbide materials with excellent wear resistance

Adopted new coating "HMGCOAT"



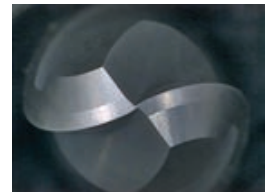







Coating series	COPPER	CARBON STEELS	PREHARDENED STEELS	HARDENED STEELS				
				~ 50 HRC	~ 55 HRC	~ 60 HRC	~ 65 HRC	~ 70 HRC
HMG COAT			○	○	○	●	★	★
HMW COAT	○	○	●	●	●	★	●	●
HARD MAX	○	○	●	●	●	●	○	



- φ3mm Shank V Series
- UDC-PCD Series
- CBN Series
- Square
- Long Neck Square
- Radius
- Long Neck Radius
- Taper Neck Radius
- Ball / Long Shank Ball
- Long Neck Ball
- Taper Neck Ball
- Taper
- Barrel
- Spiral V Cutter
- Drill
- Technical Data

Super negative design specialized for high hardness of 60HRC or above

Long Neck Ball series for Steels

Number of Flutes	Model Number	Features	Ball tip design	Copper	Carbon Steels	Pre hardened Steels	HARDENED STEELS					Alloy Steels	Aluminum Alloys	Plastics	Titanium/Heat Resistant Alloys	Page
							~ 50 HRC	~ 55 HRC	~ 60 HRC	~ 65 HRC	~ 70 HRC					
2 Flutes	HGLB		Best suited for Hard Materials	Super Negative		○	○	●	●	●	★	★				460
	HWLB		For Hard Materials	Negative		○	○	●	★	★	★	●	●		○	470
	HSLB HSLB-S		For Hard Materials Multi-purpose	Negative		○	○	●	●	●	○				○	476 492
	CSELB		Multi-purpose Excellent surface quality	Standard		●	●	●	●	●			●	●	○	496
3 Flutes	CFLB		Multi-purpose Excellent surface quality	Positive		●	●	●	●			●	●	○	●	530

High Precision Diameter Tolerance / Radius Accuracy / Shank Diameter Tolerance

HSLB Tolerance

Radius of Ball Nose	Diameter Tolerance	Ball Radius Accuracy	Shank Diameter Tolerance
R0.03 ~ R0.075	0/-0.01	±0.002	0/-0.005 (h5)
R0.1 ~ R3	0/-0.015	±0.005	

HGLB Tolerance

Radius of Ball Nose	Diameter Tolerance	Ball Radius Accuracy	Shank Diameter Tolerance
R0.05 ~ R0.075	0/-0.008	±0.002	0/-0.004 (h4)
R0.1 ~ R1.25		±0.003	
R1.5 ~ R2	0/-0.01	±0.005	
R2.5 ~ R3			

Shank diameter tolerance h4!

Spur Gear

HAP72 (69HRC)



4 Flute / 6 Flute Radius End Mills for Hard Materials
HMERS
(P320)



Coolant : Air Blow
(Through Spindle)
Work size : ϕ 50.4 × Depth 11 mm

Ball End Mills for Hard Materials
HGB (P422)



Long Neck Ball End Mills for Hard Materials
HGLB



Process	Tool	Spindle Speed (min ⁻¹)	Feed Rate (mm/min)	a_p (mm)	a_e (mm)	Allowance (mm)	Cycle Time (h:m)	Milling Method
Roughing	HGB R1.5	8,300	1,140	0.12	0.55	0.02	1:41	Roughing
Roughing	HGLB R1 × EL6	12,300	1,800	0.06	0.3	0.02	0:06	Rest machining
Semi-Finishing			1,800	0.06	0.05	0.01	0:53	Semi-Finishing
Finishing			900	0.00015 Cusp Height	—	0	0:09	45° surface / Finishing
Finishing	HMERS ϕ 3 × CR0.1	8,600	465	0.5	1	0	0:02	Above the gear teeth / Finishing
Finishing			1,500	0.0002 Cusp Height	1	0	0:01	Bottom surface of cylindrical part / Finishing
Finishing	HGLB R0.5 × EL6	20,000	800	0.00015 Cusp Height	—	0	0:55	Gear wall / Finishing
Finishing			800	0.01	0.04	0	0:51	Gear bottom / Finishing
Total							4:38	

ϕ 3mm Shank
V Series

UDC-PCD
Series

CBN
Series

Square

Long Neck
Square

Radius

Long Neck
Radius

Taper Neck
Radius

Ball / Long
Shank Ball

Long Neck
Ball

Taper Neck
Ball

Taper

Barrel

Spiral
V Cutter

Drill

Technical Data

Total 155 models

Unit (mm)

Model Number	Radius of Ball Nose R	Effective Length ℓ_1	Length of Cut ℓ	Neck Diameter ϕd_1	Shank Taper Angle β	Overall Length L	Shank Diameter ϕd	Suggested Retail Price ¥	Effective Length by Inclined Angles						
									30°	1°	1°30'	2°	3°		
HGLB 2001-002	RO.05	0.2	0.08	0.095	16°	45	4	12,360	0.22	0.24	0.26	0.28	0.31		
HGLB 2001-003		0.3				45	4	12,360	0.33	0.36	0.38	0.40	0.44		
HGLB 2001-005		0.5				45	4	13,440	0.55	0.58	0.61	0.64	0.68		
HGLB 20015-003	RO.075	0.3	0.12	0.14	16°	45	4	14,400	0.35	0.37	0.39	0.41	0.44		
HGLB 20015-005		0.5				45	4	15,240	0.56	0.59	0.62	0.64	0.69		
HGLB 20015-0075		0.75				45	4	16,020	0.83	0.86	0.90	0.93	1.00		
HGLB 20015-010		1				45	4	16,020	1.09	1.13	1.17	1.21	1.30		
HGLB 2002-003	RO.1	0.3	0.16	0.19	16°	45	4	8,640	0.42	0.44	0.46	0.48	0.52		
HGLB 2002-005		0.5				45	4	8,640	0.63	0.66	0.68	0.71	0.76		
HGLB 2002-0075		0.75				45	4	8,640	0.89	0.93	0.96	0.99	1.07		
HGLB 2002-010		1				45	4	8,640	1.15	1.20	1.24	1.28	1.37		
HGLB 2002-015		1.5				45	4	9,360	1.66	1.72	1.78	1.84	1.97		
HGLB 2002-020		2				45	4	10,440	2.18	2.25	2.33	2.41	2.58		
HGLB 2003-005		0.5				0.24	0.29	16°	45	4	8,520	0.63	0.65	0.68	0.70
HGLB 2003-0075	0.75	45	4	8,520	0.89				0.92	0.96	0.99	1.05			
HGLB 2003-010	1	45	4	8,520	1.15				1.19	1.23	1.27	1.36			
HGLB 2003-015	1.5	45	4	9,120	1.66				1.72	1.77	1.83	1.96			
HGLB 2003-020	2	45	4	9,120	2.18				2.25	2.32	2.40	2.57			
HGLB 2003-025	2.5	45	4	9,360	2.70				2.78	2.87	2.97	3.18			
HGLB 2003-030	3	45	4	9,360	3.21				3.32	3.42	3.54	3.80			
HGLB 2004-005	0.5	0.32	0.39	16°	45				4	5,880	0.63	0.65	0.67	0.70	0.74
HGLB 2004-0075	0.75				45				4	5,880	0.89	0.92	0.95	0.98	1.04
HGLB 2004-010	1				45				4	5,880	1.15	1.19	1.23	1.26	1.35
HGLB 2004-010-6	1				50	6	8,640	1.15	1.19	1.23	1.26	1.35			
HGLB 2004-0125	1.25				45	4	6,000	1.40	1.45	1.49	1.54	1.64			
HGLB 2004-015	1.5				45	4	6,000	1.66	1.71	1.77	1.82	1.95			
HGLB 2004-015-6	1.5				50	6	8,740	1.66	1.71	1.77	1.82	1.95			
HGLB 2004-020	2				45	4	6,120	2.18	2.25	2.32	2.39	2.56			
HGLB 2004-020-6	2				50	6	9,000	2.18	2.25	2.32	2.39	2.56			
HGLB 2004-025	2.5				45	4	6,360	2.70	2.78	2.87	2.96	3.17			
HGLB 2004-025-6	2.5				50	6	9,240	2.70	2.78	2.87	2.96	3.17			
HGLB 2004-030	3				45	4	6,720	3.21	3.31	3.42	3.53	3.79			
HGLB 2004-030-6	3				50	6	9,850	3.21	3.31	3.42	3.53	3.79			
HGLB 2004-035	3.5				45	4	7,320	3.73	3.84	3.97	4.10	4.40			
HGLB 2004-040	4				45	4	7,320	4.24	4.38	4.52	4.67	5.01			
HGLB 2005-010	1				0.4	0.49	16°	45	4	5,880	1.15	1.19	1.22	1.26	1.34
HGLB 2005-015	1.5							45	4	5,880	1.65	1.71	1.76	1.82	1.94
HGLB 2005-020	2	45	4	5,880				2.18	2.24	2.31	2.39	2.55			
HGLB 2005-025	2.5	45	4	5,880				2.69	2.78	2.86	2.96	3.16			
HGLB 2005-030	3	45	4	5,880				3.21	3.31	3.41	3.53	3.77			
HGLB 2005-035	3.5	45	4	5,880				3.73	3.84	3.96	4.09	4.39			
HGLB 2005-040	4	45	4	5,880				4.24	4.37	4.51	4.66	5.00			
HGLB 2005-045	4.5	45	4	6,000				4.76	4.91	5.06	5.23	5.61			
HGLB 2005-050	5	45	4	6,000				5.27	5.44	5.61	5.80	6.22			
HGLB 2005-060	6	45	4	6,120				6.30	6.50	6.71	6.94	7.45			

- $\phi 3\text{mm}$ Shank V Series
- UDC-PCD Series
- CBN Series
- Square
- Long Neck Square
- Radius
- Long Neck Radius
- Taper Neck Radius
- Ball / Long Shank Ball
- Long Neck Ball
- Taper Neck Ball
- Taper
- Barrel
- Spiral V Cutter
- Drill
- Technical Data

Unit (mm)

Model Number	Radius of Ball Nose R	Effective Length ℓ_1	Length of Cut ℓ	Neck Diameter ϕ_d	Shank Taper Angle Bia	Overall Length L	Shank Diameter ϕ_d	Suggested Retail Price ¥	Effective Length by Inclined Angles								
									30°	1°	1°30'	2°	3°				
HGLB 2006-010	R0.3	1	0.48	0.59	16°	45	4	5,040	1.14	1.18	1.22	1.25	1.33				
HGLB 2006-015		1.5				45	4	4,560	1.65	1.71	1.76	1.81	1.93				
HGLB 2006-015-6		1.5				50	6	6,890	1.65	1.71	1.76	1.81	1.93				
HGLB 2006-020		2				45	4	4,560	2.17	2.24	2.31	2.38	2.54				
HGLB 2006-020-6		2				50	6	6,960	2.17	2.24	2.31	2.38	2.54				
HGLB 2006-025		2.5				45	4	4,680	2.69	2.77	2.86	2.95	3.15				
HGLB 2006-025-6		2.5				50	6	6,890	2.69	2.77	2.86	2.95	3.15				
HGLB 2006-030		3				45	4	4,680	3.21	3.31	3.41	3.52	3.76				
HGLB 2006-030-6		3				50	6	7,080	3.21	3.31	3.41	3.52	3.76				
HGLB 2006-035		3.5				45	4	4,800	3.72	3.84	3.96	4.09	4.38				
HGLB 2006-040		4				45	4	4,800	4.24	4.37	4.51	4.66	4.99				
HGLB 2006-045		4.5				45	4	4,800	4.76	4.90	5.06	5.23	5.60				
HGLB 2006-050		5				45	4	4,800	5.27	5.44	5.61	5.80	6.21				
HGLB 2006-055		5.5				45	4	4,800	5.79	5.97	6.16	6.37	6.82				
HGLB 2006-060		6				45	4	4,800	6.30	6.50	6.71	6.93	7.43				
HGLB 2006-080		8				45	4	6,360	8.37	8.63	8.91	9.21	9.88				
HGLB 2006-100		10				45	4	6,480	10.43	10.76	11.11	11.49	12.33				
HGLB 2008-020		R0.4				2	0.64	0.79	16°	45	4	4,560	2.17	2.23	2.30	2.37	2.52
HGLB 2008-025						2.5				45	4	4,800	2.69	2.77	2.85	2.94	3.13
HGLB 2008-030						3				45	4	4,800	3.21	3.30	3.40	3.50	3.74
HGLB 2008-040	4		45	4	4,800	4.24				4.36	4.50	4.64	4.97				
HGLB 2008-050	5		45	4	4,800	5.27				5.43	5.60	5.78	6.19				
HGLB 2008-060	6		45	4	4,800	6.30				6.49	6.70	6.92	7.41				
HGLB 2008-070	7		45	4	4,800	7.33				7.56	7.80	8.06	8.64				
HGLB 2008-080	8		45	4	4,800	8.36				8.62	8.90	9.20	9.86				
HGLB 2010-020	R0.5		2	0.8	0.98	16°				45	4	3,840	2.18	2.24	2.30	2.36	2.51
HGLB 2010-020-6		2	50				6	6,120	2.18	2.24	2.30	2.36	2.51				
HGLB 2010-025		2.5	45				4	3,840	2.70	2.77	2.85	2.93	3.12				
HGLB 2010-030		3	45				4	3,840	3.21	3.30	3.40	3.50	3.73				
HGLB 2010-030-6		3	50				6	6,120	3.21	3.30	3.40	3.50	3.73				
HGLB 2010-040		4	45				4	4,320	4.24	4.37	4.50	4.64	4.96				
HGLB 2010-040-6		4	50				6	6,720	4.24	4.37	4.50	4.64	4.96				
HGLB 2010-050		5	45				4	4,320	5.28	5.43	5.60	5.78	6.18				
HGLB 2010-050-6		5	50				6	6,720	5.28	5.43	5.60	5.78	6.18				
HGLB 2010-060		6	45				4	4,680	6.31	6.50	6.70	6.92	7.40				
HGLB 2010-060-6		6	50				6	7,080	6.31	6.50	6.70	6.92	7.40				
HGLB 2010-070		7	45				4	4,680	7.34	7.56	7.80	8.06	8.63				
HGLB 2010-070-6		7	50				6	7,080	7.34	7.56	7.80	8.06	8.63				
HGLB 2010-080		8	45				4	4,680	8.37	8.63	8.90	9.20	9.85				
HGLB 2010-080-6		8	50				6	7,080	8.37	8.63	8.90	9.20	9.85				
HGLB 2010-100		10	45				4	4,680	10.43	10.76	11.10	11.47	12.30				
HGLB 2010-100-6		10	50				6	7,080	10.43	10.76	11.10	11.47	12.30				
HGLB 2010-120		12	45				4	4,680	12.50	12.89	13.30	13.75	14.75				
HGLB 2010-140		14	45				4	5,400	14.56	15.02	15.51	16.03	17.19				
HGLB 2010-160		16	50				4	6,360	16.62	17.15	17.71	18.31	19.64				

3mm Shank
V Series

UDC-PCD
Series

CBN
Series

Square

Long Neck
Square

Radius

Long Neck
Radius

Taper Neck
Radius

Ball / Long
Shank Ball

Long Neck
Ball

Taper Neck
Ball

Taper

Barrel

Spiral
V Cutter

Drill

Technical Data

2 Flutes HMGOAT for Hard Materials

Unit (mm)

Model Number	Radius of Ball Nose R	Effective Length ℓ_1	Length of Cut ℓ	Neck Diameter ϕd_1	Shank Taper Angle β	Overall Length L	Shank Diameter ϕd	Suggested Retail Price ¥	Effective Length by Inclined Angles								
									30°	1°	1°30'	2°	3°				
HGLB 2015-030	R0.75	3	1.2	1.47	16°	45	4	4,440	3.10	3.18	3.26	3.35	3.55				
HGLB 2015-030-6		3				50	6	7,130	3.10	3.18	3.26	3.35	3.55				
HGLB 2015-040		4				45	4	4,440	4.13	4.24	4.36	4.49	4.77				
HGLB 2015-060		6				45	4	4,440	6.19	6.37	6.56	6.76	7.22				
HGLB 2015-060-6		6				50	6	7,200	6.19	6.37	6.56	6.76	7.22				
HGLB 2015-080		8				45	4	4,680	8.25	8.50	8.76	9.04	9.67				
HGLB 2015-080-6		8				50	6	7,200	8.25	8.50	8.76	9.04	9.67				
HGLB 2015-100		10				45	4	5,040	10.32	10.63	10.96	11.32	12.11				
HGLB 2015-100-6		10				50	6	7,200	10.32	10.63	10.96	11.32	12.11				
HGLB 2015-120		12				45	4	5,400	12.38	12.76	13.16	13.60	14.56				
HGLB 2015-120-6		12				50	6	8,130	12.38	12.76	13.16	13.60	14.56				
HGLB 2015-140		14				45	4	5,400	14.44	14.89	15.36	15.87	17.01				
HGLB 2015-160		16				50	4	5,400	16.50	17.02	17.57	18.15	19.46				
HGLB 2015-200		20				60	4	5,400	20.63	21.28	21.97	22.71	24.35				
HGLB 2020-030	R1	3	1.6	1.98	16°	45	4	3,840	3.07	3.14	3.21	3.29	3.47				
HGLB 2020-030-6		3				50	6	6,120	3.07	3.14	3.21	3.29	3.47				
HGLB 2020-040		4				45	4	3,840	4.10	4.20	4.31	4.43	4.70				
HGLB 2020-040-6		4				50	6	6,120	4.10	4.20	4.31	4.43	4.70				
HGLB 2020-060		6				45	4	4,320	6.16	6.33	6.51	6.71	7.14				
HGLB 2020-060-6		6				50	6	6,600	6.16	6.33	6.51	6.71	7.14				
HGLB 2020-080		8				45	4	4,680	8.23	8.46	8.72	8.99	9.59				
HGLB 2020-080-6		8				50	6	7,080	8.23	8.46	8.72	8.99	9.59				
HGLB 2020-100		10				45	4	4,680	10.29	10.59	10.92	11.26	12.04				
HGLB 2020-100-6		10				50	6	7,080	10.29	10.59	10.92	11.26	12.04				
HGLB 2020-120		12				45	4	4,680	12.35	12.72	13.12	13.54	14.48				
HGLB 2020-120-6		12				50	6	7,080	12.35	12.72	13.12	13.54	14.48				
HGLB 2020-140		14				45	4	4,680	14.41	14.85	15.32	15.82	16.93				
HGLB 2020-160		16				45	4	4,680	16.48	16.98	17.52	18.10	19.38				
HGLB 2020-200		20				60	4	4,680	20.60	21.24	21.92	22.65	No Interference				
HGLB 2020-250		25				60	4	6,480	25.76	26.56	27.42	28.34	No Interference				
HGLB 2020-300		30				70	4	7,320	30.92	31.89	32.93	No Interference	No Interference				
HGLB 2030-060		R1.5				6	2.4	2.95	16°	60	6	4,680	6.20	6.35	6.52	6.69	7.09
HGLB 2030-080						8				60	6	4,680	8.26	8.48	8.72	8.97	9.54
HGLB 2030-100						10				60	6	5,400	10.32	10.61	10.92	11.25	11.99
HGLB 2030-120	12		60	6	5,640	12.38				12.74	13.12	13.53	14.43				
HGLB 2030-140	14		60	6	6,240	14.45				14.87	15.32	15.80	16.88				
HGLB 2030-160	16		60	6	6,240	16.51				17.00	17.52	18.08	19.33				
HGLB 2030-180	18		60	6	6,280	18.57				19.13	19.72	20.36	21.78				
HGLB 2030-200	20		70	6	6,000	20.64				21.26	21.92	22.64	24.22				
HGLB 2030-220	22		70	6	6,040	22.70				23.39	24.12	24.91	26.67				
HGLB 2030-250	25		70	6	6,000	25.79				26.58	27.43	28.33	30.34				
HGLB 2030-270	27		70	6	6,040	27.86				28.71	29.63	30.61	No Interference				
HGLB 2030-300	30		70	6	6,840	30.95				31.91	32.93	34.02	No Interference				

Unit (mm)

Model Number	Radius of Ball Nose R	Effective Length ℓ_1	Length of Cut ℓ	Neck Diameter ϕd_1	Shank Taper Angle Bia	Overall Length L	Shank Diameter ϕd	Suggested Retail Price ¥	Effective Length by Inclined Angles								
									30°	1°	1°30'	2°	3°				
HGLB 2040-080	R2	8	3.2	3.95	16°	70	6	4,800	8.24	8.45	8.67	8.90	9.43				
HGLB 2040-100		10				70	6	4,800	10.31	10.58	10.87	11.18	11.88				
HGLB 2040-120		12				70	6	6,240	12.37	12.71	13.07	13.46	14.32				
HGLB 2040-140		14				70	6	6,240	14.43	14.84	15.27	15.74	16.77				
HGLB 2040-160		16				70	6	6,240	16.49	16.97	17.47	18.01	19.22				
HGLB 2040-180		18				70	6	6,380	18.56	19.10	19.67	20.29	No Interference				
HGLB 2040-200		20				70	6	6,240	20.62	21.23	21.87	22.57	No Interference				
HGLB 2040-220		22				70	6	6,380	22.68	23.36	24.08	24.85	No Interference				
HGLB 2040-250		25				70	6	6,240	25.78	26.55	27.38	28.26	No Interference				
HGLB 2040-270		27				70	6	6,380	27.84	28.68	29.58	30.54	No Interference				
HGLB 2040-300		30				70	6	6,240	30.93	31.87	32.88	No Interference	No Interference				
HGLB 2040-350		35				80	6	7,200	36.09	37.20	38.38	No Interference	No Interference				
HGLB 2040-400		40				90	6	8,040	41.25	42.52	No Interference	No Interference	No Interference				
HGLB 2060-100		R3				10	4.8	5.95	—	80	6	7,800	No Interference	No Interference	No Interference	No Interference	No Interference
HGLB 2060-150						15				80	6	7,800	No Interference	No Interference	No Interference	No Interference	No Interference
HGLB 2060-180	18		80	6	7,890	No Interference				No Interference	No Interference	No Interference	No Interference				
HGLB 2060-200	20		80	6	7,800	No Interference				No Interference	No Interference	No Interference	No Interference				
HGLB 2060-250	25		80	6	7,800	No Interference				No Interference	No Interference	No Interference	No Interference				
HGLB 2060-300	30		80	6	8,040	No Interference				No Interference	No Interference	No Interference	No Interference				
HGLB 2060-350	35		80	6	8,040	No Interference				No Interference	No Interference	No Interference	No Interference				
HGLB 2060-400	40		90	6	8,760	No Interference				No Interference	No Interference	No Interference	No Interference				
HGLB 2060-500	50		120	6	9,480	No Interference				No Interference	No Interference	No Interference	No Interference				

∅3mm Shank
V Series

UDC-PCD
Series

CBN
Series

Square

Square

Long Neck
Square

Radius

Radius

Long Neck
Radius

Taper Neck
Radius

Ball

Ball / Long
Shank Ball

Long Neck
Ball

Taper Neck
Ball

Taper

Taper

Barrel

Barrel

Spiral
V Cutter

Spiral
V Cutter

Drill

Drill

Technical Data

Technical Data

Milling Conditions for HGLB

WORK MATERIAL			PREHARDENED STEELS HARDENED STEELS NAK / STAVAX (~55HRC)				HARDENED STEELS SKD11 (55~62HRC)				HARDENED STEELS HAP10 (62~66HRC)				HARDENED STEELS HAP72 (66~70HRC)			
Model Number	Radius of Ball Nose (mm)	Effective Length (mm)	Spindle Speed (min ⁻¹)	Feed Rate (mm/min)	a _p Axial Depth (mm)	a _e Radial Depth (mm)	Spindle Speed (min ⁻¹)	Feed Rate (mm/min)	a _p Axial Depth (mm)	a _e Radial Depth (mm)	Spindle Speed (min ⁻¹)	Feed Rate (mm/min)	a _p Axial Depth (mm)	a _e Radial Depth (mm)	Spindle Speed (min ⁻¹)	Feed Rate (mm/min)	a _p Axial Depth (mm)	a _e Radial Depth (mm)
2001-002	R0.05	0.2	48,000	200	0.005	0.01	48,000	200	0.005	0.01	48,000	150	0.003	0.006	40,000	120	0.002	0.004
2001-003		0.3	48,000	200	0.005	0.01	48,000	200	0.005	0.01	48,000	150	0.003	0.006	40,000	120	0.002	0.004
2001-005		0.5	48,000	200	0.005	0.01	48,000	200	0.005	0.01	48,000	150	0.003	0.006	40,000	120	0.002	0.004
20015-003	R0.075	0.3	48,000	230	0.007	0.014	48,000	230	0.007	0.014	48,000	170	0.005	0.01	40,000	135	0.003	0.006
20015-005		0.5	48,000	230	0.007	0.014	48,000	230	0.007	0.014	48,000	170	0.005	0.01	40,000	135	0.003	0.006
20015-0075		0.75	48,000	230	0.007	0.014	48,000	230	0.007	0.014	48,000	170	0.005	0.01	40,000	135	0.003	0.006
20015-010	R0.1	1	38,400	160	0.005	0.01	38,400	160	0.005	0.01	38,400	120	0.003	0.007	32,000	90	0.002	0.004
2002-003		0.3	44,000	250	0.01	0.03	42,000	250	0.01	0.03	40,000	200	0.008	0.024	36,000	150	0.006	0.018
2002-005		0.5	44,000	250	0.01	0.03	42,000	250	0.01	0.03	40,000	200	0.008	0.024	36,000	150	0.006	0.018
2002-0075		0.75	44,000	250	0.01	0.03	42,000	250	0.01	0.03	40,000	200	0.008	0.024	36,000	150	0.006	0.018
2002-010		1	44,000	250	0.01	0.03	42,000	250	0.01	0.03	40,000	200	0.008	0.024	36,000	150	0.006	0.018
2002-015		1.5	35,200	175	0.008	0.023	33,600	175	0.008	0.023	32,000	140	0.006	0.018	28,800	100	0.004	0.012
2002-020	2	35,200	120	0.003	0.008	33,600	100	0.003	0.008	32,000	90	0.003	0.008	28,800	70	0.002	0.006	
2003-005	R0.15	0.5	44,000	400	0.01	0.03	42,000	350	0.01	0.03	40,000	300	0.01	0.03	36,000	250	0.008	0.024
2003-0075		0.75	44,000	400	0.01	0.03	42,000	350	0.01	0.03	40,000	300	0.01	0.03	36,000	250	0.008	0.024
2003-010		1	44,000	400	0.01	0.03	42,000	350	0.01	0.03	40,000	300	0.01	0.03	36,000	250	0.008	0.024
2003-015		1.5	44,000	400	0.01	0.03	42,000	350	0.01	0.03	40,000	300	0.01	0.03	36,000	250	0.008	0.024
2003-020		2	35,200	280	0.008	0.023	33,600	245	0.008	0.023	32,000	210	0.008	0.023	28,800	175	0.006	0.018
2003-025		2.5	35,200	185	0.006	0.017	33,600	165	0.006	0.017	32,000	150	0.006	0.017	28,800	115	0.005	0.014
2003-030	3	35,200	140	0.004	0.01	33,600	125	0.004	0.01	32,000	110	0.004	0.01	28,800	85	0.003	0.009	
2004-005	R0.2	0.5	44,000	600	0.015	0.045	42,000	550	0.015	0.045	40,000	500	0.013	0.036	36,000	350	0.01	0.027
2004-0075		0.75	44,000	600	0.015	0.045	42,000	550	0.015	0.045	40,000	500	0.013	0.036	36,000	350	0.01	0.027
2004-010		1	44,000	600	0.015	0.045	42,000	550	0.015	0.045	40,000	500	0.013	0.036	36,000	350	0.01	0.027
2004-0125		1.25	44,000	600	0.015	0.045	42,000	550	0.015	0.045	40,000	500	0.013	0.036	36,000	350	0.01	0.027
2004-015		1.5	44,000	600	0.015	0.045	42,000	550	0.015	0.045	40,000	500	0.013	0.036	36,000	350	0.01	0.027
2004-020		2	44,000	600	0.015	0.045	42,000	550	0.015	0.045	40,000	500	0.013	0.036	36,000	350	0.01	0.027
2004-025		2.5	35,200	420	0.011	0.034	33,600	385	0.011	0.034	32,000	350	0.01	0.027	28,800	250	0.008	0.02
2004-030		3	35,200	330	0.008	0.024	33,600	310	0.008	0.024	32,000	280	0.008	0.022	28,000	200	0.006	0.016
2004-035		3.5	35,200	300	0.007	0.022	31,900	280	0.007	0.022	30,400	250	0.007	0.02	26,600	175	0.005	0.014
2004-040		4	35,200	270	0.006	0.019	30,240	250	0.006	0.019	28,800	220	0.006	0.018	25,200	150	0.004	0.012
2005-010	R0.25	1	44,000	900	0.02	0.065	40,000	800	0.015	0.05	36,000	600	0.015	0.05	30,000	400	0.015	0.03
2005-015		1.5	44,000	900	0.02	0.065	40,000	800	0.015	0.05	36,000	600	0.015	0.05	30,000	400	0.015	0.03
2005-020		2	44,000	900	0.02	0.065	40,000	800	0.015	0.05	36,000	600	0.015	0.05	30,000	400	0.015	0.03
2005-025		2.5	44,000	900	0.02	0.065	40,000	800	0.015	0.05	36,000	600	0.015	0.05	30,000	400	0.015	0.03
2005-030		3	32,700	450	0.01	0.04	31,500	400	0.01	0.03	30,000	300	0.008	0.03	24,000	200	0.007	0.015
2005-035		3.5	32,700	450	0.01	0.04	31,500	400	0.01	0.03	30,000	300	0.008	0.03	24,000	200	0.007	0.015
2005-040		4	32,700	450	0.01	0.04	31,500	400	0.01	0.03	30,000	300	0.008	0.03	24,000	200	0.007	0.015
2005-045		4.5	29,430	405	0.008	0.03	28,350	360	0.008	0.025	27,000	270	0.006	0.025	21,600	180	0.005	0.013
2005-050		5	26,160	360	0.005	0.02	25,200	320	0.005	0.02	24,000	240	0.004	0.02	19,200	160	0.003	0.01
2005-060		6	26,160	360	0.005	0.02	25,200	320	0.005	0.02	24,000	240	0.004	0.02	19,200	160	0.003	0.01

φ3mm Shank V Series

UDC-PCD Series

CBN Series

Square
Long Neck Square

Radius

Radius
Long Neck Radius
Taper Neck Radius

Ball / Long Shank Ball
Long Neck Ball

Taper Neck Ball

Taper

Barrel

Spiral V Cutter

Drill

Technical Data

Milling Conditions for HGLB

WORK MATERIAL		PREHARDENED STEELS HARDENED STEELS NAK / STAVAX (~55HRC)					HARDENED STEELS SKD11 (55~62HRC)				HARDENED STEELS HAP10 (62~66HRC)				HARDENED STEELS HAP72 (66~70HRC)				
Model Number	Radius of Ball Nose (mm)	Effective Length (mm)	Spindle Speed (min ⁻¹)	Feed Rate (mm/min)	a _p Axial Depth (mm)	a _e Radial Depth (mm)	Spindle Speed (min ⁻¹)	Feed Rate (mm/min)	a _p Axial Depth (mm)	a _e Radial Depth (mm)	Spindle Speed (min ⁻¹)	Feed Rate (mm/min)	a _p Axial Depth (mm)	a _e Radial Depth (mm)	Spindle Speed (min ⁻¹)	Feed Rate (mm/min)	a _p Axial Depth (mm)	a _e Radial Depth (mm)	
2006-010	R0.3	1	40,000	1,400	0.045	0.15	36,000	1,500	0.03	0.13	32,000	1,000	0.02	0.1	25,000	600	0.02	0.1	
2006-015		1.5	40,000	1,400	0.03	0.13	36,000	1,300	0.03	0.13	32,000	1,000	0.02	0.1	25,000	600	0.02	0.1	
2006-020		2	40,000	1,400	0.03	0.13	36,000	1,300	0.03	0.13	32,000	1,000	0.02	0.1	25,000	600	0.02	0.1	
2006-025		2.5	40,000	1,200	0.025	0.1	36,000	1,100	0.025	0.1	32,000	900	0.02	0.1	25,000	500	0.02	0.1	
2006-030		3	40,000	1,200	0.025	0.1	36,000	1,100	0.025	0.1	32,000	900	0.02	0.1	25,000	500	0.02	0.1	
2006-035		3.5	40,000	1,100	0.023	0.09	34,000	950	0.023	0.09	32,000	800	0.018	0.09	25,000	450	0.015	0.09	
2006-040		4	40,000	1,000	0.02	0.08	32,000	800	0.02	0.08	32,000	700	0.015	0.07	25,000	400	0.01	0.075	
2006-045		4.5	32,000	600	0.01	0.07	28,000	600	0.01	0.05	25,600	500	0.01	0.05	20,000	300	0.005	0.05	
2006-050		5	32,000	600	0.01	0.07	28,000	600	0.01	0.05	25,600	500	0.01	0.05	20,000	300	0.005	0.05	
2006-055		5.5	32,000	600	0.01	0.07	28,000	600	0.01	0.05	25,600	500	0.01	0.05	20,000	300	0.005	0.05	
2006-060		6	32,000	600	0.01	0.07	28,000	600	0.01	0.05	25,600	500	0.01	0.05	20,000	300	0.005	0.05	
2006-080		8	25,600	480	0.008	0.02	22,400	480	0.008	0.02	20,480	350	0.007	0.02	16,000	210	0.004	0.01	
2006-100		10	20,480	390	0.006	0.02	17,920	390	0.006	0.02	16,400	250	0.005	0.02	12,800	150	0.003	0.01	
2008-020		R0.4	2	35,000	1,600	0.06	0.21	30,000	1,600	0.04	0.17	26,000	1,350	0.04	0.15	20,000	700	0.02	0.12
2008-025			2.5	35,000	1,600	0.06	0.21	30,000	1,600	0.04	0.17	26,000	1,350	0.04	0.15	20,000	700	0.02	0.12
2008-030	3		35,000	1,600	0.06	0.21	30,000	1,600	0.04	0.17	26,000	1,350	0.04	0.15	20,000	700	0.02	0.12	
2008-040	4		35,000	1,600	0.06	0.21	30,000	1,600	0.04	0.17	26,000	1,350	0.04	0.15	20,000	700	0.02	0.12	
2008-050	5		31,500	1,300	0.04	0.17	27,500	1,300	0.03	0.15	23,400	1,000	0.03	0.11	18,000	530	0.015	0.09	
2008-060	6		28,000	1,000	0.02	0.12	25,000	1,000	0.02	0.12	20,800	675	0.02	0.075	16,000	350	0.01	0.06	
2008-070	7		25,200	900	0.02	0.11	22,500	900	0.02	0.11	18,700	600	0.018	0.068	14,400	330	0.009	0.05	
2008-080	8		22,400	800	0.02	0.1	20,000	800	0.02	0.1	16,640	540	0.016	0.06	12,800	300	0.008	0.048	
2010-020	R0.5		2	30,000	1,750	0.2	0.4	24,000	2,000	0.1	0.3	21,000	1,750	0.05	0.2	16,000	875	0.05	0.2
2010-025			2.5	30,000	1,750	0.2	0.4	24,000	2,000	0.1	0.3	21,000	1,750	0.05	0.2	16,000	875	0.05	0.2
2010-030		3	30,000	1,750	0.1	0.3	24,000	2,000	0.1	0.2	21,000	1,750	0.03	0.17	16,000	875	0.03	0.17	
2010-040		4	30,000	1,750	0.1	0.3	24,000	2,000	0.1	0.2	21,000	1,750	0.03	0.17	16,000	875	0.03	0.17	
2010-050		5	30,000	1,750	0.1	0.3	24,000	2,000	0.1	0.2	21,000	1,750	0.03	0.17	16,000	875	0.03	0.17	
2010-060		6	30,000	1,150	0.06	0.23	21,500	1,250	0.03	0.17	19,700	1,050	0.025	0.15	14,500	525	0.025	0.15	
2010-070		7	27,000	980	0.04	0.19	20,000	920	0.02	0.15	19,000	770	0.02	0.14	14,200	380	0.02	0.14	
2010-080		8	24,000	800	0.025	0.155	18,500	580	0.015	0.12	18,400	480	0.015	0.12	13,800	240	0.015	0.12	
2010-100		10	22,000	600	0.018	0.13	14,800	430	0.01	0.09	14,700	360	0.01	0.09	14,700	360	0.01	0.09	
2010-120		12	14,150	320	0.015	0.12	13,400	380	0.008	0.08	13,300	290	0.008	0.08	13,300	290	0.008	0.08	
2010-140		14	13,500	280	0.012	0.1	12,000	350	0.007	0.08	12,000	220	0.007	0.08	12,000	220	0.007	0.08	
2010-160		16	12,150	250	0.011	0.09	10,800	320	0.006	0.07	10,800	200	0.006	0.07	10,800	200	0.006	0.07	
2015-030		R0.75	3	30,000	2,450	0.25	0.55	17,000	2,000	0.12	0.4	15,000	1,750	0.06	0.29	11,250	875	0.06	0.29
2015-040			4	30,000	2,450	0.25	0.55	17,000	2,000	0.12	0.4	15,000	1,750	0.06	0.29	11,250	875	0.06	0.29
2015-060	6		30,000	2,450	0.15	0.45	17,000	2,000	0.07	0.31	15,000	1,750	0.04	0.24	11,250	875	0.04	0.24	
2015-080	8		23,500	1,300	0.1	0.37	15,000	1,250	0.045	0.25	14,000	1,050	0.03	0.21	10,500	525	0.03	0.21	
2015-100	10		23,500	1,300	0.1	0.37	15,000	1,250	0.045	0.25	14,000	1,050	0.03	0.21	10,500	525	0.03	0.21	
2015-120	12		13,100	480	0.03	0.21	13,000	580	0.02	0.17	13,000	480	0.02	0.17	9,750	240	0.02	0.17	
2015-140	14		11,200	400	0.025	0.19	10,900	490	0.015	0.145	10,900	390	0.015	0.145	8,200	190	0.015	0.145	
2015-160	16		10,000	360	0.023	0.17	9,800	440	0.014	0.13	9,800	350	0.014	0.13	7,380	170	0.014	0.13	
2015-200	20		8,900	320	0.02	0.15	8,700	390	0.012	0.12	8,700	310	0.012	0.12	6,560	150	0.012	0.12	

Ø3mm Shank
V SeriesUDC-PCD
SeriesCBN
Series

Square

Square
Long Neck
Square

Radius

Radius
Long Neck
RadiusTaper Neck
RadiusBall / Long
Shank BallBall
Long Neck
BallTaper Neck
Ball

Taper

Barrel

Spiral
V Cutter

Drill

Technical Data

Milling Conditions for HGLB

WORK MATERIAL			PREHARDENED STEELS HARDENED STEELS NAK / STAVAX (~55HRC)				HARDENED STEELS SKD11 (55~62HRC)				HARDENED STEELS HAP10 (62~66HRC)				HARDENED STEELS HAP72 (66~70HRC)			
Model Number	Radius of Ball Nose (mm)	Effective Length (mm)	Spindle Speed (min ⁻¹)	Feed Rate (mm/min)	a _p Axial Depth (mm)	a _e Radial Depth (mm)	Spindle Speed (min ⁻¹)	Feed Rate (mm/min)	a _p Axial Depth (mm)	a _e Radial Depth (mm)	Spindle Speed (min ⁻¹)	Feed Rate (mm/min)	a _p Axial Depth (mm)	a _e Radial Depth (mm)	Spindle Speed (min ⁻¹)	Feed Rate (mm/min)	a _p Axial Depth (mm)	a _e Radial Depth (mm)
2020-030	R1	3	28,000	2,900	0.3	0.7	14,000	2,100	0.15	0.5	14,700	2,100	0.15	0.35	12,250	1,800	0.08	0.35
2020-040		4	28,000	2,900	0.3	0.7	14,000	2,100	0.15	0.5	14,700	2,100	0.15	0.35	12,250	1,800	0.08	0.35
2020-060		6	28,000	2,900	0.2	0.6	14,000	2,100	0.1	0.4	14,700	2,100	0.15	0.3	12,250	1,800	0.06	0.3
2020-080		8	28,000	2,900	0.2	0.6	14,000	2,100	0.1	0.4	14,700	2,100	0.15	0.3	12,250	1,800	0.06	0.3
2020-100		10	28,000	2,900	0.2	0.6	14,000	2,100	0.1	0.4	14,700	2,100	0.15	0.3	12,250	1,800	0.06	0.3
2020-120		12	19,500	1,350	0.12	0.45	12,400	1,350	0.06	0.34	13,800	1,320	0.09	0.27	11,500	1,100	0.045	0.27
2020-140		14	19,500	1,350	0.12	0.45	12,400	1,350	0.06	0.34	13,800	1,320	0.09	0.27	11,500	1,100	0.045	0.27
2020-160		16	10,800	500	0.05	0.3	10,800	600	0.03	0.24	12,840	588	0.06	0.24	10,700	490	0.03	0.24
2020-200		20	10,800	500	0.035	0.25	10,800	450	0.02	0.19	10,270	440	0.04	0.19	8,560	370	0.02	0.19
2020-250		25	9,720	450	0.032	0.23	9,720	410	0.018	0.17	9,250	400	0.036	0.17	7,700	330	0.018	0.17
2020-300		30	8,650	400	0.028	0.2	8,650	360	0.016	0.15	8,200	350	0.032	0.15	6,850	300	0.016	0.15
2030-060		6	21,000	3,000	0.4	1	13,250	2,500	0.24	0.55	11,040	2,280	0.24	0.55	9,200	1,900	0.12	0.55
2030-080		8	21,000	3,000	0.4	1	13,250	2,500	0.24	0.55	11,040	2,280	0.24	0.55	9,200	1,900	0.12	0.55
2030-100	10	21,000	3,000	0.3	0.9	12,200	2,300	0.2	0.5	11,040	2,280	0.2	0.5	9,200	1,900	0.1	0.5	
2030-120	12	21,000	3,000	0.3	0.9	12,200	2,300	0.2	0.5	11,040	2,280	0.2	0.5	9,200	1,900	0.1	0.5	
2030-140	14	21,000	3,000	0.3	0.9	12,200	2,300	0.2	0.5	11,040	2,280	0.2	0.5	9,200	1,900	0.1	0.5	
2030-160	16	21,000	3,000	0.3	0.9	12,200	2,300	0.2	0.5	11,040	2,280	0.2	0.5	9,200	1,900	0.1	0.5	
2030-180	18	17,750	2,300	0.24	0.8	11,750	1,850	0.18	0.48	10,680	1,830	0.18	0.48	8,900	1,525	0.088	0.48	
2030-200	20	14,500	1,600	0.18	0.7	11,350	1,400	0.15	0.45	10,320	1,380	0.15	0.45	8,600	1,150	0.075	0.45	
2030-220	22	13,000	1,440	0.16	0.63	11,000	1,020	0.13	0.42	9,960	1,000	0.13	0.42	8,300	830	0.063	0.42	
2030-250	25	11,600	1,280	0.14	0.56	10,500	620	0.1	0.38	9,600	610	0.1	0.38	8,000	510	0.05	0.38	
2030-270	27	10,500	1,150	0.13	0.51	9,000	540	0.08	0.34	8,200	530	0.08	0.34	6,850	440	0.04	0.34	
2030-300	30	9,280	1,020	0.11	0.45	7,500	450	0.06	0.29	6,840	440	0.06	0.29	5,700	370	0.03	0.29	
2040-080	8	18,000	3,200	0.5	1.3	11,380	2,880	0.36	0.95	9,480	2,400	0.3	0.75	7,900	2,000	0.15	0.75	
2040-100	10	18,000	3,200	0.5	1.3	11,380	2,880	0.36	0.95	9,480	2,400	0.3	0.75	7,900	2,000	0.15	0.75	
2040-120	12	18,000	3,200	0.4	1.2	11,380	2,880	0.31	0.85	9,480	2,400	0.26	0.7	7,900	2,000	0.13	0.7	
2040-140	14	18,000	3,200	0.4	1.2	11,380	2,880	0.31	0.85	9,480	2,400	0.26	0.7	7,900	2,000	0.13	0.7	
2040-160	16	18,000	3,200	0.4	1.2	11,380	2,880	0.31	0.85	9,480	2,400	0.26	0.7	7,900	2,000	0.13	0.7	
2040-180	18	18,000	3,200	0.4	1.2	11,380	2,880	0.31	0.85	9,480	2,400	0.26	0.7	7,900	2,000	0.13	0.7	
2040-200	20	18,000	3,200	0.4	1.2	10,730	1,800	0.21	0.7	8,940	1,500	0.18	0.55	7,450	1,250	0.09	0.55	
2040-220	22	15,250	2,250	0.33	1.1	10,730	1,800	0.21	0.7	8,940	1,500	0.18	0.55	7,450	1,250	0.09	0.55	
2040-250	25	12,500	1,250	0.25	0.95	10,730	1,800	0.21	0.7	8,940	1,500	0.18	0.55	7,450	1,250	0.09	0.55	
2040-270	27	11,500	1,150	0.23	0.9	10,400	1,250	0.18	0.58	8,670	1,050	0.15	0.5	7,250	890	0.075	0.5	
2040-300	30	10,630	1,000	0.2	0.76	10,080	780	0.15	0.45	8,400	650	0.12	0.45	7,000	540	0.06	0.45	
2040-350	35	9,030	800	0.16	0.61	8,640	730	0.13	0.43	7,200	610	0.11	0.43	6,000	510	0.055	0.43	
2040-400	40	8,300	700	0.14	0.54	8,000	700	0.12	0.42	6,650	590	0.11	0.42	5,500	500	0.05	0.42	
2060-100	10	14,400	3,200	0.5	1.5	9,140	2,880	0.38	1.05	7,620	2,400	0.32	0.88	6,350	2,000	0.16	0.88	
2060-150	15	14,400	3,200	0.5	1.5	9,140	2,880	0.38	1.05	7,620	2,400	0.32	0.88	6,350	2,000	0.16	0.88	
2060-180	18	14,400	3,200	0.5	1.5	9,140	2,880	0.38	1.05	7,620	2,400	0.32	0.88	6,350	2,000	0.16	0.88	
2060-200	20	14,400	3,200	0.5	1.5	9,000	2,300	0.32	0.95	7,620	2,400	0.32	0.88	6,350	2,000	0.16	0.88	
2060-250	25	14,400	3,200	0.5	1.5	8,100	2,000	0.3	0.95	7,500	1,920	0.27	0.805	6,250	1,600	0.135	0.805	
2060-300	30	14,400	3,200	0.5	1.5	7,700	1,800	0.26	0.88	7,440	1,500	0.22	0.73	6,200	1,250	0.11	0.73	
2060-350	35	9,200	2,050	0.32	1	6,200	1,450	0.21	0.71	6,000	1,200	0.18	0.59	5,000	1,000	0.09	0.59	
2060-400	40	7,000	1,050	0.2	0.8	5,600	1,000	0.19	0.64	4,800	950	0.14	0.47	4,000	810	0.07	0.47	
2060-500	50	5,600	850	0.16	0.6	4,500	810	0.15	0.52	3,900	780	0.12	0.38	3,200	650	0.06	0.38	

- φ3mm Shank V Series
- UDC-PCD Series
- CBN Series
- Square
- Long Neck Square
- Radius
- Long Neck Radius
- Taper Neck Radius
- Ball / Long Shank Ball
- Long Neck Ball
- Taper Neck Ball
- Taper
- Barrel
- Spiral V Cutter
- Drill
- Technical Data

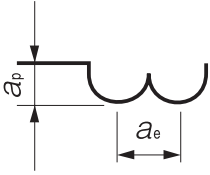

- Note:
- Decrease the feed rate more than 50% from the milling parameters when slot milling.
 - Decrease both spindle speed and feed rate proportionally when the milling parameters exceed the machines maximum speed, or when the tool is chattering and heats up to a red color.
 - Every coolant offers stable milling.

Wear Comparison HGLB R1 × EL6

HAP72 (69HRC)

Tools after milling

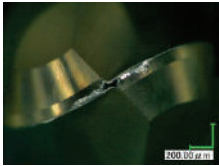

Conventional

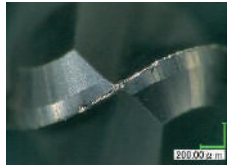

HGLB

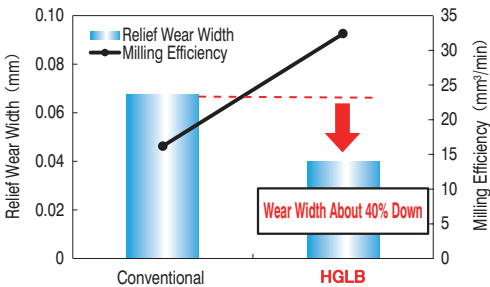

HGLB mills twice as efficiently as the conventional tool.

Tool	Conventional	HGLB 2020-060
Spindle Speed	9,200 min ⁻¹	12,250 min ⁻¹
Feed Rate	900 mm/min	1,800 mm/min
a_p	0.06 mm	
a_e	0.3 mm	
Coolant	Air Blow (Through Spindle)	
Milling Shape	Square Pocket (20 x 15 x Depth 2 mm) × 2 Pockets	
Cycle Time	76 min	50 min

$$\text{Milling Efficiency (mm}^3/\text{min)} = \text{Feed Rate} \times a_p \times a_e$$

Ø3mm Shank
V Series

UDC-PCD
Series

CBN
Series

Square

Long Neck
Square

Radius

Long Neck
Radius

Taper Neck
Radius

Ball / Long
Shank Ball

Long Neck
Ball

Taper Neck
Ball

Taper

Barrel

Spiral
V Cutter

Drill

Technical Data



Size R0.25~R1

HWLB

Super MG

HMW COAT

30°

R ±0.003

Shank Dia 0/-0.004

Back Taper Geometry

NEW

Back taper geometry does not apply to R0.45 or below, and $\ell_1 / D \leq 10$.

Material Applications (★ Highly Recommended ● Recommended ○ Suggested)

Work Material																	
Carbon Steels S45C S55C	Alloy Steels SK / SCM SUS	Prehardened Steels NAK HPM	Hardened Steels					Cast Iron	Aluminum Alloys	Graphite	Copper	Plastics	Glass Filled Plastics	Titanium Alloys	Heat Resistant Alloys	Cemented Carbide	Hard Brittle (Non-Metallic) Materials
			~50HRC	~55HRC	~60HRC	~65HRC	~70HRC										
○	○	●	★	★	★	●	●	○			○			○	○		

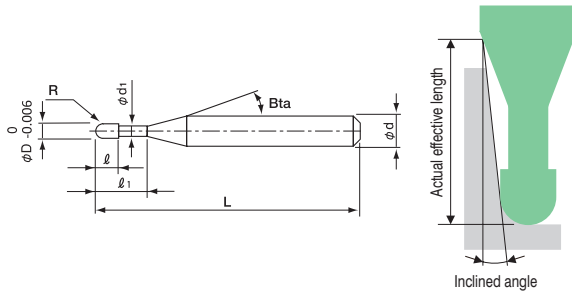

The shank taper angle shown is not an exact value and to avoid contact with the workpiece, we recommend the user controls the precise value of this angle. Shank taper angle should not make contact with the work piece.

◆ Variable rake angle design

Optimized rake angles are designed from the ball tip to the peripheral cutting edge.

Tip point

Negative rake angle design prevents fracture and chipping.

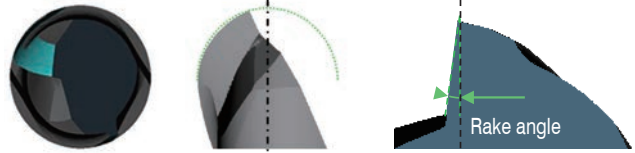

Peripheral cutting edge

Slightly negative rake angle design reduces cutting resistance and prevents chattering.

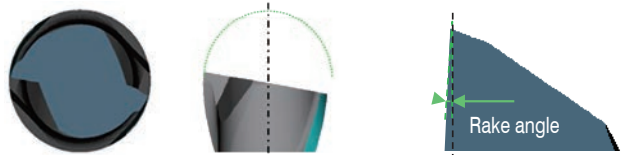

◆ High Accuracy

Even higher accuracy than our conventional tools!

Unit (mm)

Radius of Ball Nose	Diameter Tolerance	Ball Radius Accuracy	Shank Diameter Tolerance
R0.25 ~ R1	0/-0.006	± 0.003	0/-0.004 (h4)

- φ3mm Shank V Series
- UDC-PCD Series
- CBN Series
- Square
- Long Neck Square
- Radius
- Long Neck Radius
- Taper Neck Radius
- Ball / Long Shank Ball
- Long Neck Ball
- Taper Neck Ball
- Taper
- Barrel
- Spiral V Cutter
- Drill
- Technical Data

New coating HMWCOAT

New coating that is best suited for around 60HRC.

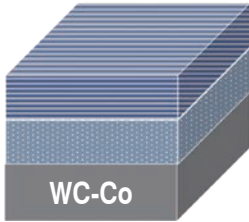

Ultra-high hardness layer

Nano-laminated structure prevents peeling and cracking on high hardness layer.

Shock absorption layer

Nanocomposite structure offers both hardness and toughness.

Toughness

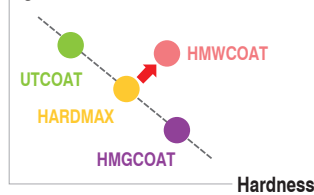

Higher hardness and toughness than conventional coating

Improved wear resistance compared to HARDMAX coating for milling around 60HRC.

How to find the best coating for your steel applications

Coating series	COPPER	CARBON STEELS	PREHARDENED STEELS	HARDENED STEELS				
				~ 50 HRC	~ 55 HRC	~ 60 HRC	~ 65 HRC	~ 70 HRC
HMG COAT HMGCOAT Best suited for milling high speed steel materials of 65HRC or above.			○	○	○	●	★	★
HMW COAT HMWCOAT Improved wear resistance compared to HARDMAX coating for around 60HRC.	○	○	●	●	●	★	●	●
HARD MAX HARDMAX Best suited for Prehardened Steels to Hardened Steels of 60HRC. Popular multi-purpose coating.	○	○	●	●	●	●	○	
UT COAT UTCOAT High lubricity and toughness. Suited for a wide range of materials including raw materials and SUS.	●	●	●	●	○			

How to find the best long neck ball series for your steel applications

Series	Features	Ball tip design	COPPER	CARBON STEELS	PREHARDENED STEELS	HARDENED STEELS				
						~ 50 HRC	~ 55 HRC	~ 60 HRC	~ 65 HRC	~ 70 HRC
HGLB	Best suited for Hard Materials	Super Negative			○	●	●	●	★	★
HWLB	For Hard Materials	Negative	○	○	●	★	★	★	●	●
HSLB HSLB-S	For Hard Materials Multi-purpose	Negative	○	○	●	●	●	●	○	
HLB	Multi-purpose	Positive	●	○	●	●	●	○		
CSELB	Multi-purpose Excellent surface quality	Standard	●	●	●	●	●			

Total 43 models

Unit (mm)

Model Number	Radius of Ball Nose R	Effective Length ℓ_1	Length of Cut ℓ	Neck Diameter ϕd_1	Shank Taper Angle β	Overall Length L	Shank Diameter ϕd	Suggested Retail Price ¥	Effective Length by Inclined Angles				
									30°	1°	1°30'	2°	3°
HWLB 2005-010	RO.25	1	0.4	0.49	16°	45	4	4,380	1.15	1.19	1.22	1.26	1.34
HWLB 2005-015		1.5							1.65	1.71	1.76	1.82	1.94
HWLB 2005-020		2							2.18	2.24	2.31	2.39	2.55
HWLB 2005-030		3							3.21	3.31	3.41	3.53	3.77
HWLB 2005-040		4							4.24	4.37	4.51	4.66	5.00
HWLB 2006-010	RO.3	1	0.48	0.59	16°	45	4	3,740	1.14	1.18	1.22	1.25	1.33
HWLB 2006-015		1.5							1.65	1.71	1.76	1.81	1.93
HWLB 2006-020		2							2.17	2.24	2.31	2.38	2.54
HWLB 2006-025		2.5							2.69	2.77	2.86	2.95	3.15
HWLB 2006-030		3							3.21	3.31	3.41	3.52	3.76
HWLB 2006-040		4							4.24	4.37	4.51	4.66	4.99
HWLB 2006-050		5							5.27	5.44	5.61	5.80	6.21
HWLB 2006-060		6							6.30	6.50	6.71	6.93	7.43
HWLB 2006-080		8							8.37	8.63	8.91	9.21	9.88
HWLB 2006-100		10							10.43	10.76	11.11	11.49	12.33
HWLB 2008-020	RO.4	2	0.64	0.79	16°	45	4	3,380	2.17	2.23	2.30	2.37	2.52
HWLB 2008-030		3							3.21	3.30	3.40	3.50	3.74
HWLB 2008-040		4							4.24	4.36	4.50	4.64	4.97
HWLB 2008-060		6							6.30	6.49	6.70	6.92	7.41
HWLB 2008-080		8							8.36	8.62	8.90	9.20	9.86
HWLB 2010-020	RO.5	2	0.8	0.98	16°	45	4	2,820	2.18	2.24	2.30	2.36	2.51
HWLB 2010-025		2.5							2.70	2.77	2.85	2.93	3.12
HWLB 2010-030		3							3.21	3.30	3.40	3.50	3.73
HWLB 2010-040		4							4.24	4.37	4.50	4.64	4.96
HWLB 2010-050		5							5.28	5.43	5.60	5.78	6.18
HWLB 2010-060		6							6.31	6.50	6.70	6.92	7.40
HWLB 2010-080		8							8.37	8.63	8.90	9.20	9.85
HWLB 2010-100		10							10.43	10.76	11.10	11.47	12.30
HWLB 2010-120		12							12.50	12.89	13.30	13.75	14.75
HWLB 2015-030		RO.75							3	1.2	1.47	16°	45
HWLB 2015-040	4		4.13	4.24	4.36	4.49	4.77						
HWLB 2015-060	6		6.19	6.37	6.56	6.76	7.22						
HWLB 2015-080	8		8.25	8.50	8.76	9.04	9.67						
HWLB 2015-100	10		10.32	10.63	10.96	11.32	12.11						
HWLB 2020-030	R1	3	1.6	1.98	16°	45	4	2,820	3.07	3.14	3.21	3.29	3.47
HWLB 2020-040		4							4.10	4.21	4.32	4.43	4.70
HWLB 2020-060		6							6.17	6.33	6.52	6.71	7.14
HWLB 2020-080		8							8.23	8.46	8.72	8.99	9.59
HWLB 2020-100		10							10.29	10.59	10.92	11.27	12.04
HWLB 2020-120		12							12.35	12.72	13.12	13.54	14.49
HWLB 2020-140		14							14.42	14.85	15.32	15.82	16.93
HWLB 2020-160		16							16.48	16.98	17.52	18.10	19.38
HWLB 2020-200		20							20.60	21.24	21.92	22.65	No Interference

- φ3mm Shank V Series
- UDC-PCD Series
- CBN Series
- Square
- Long Neck Square
- Radius
- Long Neck Radius
- Taper Neck Radius
- Ball / Long Shank Ball
- Long Neck Ball
- Taper Neck Ball
- Taper
- Barrel
- Spiral V Cutter
- Drill
- Technical Data

Milling example R0.5 × EL2

SKD11 (60HRC)

HWLB



Conventional tool



Spindle Speed	24,000 min ⁻¹
Feed Rate	2,000 mm/min
a_p	0.1 mm
a_e	0.3 mm
Coolant	Air Blow
Milling Shape	Square Pocket 118 × 16 × 0.9 mm
Cycle Time	32 min

HWLB shows little wear on the relief and face.

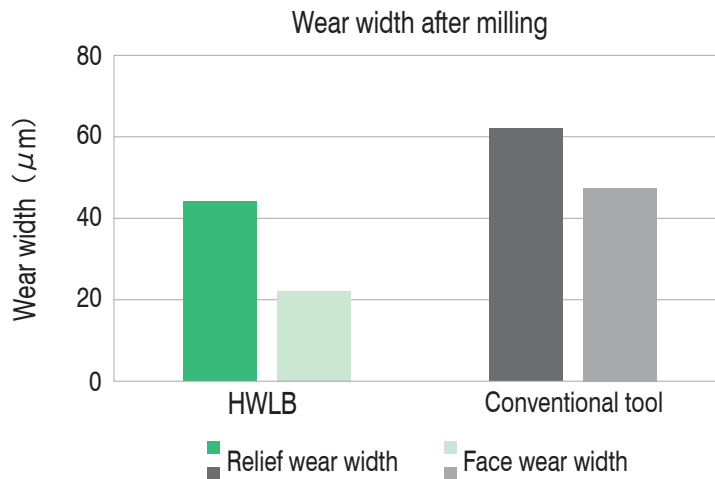

Ø3mm Shank
V Series

UDC-PCD
Series

CBN
Series

Square

Long Neck
Square

Radius

Long Neck
Radius

Taper Neck
Radius

Ball / Long
Shank Ball

Long Neck
Ball

Taper Neck
Ball

Taper

Barrel

Spiral
V Cutter

Drill

Technical Data

Milling Conditions for HWLB

WORK MATERIAL			PREHARDENED STEELS HARDENED STEELS NAK / STAVAX (~55HRC)				HARDENED STEELS SKD11 (55~62HRC)				HARDENED STEELS HAP10 (62~66HRC)				HARDENED STEELS HAP72 (66~70HRC)			
Model Number	Radius of Ball Nose (mm)	Effective Length (mm)	Spindle Speed (min ⁻¹)	Feed Rate (mm/min)	a _p Axial Depth (mm)	a _e Radial Depth (mm)	Spindle Speed (min ⁻¹)	Feed Rate (mm/min)	a _p Axial Depth (mm)	a _e Radial Depth (mm)	Spindle Speed (min ⁻¹)	Feed Rate (mm/min)	a _p Axial Depth (mm)	a _e Radial Depth (mm)	Spindle Speed (min ⁻¹)	Feed Rate (mm/min)	a _p Axial Depth (mm)	a _e Radial Depth (mm)
2005	R0.25	1	44,000	650	0.015	0.04	33,000	530	0.01	0.02	30,000	300	0.007	0.01	22,500	150	0.007	0.01
		1.5	44,000	650	0.015	0.04	33,000	530	0.01	0.02	30,000	300	0.007	0.01	22,500	150	0.007	0.01
		2	44,000	650	0.015	0.04	33,000	530	0.01	0.02	30,000	300	0.007	0.01	22,500	150	0.007	0.01
		3	40,000	500	0.01	0.02	31,000	400	0.007	0.01	28,550	230	0.005	0.008	21,400	115	0.005	0.008
		4	32,700	180	0.005	0.015	27,150	150	0.003	0.008	25,650	100	0.002	0.005	19,900	50	0.002	0.005
2006	R0.3	1	40,000	1,400	0.045	0.15	30,000	1,500	0.03	0.13	26,500	1,000	0.015	0.09	20,000	500	0.015	0.09
		1.5	40,000	1,100	0.03	0.13	30,000	1,200	0.02	0.1	26,500	800	0.01	0.075	20,000	400	0.01	0.075
		2	40,000	1,100	0.03	0.13	30,000	1,200	0.02	0.1	26,500	800	0.01	0.075	20,000	400	0.01	0.075
		2.5	40,000	800	0.02	0.1	30,000	800	0.015	0.09	26,500	520	0.008	0.065	20,000	260	0.008	0.065
		3	40,000	800	0.02	0.1	30,000	800	0.015	0.09	26,500	520	0.008	0.065	20,000	260	0.008	0.065
		4	40,000	500	0.015	0.09	30,000	500	0.01	0.075	26,500	340	0.006	0.05	20,000	170	0.006	0.05
		5	32,000	400	0.01	0.075	25,000	390	0.007	0.05	23,000	260	0.005	0.04	18,000	130	0.005	0.04
		6	24,000	300	0.007	0.06	21,000	320	0.005	0.04	19,500	210	0.004	0.03	15,000	105	0.004	0.03
		8	16,000	200	0.005	0.05	16,000	240	0.003	0.02	16,000	160	0.003	0.02	12,000	80	0.003	0.02
		10	14,900	175	0.003	0.02	14,900	175	0.002	0.015	14,900	115	0.002	0.015	11,100	55	0.002	0.015
2008	R0.4	2	35,000	1,600	0.06	0.21	27,000	1,600	0.04	0.17	23,500	1,000	0.02	0.12	17,500	500	0.02	0.12
		3	35,000	1,400	0.05	0.19	27,000	1,400	0.03	0.15	23,500	900	0.015	0.1	17,500	450	0.015	0.1
		4	35,000	1,200	0.04	0.17	27,000	1,200	0.025	0.135	23,500	600	0.012	0.095	17,500	300	0.012	0.095
		6	28,000	600	0.02	0.12	23,000	600	0.012	0.095	20,500	400	0.006	0.065	15,500	200	0.006	0.065
		8	19,500	330	0.012	0.095	18,000	375	0.007	0.07	17,000	285	0.005	0.06	12,750	140	0.005	0.06
2010	R0.5	2	30,000	1,750	0.2	0.4	24,000	2,000	0.1	0.3	21,000	1,750	0.05	0.2	16,000	875	0.05	0.2
		2.5	30,000	1,750	0.2	0.4	24,000	2,000	0.1	0.3	21,000	1,750	0.05	0.2	16,000	875	0.05	0.2
		3	30,000	1,750	0.1	0.3	24,000	2,000	0.05	0.2	21,000	1,750	0.03	0.17	16,000	875	0.03	0.17
		4	30,000	1,750	0.1	0.3	24,000	2,000	0.05	0.2	21,000	1,750	0.03	0.17	16,000	875	0.03	0.17
		5	30,000	1,750	0.1	0.3	24,000	2,000	0.05	0.2	21,000	1,750	0.03	0.17	16,000	875	0.03	0.17
		6	30,000	1,150	0.06	0.23	21,500	1,250	0.03	0.17	19,700	1,050	0.025	0.15	14,500	525	0.025	0.15
		8	24,000	800	0.025	0.155	18,500	580	0.015	0.12	18,400	480	0.015	0.12	13,800	240	0.015	0.12
		10	22,000	600	0.018	0.13	14,800	430	0.01	0.09	14,700	360	0.01	0.09	11,100	180	0.01	0.09
		12	14,150	320	0.015	0.12	13,400	380	0.008	0.08	13,300	290	0.008	0.08	9,950	145	0.008	0.08
		2015	R0.75	3	30,000	2,450	0.25	0.55	17,000	2,000	0.12	0.4	15,000	1,750	0.06	0.29	11,250	875
4	30,000			2,450	0.25	0.55	17,000	2,000	0.12	0.4	15,000	1,750	0.06	0.29	11,250	875	0.06	0.29
6	30,000			2,450	0.15	0.45	17,000	2,000	0.07	0.31	15,000	1,750	0.04	0.24	11,250	875	0.04	0.24
8	23,500			1,300	0.1	0.37	15,000	1,250	0.045	0.25	14,000	1,050	0.03	0.21	10,500	525	0.03	0.21
10	23,500			1,300	0.1	0.37	15,000	1,250	0.045	0.25	14,000	1,050	0.03	0.21	10,500	525	0.03	0.21

- φ3mm Shank V Series
- UDC-PCD Series
- CBN Series
- Square
- Long Neck Square
- Radius
- Long Neck Radius
- Taper Neck Radius
- Ball / Long Shank Ball
- Long Neck Ball
- Taper Neck Ball
- Taper
- Barrel
- Spiral V Cutter
- Drill
- Technical Data

Milling Conditions for HWLB

WORK MATERIAL			PREHARDENED STEELS HARDENED STEELS NAK / STAVAX (~55HRC)				HARDENED STEELS SKD11 (55~62HRC)				HARDENED STEELS HAP10 (62~66HRC)				HARDENED STEELS HAP72 (66~70HRC)			
Model Number	Radius of Ball Nose (mm)	Effective Length (mm)	Spindle Speed (min ⁻¹)	Feed Rate (mm/min)	a_p Axial Depth (mm)	a_e Radial Depth (mm)	Spindle Speed (min ⁻¹)	Feed Rate (mm/min)	a_p Axial Depth (mm)	a_e Radial Depth (mm)	Spindle Speed (min ⁻¹)	Feed Rate (mm/min)	a_p Axial Depth (mm)	a_e Radial Depth (mm)	Spindle Speed (min ⁻¹)	Feed Rate (mm/min)	a_p Axial Depth (mm)	a_e Radial Depth (mm)
2020	R1	3	28,000	2,900	0.3	0.7	14,000	2,100	0.15	0.5	12,250	1,800	0.08	0.35	9,200	900	0.08	0.35
		4	28,000	2,900	0.3	0.7	14,000	2,100	0.15	0.5	12,250	1,800	0.08	0.35	9,200	900	0.08	0.35
		6	28,000	2,900	0.2	0.6	14,000	2,100	0.1	0.4	12,250	1,800	0.06	0.3	9,200	900	0.06	0.3
		8	28,000	2,900	0.2	0.6	14,000	2,100	0.1	0.4	12,250	1,800	0.06	0.3	9,200	900	0.06	0.3
		10	28,000	2,900	0.2	0.6	14,000	2,100	0.1	0.4	12,250	1,800	0.06	0.3	9,200	900	0.06	0.3
		12	19,500	1,350	0.12	0.45	12,400	1,350	0.06	0.34	11,500	1,100	0.045	0.27	8,650	550	0.045	0.27
		14	19,500	1,350	0.12	0.45	12,400	1,350	0.06	0.34	11,500	1,100	0.045	0.27	8,650	550	0.045	0.27
		16	10,800	500	0.05	0.3	10,800	600	0.03	0.24	10,700	490	0.03	0.24	8,000	245	0.03	0.24
		20	8,650	375	0.035	0.25	8,650	450	0.02	0.19	8,560	370	0.02	0.19	6,400	185	0.02	0.19

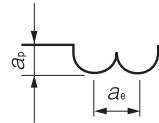

Note:

- Decrease the feed rate more than 50% from the milling parameters when slot milling.
- Decrease both spindle speed and feed rate proportionally when the milling parameters exceed the machine's maximum spindle speed, or when chattering and red-hot occur.
- Every coolant offers stable milling.

∅3mm Shank
V Series

UDC-PCD
Series

CBN
Series

Square

Long Neck
Square

Radius

Long Neck
Radius

Taper Neck
Radius

Ball / Long
Shank Ball

Long Neck
Ball

Taper Neck
Ball

Taper

Barrel

Spiral
V Cutter

Drill

Technical Data



Size R0.05~R3

HSLB

Super
MG

HARD
MAX

Shank Dia
0/-0.005

Back Taper
Geometry

Back taper geometry does not apply to R0.45 or below, and $\ell_1 / D \leq 10$.

Material Applications (★ Highly Recommended ● Recommended ○ Suggested)

Work Material																	
Carbon Steels S45C S55C	Alloy Steels SK / SCM SUS	Prehardened Steels NAK HPM	Hardened Steels					Cast Iron	Aluminum Alloys	Graphite	Copper	Plastics	Glass Filled Plastics	Titanium Alloys	Heat Resistant Alloys	Cemented Carbide	Hard Brittle (Non-Metallic) Materials
			~50HRC	~55HRC	~60HRC	~65HRC	~70HRC										
○	○	●	●	●	●	○	○				○			○	○		

φ3mm Shank
V Series

UDC-PCD
Series

CBN
Series

Square
Long Neck
Square

Radius

Long Neck
Radius

Taper Neck
Radius

Ball / Long
Shank Ball

Long Neck
Ball

Taper Neck
Ball

Taper

Barrel

Spiral
V Cutter

Drill

Technical Data

Features

- Variable rake angle design**
Optimized rake angles are designed from the ball tip to the peripheral cutting edge.
- HARDMAX coating**
HARDMAX coating offers heat resistance, durability and lubricity at a high level.
- Suitable for various coolant types.**
Every coolant offers stable milling.

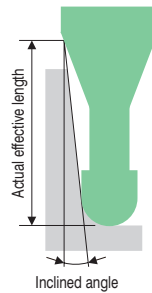
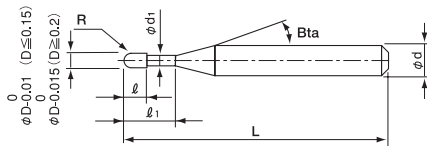
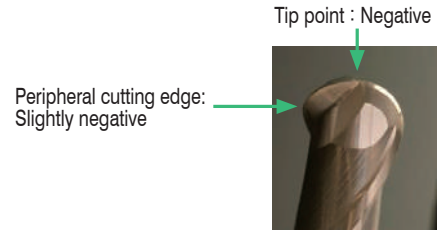

The shank taper angle shown is not an exact value and to avoid contact with the work piece, we recommend the user controls the precise value of this angle. Shank taper angle should not make contact with the work piece.

Radius of Ball Nose	Diameter Tolerance	Ball Radius Accuracy	Helix Angle
R0.05 ~ R0.075	0/-0.01	±0.002	0°
R0.1 ~ R3	0/-0.015	±0.005	30°

Long neck ball series for steels

Number of Flutes	Model Number	Features	Ball tip design	Copper	Carbon Steels	Pre hardened Steels	HARDENED STEELS					Alloy Steels	Aluminum Alloys	Plastics	Titanium/ Heat Resistant Alloys	Page
							~ 50 HRC	~ 55 HRC	~ 60 HRC	~ 65 HRC	~ 70 HRC					
2 Flutes	HGLB	Best suited for Hard Materials	Super Negative			○	●	●	●	★	★					460
	HWLB	For Hard Materials	Negative	○	○	●	★	★	★	●	●	○			○	470
	HSLB HSLB-S	For Hard Materials Multi-purpose	Negative	○	○	●	●	●	●	○		○			○	476 492
	CSELB	Multi-purpose Excellent surface quality	Standard	●	●	●	●	●				●	●		○	496
	CFLB	Multi-purpose Excellent surface quality	Positive	●	●	●	●	●				●	●	○	●	530

Total 325 models

Unit (mm)

Model Number	Radius of Ball Nose R	Effective Length l_1	Length of Cut l	Neck Diameter ϕd_1	Shank Taper Angle β	Overall Length L	Shank Diameter ϕd	Suggested Retail Price ¥	Effective Length by Inclined Angles								
									30°	1°	1°30'	2°	3°				
HSLB 2001-002	RO.05	0.2	0.08	0.095	11°	45	4	9,300	0.21	0.23	0.25	0.27	0.31				
HSLB 2001-003		0.3				45	4	9,300	0.32	0.35	0.37	0.40	0.45				
HSLB 2001-005		0.5				45	4	10,030	0.54	0.57	0.61	0.64	0.72				
HSLB 20015-003	RO.075	0.3	0.12	0.135	11°	45	4	10,760	0.36	0.38	0.40	0.42	0.47				
HSLB 20015-005		0.5				45	4	11,400	0.57	0.60	0.63	0.67	0.75				
HSLB 20015-010		1				45	4	11,860	1.10	1.15	1.21	1.27	1.43				
HSLB 2002-003	RO.1	0.3	0.16	0.19	16°	45	4	6,470	0.39	0.42	0.44	0.46	0.50				
HSLB 2002-005		0.5				45	4	6,470	0.61	0.64	0.66	0.69	0.74				
HSLB 2002-005-6		0.5				50	6	9,030	0.61	0.64	0.66	0.69	0.74				
HSLB 2002-0075		0.75				45	4	6,470	0.87	0.91	0.95	0.98	1.05				
HSLB 2002-010		1				45	4	6,470	1.13	1.18	1.22	1.26	1.35				
HSLB 2002-010-6		1				50	6	9,030	1.13	1.18	1.22	1.26	1.35				
HSLB 2002-0125		1.25				45	4	7,020	1.38	1.44	1.49	1.54	1.65				
HSLB 2002-015		1.5				45	4	7,020	1.64	1.71	1.76	1.82	1.96				
HSLB 2002-015-6		1.5				50	6	9,800	1.64	1.71	1.76	1.82	1.96				
HSLB 2002-0175		1.75				45	4	7,750	1.90	1.97	2.04	2.11	2.26				
HSLB 2002-020		2				45	4	7,750	2.16	2.24	2.31	2.39	2.57				
HSLB 2002-020-6		2				50	6	10,820	2.16	2.24	2.31	2.39	2.57				
HSLB 2002-0225		2.25				45	4	8,480	2.42	2.51	2.59	2.68	2.87				
HSLB 2002-025		2.5				45	4	8,480	2.68	2.77	2.86	2.96	3.18				
HSLB 2002-030		3				45	4	9,120	3.20	3.30	3.41	3.53	3.79				
HSLB 2003-005		RO.15				0.5	0.24	0.29	16°	45	4	6,380	0.60	0.63	0.66	0.68	0.73
HSLB 2003-006						0.6				45	4	6,380	0.71	0.74	0.77	0.80	0.85
HSLB 2003-0075						0.75				45	4	6,380	0.87	0.91	0.94	0.97	1.04
HSLB 2003-010						1				45	4	6,380	1.13	1.18	1.22	1.26	1.34
HSLB 2003-010-6						1				50	6	8,660	1.13	1.18	1.22	1.26	1.34
HSLB 2003-0125	1.25		45	4	6,840	1.38				1.43	1.48	1.53	1.64				
HSLB 2003-015	1.5		45	4	6,840	1.64				1.70	1.76	1.82	1.94				
HSLB 2003-015-6	1.5		50	6	9,490	1.64				1.70	1.76	1.82	1.94				
HSLB 2003-0175	1.75		45	4	6,840	1.90				1.97	2.03	2.10	2.25				
HSLB 2003-020	2		45	4	6,840	2.16				2.24	2.31	2.38	2.56				
HSLB 2003-020-6	2		50	6	9,490	2.16				2.24	2.31	2.38	2.56				
HSLB 2003-0225	2.25		45	4	7,020	2.42				2.50	2.58	2.67	2.86				
HSLB 2003-025	2.5		45	4	7,020	2.68				2.77	2.86	2.95	3.17				
HSLB 2003-030	3		45	4	7,020	3.20				3.30	3.41	3.52	3.78				
HSLB 2003-040	4		45	4	7,300	4.23				4.37	4.51	4.66	5.00				
HSLB 2003-050	5		45	4	8,210	5.26				5.43	5.61	5.80	6.23				

Next Page ➡

 3mm Shank V Series

 UDC-PCD Series

 CBN Series

 Square

 Long Neck Square

 Radius

 Long Neck Radius

 Taper Neck Radius

 Ball / Long Shank Ball

 Long Neck Ball

 Taper Neck Ball

 Taper

 Barrel

 Spiral V Cutter

 Drill

 Technical Data

Model Number	Radius of Ball Nose R	Effective Length l_1	Length of Cut l	Neck Diameter ϕd_1	Shank Taper Angle Bia	Overall Length L	Shank Diameter ϕd	Suggested Retail Price ¥	Effective Length by Inclined Angles				
									30°	1°	1°30'	2°	3°
HSLB 2004-005	RO.2	0.5	0.32	0.39	16°	45	4	4,380	0.60	0.63	0.65	0.68	0.72
HSLB 2004-0075		0.75				45	4	4,380	0.86	0.90	0.93	0.96	1.03
HSLB 2004-010		1				45	4	4,380	1.13	1.17	1.21	1.25	1.33
HSLB 2004-010-6		1				50	6	6,380	1.13	1.17	1.21	1.25	1.33
HSLB 2004-0125		1.25				45	4	4,470	1.37	1.43	1.48	1.52	1.63
HSLB 2004-015		1.5				45	4	4,470	1.64	1.70	1.75	1.81	1.93
HSLB 2004-015-6		1.5				50	6	6,470	1.64	1.70	1.75	1.81	1.93
HSLB 2004-0175		1.75				45	4	4,560	1.90	1.97	2.03	2.09	2.24
HSLB 2004-020		2				45	4	4,560	2.16	2.23	2.30	2.38	2.55
HSLB 2004-020-6		2				50	6	6,660	2.16	2.23	2.30	2.38	2.55
HSLB 2004-0225		2.25				45	4	4,740	2.42	2.50	2.58	2.66	2.85
HSLB 2004-025		2.5				45	4	4,740	2.68	2.76	2.85	2.95	3.16
HSLB 2004-025-6		2.5				50	6	6,840	2.68	2.76	2.85	2.95	3.16
HSLB 2004-030		3				45	4	5,020	3.20	3.30	3.40	3.52	3.77
HSLB 2004-030-6		3				50	6	7,300	3.20	3.30	3.40	3.52	3.77
HSLB 2004-035		3.5				45	4	5,470	3.71	3.83	3.95	4.09	4.38
HSLB 2004-040		4				45	4	5,470	4.23	4.36	4.50	4.66	4.99
HSLB 2004-040-6		4				50	6	7,440	4.23	4.36	4.50	4.66	4.99
HSLB 2004-045		4.5				45	4	5,740	4.74	4.89	5.05	5.22	5.61
HSLB 2004-050		5				45	4	5,740	5.26	5.43	5.60	5.79	6.22
HSLB 2004-060	6	45	4	6,660	6.29	6.49	6.70	6.93	7.44				
HSLB 2005-010	RO.25	1	0.4	0.49	16°	45	4	4,380	1.12	1.17	1.21	1.24	1.32
HSLB 2005-0125		1.25				45	4	4,380	1.37	1.43	1.47	1.52	1.62
HSLB 2005-015		1.5				45	4	4,380	1.63	1.70	1.75	1.80	1.92
HSLB 2005-015-6		1.5				50	6	6,380	1.63	1.70	1.75	1.80	1.92
HSLB 2005-0175		1.75				45	4	4,380	1.90	1.96	2.02	2.09	2.23
HSLB 2005-020		2				45	4	4,380	2.16	2.23	2.30	2.37	2.54
HSLB 2005-020-6		2				50	6	6,380	2.16	2.23	2.30	2.37	2.54
HSLB 2005-0225		2.25				45	4	4,380	2.42	2.50	2.57	2.66	2.84
HSLB 2005-025		2.5				45	4	4,380	2.68	2.76	2.85	2.94	3.15
HSLB 2005-025-6		2.5				50	6	6,380	2.68	2.76	2.85	2.94	3.15
HSLB 2005-030		3				45	4	4,380	3.20	3.29	3.40	3.51	3.76
HSLB 2005-030-6		3				50	6	6,380	3.20	3.29	3.40	3.51	3.76
HSLB 2005-035		3.5				45	4	4,380	3.71	3.83	3.95	4.08	4.37
HSLB 2005-040		4				45	4	4,380	4.23	4.36	4.50	4.65	4.98
HSLB 2005-040-6		4				50	6	6,380	4.23	4.36	4.50	4.65	4.98
HSLB 2005-045		4.5				45	4	4,470	4.74	4.89	5.05	5.22	5.59
HSLB 2005-050		5				45	4	4,470	5.26	5.42	5.60	5.79	6.21
HSLB 2005-055		5.5				45	4	4,560	5.77	5.96	6.15	6.36	6.82
HSLB 2005-060		6				45	4	4,560	6.29	6.49	6.70	6.93	7.43
HSLB 2005-070		7				45	4	5,470	7.32	7.55	7.80	8.06	8.65
HSLB 2005-080	8	45	4	5,470	8.35	8.62	8.90	9.20	9.88				
HSLB 2005-090	9	45	4	6,380	9.38	9.68	10.00	10.34	11.10				
HSLB 2005-100	10	50	4	6,800	10.42	10.75	11.10	11.48	12.32				

- $\phi 3\text{mm}$ Shank V Series
- UDC-PCD Series
- CBN Series
- Square
- Long Neck Square
- Radius
- Long Neck Radius
- Taper Neck Radius
- Ball / Long Shank Ball
- Long Neck Ball
- Taper Neck Ball
- Taper
- Barrel
- Spiral V Cutter
- Drill
- Technical Data

Unit (mm)

Model Number	Radius of Ball Nose R	Effective Length l_1	Length of Cut l	Neck Diameter ϕd_1	Shank Taper Angle Bta	Overall Length L	Shank Diameter ϕd	Suggested Retail Price ¥	Effective Length by Inclined Angles								
									30°	1°	1°30'	2°	3°				
HSLB 2006-010	R0.3	1	0.48	0.59	16°	45	4	3,740	1.12	1.16	1.20	1.24	1.31				
HSLB 2006-0125		1.25				45	4	3,380	1.37	1.42	1.47	1.51	1.61				
HSLB 2006-015		1.5				45	4	3,380	1.63	1.69	1.74	1.80	1.91				
HSLB 2006-015-6		1.5				50	6	5,100	1.63	1.69	1.74	1.80	1.91				
HSLB 2006-0175		1.75				45	4	3,380	1.89	1.96	2.02	2.08	2.22				
HSLB 2006-020		2				45	4	3,380	2.15	2.23	2.29	2.36	2.52				
HSLB 2006-020-6		2				50	6	5,100	2.15	2.23	2.29	2.36	2.52				
HSLB 2006-0225		2.25				45	4	3,460	2.42	2.49	2.57	2.65	2.83				
HSLB 2006-025		2.5				45	4	3,460	2.67	2.76	2.84	2.93	3.14				
HSLB 2006-025-6		2.5				50	6	5,100	2.67	2.76	2.84	2.93	3.14				
HSLB 2006-030		3				45	4	3,460	3.19	3.29	3.39	3.50	3.75				
HSLB 2006-030-6		3				50	6	5,200	3.19	3.29	3.39	3.50	3.75				
HSLB 2006-035		3.5				45	4	3,560	3.71	3.82	3.94	4.07	4.36				
HSLB 2006-040		4				45	4	3,560	4.23	4.36	4.49	4.64	4.97				
HSLB 2006-040-6		4				50	6	5,380	4.23	4.36	4.49	4.64	4.97				
HSLB 2006-045		4.5				45	4	3,560	4.74	4.89	5.04	5.21	5.58				
HSLB 2006-050		5				45	4	3,560	5.26	5.42	5.59	5.78	6.20				
HSLB 2006-050-6		5				50	6	5,380	5.26	5.42	5.59	5.78	6.20				
HSLB 2006-055		5.5				45	4	3,560	5.77	5.95	6.14	6.35	6.81				
HSLB 2006-060		6				45	4	3,560	6.29	6.49	6.69	6.92	7.42				
HSLB 2006-060-6		6				50	6	5,380	6.29	6.49	6.69	6.92	7.42				
HSLB 2006-065		6.5				45	4	4,020	6.80	7.02	7.25	7.49	8.03				
HSLB 2006-070		7				45	4	4,020	7.32	7.55	7.80	8.06	8.64				
HSLB 2006-080		8				45	4	4,740	8.35	8.61	8.90	9.20	9.87				
HSLB 2006-080-6		8				50	6	6,840	8.35	8.61	8.90	9.20	9.87				
HSLB 2006-090		9				45	4	5,020	9.38	9.68	10.00	10.34	11.09				
HSLB 2006-100		10				50	4	4,830	10.41	10.74	11.10	11.47	12.31				
HSLB 2006-100-6		10				50	6	7,300	10.41	10.74	11.10	11.47	12.31				
HSLB 2006-120		12				50	4	5,470	12.48	12.87	13.30	13.75	14.76				
HSLB 2007-020		R0.35				2	0.56	0.69	16°	45	4	3,380	2.15	2.22	2.29	2.36	2.51
HSLB 2007-040						4				45	4	3,560	4.22	4.35	4.49	4.63	4.96
HSLB 2007-060						6				45	4	3,560	6.29	6.48	6.69	6.91	7.41
HSLB 2007-080	8		45	4	3,560	8.35				8.61	8.89	9.19	9.86				
HSLB 2008-020	R0.4	2	0.64	0.79	16°	45	4	3,380	2.15	2.22	2.28	2.35	2.50				
HSLB 2008-020-6		2				50	6	5,100	2.15	2.22	2.28	2.35	2.50				
HSLB 2008-030		3				45	4	3,560	3.19	3.28	3.38	3.49	3.73				
HSLB 2008-030-6		3				50	6	5,380	3.19	3.28	3.38	3.49	3.73				
HSLB 2008-040		4				45	4	3,560	4.22	4.35	4.48	4.63	4.95				
HSLB 2008-040-6		4				50	6	5,380	4.22	4.35	4.48	4.63	4.95				
HSLB 2008-050		5				45	4	3,560	5.25	5.41	5.58	5.77	6.17				
HSLB 2008-060		6				45	4	3,560	6.29	6.48	6.68	6.91	7.40				
HSLB 2008-060-6		6				50	6	5,380	6.29	6.48	6.68	6.91	7.40				
HSLB 2008-070		7				45	4	3,560	7.32	7.54	7.79	8.04	8.62				
HSLB 2008-080		8				45	4	3,560	8.35	8.61	8.89	9.18	9.84				
HSLB 2008-080-6		8				50	6	5,380	8.35	8.61	8.89	9.18	9.84				
HSLB 2008-090		9				45	4	4,740	9.38	9.67	9.99	10.32	11.07				
HSLB 2008-100		10				50	4	4,740	10.41	10.74	11.09	11.46	12.29				
HSLB 2008-100-6		10				50	6	6,840	10.41	10.74	11.09	11.46	12.29				
HSLB 2008-120		12				50	4	5,840	12.47	12.87	13.29	13.74	14.74				
HSLB 2008-160		16				50	4	7,990	16.60	17.13	17.69	18.29	19.63				

Ø3mm Shank
V SeriesUDC-PCD
SeriesCBN
SeriesSquare
Long Neck
Square

Radius

Long Neck
RadiusTaper Neck
RadiusBall / Long
Shank BallLong Neck
BallTaper Neck
Ball

Taper

Barrel

Spiral
V Cutter

Drill

Technical Data

Model Number	Radius of Ball Nose R	Effective Length l_1	Length of Cut l	Neck Diameter ϕd_1	Shank Taper Angle Bia	Overall Length L	Shank Diameter ϕd	Suggested Retail Price ¥	Effective Length by Inclined Angles				
									30°	1°	1°30'	2°	3°
HSLB 2009-020	RO.45	2	0.72	0.89	16°	45	4	3,380	2.15	2.22	2.28	2.34	2.49
HSLB 2009-040		4				45	4	3,560	4.22	4.35	4.48	4.62	4.94
HSLB 2009-060		6				45	4	3,560	6.28	6.48	6.68	6.90	7.39
HSLB 2009-080		8				45	4	3,560	8.35	8.61	8.88	9.18	9.83
HSLB 2009-100		10				45	4	4,740	10.41	10.73	11.08	11.45	12.28
HSLB 2009-120		12				50	4	5,840	12.47	12.86	13.28	13.73	14.73
HSLB 2009-140		14				50	4	6,770	14.54	14.99	15.48	16.01	17.18
HSLB 2009-160		16				50	4	7,990	16.60	17.12	17.68	18.29	19.62
HSLB 2009-180		18				55	4	7,990	18.66	19.25	19.89	20.56	22.07
HSLB 2010-020	RO.5	2	0.8	0.98	16°	45	4	2,820	2.16	2.22	2.28	2.35	2.49
HSLB 2010-025		2.5				45	4	2,820	2.68	2.76	2.83	2.92	3.11
HSLB 2010-030		3				45	4	2,820	3.20	3.29	3.38	3.49	3.72
HSLB 2010-030-6		3				50	6	4,470	3.20	3.29	3.38	3.49	3.72
HSLB 2010-040		4				45	4	3,190	4.23	4.35	4.49	4.63	4.94
HSLB 2010-040-6		4				50	6	4,930	4.23	4.35	4.49	4.63	4.94
HSLB 2010-050		5				45	4	3,190	5.26	5.42	5.59	5.77	6.16
HSLB 2010-050-6		5				50	6	4,930	5.26	5.42	5.59	5.77	6.16
HSLB 2010-060		6				45	4	3,460	6.29	6.48	6.69	6.90	7.39
HSLB 2010-060-6		6				50	6	5,200	6.29	6.48	6.69	6.90	7.39
HSLB 2010-070		7				45	4	3,460	7.32	7.55	7.79	8.04	8.61
HSLB 2010-070-6		7				50	6	5,200	7.32	7.55	7.79	8.04	8.61
HSLB 2010-080		8				45	4	3,460	8.36	8.61	8.89	9.18	9.84
HSLB 2010-080-6		8				50	6	5,200	8.36	8.61	8.89	9.18	9.84
HSLB 2010-090		9				45	4	3,460	9.39	9.68	9.99	10.32	11.06
HSLB 2010-100		10				45	4	3,460	10.42	10.74	11.09	11.46	12.28
HSLB 2010-100-6		10				50	6	5,200	10.42	10.74	11.09	11.46	12.28
HSLB 2010-120		12				45	4	3,460	12.48	12.87	13.29	13.74	14.73
HSLB 2010-120-6		12				50	6	5,200	12.48	12.87	13.29	13.74	14.73
HSLB 2010-140		14				50	4	4,020	14.54	15.00	15.49	16.01	17.18
HSLB 2010-140-6		14				60	6	5,660	14.54	15.00	15.49	16.01	17.18
HSLB 2010-160		16				50	4	4,740	16.61	17.13	17.69	18.29	19.62
HSLB 2010-160-6	16	60	6	6,840	16.61	17.13	17.69	18.29	19.62				
HSLB 2010-180	18	55	4	4,740	18.67	19.26	19.89	20.57	22.07				
HSLB 2010-200	20	55	4	5,740	20.73	21.39	22.09	22.85	24.52				
HSLB 2010-200-6	20	70	6	8,120	20.73	21.39	22.09	22.85	24.52				
HSLB 2010-220-6	22	70	6	8,480	22.80	23.52	24.29	25.12	26.97				
HSLB 2012-025	RO.6	2.5	0.96	1.19	16°	45	4	4,290	2.54	2.60	2.67	2.74	2.91
HSLB 2012-040		4				45	4	4,290	4.08	4.20	4.32	4.45	4.75
HSLB 2012-060		6				45	4	4,650	6.15	6.33	6.52	6.73	7.19
HSLB 2012-060-6		6				50	6	6,620	6.15	6.33	6.52	6.73	7.19
HSLB 2012-080		8				45	4	4,650	8.21	8.46	8.72	9.01	9.64
HSLB 2012-080-6		8				50	6	6,620	8.21	8.46	8.72	9.01	9.64
HSLB 2012-100		10				45	4	4,650	10.27	10.59	10.92	11.28	12.09
HSLB 2012-100-6		10				50	6	6,620	10.27	10.59	10.92	11.28	12.09
HSLB 2012-120		12				45	4	4,650	12.33	12.72	13.12	13.56	14.54
HSLB 2012-120-6		12				50	6	6,620	12.33	12.72	13.12	13.56	14.54
HSLB 2012-140		14				50	4	5,020	14.40	14.85	15.33	15.84	16.98
HSLB 2012-160		16				50	4	5,470	16.46	16.98	17.53	18.12	19.43
HSLB 2012-160-6		16				60	6	7,530	16.46	16.98	17.53	18.12	19.43
HSLB 2012-180		18				55	4	5,930	18.52	19.11	19.73	20.39	21.88
HSLB 2012-200		20				60	4	5,930	20.58	21.23	21.93	22.67	24.33

- φ3mm Shank V Series
- UDC-PCD Series
- CBN Series
- Square
- Long Neck Square
- Radius
- Long Neck Radius
- Taper Neck Radius
- Ball / Long Shank Ball
- Long Neck Ball
- Taper Neck Ball
- Taper
- Barrel
- Spiral V Cutter
- Drill
- Technical Data

Unit (mm)

Model Number	Radius of Ball Nose R	Effective Length l_1	Length of Cut l	Neck Diameter ϕd_1	Shank Taper Angle β	Overall Length L	Shank Diameter ϕd	Suggested Retail Price ¥	Effective Length by Inclined Angles				
									30°	1°	1°30'	2°	3°
HSLB 2014-060	R0.7	6	1.12	1.37	16°	45	4	4,020	6.18	6.36	6.55	6.76	7.22
HSLB 2014-080		8				45	4	4,020	8.24	8.49	8.75	9.03	9.66
HSLB 2014-120		12				45	4	4,020	12.37	12.75	13.15	13.59	14.56
HSLB 2014-160		16				50	4	4,020	16.49	17.01	17.56	18.14	19.45
HSLB 2015-030	R0.75	3	1.2	1.47	16°	45	4	3,280	3.08	3.16	3.24	3.33	3.53
HSLB 2015-040		4				45	4	3,280	4.11	4.23	4.34	4.47	4.76
HSLB 2015-060		6				45	4	3,280	6.18	6.35	6.55	6.75	7.20
HSLB 2015-060-6		6				50	6	5,290	6.18	6.35	6.55	6.75	7.20
HSLB 2015-080		8				45	4	3,460	8.24	8.48	8.75	9.03	9.65
HSLB 2015-080-6		8				50	6	5,290	8.24	8.48	8.75	9.03	9.65
HSLB 2015-100		10				45	4	3,740	10.30	10.61	10.95	11.30	12.10
HSLB 2015-100-6		10				50	6	5,290	10.30	10.61	10.95	11.30	12.10
HSLB 2015-120		12				45	4	4,020	12.37	12.74	13.15	13.58	14.55
HSLB 2015-120-6		12				50	6	6,020	12.37	12.74	13.15	13.58	14.55
HSLB 2015-140		14				50	4	4,020	14.43	14.87	15.35	15.86	16.99
HSLB 2015-160		16				50	4	4,020	16.49	17.00	17.55	18.14	19.44
HSLB 2015-160-6		16				60	6	6,020	16.49	17.00	17.55	18.14	19.44
HSLB 2015-180		18				55	4	4,020	18.55	19.13	19.75	20.41	21.89
HSLB 2015-200		20				55	4	4,020	20.62	21.26	21.95	22.69	24.34
HSLB 2015-200-6		20				60	6	6,020	20.62	21.26	21.95	22.69	24.34
HSLB 2015-220		22				55	4	4,020	22.68	23.39	24.15	24.97	No Interference
HSLB 2015-250		25				65	4	5,600	25.77	26.59	27.45	28.38	No Interference
HSLB 2015-300		30				70	4	6,570	30.93	31.91	32.96	34.08	No Interference
HSLB 2016-040		R0.8				4	1.28	1.58	16°	45	4	4,560	4.09
HSLB 2016-080	8		45	4	4,650	8.22				8.46	8.72	9.00	9.62
HSLB 2016-120	12		45	4	4,650	12.35				12.72	13.12	13.55	14.51
HSLB 2016-160	16		50	4	4,650	16.47				16.98	17.53	18.11	19.41
HSLB 2016-200	20		55	4	4,650	20.60				21.24	21.93	22.66	No Interference
HSLB 2018-040	R0.9	4	1.44	1.78	16°	45	4	3,800	4.09	4.20	4.31	4.43	4.70
HSLB 2018-060		6				45	4	3,800	6.15	6.33	6.51	6.71	7.15
HSLB 2018-080		8				45	4	4,020	8.22	8.46	8.71	8.99	9.60
HSLB 2018-100		10				45	4	4,020	10.28	10.59	10.91	11.26	12.04
HSLB 2018-120		12				45	4	4,020	12.34	12.72	13.11	13.54	14.49
HSLB 2018-160		16				50	4	4,020	16.47	16.97	17.52	18.10	19.39
HSLB 2018-180		18				55	4	4,020	18.53	19.10	19.72	20.37	21.83
HSLB 2018-200		20				55	4	4,020	20.59	21.23	21.92	22.65	No Interference
HSLB 2018-220		22				60	4	5,500	22.66	23.36	24.12	24.93	No Interference
HSLB 2018-250		25				65	4	5,600	25.75	26.56	27.42	28.34	No Interference
HSLB 2018-300		30				70	4	6,340	30.91	31.88	32.92	No Interference	No Interference

Next Page →



Model Number	Radius of Ball Nose R	Effective Length l_1	Length of Cut l	Neck Diameter ϕd_1	Shank Taper Angle Bia	Overall Length L	Shank Diameter ϕd	Suggested Retail Price ¥	Effective Length by Inclined Angles				
									30°	1°	1°30'	2°	3°
HSLB 2020-030	R1	3	1.6	1.98	16°	45	4	2,820	3.06	3.13	3.20	3.28	3.46
HSLB 2020-040		4				45	4	2,820	4.09	4.19	4.30	4.42	4.68
HSLB 2020-040-6		4				50	6	4,470	4.09	4.19	4.30	4.42	4.68
HSLB 2020-060		6				45	4	3,190	6.15	6.32	6.50	6.70	7.13
HSLB 2020-060-6		6				50	6	4,830	6.15	6.32	6.50	6.70	7.13
HSLB 2020-080		8				45	4	3,460	8.21	8.45	8.70	8.97	9.58
HSLB 2020-080-6		8				50	6	5,200	8.21	8.45	8.70	8.97	9.58
HSLB 2020-100		10				45	4	3,460	10.28	10.58	10.90	11.25	12.02
HSLB 2020-100-6		10				50	6	5,200	10.28	10.58	10.90	11.25	12.02
HSLB 2020-120		12				45	4	3,460	12.34	12.71	13.10	13.53	14.47
HSLB 2020-120-6		12				50	6	5,200	12.34	12.71	13.10	13.53	14.47
HSLB 2020-130		13				45	4	3,460	13.37	13.77	14.20	14.67	15.69
HSLB 2020-140		14				50	4	3,460	14.40	14.84	15.31	15.80	16.92
HSLB 2020-160		16				50	4	3,460	16.46	16.97	17.51	18.08	19.36
HSLB 2020-160-6		16				60	6	5,200	16.46	16.97	17.51	18.08	19.36
HSLB 2020-180		18				55	4	3,460	18.53	19.10	19.71	20.36	No Interference
HSLB 2020-200		20				55	4	3,460	20.59	21.23	21.91	22.64	No Interference
HSLB 2020-200-6		20				70	6	5,200	20.59	21.23	21.91	22.64	24.26
HSLB 2020-220		22				60	4	4,740	22.65	23.36	24.11	24.91	No Interference
HSLB 2020-250		25				65	4	4,830	25.75	26.55	27.41	28.33	No Interference
HSLB 2020-250-6		25				80	6	6,840	25.75	26.55	27.41	28.33	30.38
HSLB 2020-270		27				65	4	4,830	27.81	28.68	29.61	No Interference	No Interference
HSLB 2020-300		30				70	4	5,470	30.90	31.88	32.91	No Interference	No Interference
HSLB 2020-300-6		30				80	6	7,750	30.90	31.88	32.91	34.02	36.50
HSLB 2020-320		32				70	4	5,470	32.97	34.01	35.11	No Interference	No Interference
HSLB 2020-350		35				80	4	7,480	36.06	37.20	38.42	No Interference	No Interference
HSLB 2020-350-6		35				80	6	10,120	36.06	37.20	38.42	39.72	No Interference
HSLB 2020-400		40				80	4	7,480	41.22	42.52	No Interference	No Interference	No Interference
HSLB 2020-400-6		40				90	6	10,120	41.22	42.52	43.92	45.41	No Interference
HSLB 2025-060		R1.25				6	2	2.45	16°	45	4	3,740	6.20
HSLB 2025-080	8		45	4	3,760	8.26				8.49	8.74	9.00	9.59
HSLB 2025-100	10		45	4	3,920	10.32				10.62	10.94	11.28	12.03
HSLB 2025-150	15		50	4	4,650	15.48				15.94	16.44	16.97	No Interference
HSLB 2025-200	20		55	4	5,470	20.64				21.27	21.94	22.66	No Interference
HSLB 2025-250	25		65	4	5,840	25.79				26.59	27.44	No Interference	No Interference
HSLB 2025-300	30		70	4	5,840	30.95				31.92	No Interference	No Interference	No Interference
HSLB 2025-350	35		70	4	6,750	36.11				37.24	No Interference	No Interference	No Interference

Next Page ➔

- $\phi 3\text{mm}$ Shank V Series
- UDC-PCD Series
- CBN Series
- Square
- Long Neck Square
- Radius
- Long Neck Radius
- Taper Neck Radius
- Ball / Long Shank Ball
- Long Neck Ball
- Taper Neck Ball
- Taper
- Barrel
- Spiral V Cutter
- Drill
- Technical Data

Unit (mm)

Model Number	Radius of Ball Nose R	Effective Length l_1	Length of Cut l	Neck Diameter ϕd_1	Shank Taper Angle β	Overall Length L	Shank Diameter ϕd	Suggested Retail Price ¥	Effective Length by Inclined Angles				
									30°	1°	1°30'	2°	3°
HSLB 2030-060	R1.5	6	2.4	2.95	16°	60	6	3,460	6.19	6.34	6.51	6.68	7.08
HSLB 2030-060-3		6			—	60	3	3,190	No Interference	No Interference	No Interference	No Interference	No Interference
HSLB 2030-060-4		6			60	4	3,190	6.19	6.34	6.51	6.68	7.08	
HSLB 2030-080		8			60	6	3,460	8.25	8.47	8.71	8.96	9.53	
HSLB 2030-100		10			60	6	4,020	10.31	10.60	10.91	11.24	11.98	
HSLB 2030-120		12			60	6	4,190	12.38	12.73	13.11	13.52	14.42	
HSLB 2030-140		14			60	6	4,650	14.44	14.86	15.31	15.79	16.87	
HSLB 2030-150		15			60	6	4,560	15.47	15.93	16.41	16.93	18.09	
HSLB 2030-160		16			60	6	4,650	16.50	16.99	17.51	18.07	19.32	
HSLB 2030-180		18			60	6	4,650	18.56	19.12	19.71	20.35	21.77	
HSLB 2030-200		20			70	6	4,470	20.63	21.25	21.91	22.63	24.21	
HSLB 2030-220		22			70	6	4,470	22.69	23.38	24.12	24.90	26.66	
HSLB 2030-250		25			70	6	4,470	25.78	26.57	27.42	28.32	30.33	
HSLB 2030-270		27			70	6	4,470	27.85	28.70	29.62	30.60	No Interference	
HSLB 2030-300		30			70	6	5,100	30.94	31.90	32.92	34.01	No Interference	
HSLB 2030-320		32			80	6	6,470	33.00	34.03	35.12	36.29	No Interference	
HSLB 2030-350	35	80	6	6,470	36.10	37.22	38.42	39.71	No Interference				
HSLB 2030-400	40	80	6	8,020	41.25	42.55	43.92	No Interference	No Interference				
HSLB 2035-100	R1.75	10	2.8	3.45	16°	60	6	5,100	10.31	10.59	10.88	11.21	11.92
HSLB 2035-150		15				60	6	5,100	15.46	15.91	16.39	16.90	18.04
HSLB 2035-200		20				65	6	5,470	20.62	21.23	21.89	22.59	24.16
HSLB 2035-250		25				70	6	5,470	25.78	26.56	27.39	28.29	No Interference
HSLB 2035-300		30				70	6	5,840	30.93	31.88	32.89	33.98	No Interference
HSLB 2035-400		40				90	6	7,750	41.25	42.53	43.90	No Interference	No Interference
HSLB 2035-450		45				90	6	8,480	46.40	47.85	49.40	No Interference	No Interference
HSLB 2040-080	R2	8	3.2	3.95	16°	70	6	3,560	8.23	8.44	8.66	8.89	9.42
HSLB 2040-080-4		8			—	70	4	3,340	No Interference	No Interference	No Interference	No Interference	No Interference
HSLB 2040-100		10			70	6	3,560	10.30	10.57	10.86	11.17	11.87	
HSLB 2040-120		12			70	6	4,650	12.36	12.70	13.06	13.45	14.31	
HSLB 2040-140		14			70	6	4,650	14.42	14.83	15.26	15.73	16.76	
HSLB 2040-150		15			70	6	4,650	15.45	15.89	16.36	16.86	17.99	
HSLB 2040-160		16			70	6	4,650	16.49	16.96	17.46	18.00	19.21	
HSLB 2040-180		18			70	6	4,650	18.55	19.09	19.66	20.28	No Interference	
HSLB 2040-200		20			70	6	4,650	20.61	21.22	21.86	22.56	No Interference	
HSLB 2040-220		22			70	6	4,650	22.67	23.35	24.07	24.84	No Interference	
HSLB 2040-250		25			70	6	4,650	25.77	26.54	27.37	28.25	No Interference	
HSLB 2040-270		27			70	6	4,650	27.83	28.67	29.57	30.53	No Interference	
HSLB 2040-300		30			70	6	4,650	30.93	31.87	32.87	No Interference	No Interference	
HSLB 2040-320		32			80	6	5,380	32.99	34.00	35.07	No Interference	No Interference	
HSLB 2040-350		35			80	6	5,380	36.08	37.19	38.37	No Interference	No Interference	
HSLB 2040-400		40			90	6	6,020	41.24	42.51	No Interference	No Interference	No Interference	
HSLB 2040-450	45	90	6	7,750	46.40	47.84	No Interference	No Interference	No Interference				
HSLB 2040-500	50	100	6	8,300	51.55	53.16	No Interference	No Interference	No Interference				
HSLB 2040-600	60	120	6	8,460	61.87	No Interference	No Interference	No Interference	No Interference				

3mm Shank
V Series

UDC-PCD
Series

CBN
Series

Square

Long Neck
Square

Radius

Long Neck
Radius

Taper Neck
Radius

Ball / Long
Shank Ball

Long Neck
Ball

Taper Neck
Ball

Taper

Barrel

Spiral
V Cutter

Drill

Technical Data

Model Number	Radius of Ball Nose R	Effective Length l_1	Length of Cut l	Neck Diameter ϕd_1	Shank Taper Angle Bia	Overall Length L	Shank Diameter ϕd	Suggested Retail Price ¥	Effective Length by Inclined Angles				
									30°	1°	1°30'	2°	3°
HSLB 2050-100	R2.5	10	4	4.95	16°	70	6	5,470	10.28	10.54	10.81	11.10	11.76
HSLB 2050-150		15				70	6	7,750	15.44	15.86	16.31	16.80	No Interference
HSLB 2050-200		20				70	6	7,750	20.60	21.19	21.82	No Interference	No Interference
HSLB 2050-250		25				70	6	7,750	25.75	26.51	No Interference	No Interference	No Interference
HSLB 2050-300		30				80	6	8,300	30.91	31.83	No Interference	No Interference	No Interference
HSLB 2050-350		35				80	6	8,300	36.07	No Interference	No Interference	No Interference	No Interference
HSLB 2050-400		40				90	6	10,490	41.22	No Interference	No Interference	No Interference	No Interference
HSLB 2050-450		45				100	6	10,940	46.38	No Interference	No Interference	No Interference	No Interference
HSLB 2050-500		50				100	6	11,860	51.54	No Interference	No Interference	No Interference	No Interference
HSLB 2060-100		R3				10	4.8	5.95	—	80	6	5,840	No Interference
HSLB 2060-150	15		80	6	5,840	No Interference				No Interference	No Interference	No Interference	No Interference
HSLB 2060-180	18		80	6	5,840	No Interference				No Interference	No Interference	No Interference	No Interference
HSLB 2060-200	20		80	6	5,840	No Interference				No Interference	No Interference	No Interference	No Interference
HSLB 2060-220	22		80	6	5,840	No Interference				No Interference	No Interference	No Interference	No Interference
HSLB 2060-250	25		80	6	5,840	No Interference				No Interference	No Interference	No Interference	No Interference
HSLB 2060-270	27		80	6	5,840	No Interference				No Interference	No Interference	No Interference	No Interference
HSLB 2060-300	30		80	6	6,020	No Interference				No Interference	No Interference	No Interference	No Interference
HSLB 2060-320	32		80	6	6,020	No Interference				No Interference	No Interference	No Interference	No Interference
HSLB 2060-350	35		80	6	6,200	No Interference				No Interference	No Interference	No Interference	No Interference
HSLB 2060-400	40		90	6	6,570	No Interference				No Interference	No Interference	No Interference	No Interference
HSLB 2060-450	45		100	6	7,020	No Interference				No Interference	No Interference	No Interference	No Interference
HSLB 2060-500	50		120	6	7,110	No Interference				No Interference	No Interference	No Interference	No Interference
HSLB 2060-600	60		120	6	7,540	No Interference				No Interference	No Interference	No Interference	No Interference

φ3mm Shank V Series

UDC-PCD Series

CBN Series

Square
Long Neck Square

Radius

Long Neck Radius

Taper Neck Radius

Ball / Long Shank Ball
Long Neck Ball
Taper Neck Ball

Taper

Barrel

Spiral V Cutter

Drill

Technical Data

Milling Conditions for HSLB / HSLB-S

WORK MATERIAL			PREHARDENED STEELS HARDENED STEELS NAK / STAVAX (~55HRC)				HARDENED STEELS SKD11 (55~62HRC)				HARDENED STEELS HAP10 (62~66HRC)				HARDENED STEELS HAP72 (66~70HRC)			
Model Number	Radius of Ball Nose (mm)	Effective Length (mm)	Spindle Speed (min ⁻¹)	Feed Rate (mm/min)	a _p Axial Depth (mm)	a _e Radial Depth (mm)	Spindle Speed (min ⁻¹)	Feed Rate (mm/min)	a _p Axial Depth (mm)	a _e Radial Depth (mm)	Spindle Speed (min ⁻¹)	Feed Rate (mm/min)	a _p Axial Depth (mm)	a _e Radial Depth (mm)	Spindle Speed (min ⁻¹)	Feed Rate (mm/min)	a _p Axial Depth (mm)	a _e Radial Depth (mm)
2001	R0.05	0.2	48,000	55	0.002	0.002	48,000	45	0.002	0.002	48,000	45	0.002	0.002	36,000	22	0.002	0.002
		0.3	48,000	55	0.002	0.002	48,000	45	0.002	0.002	48,000	45	0.002	0.002	36,000	22	0.002	0.002
		0.5	48,000	35	0.002	0.002	48,000	35	0.002	0.002	48,000	35	0.002	0.002	36,000	17	0.002	0.002
20015	R0.075	0.3	48,000	90	0.004	0.004	48,000	70	0.004	0.004	48,000	70	0.004	0.004	36,000	35	0.004	0.004
		0.5	48,000	60	0.004	0.004	48,000	50	0.004	0.004	48,000	50	0.004	0.004	36,000	25	0.004	0.004
		1	48,000	60	0.001	0.002	48,000	20	0.001	0.002	48,000	20	0.001	0.002	36,000	10	0.001	0.002
2002	R0.1	0.3	60,000	200	0.003	0.005	60,000	200	0.002	0.003	60,000	130	0.002	0.003	45,000	65	0.002	0.003
		0.5	60,000	200	0.003	0.005	60,000	200	0.002	0.003	60,000	130	0.002	0.003	45,000	65	0.002	0.003
		0.75	60,000	200	0.003	0.005	60,000	200	0.002	0.003	60,000	130	0.002	0.003	45,000	65	0.002	0.003
		1	60,000	200	0.003	0.005	60,000	200	0.002	0.003	60,000	130	0.002	0.003	45,000	65	0.002	0.003
		1.25	60,000	160	0.002	0.004	54,000	140	0.001	0.002	54,000	95	0.001	0.002	40,500	45	0.001	0.002
		1.5	60,000	130	0.002	0.003	48,000	80	0.001	0.002	48,000	65	0.001	0.002	36,000	30	0.001	0.002
		1.75	60,000	110	0.001	0.002	48,000	60	0.001	0.001	48,000	50	0.001	0.001	36,000	25	0.001	0.001
		2	60,000	90	0.001	0.002	48,000	50	0.001	0.001	48,000	40	0.001	0.001	36,000	20	0.001	0.001
		2.25	53,000	70	0.001	0.001	44,200	40	0.001	0.001	44,200	30	0.001	0.001	33,180	15	0.001	0.001
		2.5	46,850	60	0.001	0.001	40,450	30	0.001	0.001	40,450	20	0.001	0.001	30,350	10	0.001	0.001
3	33,750	30	0.001	0.001	33,600	20	0.001	0.001	33,600	15	0.001	0.001	25,200	7	0.001	0.001		
2003	R0.15	0.5	60,000	350	0.006	0.008	45,000	310	0.004	0.007	43,500	180	0.003	0.005	32,500	90	0.003	0.005
		0.6	60,000	350	0.006	0.008	45,000	310	0.004	0.007	43,500	180	0.003	0.005	32,500	90	0.003	0.005
		0.75	60,000	350	0.006	0.008	45,000	310	0.004	0.007	43,500	180	0.003	0.005	32,500	90	0.003	0.005
		1	60,000	350	0.006	0.008	45,000	310	0.004	0.007	43,500	180	0.003	0.005	32,500	90	0.003	0.005
		1.25	60,000	350	0.006	0.008	45,000	310	0.004	0.007	43,500	180	0.003	0.005	32,500	90	0.003	0.005
		1.5	60,000	350	0.006	0.008	45,000	310	0.004	0.007	43,500	180	0.003	0.005	32,500	90	0.003	0.005
		1.75	60,000	280	0.005	0.007	45,000	250	0.003	0.006	43,500	145	0.002	0.004	32,500	70	0.002	0.004
		2	60,000	210	0.004	0.007	45,000	190	0.003	0.005	43,500	110	0.002	0.004	32,500	55	0.002	0.004
		2.25	55,600	190	0.003	0.006	41,500	160	0.002	0.004	40,000	95	0.001	0.003	30,000	45	0.001	0.003
		2.5	51,250	175	0.003	0.005	38,500	135	0.002	0.004	37,750	85	0.001	0.003	28,300	40	0.001	0.003
3	42,500	140	0.002	0.004	32,000	80	0.002	0.004	32,000	65	0.001	0.002	24,000	30	0.001	0.002		
4	23,900	45	0.001	0.001	22,550	30	0.001	0.001	22,300	20	0.001	0.001	16,720	10	0.001	0.001		
5	21,000	30	0.001	0.001	20,000	20	0.001	0.001	19,500	10	0.001	0.001	14,600	5	0.001	0.001		
2004	R0.2	0.5	50,000	500	0.01	0.02	37,500	420	0.007	0.012	35,000	240	0.005	0.008	26,250	120	0.005	0.008
		0.75	50,000	500	0.01	0.02	37,500	420	0.007	0.012	35,000	240	0.005	0.008	26,250	120	0.005	0.008
		1	50,000	500	0.01	0.02	37,500	420	0.007	0.012	35,000	240	0.005	0.008	26,250	120	0.005	0.008
		1.25	50,000	500	0.01	0.02	37,500	420	0.007	0.012	35,000	240	0.005	0.008	26,250	120	0.005	0.008
		1.5	50,000	500	0.01	0.02	37,500	420	0.007	0.012	35,000	240	0.005	0.008	26,250	120	0.005	0.008
		1.75	50,000	500	0.01	0.02	37,500	420	0.007	0.012	35,000	240	0.005	0.008	26,250	120	0.005	0.008
		2	50,000	500	0.01	0.02	37,500	420	0.007	0.012	35,000	240	0.005	0.008	26,250	120	0.005	0.008
		2.25	47,500	430	0.008	0.016	36,000	360	0.006	0.01	33,750	210	0.004	0.007	25,270	100	0.004	0.007
		2.5	45,000	360	0.007	0.012	34,500	300	0.005	0.008	32,500	190	0.004	0.007	24,300	95	0.004	0.007
		3	40,000	250	0.005	0.008	31,900	210	0.004	0.008	30,500	160	0.003	0.005	22,800	80	0.003	0.005
		3.5	36,000	210	0.004	0.007	28,700	180	0.003	0.006	27,400	140	0.002	0.004	20,550	70	0.002	0.004
		4	32,000	180	0.003	0.005	25,500	150	0.002	0.004	24,300	120	0.002	0.004	18,200	60	0.002	0.004
		4.5	28,500	150	0.002	0.004	23,500	125	0.002	0.003	22,400	100	0.001	0.003	16,800	50	0.001	0.003
5	25,000	120	0.002	0.003	21,500	100	0.001	0.002	20,500	80	0.001	0.002	15,350	40	0.001	0.002		
6	18,000	60	0.001	0.002	18,000	60	0.001	0.002	17,000	45	0.001	0.002	12,750	20	0.001	0.002		

Ø3mm Shank
V SeriesUDC-PCD
SeriesCBN
SeriesSquare
Long Neck
Square

Radius

Radius
Long Neck
Radius
Taper Neck
RadiusBall / Long
Shank BallBall
Long Neck
Ball
Taper Neck
BallTaper
Taper

Barrel

Spiral
V Cutter

Drill

Technical Data

Milling Conditions for HSLB / HSLB-S

WORK MATERIAL			PREHARDENED STEELS HARDENED STEELS NAK / STAVAX (~55HRC)				HARDENED STEELS SKD11 (55~62HRC)				HARDENED STEELS HAP10 (62~66HRC)				HARDENED STEELS HAP72 (66~70HRC)			
Model Number	Radius of Ball Nose (mm)	Effective Length (mm)	Spindle Speed (min ⁻¹)	Feed Rate (mm/min)	a _p Axial Depth (mm)	a _e Radial Depth (mm)	Spindle Speed (min ⁻¹)	Feed Rate (mm/min)	a _p Axial Depth (mm)	a _e Radial Depth (mm)	Spindle Speed (min ⁻¹)	Feed Rate (mm/min)	a _p Axial Depth (mm)	a _e Radial Depth (mm)	Spindle Speed (min ⁻¹)	Feed Rate (mm/min)	a _p Axial Depth (mm)	a _e Radial Depth (mm)
2005	R0.25	1	44,000	650	0.015	0.04	33,000	530	0.01	0.02	30,000	300	0.007	0.01	22,500	150	0.007	0.01
		1.25	44,000	650	0.015	0.04	33,000	530	0.01	0.02	30,000	300	0.007	0.01	22,500	150	0.007	0.01
		1.5	44,000	650	0.015	0.04	33,000	530	0.01	0.02	30,000	300	0.007	0.01	22,500	150	0.007	0.01
		1.75	44,000	650	0.015	0.04	33,000	530	0.01	0.02	30,000	300	0.007	0.01	22,500	150	0.007	0.01
		2	44,000	650	0.015	0.04	33,000	530	0.01	0.02	30,000	300	0.007	0.01	22,500	150	0.007	0.01
		2.25	44,000	650	0.015	0.04	33,000	530	0.01	0.02	30,000	300	0.007	0.01	22,500	150	0.007	0.01
		2.5	44,000	650	0.015	0.04	33,000	530	0.01	0.02	30,000	300	0.007	0.01	22,500	150	0.007	0.01
		3	40,000	500	0.01	0.02	31,000	400	0.007	0.01	28,550	230	0.005	0.008	21,400	115	0.005	0.008
		3.5	36,350	340	0.007	0.017	29,000	270	0.005	0.008	27,100	160	0.003	0.006	20,300	80	0.003	0.006
		4	32,700	180	0.005	0.015	27,150	150	0.003	0.008	25,650	100	0.002	0.005	19,900	50	0.002	0.005
		4.5	29,900	150	0.004	0.01	25,700	130	0.002	0.007	24,500	85	0.002	0.004	18,350	43	0.002	0.004
		5	27,000	135	0.003	0.008	24,200	110	0.002	0.005	23,500	75	0.002	0.004	17,600	35	0.002	0.004
		5.5	24,150	110	0.002	0.006	22,750	90	0.001	0.004	22,400	60	0.001	0.003	16,800	30	0.001	0.003
		6	21,350	90	0.002	0.005	21,300	75	0.001	0.003	21,300	50	0.001	0.002	16,000	25	0.001	0.002
7	18,600	75	0.001	0.004	18,600	55	0.001	0.002	18,600	35	0.001	0.002	13,950	17	0.001	0.002		
8	15,900	60	0.001	0.003	15,900	40	0.001	0.002	15,900	25	0.001	0.002	11,950	12	0.001	0.002		
9	15,400	55	0.001	0.002	14,750	30	0.001	0.001	14,750	20	0.001	0.001	11,050	10	0.001	0.001		
10	14,900	50	0.001	0.002	13,600	20	0.001	0.001	13,600	15	0.001	0.001	10,200	7	0.001	0.001		
2006	R0.3	1	40,000	1,400	0.045	0.15	30,000	1,500	0.03	0.13	26,500	1,000	0.015	0.09	20,000	500	0.015	0.09
		1.25	40,000	1,250	0.035	0.14	30,000	1,350	0.025	0.11	26,500	900	0.01	0.08	20,000	450	0.01	0.08
		1.5	40,000	1,100	0.03	0.13	30,000	1,200	0.02	0.1	26,500	800	0.01	0.075	20,000	400	0.01	0.075
		1.75	40,000	1,100	0.03	0.13	30,000	1,200	0.02	0.1	26,500	800	0.01	0.075	20,000	400	0.01	0.075
		2	40,000	1,100	0.03	0.13	30,000	1,200	0.02	0.1	26,500	800	0.01	0.075	20,000	400	0.01	0.075
		2.25	40,000	950	0.025	0.1	30,000	1,000	0.015	0.09	26,500	660	0.008	0.065	20,000	330	0.008	0.07
		2.5	40,000	800	0.02	0.1	30,000	800	0.015	0.09	26,500	520	0.008	0.065	20,000	260	0.008	0.065
		3	40,000	800	0.02	0.1	30,000	800	0.015	0.09	26,500	520	0.008	0.065	20,000	260	0.008	0.065
		3.5	40,000	500	0.015	0.09	30,000	500	0.01	0.075	26,500	340	0.006	0.05	20,000	170	0.006	0.05
		4	40,000	500	0.015	0.09	30,000	500	0.01	0.075	26,500	340	0.006	0.05	20,000	170	0.006	0.05
		4.5	32,000	400	0.01	0.075	25,000	390	0.007	0.05	23,000	260	0.005	0.04	18,000	130	0.005	0.04
		5	32,000	400	0.01	0.075	25,000	390	0.007	0.05	23,000	260	0.005	0.04	18,000	130	0.005	0.04
		5.5	28,000	350	0.008	0.065	23,000	350	0.006	0.05	21,000	230	0.004	0.04	15,750	115	0.004	0.04
		6	24,000	300	0.007	0.06	21,000	320	0.005	0.04	19,500	210	0.004	0.03	15,000	105	0.004	0.03
6.5	22,000	270	0.006	0.06	19,500	300	0.004	0.04	18,500	190	0.003	0.03	13,900	95	0.003	0.03		
7	20,000	250	0.006	0.05	18,500	280	0.004	0.03	17,500	180	0.003	0.02	13,100	90	0.003	0.02		
8	16,000	200	0.005	0.05	16,000	240	0.003	0.02	16,000	160	0.003	0.02	12,000	80	0.003	0.02		
9	15,450	185	0.004	0.035	15,450	200	0.002	0.017	15,450	135	0.002	0.017	11,580	65	0.002	0.017		
10	14,900	175	0.003	0.02	14,900	175	0.002	0.015	14,900	115	0.002	0.015	11,100	55	0.002	0.015		
12	13,800	150	0.002	0.015	13,800	110	0.001	0.01	13,800	70	0.001	0.01	10,350	35	0.001	0.01		
2007	R0.35	2	37,000	1,350	0.045	0.17	28,500	1,400	0.03	0.135	25,000	900	0.015	0.1	18,750	450	0.015	0.1
		4	31,250	920	0.035	0.15	25,750	975	0.025	0.12	23,750	650	0.012	0.09	17,800	325	0.012	0.09
		6	25,500	500	0.025	0.13	23,000	550	0.02	0.11	22,500	400	0.01	0.08	16,850	200	0.01	0.08
		8	19,000	270	0.007	0.06	17,000	320	0.005	0.04	16,500	220	0.004	0.025	12,350	110	0.004	0.025

Milling Conditions for HSLB / HSLB-S

WORK MATERIAL			PREHARDENED STEELS HARDENED STEELS NAK / STAVAX (~55HRC)				HARDENED STEELS SKD11 (55~62HRC)				HARDENED STEELS HAP10 (62~66HRC)				HARDENED STEELS HAP72 (66~70HRC)			
Model Number	Radius of Ball Nose (mm)	Effective Length (mm)	Spindle Speed (min ⁻¹)	Feed Rate (mm/min)	a _p Axial Depth (mm)	a _e Radial Depth (mm)	Spindle Speed (min ⁻¹)	Feed Rate (mm/min)	a _p Axial Depth (mm)	a _e Radial Depth (mm)	Spindle Speed (min ⁻¹)	Feed Rate (mm/min)	a _p Axial Depth (mm)	a _e Radial Depth (mm)	Spindle Speed (min ⁻¹)	Feed Rate (mm/min)	a _p Axial Depth (mm)	a _e Radial Depth (mm)
2008	R0.4	2	35,000	1,600	0.06	0.21	27,000	1,600	0.04	0.17	23,500	1,000	0.02	0.12	17,500	500	0.02	0.12
		3	35,000	1,400	0.05	0.19	27,000	1,400	0.03	0.15	23,500	900	0.015	0.1	17,500	450	0.015	0.1
		4	35,000	1,200	0.04	0.17	27,000	1,200	0.025	0.135	23,500	600	0.012	0.095	17,500	300	0.012	0.095
		5	31,500	900	0.03	0.15	25,000	900	0.02	0.12	22,000	500	0.01	0.085	16,500	250	0.01	0.085
		6	28,000	600	0.02	0.12	23,000	600	0.012	0.095	20,500	400	0.006	0.065	15,500	200	0.006	0.065
		7	23,750	460	0.016	0.105	20,500	480	0.009	0.08	18,750	340	0.005	0.062	14,000	170	0.005	0.062
		8	19,500	330	0.012	0.095	18,000	375	0.007	0.07	17,000	285	0.005	0.06	12,750	140	0.005	0.06
		9	17,500	290	0.011	0.09	16,000	350	0.006	0.06	15,700	250	0.005	0.05	11,800	125	0.005	0.05
		10	15,000	260	0.01	0.085	14,700	340	0.005	0.06	14,650	225	0.004	0.05	11,000	110	0.004	0.05
		12	14,000	220	0.005	0.06	13,700	290	0.003	0.04	13,650	140	0.002	0.03	10,250	70	0.002	0.03
16	13,300	185	0.003	0.02	11,100	150	0.001	0.013	11,100	90	0.001	0.013	8,300	45	0.001	0.013		
2009	R0.45	2	32,500	1,650	0.1	0.28	25,500	1,800	0.055	0.21	22,000	1,300	0.025	0.14	16,500	650	0.025	0.14
		4	32,500	1,650	0.08	0.25	25,500	1,800	0.04	0.18	22,000	1,300	0.02	0.13	16,500	650	0.02	0.13
		6	29,000	800	0.035	0.17	22,000	800	0.02	0.13	20,000	620	0.015	0.11	15,000	310	0.015	0.11
		8	25,500	700	0.015	0.11	18,500	500	0.01	0.09	18,500	420	0.01	0.09	13,850	210	0.01	0.09
		10	20,000	400	0.012	0.1	15,700	400	0.008	0.08	15,700	300	0.008	0.08	11,800	150	0.008	0.08
		12	15,000	280	0.01	0.09	13,300	300	0.006	0.07	13,300	220	0.006	0.07	10,000	110	0.006	0.07
		14	14,000	240	0.007	0.07	12,000	250	0.004	0.035	12,000	160	0.004	0.035	9,000	80	0.004	0.035
		16	13,700	220	0.005	0.05	10,800	200	0.003	0.03	10,800	130	0.003	0.03	8,100	65	0.003	0.03
18	13,000	200	0.004	0.025	9,750	150	0.002	0.015	9,750	100	0.002	0.015	7,300	50	0.002	0.015		
2010	R0.5	2	30,000	1,750	0.2	0.4	24,000	2,000	0.1	0.3	21,000	1,750	0.05	0.2	16,000	875	0.05	0.2
		2.5	30,000	1,750	0.2	0.4	24,000	2,000	0.1	0.3	21,000	1,750	0.05	0.2	16,000	875	0.05	0.2
		3	30,000	1,750	0.1	0.3	24,000	2,000	0.05	0.2	21,000	1,750	0.03	0.17	16,000	875	0.03	0.17
		4	30,000	1,750	0.1	0.3	24,000	2,000	0.05	0.2	21,000	1,750	0.03	0.17	16,000	875	0.03	0.17
		5	30,000	1,750	0.1	0.3	24,000	2,000	0.05	0.2	21,000	1,750	0.03	0.17	16,000	875	0.03	0.17
		6	30,000	1,150	0.06	0.23	21,500	1,250	0.03	0.17	19,700	1,050	0.025	0.15	14,500	525	0.025	0.15
		7	24,250	800	0.04	0.19	20,000	900	0.02	0.14	19,000	750	0.02	0.14	14,250	375	0.02	0.14
		8	24,000	800	0.025	0.155	18,500	580	0.015	0.12	18,400	480	0.015	0.12	13,800	240	0.015	0.12
		9	23,000	700	0.021	0.14	16,650	500	0.012	0.1	16,550	420	0.012	0.1	12,400	210	0.012	0.1
		10	22,000	600	0.018	0.13	14,800	430	0.01	0.09	14,700	360	0.01	0.09	11,100	180	0.01	0.09
		12	14,150	320	0.015	0.12	13,400	380	0.008	0.08	13,300	290	0.008	0.08	9,950	145	0.008	0.08
		14	13,500	280	0.012	0.1	12,000	350	0.007	0.08	12,000	220	0.007	0.08	9,000	110	0.007	0.08
		16	12,750	240	0.008	0.08	10,500	250	0.005	0.045	10,500	160	0.005	0.045	7,850	80	0.005	0.045
		18	12,350	220	0.006	0.065	9,750	200	0.004	0.035	9,750	130	0.004	0.035	7,300	65	0.004	0.035
20	12,000	200	0.005	0.03	9,000	150	0.003	0.02	9,000	100	0.003	0.02	6,750	50	0.003	0.02		
22	12,000	150	0.003	0.02	9,000	110	0.002	0.012	9,000	75	0.002	0.012	6,750	35	0.002	0.012		
2012	R0.6	2.5	30,000	2,000	0.22	0.46	20,500	2,000	0.11	0.34	17,800	1,750	0.05	0.23	13,350	875	0.05	0.23
		4	30,000	2,000	0.12	0.36	20,000	2,000	0.06	0.24	17,500	1,750	0.036	0.2	13,100	875	0.036	0.2
		6	30,000	2,000	0.12	0.36	20,000	2,000	0.06	0.24	17,500	1,750	0.036	0.2	13,100	875	0.036	0.2
		8	20,200	800	0.05	0.23	16,600	900	0.025	0.17	15,850	750	0.025	0.17	11,900	375	0.025	0.17
		10	15,500	480	0.03	0.18	15,500	580	0.015	0.13	15,350	480	0.015	0.13	11,500	240	0.015	0.13
		12	12,400	360	0.02	0.15	12,400	430	0.01	0.095	12,250	360	0.01	0.095	9,200	180	0.01	0.095
		14	11,850	320	0.018	0.14	11,200	380	0.008	0.085	11,100	290	0.008	0.085	8,300	145	0.008	0.085
		16	11,300	280	0.014	0.12	10,000	360	0.007	0.08	10,000	230	0.007	0.08	7,500	115	0.007	0.08
		18	10,900	260	0.011	0.1	9,400	300	0.006	0.07	9,400	190	0.006	0.07	7,050	95	0.006	0.07
		20	10,500	240	0.009	0.09	8,800	250	0.006	0.05	8,800	160	0.006	0.05	6,600	80	0.006	0.05

Ø3mm Shank
V SeriesUDC-PCD
SeriesCBN
Series

Square

Long Neck
Square

Radius

Long Neck
RadiusTaper Neck
RadiusBall / Long
Shank BallLong Neck
BallTaper Neck
Ball

Taper

Barrel

Spiral
V Cutter

Drill

Technical Data

Milling Conditions for HSLB / HSLB-S

WORK MATERIAL			PREHARDENED STEELS HARDENED STEELS NAK / STAVAX (~55HRC)				HARDENED STEELS SKD11 (55~62HRC)				HARDENED STEELS HAP10 (62~66HRC)				HARDENED STEELS HAP72 (66~70HRC)			
Model Number	Radius of Ball Nose (mm)	Effective Length (mm)	Spindle Speed (min ⁻¹)	Feed Rate (mm/min)	a _p Axial Depth (mm)	a _e Radial Depth (mm)	Spindle Speed (min ⁻¹)	Feed Rate (mm/min)	a _p Axial Depth (mm)	a _e Radial Depth (mm)	Spindle Speed (min ⁻¹)	Feed Rate (mm/min)	a _p Axial Depth (mm)	a _e Radial Depth (mm)	Spindle Speed (min ⁻¹)	Feed Rate (mm/min)	a _p Axial Depth (mm)	a _e Radial Depth (mm)
2014	R0.7	6	25,200	2,000	0.13	0.42	17,150	2,000	0.065	0.27	15,000	1,750	0.036	0.23	11,250	875	0.036	0.23
		8	25,200	1,300	0.08	0.32	15,350	1,250	0.04	0.23	14,050	1,050	0.03	0.2	10,550	525	0.03	0.2
		12	13,500	450	0.035	0.21	12,500	460	0.025	0.18	12,000	300	0.02	0.16	9,000	150	0.02	0.16
		16	10,000	320	0.016	0.145	9,050	390	0.01	0.12	8,850	230	0.012	0.12	6,650	115	0.012	0.12
2015	R0.75	3	30,000	2,450	0.25	0.55	17,000	2,000	0.12	0.4	15,000	1,750	0.06	0.29	11,250	875	0.06	0.29
		4	30,000	2,450	0.25	0.55	17,000	2,000	0.12	0.4	15,000	1,750	0.06	0.29	11,250	875	0.06	0.29
		6	30,000	2,450	0.15	0.45	17,000	2,000	0.07	0.31	15,000	1,750	0.04	0.24	11,250	875	0.04	0.24
		8	23,500	1,300	0.1	0.37	15,000	1,250	0.045	0.25	14,000	1,050	0.03	0.21	10,500	525	0.03	0.21
		10	23,500	1,300	0.1	0.37	15,000	1,250	0.045	0.25	14,000	1,050	0.03	0.21	10,500	525	0.03	0.21
		12	13,100	480	0.03	0.21	13,000	580	0.02	0.17	13,000	480	0.02	0.17	9,750	240	0.02	0.17
		14	11,200	400	0.025	0.19	10,900	485	0.015	0.145	10,900	385	0.015	0.145	8,200	190	0.015	0.145
		16	9,350	320	0.02	0.17	8,850	390	0.012	0.13	8,800	290	0.012	0.13	6,600	145	0.012	0.13
		18	9,150	300	0.019	0.165	8,400	370	0.011	0.125	8,400	255	0.011	0.125	6,300	125	0.011	0.125
		20	9,000	280	0.018	0.16	8,000	350	0.01	0.12	8,000	220	0.01	0.12	6,000	110	0.01	0.12
		22	8,580	245	0.014	0.13	7,150	320	0.008	0.12	7,150	165	0.008	0.12	5,350	80	0.008	0.12
		25	8,100	210	0.01	0.11	6,250	220	0.006	0.09	6,250	120	0.005	0.08	4,700	60	0.005	0.08
2016	R0.8	4	30,000	2,500	0.25	0.58	17,500	2,100	0.12	0.4	15,300	1,800	0.06	0.3	11,500	900	0.06	0.3
		8	30,000	2,500	0.16	0.48	17,500	2,100	0.08	0.32	15,300	1,800	0.05	0.275	11,500	900	0.05	0.275
		12	13,500	500	0.04	0.245	13,500	600	0.024	0.19	13,400	490	0.024	0.19	10,050	245	0.024	0.19
		16	10,800	375	0.03	0.21	10,800	450	0.016	0.15	10,700	370	0.016	0.15	8,000	185	0.016	0.15
		20	10,300	330	0.025	0.19	9,750	400	0.013	0.13	9,650	230	0.013	0.13	8,000	115	0.013	0.13
2018	R0.9	4	30,000	2,700	0.28	0.65	15,000	2,000	0.14	0.48	13,000	1,750	0.07	0.34	9,750	875	0.07	0.34
		6	30,000	2,700	0.18	0.54	15,000	2,000	0.07	0.34	13,000	1,750	0.04	0.26	9,750	875	0.04	0.26
		8	30,000	2,700	0.18	0.54	15,000	2,000	0.07	0.34	13,000	1,750	0.04	0.26	9,750	875	0.04	0.26
		10	25,750	2,000	0.14	0.48	14,400	1,650	0.06	0.32	12,900	1,425	0.035	0.24	9,700	713	0.035	0.24
		12	21,500	1,350	0.1	0.41	13,800	1,350	0.05	0.29	12,800	1,100	0.03	0.23	9,600	550	0.03	0.23
		16	15,550	860	0.065	0.33	11,700	900	0.03	0.22	11,150	730	0.02	0.18	8,400	385	0.02	0.18
		18	9,600	375	0.03	0.23	9,600	450	0.015	0.16	9,500	370	0.01	0.13	7,150	185	0.01	0.13
		20	9,300	350	0.027	0.21	9,050	420	0.014	0.15	9,000	330	0.009	0.12	6,750	165	0.009	0.12
		22	9,000	320	0.025	0.2	8,500	400	0.012	0.14	8,500	290	0.008	0.15	6,400	145	0.008	0.15
		25	8,500	280	0.02	0.18	7,750	320	0.01	0.1	7,750	220	0.007	0.09	5,800	110	0.007	0.09
30	8,000	240	0.015	0.15	7,000	250	0.009	0.07	7,000	160	0.006	0.06	5,250	80	0.006	0.06		

- φ3mm Shank V Series
- UDC-PCD Series
- CBN Series
- Square
- Long Neck Square
- Radius
- Long Neck Radius
- Taper Neck Radius
- Ball / Long Shank Ball
- Long Neck Ball
- Taper Neck Ball
- Taper
- Barrel
- Spiral V Cutter
- Drill
- Technical Data

Milling Conditions for HSLB / HSLB-S

WORK MATERIAL			PREHARDENED STEELS HARDENED STEELS NAK / STAVAX (~55HRC)				HARDENED STEELS SKD11 (55~62HRC)				HARDENED STEELS HAP10 (62~66HRC)				HARDENED STEELS HAP72 (66~70HRC)			
Model Number	Radius of Ball Nose (mm)	Effective Length (mm)	Spindle Speed (min ⁻¹)	Feed Rate (mm/min)	a_p Axial Depth (mm)	a_e Radial Depth (mm)	Spindle Speed (min ⁻¹)	Feed Rate (mm/min)	a_p Axial Depth (mm)	a_e Radial Depth (mm)	Spindle Speed (min ⁻¹)	Feed Rate (mm/min)	a_p Axial Depth (mm)	a_e Radial Depth (mm)	Spindle Speed (min ⁻¹)	Feed Rate (mm/min)	a_p Axial Depth (mm)	a_e Radial Depth (mm)
2020	R1	3	28,000	2,900	0.3	0.7	14,000	2,100	0.15	0.5	12,250	1,800	0.08	0.35	9,200	900	0.08	0.35
		4	28,000	2,900	0.3	0.7	14,000	2,100	0.15	0.5	12,250	1,800	0.08	0.35	9,200	900	0.08	0.35
		6	28,000	2,900	0.2	0.6	14,000	2,100	0.1	0.4	12,250	1,800	0.06	0.3	9,200	900	0.06	0.3
		8	28,000	2,900	0.2	0.6	14,000	2,100	0.1	0.4	12,250	1,800	0.06	0.3	9,200	900	0.06	0.3
		10	28,000	2,900	0.2	0.6	14,000	2,100	0.1	0.4	12,250	1,800	0.06	0.3	9,200	900	0.06	0.3
		12	19,500	1,350	0.12	0.45	12,400	1,350	0.06	0.34	11,500	1,100	0.045	0.27	8,650	550	0.045	0.27
		13	19,500	1,350	0.12	0.45	12,400	1,350	0.06	0.34	11,500	1,100	0.045	0.27	8,650	550	0.045	0.27
		14	19,500	1,350	0.12	0.45	12,400	1,350	0.06	0.34	11,500	1,100	0.045	0.27	8,650	550	0.045	0.27
		16	10,800	500	0.05	0.3	10,800	600	0.03	0.24	10,700	490	0.03	0.24	8,000	245	0.03	0.24
		18	9,700	435	0.04	0.28	9,700	520	0.025	0.22	9,650	430	0.025	0.22	7,250	215	0.025	0.22
		20	8,650	375	0.035	0.25	8,650	450	0.02	0.19	8,560	370	0.02	0.19	6,400	185	0.02	0.19
		22	8,450	350	0.032	0.245	8,200	440	0.018	0.18	8,200	330	0.018	0.18	6,150	165	0.018	0.18
		25	8,250	320	0.03	0.24	7,800	440	0.016	0.16	7,800	290	0.016	0.16	5,850	145	0.016	0.16
		27	8,050	300	0.027	0.22	7,400	390	0.015	0.16	7,400	250	0.015	0.16	5,550	120	0.015	0.16
		30	7,850	280	0.024	0.2	7,000	350	0.014	0.16	7,000	220	0.014	0.16	5,250	110	0.014	0.16
		32	7,650	260	0.02	0.18	6,550	300	0.012	0.12	6,550	190	0.012	0.12	4,900	90	0.012	0.12
35	7,450	240	0.016	0.16	6,150	250	0.01	0.09	6,150	160	0.01	0.09	4,600	80	0.01	0.09		
40	7,000	200	0.01	0.06	5,250	150	0.006	0.04	5,250	100	0.006	0.04	3,950	50	0.006	0.04		
2025	R1.25	6	25,000	3,000	0.35	0.85	12,400	2,200	0.17	0.6	11,000	1,850	0.1	0.45	8,250	920	0.1	0.45
		8	25,000	3,000	0.24	0.76	12,400	2,200	0.13	0.51	11,000	1,850	0.08	0.38	8,250	920	0.08	0.38
		10	25,000	3,000	0.24	0.76	12,400	2,200	0.13	0.51	11,000	1,850	0.08	0.38	8,250	920	0.08	0.38
		15	17,300	1,400	0.145	0.57	11,000	1,400	0.08	0.44	10,300	1,140	0.06	0.35	7,700	570	0.06	0.35
		20	9,600	520	0.06	0.38	9,600	630	0.04	0.31	9,600	510	0.04	0.31	7,200	255	0.04	0.31
		25	6,900	375	0.042	0.32	6,900	450	0.024	0.235	6,840	370	0.024	0.235	5,150	185	0.024	0.235
		30	6,500	320	0.025	0.24	6,200	400	0.02	0.22	6,200	280	0.02	0.22	4,650	140	0.02	0.22
35	6,200	280	0.017	0.2	5,500	350	0.014	0.18	5,500	220	0.014	0.18	4,150	110	0.014	0.18		
2030	R1.5	6	21,000	3,000	0.4	1	10,500	2,200	0.2	0.7	9,200	1,900	0.12	0.55	6,900	950	0.12	0.55
		8	21,000	3,000	0.4	1	10,500	2,200	0.2	0.7	9,200	1,900	0.12	0.55	6,900	950	0.12	0.55
		10	21,000	3,000	0.3	0.9	10,500	2,200	0.15	0.65	9,200	1,900	0.1	0.5	6,900	950	0.1	0.5
		12	21,000	3,000	0.3	0.9	10,500	2,200	0.15	0.65	9,200	1,900	0.1	0.5	6,900	950	0.1	0.5
		14	21,000	3,000	0.3	0.9	10,500	2,200	0.15	0.65	9,200	1,900	0.1	0.5	6,900	950	0.1	0.5
		15	21,000	3,000	0.3	0.9	10,500	2,200	0.15	0.65	9,200	1,900	0.1	0.5	6,900	950	0.1	0.5
		16	21,000	3,000	0.3	0.9	10,500	2,200	0.15	0.65	9,200	1,900	0.1	0.5	6,900	950	0.1	0.5
		18	17,750	2,180	0.24	0.8	9,800	1,800	0.13	0.57	8,900	1,500	0.08	0.47	6,650	760	0.08	0.47
		20	14,500	1,360	0.18	0.7	9,250	1,400	0.1	0.5	8,600	1,150	0.075	0.45	6,450	575	0.075	0.45
		22	11,250	940	0.12	0.57	8,625	1,000	0.07	0.44	8,300	830	0.06	0.41	6,200	410	0.06	0.41
		25	8,000	520	0.07	0.45	8,000	630	0.05	0.38	8,000	510	0.05	0.38	6,000	255	0.05	0.38
		27	6,850	440	0.06	0.41	6,850	540	0.04	0.33	6,850	440	0.04	0.33	5,100	220	0.04	0.33
		30	5,750	375	0.05	0.38	5,750	450	0.03	0.29	5,700	370	0.03	0.29	4,275	185	0.03	0.29
		32	5,650	350	0.045	0.37	5,550	440	0.025	0.28	5,500	340	0.025	0.28	4,100	170	0.025	0.28
35	5,550	335	0.045	0.36	5,350	440	0.025	0.27	5,350	310	0.025	0.27	4,000	155	0.025	0.27		
40	5,350	300	0.04	0.34	4,900	390	0.02	0.24	4,850	250	0.02	0.24	3,650	125	0.02	0.24		

Ø3mm Shank
V SeriesUDC-PCD
SeriesCBN
SeriesSquare
Long Neck
Square

Radius

Long Neck
RadiusTaper Neck
RadiusBall / Long
Shank BallLong Neck
BallTaper Neck
Ball

Taper

Barrel

Spiral
V Cutter

Drill

Technical Data

Milling Conditions for HSLB / HSLB-S

WORK MATERIAL			PREHARDENED STEELS HARDENED STEELS NAK / STAVAX (~55HRC)				HARDENED STEELS SKD11 (55~62HRC)				HARDENED STEELS HAP10 (62~66HRC)				HARDENED STEELS HAP72 (66~70HRC)			
Model Number	Radius of Ball Nose (mm)	Effective Length (mm)	Spindle Speed (min ⁻¹)	Feed Rate (mm/min)	a _p Axial Depth (mm)	a _e Radial Depth (mm)	Spindle Speed (min ⁻¹)	Feed Rate (mm/min)	a _p Axial Depth (mm)	a _e Radial Depth (mm)	Spindle Speed (min ⁻¹)	Feed Rate (mm/min)	a _p Axial Depth (mm)	a _e Radial Depth (mm)	Spindle Speed (min ⁻¹)	Feed Rate (mm/min)	a _p Axial Depth (mm)	a _e Radial Depth (mm)
2035	R1.75	10	19,000	3,000	0.35	1.05	10,000	2,200	0.17	0.75	8,400	1,900	0.11	0.61	6,300	950	0.11	0.61
		15	19,000	3,000	0.35	1.05	10,000	2,200	0.17	0.75	8,400	1,900	0.11	0.61	6,300	950	0.11	0.61
		20	19,000	3,000	0.35	1.05	10,000	2,200	0.17	0.75	8,400	1,900	0.11	0.61	6,300	950	0.11	0.61
		25	13,000	1,750	0.21	0.83	8,450	1,400	0.11	0.61	7,650	1,200	0.08	0.52	5,750	600	0.08	0.52
		30	6,900	520	0.08	0.52	6,900	630	0.06	0.45	6,900	510	0.06	0.45	5,200	255	0.06	0.45
		40	5,750	410	0.06	0.45	5,550	510	0.04	0.37	5,500	380	0.04	0.37	4,150	190	0.04	0.37
		45	4,600	300	0.045	0.39	4,200	390	0.025	0.29	4,100	250	0.025	0.29	3,100	125	0.025	0.29
2040	R2	8	18,000	3,200	0.5	1.3	9,000	2,300	0.25	0.95	7,900	2,000	0.15	0.75	5,900	1,000	0.15	0.75
		10	18,000	3,200	0.5	1.3	9,000	2,300	0.25	0.95	7,900	2,000	0.15	0.75	5,900	1,000	0.15	0.75
		12	18,000	3,200	0.4	1.2	9,000	2,300	0.2	0.85	7,900	2,000	0.13	0.7	5,900	1,000	0.13	0.7
		14	18,000	3,200	0.4	1.2	9,000	2,300	0.2	0.85	7,900	2,000	0.13	0.7	5,900	1,000	0.13	0.7
		15	18,000	3,200	0.4	1.2	9,000	2,300	0.2	0.85	7,900	2,000	0.13	0.7	5,900	1,000	0.13	0.7
		16	18,000	3,200	0.4	1.2	9,000	2,300	0.2	0.85	7,900	2,000	0.13	0.7	5,900	1,000	0.13	0.7
		18	18,000	3,200	0.4	1.2	9,000	2,300	0.2	0.85	7,900	2,000	0.13	0.7	5,900	1,000	0.13	0.7
		20	18,000	3,200	0.4	1.2	9,000	2,300	0.2	0.85	7,900	2,000	0.13	0.7	5,900	1,000	0.13	0.7
		22	15,000	2,350	0.32	1.05	8,500	1,850	0.16	0.75	7,650	1,600	0.11	0.6	5,750	810	0.11	0.6
		25	12,500	1,500	0.25	0.95	8,000	1,450	0.13	0.7	7,450	1,250	0.09	0.55	5,600	625	0.09	0.55
		27	9,750	1,000	0.17	0.76	7,500	1,050	0.09	0.55	7,200	890	0.07	0.5	5,400	440	0.07	0.5
		30	7,000	550	0.1	0.6	7,000	660	0.06	0.45	7,000	540	0.06	0.45	5,250	270	0.06	0.45
		32	6,500	535	0.09	0.59	6,500	640	0.055	0.44	6,500	520	0.055	0.44	4,850	260	0.055	0.44
		35	6,000	520	0.09	0.59	6,000	630	0.055	0.43	6,000	510	0.055	0.43	4,500	255	0.055	0.43
		40	4,300	375	0.065	0.5	4,300	450	0.04	0.39	4,300	370	0.04	0.39	3,200	185	0.04	0.39
45	4,150	330	0.058	0.47	4,000	440	0.033	0.36	4,000	300	0.033	0.36	3,000	150	0.033	0.36		
50	4,000	300	0.053	0.44	3,750	400	0.03	0.33	3,750	260	0.03	0.33	2,800	130	0.03	0.33		
60	3,900	280	0.048	0.4	3,500	350	0.028	0.3	3,500	220	0.028	0.3	2,600	110	0.028	0.3		
2050	R2.5	10	14,400	3,200	0.5	1.5	7,200	2,300	0.25	1.05	6,350	2,000	0.16	0.88	4,750	1,000	0.16	0.88
		15	14,400	3,200	0.5	1.5	7,200	2,300	0.25	1.05	6,350	2,000	0.16	0.88	4,750	1,000	0.16	0.88
		20	14,400	3,200	0.5	1.5	7,200	2,300	0.25	1.05	6,350	2,000	0.16	0.88	4,750	1,000	0.16	0.88
		25	12,200	2,350	0.405	1.35	6,800	1,850	0.205	0.95	6,250	1,600	0.135	0.805	4,650	800	0.135	0.805
		30	10,000	1,500	0.31	1.2	6,400	1,450	0.16	0.88	6,200	1,250	0.11	0.73	4,650	625	0.11	0.73
		35	8,000	1,050	0.21	1	6,200	1,070	0.12	0.76	6,100	900	0.095	0.68	4,600	450	0.095	0.68
		40	6,000	570	0.125	0.78	6,000	690	0.08	0.625	6,000	570	0.08	0.625	4,500	285	0.08	0.625
		45	5,150	500	0.11	0.72	5,150	600	0.07	0.4	5,100	500	0.07	0.4	3,800	250	0.07	0.4
		50	4,300	430	0.09	0.65	4,300	510	0.06	0.18	4,200	435	0.06	0.18	3,150	215	0.06	0.18

φ3mm Shank V Series

UDC-PCD Series

CBN Series

Square

Long Neck Square

Radius

Long Neck Radius

Taper Neck Radius

Ball / Long Shank Ball

Long Neck Ball

Taper Neck Ball

Taper

Barrel

Spiral V Cutter

Drill

Technical Data

Milling Conditions for HSLB / HSLB-S

WORK MATERIAL			PREHARDENED STEELS HARDENED STEELS NAK / STAVAX (~55HRC)				HARDENED STEELS SKD11 (55~62HRC)				HARDENED STEELS HAP10 (62~66HRC)				HARDENED STEELS HAP72 (66~70HRC)			
Model Number	Radius of Ball Nose (mm)	Effective Length (mm)	Spindle Speed (min ⁻¹)	Feed Rate (mm/min)	a_p Axial Depth (mm)	a_e Radial Depth (mm)	Spindle Speed (min ⁻¹)	Feed Rate (mm/min)	a_p Axial Depth (mm)	a_e Radial Depth (mm)	Spindle Speed (min ⁻¹)	Feed Rate (mm/min)	a_p Axial Depth (mm)	a_e Radial Depth (mm)	Spindle Speed (min ⁻¹)	Feed Rate (mm/min)	a_p Axial Depth (mm)	a_e Radial Depth (mm)
2060	R3	10	13,000	3,500	0.6	1.8	6,500	2,500	0.3	1.3	5,700	2,200	0.2	1	4,300	1,100	0.2	1
		15	13,000	3,500	0.6	1.8	6,500	2,500	0.3	1.3	5,700	2,200	0.2	1	4,300	1,100	0.2	1
		18	13,000	3,500	0.6	1.8	6,500	2,500	0.3	1.3	5,700	2,200	0.2	1	4,300	1,100	0.2	1
		20	13,000	3,500	0.6	1.8	6,500	2,500	0.3	1.3	5,700	2,200	0.2	1	4,300	1,100	0.2	1
		22	13,000	3,500	0.6	1.8	6,500	2,500	0.3	1.3	5,700	2,200	0.2	1	4,300	1,100	0.2	1
		25	13,000	3,500	0.6	1.8	6,500	2,500	0.3	1.3	5,700	2,200	0.2	1	4,300	1,100	0.2	1
		27	13,000	3,500	0.6	1.8	6,500	2,500	0.3	1.3	5,700	2,200	0.2	1	4,300	1,100	0.2	1
		30	13,000	3,500	0.6	1.8	6,500	2,500	0.3	1.3	5,700	2,200	0.2	1	4,300	1,100	0.2	1
		32	12,000	3,100	0.54	1.7	6,300	2,250	0.27	1.15	5,600	2,000	0.18	0.9	4,200	1,000	0.18	0.9
		35	11,000	2,750	0.48	1.6	6,100	2,050	0.25	1.05	5,500	1,800	0.175	0.8	4,150	900	0.175	0.8
		40	9,000	2,050	0.375	1.35	5,750	1,600	0.2	0.8	5,350	1,400	0.15	0.65	4,000	700	0.15	0.65
		45	7,000	1,300	0.26	1.1	5,350	1,150	0.15	0.55	5,150	1,000	0.125	0.45	3,850	500	0.125	0.45
50	5,000	600	0.15	0.9	5,000	720	0.1	0.3	5,000	600	0.1	0.3	3,750	300	0.1	0.3		
60	3,600	430	0.105	0.75	3,600	510	0.08	0.22	3,550	435	0.08	0.22	2,650	215	0.08	0.22		

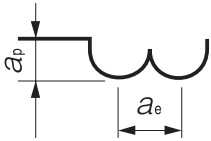

- Note:
- Decrease the feed rate more than 50% from the milling parameters when slot milling.
 - Decrease both spindle speed and feed rate proportionally when the milling parameters exceed the machine's maximum speed, or when the tool is chattering and heats up to a red color.
 - Every coolant offers stable milling.

Ø3mm Shank
V Series

UDC-PCD
Series

CBN
Series

Square

Long Neck
Square

Radius

Long Neck
Radius

Taper Neck
Radius

Ball / Long
Shank Ball

Long Neck
Ball

Taper Neck
Ball

Taper

Barrel

Spiral
V Cutter

Drill

Technical Data



Size R0.1~R3

Short Shank Series

HSLB-S



Back taper geometry does not apply to R0.4 or below, and $\ell_1 / D \leq 10$.

Material Applications (★ Highly Recommended ● Recommended ○ Suggested)

Work Material																	
Carbon Steels S45C S55C	Alloy Steels SK / SCM SUS	Prehardened Steels NAK HPM	Hardened Steels					Cast Iron	Aluminum Alloys	Graphite	Copper	Plastics	Glass Filled Plastics	Titanium Alloys	Heat Resistant Alloys	Cemented Carbide	Hard Brittle (Non-Metallic) Materials
			~ 50HRC	~ 55HRC	~ 60HRC	~ 65HRC	~ 70HRC										
○	○	●	●	●	●	○	○			○				○	○		

Features

- 1 Short shank for high accuracy shrink-fit holder.
- 2 Variable rake angle design Optimized rake angles are designed from the ball tip to the peripheral cutting edge.
- 3 HARDMAX Coating HARDMAX coating offers heat resistance, durability and lubricity at a high level.
- 4 Suitable for various coolant types. Every coolant offers stable milling.

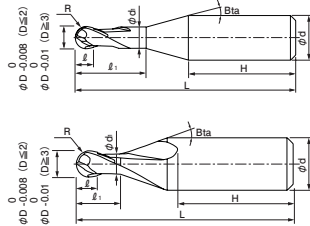

The shank taper angle shown is not an exact value and to avoid contact with the work piece, we recommend the user controls the precise value of this angle. Shank taper angle should not make contact with the work piece.

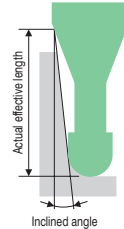

Short overhang length with short shank length!

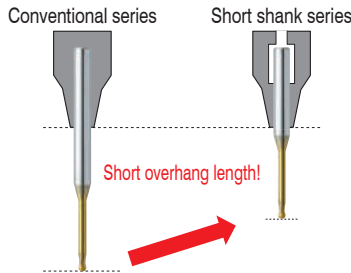

Short overhang length minimizes tool run-out

- High precision milling
- Minimizes chattering
- Longer tool life

Ideal for tool holders where the maximum insertion is short.

Tighter Tolerance Design! Diameter Tolerance, Ball Radius Accuracy, and Shank Diameter Tolerance

HSB / HSLB Tolerance

Radius of Ball Nose	Diameter Tolerance	Ball Radius Accuracy	Shank Diameter Tolerance
R0.1 ~ R3	0/-0.015	±0.005	0/-0.005 (h5)

HSB-S / HSLB-S Tolerance

Radius of Ball Nose	Diameter Tolerance	Ball Radius Accuracy	Shank Diameter Tolerance
R0.1 ~ R1	0/-0.008	±0.003	0/-0.004 (h4)
R1.5 ~ R2	0/-0.01		
R3		±0.005	

Shank diameter tolerance h4!

Total 61 models

Unit (mm)

Model Number	Radius of Ball Nose R	Effective Length l_1	Length of Cut l	Neck Diameter ϕd_1	Shank Taper Angle β	Overall Length L	Shank Diameter ϕd	Shank Length H	Suggested Retail Price ¥	Effective Length by Inclined Angles				
										30°	1°	1°30'	2°	3°
HSLB 2002-005S	RO.1	0.5	0.16	0.19	16°	35	4	26.0	6,470	0.63	0.66	0.68	0.71	0.76
HSLB 2002-010S		1				35	4	25.5	6,470	1.15	1.20	1.24	1.28	1.37
HSLB 2003-005S	RO.15	0.5	0.24	0.29	16°	35	4	26.0	6,380	0.63	0.65	0.68	0.70	0.75
HSLB 2003-0075S		0.75				35	4	26.0	6,380	0.89	0.92	0.96	0.99	1.05
HSLB 2003-010S		1				35	4	25.5	6,380	1.15	1.19	1.23	1.27	1.36
HSLB 2003-015S		1.5				35	4	25.0	6,840	1.66	1.72	1.77	1.83	1.96
HSLB 2004-005S	RO.2	0.5	0.32	0.39	16°	35	4	26.5	4,380	0.63	0.65	0.67	0.70	0.74
HSLB 2004-010S		1				35	4	26.0	4,380	1.15	1.19	1.23	1.26	1.35
HSLB 2004-015S		1.5				35	4	25.5	4,470	1.66	1.71	1.77	1.82	1.95
HSLB 2004-020S		2				35	4	25.0	4,560	2.18	2.25	2.32	2.39	2.56
HSLB 2004-025S		2.5				35	4	24.5	4,740	2.70	2.78	2.87	2.96	3.17
HSLB 2004-030S		3				35	4	24.0	5,020	3.21	3.31	3.42	3.53	3.79
HSLB 2005-010S	RO.25	1	0.4	0.49	16°	35	4	26.0	4,380	1.15	1.19	1.22	1.26	1.34
HSLB 2005-015S		1.5				35	4	25.5	4,380	1.65	1.71	1.76	1.82	1.94
HSLB 2005-020S		2				35	4	25.0	4,380	2.18	2.24	2.31	2.39	2.55
HSLB 2005-025S		2.5				35	4	24.5	4,380	2.69	2.78	2.86	2.96	3.16
HSLB 2005-030S		3				35	4	24.0	4,380	3.21	3.31	3.41	3.53	3.77
HSLB 2006-010S	RO.3	1	0.48	0.59	16°	35	4	26.0	3,740	1.14	1.18	1.22	1.25	1.33
HSLB 2006-015S		1.5				35	4	25.5	3,380	1.65	1.71	1.76	1.81	1.93
HSLB 2006-020S		2				35	4	25.0	3,380	2.17	2.24	2.31	2.38	2.54
HSLB 2006-030S		3				35	4	24.0	3,460	3.21	3.31	3.41	3.52	3.76
HSLB 2006-040S		4				40	4	28.0	3,560	4.24	4.37	4.51	4.66	4.99
HSLB 2006-050S		5				40	4	27.0	3,560	5.27	5.44	5.61	5.80	6.21
HSLB 2006-060S		6				40	4	26.0	3,560	6.30	6.50	6.71	6.93	7.43
HSLB 2008-020S	RO.4	2	0.64	0.79	16°	35	4	25.5	3,380	2.17	2.23	2.30	2.37	2.52
HSLB 2008-030S		3				35	4	24.5	3,560	3.21	3.30	3.40	3.50	3.74
HSLB 2008-040S		4				35	4	23.5	3,560	4.24	4.36	4.50	4.64	4.97
HSLB 2008-060S		6				40	4	26.5	3,560	6.30	6.49	6.70	6.92	7.41
HSLB 2010-020S	RO.5	2	0.8	0.98	16°	35	4	25.5	2,820	2.18	2.24	2.30	2.36	2.51
HSLB 2010-025S		2.5				35	4	25.0	2,820	2.70	2.77	2.85	2.93	3.12
HSLB 2010-030S		3				35	4	24.5	2,820	3.21	3.30	3.40	3.50	3.73
HSLB 2010-040S		4				35	4	23.5	3,190	4.24	4.37	4.50	4.64	4.96
HSLB 2010-060S		6				40	4	26.5	3,460	6.31	6.50	6.70	6.92	7.40
HSLB 2010-080S		8				40	4	24.5	3,460	8.37	8.63	8.90	9.20	9.85
HSLB 2015-030S	RO.75	3	1.2	1.47	16°	35	4	25.5	3,280	3.10	3.18	3.26	3.35	3.55
HSLB 2015-040S		4				35	4	24.5	3,280	4.13	4.24	4.36	4.49	4.77
HSLB 2015-060S		6				40	4	27.5	3,280	6.19	6.37	6.56	6.76	7.22
HSLB 2015-080S		8				40	4	25.5	3,460	8.25	8.50	8.76	9.04	9.67
HSLB 2015-100S		10				40	4	23.5	3,740	10.32	10.63	10.96	11.32	12.11

Next Page →

3mm Shank
V Series

UDC-PCD
Series

CBN
Series

Square
Long Neck
Square

Radius
Long Neck
Radius
Taper Neck
Radius

Ball / Long
Shank Ball
Long Neck
Ball
Taper Neck
Ball

Taper
Taper

Barrel

Spiral
V Cutter

Drill

Technical Data

Unit (mm)

Model Number	Radius of Ball Nose R	Effective Length ℓ_1	Length of Cut ℓ	Neck Diameter ϕd_1	Shank Taper Angle Bia	Overall Length L	Shank Diameter ϕd	Shank Length H	Suggested Retail Price ¥	Effective Length by Inclined Angles				
										30°	1°	1°30'	2°	3°
HSLB 2020-030S	R1	3	1.6	1.98	16°	35	4	26.5	2,820	3.07	3.14	3.21	3.29	3.47
HSLB 2020-040S		4				35	4	25.5	2,820	4.10	4.20	4.31	4.43	4.70
HSLB 2020-060S		6				35	4	23.5	3,190	6.16	6.33	6.51	6.71	7.14
HSLB 2020-080S		8				40	4	26.5	3,460	8.23	8.46	8.72	8.99	9.59
HSLB 2020-100S		10				40	4	24.5	3,460	10.29	10.59	10.92	11.26	12.04
HSLB 2020-120S		12				45	4	27.5	3,460	12.35	12.72	13.12	13.54	14.48
HSLB 2020-140S		14				45	4	25.5	3,460	14.41	14.85	15.32	15.82	16.93
HSLB 2020-160S		16				50	4	28.5	3,460	16.48	16.98	17.52	18.10	19.38
HSLB 2020-200S		20				50	4	24.5	3,460	20.60	21.24	21.92	22.65	No Interference
HSLB 2030-060-4S		R1.5				6	2.4	2.95	16°	35	4	25.0	3,460	6.20
HSLB 2030-080-4S	8		40	4	28.0	3,460				8.26	8.48	8.72	8.97	9.54
HSLB 2030-100-4S	10		40	4	26.0	4,020				10.32	10.61	10.92	11.25	No Interference
HSLB 2030-120-4S	12		40	4	24.0	4,190				12.38	12.74	13.12	13.53	No Interference
HSLB 2030-160-4S	16		45	4	25.0	4,650				16.51	17.00	17.52	No Interference	No Interference
HSLB 2030-200-4S	20		50	4	26.0	4,470				20.64	21.26	No Interference	No Interference	No Interference
HSLB 2040-080-4S	R2	8	3.2	3.95	—	35	4	24.0	3,560	No Interference	No Interference	No Interference	No Interference	No Interference
HSLB 2040-100-4S		10				40	4	28.0	3,560	No Interference	No Interference	No Interference	No Interference	No Interference
HSLB 2040-120-4S		12				40	4	26.0	4,650	No Interference	No Interference	No Interference	No Interference	No Interference
HSLB 2040-160-4S		16				45	4	27.0	4,650	No Interference	No Interference	No Interference	No Interference	No Interference
HSLB 2040-200-4S		20				50	4	28.0	4,650	No Interference	No Interference	No Interference	No Interference	No Interference
HSLB 2060-150S	R3	15	4.8	5.95	—	45	6	28.0	5,840	No Interference	No Interference	No Interference	No Interference	No Interference
HSLB 2060-200S		20				50	6	28.0	5,840	No Interference	No Interference	No Interference	No Interference	No Interference

φ3mm Shank V Series

UDC-PCD Series

CBN Series

Square
Long Neck Square

Radius
Long Neck Radius

Taper Neck Radius

Ball / Long Shank Ball
Long Neck Ball
Taper Neck Ball

Taper

Barrel

Spiral V Cutter

Drill

Technical Data

Milling examples

SKH51 (63HRC)

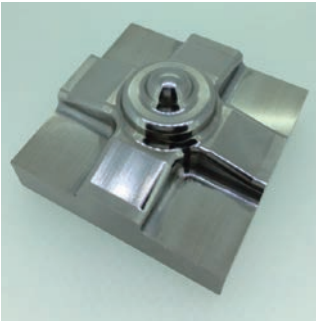

Size : 50 x 50 x 30 mm

No.	Process	Tool	Spindle Speed (min ⁻¹)	Feed Rate (mm/min)	a _p (mm)	a _e (mm)	Cycle Time (h:m:s)
1	Roughing	HMS φ 10 × L22	2,000	1,000	17.5	0.2	0:59:48
2	Semi-roughing	HSB R3	5,700	2,200	0.2	0.3	0:37:55
3	Semi-roughing	HSLB R2 × EL8	7,900	2,000	0.15	0.3	0:05:44
4	Finishing	HLRS φ 6 × CR0.1 × EL12	4,000	1,080	—	1.35	1:38:31
5	Semi-finishing	HSLB R2 × EL8	7,900	1,000	0.04	0.04	0:04:08
6	Finishing	HSLB R1.75 × EL10	16,800	920	0.04	0.04	2:26:27
7	Finishing	HSLB R1 × EL3	12,250	900	0.03	0.03	0:11:17
Total							6:03:50

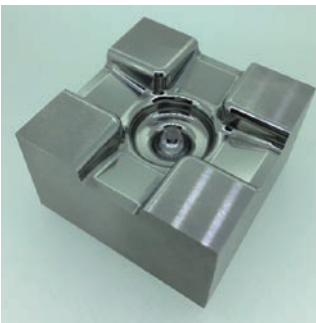

Size : 50 x 50 x 30 mm

No.	Process	Tool	Spindle Speed (min ⁻¹)	Feed Rate (mm/min)	a _p (mm)	a _e (mm)	Cycle Time (h:m:s)
1	Roughing	HSB R5	3,750	1,750	0.3	1.7	0:35:28
2	Semi-roughing	HSB R3	5,700	2,200	0.2	0.3	0:29:29
3	Semi-roughing	HSLB R2 × EL8	7,900	2,000	0.15	0.3	0:20:42
4	Semi-finishing	HSLB R2 × EL8	7,900	1,000	0.04	0.04	1:30:26
5	Semi-finishing	HSLB R1.75 × EL10	8,400	920	—	—	0:34:04
6	Finishing	HSLB R1.75 × EL10	16,800	920	0.04	0.04	2:17:59
7	Finishing	HSLB R1 × EL3	12,250	900	0.03	0.03	0:08:02
Total							5:56:10

- Coolant : Air blow, Oil Mist
- R1.75 Surface roughness : Ra 0.10 ~ 0.24 μm (Ave 0.17 μm)

Surface condition by different milling conditions R1.75 × EL10



	Milling condition A	Milling condition B	Milling condition C	Milling condition D	Milling condition E
Spindle Speed (min ⁻¹)	8,400				16,800
Feed Rate (mm/min)	1,900	1,390	1,230	920	920
a _p , a _e (mm)	0.04	0.04	0.04	0.04	0.04
Feed per tooth (mm/t)	0.11	0.083	0.073	0.055	0.027
Feed rate ratio	100%	75%	66%	50%	50%

※ A is based on the catalog milling conditions.

Milling condition A	Milling condition B	Milling condition C	Milling condition D Good	Milling condition E Excellent

Test A ~ D) Compared milling surfaces with 4 different feed rates and the spindle speed of 8,400 min⁻¹.

Result . . . The milling surface improved with reduced feed per tooth.

Test E) Tested with the double spindle speed of 16,800 min⁻¹.

Result . . . The milling surface improved even more (Ra 0.17 μm) with increased spindle speed.

Milling condition E was applied to another work.

φ3mm Shank
V Series

UDC-PCD
Series

CBN
Series

Square
Long Neck
Square

Radius
Long Neck
Radius

Taper Neck
Radius

Ball / Long
Shank Ball
Long Neck
Ball

Taper Neck
Ball

Taper

Barrel

Spiral
V Cutter

Drill

Technical Data



Size R0.05~R3

CSELB

Super
MG

UT
COAT

Shank Dia
0/-0.005

Back Taper
Geometry

Material Applications (★ Highly Recommended ● Recommended ○ Suggested)

Work Material																	
Carbon Steels	Alloy Steels	Prehardened Steels	Hardened Steels					Cast Iron	Aluminum Alloys	Graphite	Copper	Plastics	Glass Filled Plastics	Titanium Alloys	Heat Resistant Alloys	Cemented Carbide	Hard Brittle (Non-Metallic) Materials
S45C	SK / SCM	NAK	~ 50HRC	~ 55HRC	~ 60HRC	~ 65HRC	~ 70HRC										
S55C	SUS	HPM															
●	●	●	●	●					○	●	●				○	○	

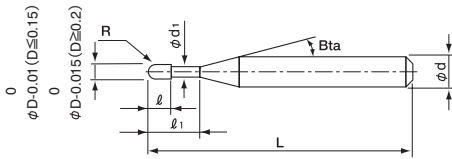

The shank taper angle shown is not an exact value and to avoid contact with the work piece, we recommend the user controls the precise value of this angle. Shank taper angle should not make contact with the work piece.

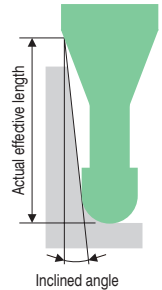

Radius of Ball Nose	Diameter Tolerance	Ball Radius Accuracy	Helix Angle
R0.05 ~ R0.075	0/-0.01	±0.002	0°
R0.1 ~ R3	0/-0.015	±0.005	30°

3 features of CSELB

Reduce cutting resistance and prioritize surface quality.

Recommended for milling on hardened steels (55HRC) - sticky materials, materials that prone to chatter marks.

Less resistance on curved surface shape

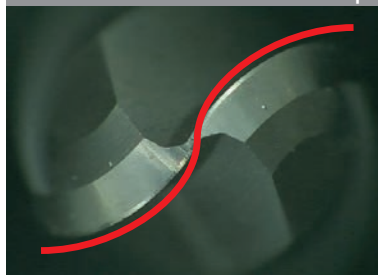

Small relief surface



Tip design with excellent cutting performance



Wheel shape

PX5 (30HRC)

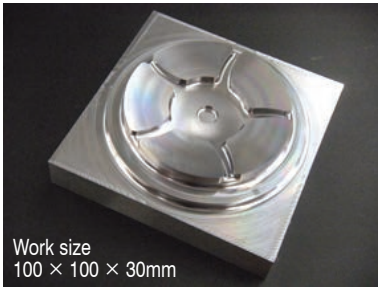

Work size
100 × 100 × 30mm

Coolant: Water soluble

Tool

2 flute ball
CSEB (P432)



2 flute long neck ball
CSELB



4 flute highly efficient radius
CRRS (P390)



No	Process	Tool	Spindle Speed (min ⁻¹)	Feed Rate (mm/min)	a_p (mm)	a_e (mm)	Allowance (mm)	Cycle Time (h:m:s)
1	Roughing	CSEB R3	11,000	2,300	0.55	1.7	0.1	0:56:56
2		CSELB R2 × EL12	18,000	2,400	0.4	1.2	0.03	0:00:43
3	Semi-finishing	CSELB R2 × EL12	18,000	3,000	0.18	—	0.03	0:13:08
4					0.2	—	0.03	0:01:54
5		—	0.12	0.03	0:18:57			
6		CSELB R1 × EL8	30,000	2,000	0.1	0.1	0.03	0:17:26
No	Process	Tool	Spindle Speed (min ⁻¹)	Feed Rate (mm/min)	a_p (mm)	a_e (mm)	Allowance (mm)	Cycle Time (h:m:s)
7	Finishing	CRRS ϕ 6 × CR1	8,000	1,000	0.05	1	0	0:14:00
8		CSELB R1 × EL8	30,000	2,000	0.04	—	—	2:31:37
9					0.04	—	—	0:16:16
10		—	0.03	—	—	0:59:37		
11		0.04	0.04	—	—	0:02:11		

Total 5:52:45

Measurement of finishing roughness

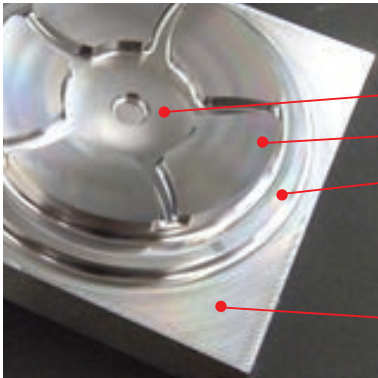
**CSELB Long neck ball R1 × EL8**

Canter	Ra 0.396
Radius	Ra 0.421
Side	Ra 0.118

CRRS 4 flute highly efficient radius ϕ 6 × CR1

Flat surface	Ra 0.091
--------------	----------

Finishing with CSEB/CSELB offers uniform milling surface.

ϕ 3mm Shank
V Series

UDC-PCD
Series

CBN
Series

Square

Square
Long Neck
Square

Radius

Radius
Long Neck
Radius

Ball

Taper Neck
Radius
Ball / Long
Shank Ball

Ball

Long Neck
Ball
Taper Neck
Ball

Taper

Taper

Barrel

Barrel

Spiral
V Cutter

Spiral
V Cutter

Drill

Drill

Technical Data

Technical Data

Total 325 models

Unit (mm)

Model Number	Radius of Ball Nose R	Effective Length l_1	Length of Cut l	Neck Diameter ϕd_1	Shank Taper Angle Bia	Overall Length L	Shank Diameter ϕd	Suggested Retail Price ¥	Effective Length by Inclined Angles								
									30°	1°	1°30'	2°	3°				
CSELB 2001-002	RO.05	0.2	0.08	0.095	11°	45	4	11,630	0.22	0.24	0.26	0.28	0.31				
CSELB 2001-003		0.3				45	4	11,630	0.33	0.35	0.38	0.40	0.45				
CSELB 2001-005		0.5				45	4	12,540	0.54	0.58	0.61	0.64	0.72				
CSELB 20015-003	RO.075	0.3	0.12	0.135	11°	45	4	13,450	0.36	0.38	0.40	0.42	0.48				
CSELB 20015-005		0.5				45	4	14,250	0.58	0.60	0.63	0.67	0.75				
CSELB 20015-010		1				45	4	14,820	1.10	1.15	1.21	1.28	1.43				
CSELB 2002-003	RO.1	0.3	0.16	0.19	11°	45	4	8,090	0.40	0.42	0.44	0.46	0.52				
CSELB 2002-005		0.5				45	4	8,090	0.61	0.64	0.67	0.71	0.79				
CSELB 2002-005-6		0.5				50	6	11,290	0.61	0.64	0.67	0.71	0.79				
CSELB 2002-0075		0.75				45	4	8,090	0.87	0.92	0.96	1.01	1.13				
CSELB 2002-010		1				45	4	8,090	1.14	1.19	1.25	1.32	1.48				
CSELB 2002-010-6		1				50	6	11,290	1.14	1.19	1.25	1.32	1.48				
CSELB 2002-0125		1.25				45	4	8,780	1.39	1.45	1.53	1.61	1.80				
CSELB 2002-015		1.5				45	4	8,780	1.65	1.73	1.81	1.91	2.14				
CSELB 2002-015-6		1.5				50	6	12,250	1.65	1.73	1.81	1.91	2.14				
CSELB 2002-0175		1.75				45	4	9,690	1.91	2.00	2.10	2.22	2.49				
CSELB 2002-020		2				45	4	9,690	2.17	2.28	2.39	2.52	2.83				
CSELB 2002-020-6		2				50	6	13,520	2.17	2.28	2.39	2.52	2.83				
CSELB 2002-0225		2.25				45	4	10,600	2.43	2.55	2.68	2.83	3.17				
CSELB 2002-025		2.5				45	4	10,600	2.69	2.83	2.97	3.13	3.51				
CSELB 2002-030		3				45	4	11,400	3.22	3.37	3.55	3.74	4.20				
CSELB 2003-005		RO.15				0.5	0.24	0.29	11°	45	4	7,980	0.61	0.64	0.67	0.70	0.77
CSELB 2003-006						0.6				45	4	7,980	0.71	0.75	0.78	0.82	0.91
CSELB 2003-0075						0.75				45	4	7,980	0.87	0.91	0.95	1.00	1.12
CSELB 2003-010						1				45	4	7,980	1.13	1.19	1.24	1.31	1.46
CSELB 2003-010-6						1				50	6	10,830	1.13	1.19	1.24	1.31	1.46
CSELB 2003-0125	1.25		45	4	8,550	1.38				1.45	1.52	1.60	1.78				
CSELB 2003-015	1.5		45	4	8,550	1.64				1.72	1.81	1.90	2.12				
CSELB 2003-015-6	1.5		50	6	11,860	1.64				1.72	1.81	1.90	2.12				
CSELB 2003-0175	1.75		45	4	8,550	1.91				2.00	2.10	2.21	2.47				
CSELB 2003-020	2		45	4	8,550	2.17				2.27	2.38	2.51	2.81				
CSELB 2003-020-6	2		50	6	11,860	2.17				2.27	2.38	2.51	2.81				
CSELB 2003-0225	2.25		45	4	8,780	2.43				2.55	2.67	2.82	3.15				
CSELB 2003-025	2.5		45	4	8,780	2.69				2.82	2.96	3.12	3.49				
CSELB 2003-030	3		45	4	8,780	3.22				3.37	3.54	3.73	4.18				
CSELB 2003-040	4		45	4	9,120	4.26				4.47	4.70	4.95	5.55				
CSELB 2003-050	5		45	4	10,260	5.31				5.57	5.85	6.17	6.92				

Next Page ➔

- Ø3mm Shank V Series
- UDC-PCD Series
- CBN Series
- Square
- Long Neck Square
- Radius
- Long Neck Radius
- Taper Neck Radius
- Ball / Long Shank Ball
- Long Neck Ball
- Taper Neck Ball
- Taper
- Barrel
- Spiral V Cutter
- Drill
- Technical Data

Unit (mm)

Model Number	Radius of Ball Nose R	Effective Length l_e	Length of Cut l	Neck Diameter ϕd	Shank Taper Angle Bta	Overall Length L	Shank Diameter ϕd	Suggested Retail Price ¥	Effective Length by Inclined Angles				
									30°	1°	1°30'	2°	3°
CSELB 2004-005	RO.2	0.5	0.32	0.39	11°	45	4	5,470	0.61	0.63	0.66	0.69	0.76
CSELB 2004-0075		0.75				45	4	5,470	0.87	0.91	0.95	0.99	1.10
CSELB 2004-010		1				45	4	5,470	1.13	1.18	1.24	1.30	1.44
CSELB 2004-010-6		1				50	6	7,980	1.13	1.18	1.24	1.30	1.44
CSELB 2004-0125		1.25				45	4	5,590	1.38	1.44	1.51	1.59	1.76
CSELB 2004-015		1.5				45	4	5,590	1.64	1.72	1.80	1.89	2.11
CSELB 2004-015-6		1.5				50	6	8,090	1.64	1.72	1.80	1.89	2.11
CSELB 2004-0175		1.75				45	4	5,700	1.90	1.99	2.09	2.19	2.45
CSELB 2004-020		2				45	4	5,700	2.17	2.27	2.38	2.50	2.79
CSELB 2004-020-6		2				50	6	8,320	2.17	2.27	2.38	2.50	2.79
CSELB 2004-0225		2.25				45	4	5,930	2.43	2.54	2.67	2.80	3.13
CSELB 2004-025		2.5				45	4	5,930	2.69	2.82	2.95	3.11	3.48
CSELB 2004-025-6		2.5				50	6	8,550	2.69	2.82	2.95	3.11	3.48
CSELB 2004-030		3				45	4	6,270	3.21	3.36	3.53	3.72	4.16
CSELB 2004-030-6		3				50	6	9,120	3.21	3.36	3.53	3.72	4.16
CSELB 2004-035		3.5				45	4	6,840	3.74	3.91	4.11	4.33	4.85
CSELB 2004-040		4				45	4	6,840	4.26	4.46	4.69	4.94	5.53
CSELB 2004-040-6		4				50	6	9,300	4.26	4.46	4.69	4.94	5.53
CSELB 2004-045		4.5				45	4	7,180	4.78	5.01	5.27	5.55	6.21
CSELB 2004-050		5				45	4	7,180	5.31	5.56	5.84	6.16	6.90
CSELB 2004-060	6	45	4	8,320	6.35	6.66	7.00	7.38	8.27				
CSELB 2005-010	RO.25	1	0.4	0.49	11°	45	4	5,470	1.13	1.17	1.23	1.28	1.42
CSELB 2005-0125		1.25				45	4	5,470	1.38	1.43	1.50	1.57	1.74
CSELB 2005-015		1.5				45	4	5,470	1.64	1.71	1.79	1.88	2.09
CSELB 2005-015-6		1.5				50	6	7,980	1.64	1.71	1.79	1.88	2.09
CSELB 2005-0175		1.75				45	4	5,470	1.90	1.98	2.08	2.18	2.43
CSELB 2005-020		2				45	4	5,470	2.16	2.26	2.37	2.49	2.77
CSELB 2005-020-6		2				50	6	7,980	2.16	2.26	2.37	2.49	2.77
CSELB 2005-0225		2.25				45	4	5,470	2.42	2.53	2.65	2.79	3.11
CSELB 2005-025		2.5				45	4	5,470	2.68	2.81	2.94	3.10	3.45
CSELB 2005-025-6		2.5				50	6	7,980	2.68	2.81	2.94	3.10	3.45
CSELB 2005-030		3				45	4	5,470	3.21	3.36	3.52	3.70	4.14
CSELB 2005-030-6		3				50	6	7,980	3.21	3.36	3.52	3.70	4.14
CSELB 2005-035		3.5				45	4	5,470	3.73	3.91	4.10	4.31	4.82
CSELB 2005-040		4				45	4	5,470	4.25	4.46	4.68	4.92	5.51
CSELB 2005-040-6		4				50	6	7,980	4.25	4.46	4.68	4.92	5.51
CSELB 2005-045		4.5				45	4	5,590	4.78	5.00	5.26	5.53	6.19
CSELB 2005-050		5				45	4	5,590	5.30	5.55	5.83	6.14	6.88
CSELB 2005-055		5.5				45	4	5,700	5.83	6.10	6.41	6.75	7.56
CSELB 2005-060		6				45	4	5,700	6.35	6.65	6.99	7.36	8.25
CSELB 2005-070		7				45	4	6,840	7.40	7.75	8.14	8.58	9.62
CSELB 2005-080	8	45	4	6,840	8.44	8.85	9.30	9.80	10.99				
CSELB 2005-090	9	45	4	7,980	9.49	9.95	10.46	11.02	12.35				
CSELB 2005-100	10	50	4	8,500	10.54	11.05	11.61	12.24	13.72				

- Ø3mm Shank V Series
- UDC-PCD Series
- CBN Series
- Square
- Square
- Long Neck Square
- Radius
- Radius
- Long Neck Radius
- Taper Neck Radius
- Ball / Long Shank Ball
- Ball
- Long Neck Ball
- Taper Neck Ball
- Taper
- Taper
- Barrel
- Spiral V Cutter
- Drill
- Technical Data

Model Number	Radius of Ball Nose R	Effective Length l_1	Length of Cut l	Neck Diameter ϕd_1	Shank Taper Angle Bia	Overall Length L	Shank Diameter ϕd	Suggested Retail Price ¥	Effective Length by Inclined Angles				
									30°	1°	1°30'	2°	3°
CSELB 2006-010	R0.3	1	0.48	0.59	11°	45	4	4,670	1.12	1.17	1.22	1.27	1.40
CSELB 2006-0125		1.25				45	4	4,220	1.37	1.43	1.49	1.56	1.73
CSELB 2006-015		1.5				45	4	4,220	1.63	1.70	1.78	1.87	2.07
CSELB 2006-015-6		1.5				50	6	6,380	1.63	1.70	1.78	1.87	2.07
CSELB 2006-0175		1.75				45	4	4,220	1.90	1.98	2.07	2.17	2.41
CSELB 2006-020		2				45	4	4,220	2.16	2.25	2.36	2.48	2.75
CSELB 2006-020-6		2				50	6	6,380	2.16	2.25	2.36	2.48	2.75
CSELB 2006-0225		2.25				45	4	4,330	2.42	2.53	2.65	2.78	3.09
CSELB 2006-025		2.5				45	4	4,330	2.68	2.80	2.94	3.08	3.44
CSELB 2006-025-6		2.5				50	6	6,380	2.68	2.80	2.94	3.08	3.44
CSELB 2006-030		3				45	4	4,330	3.21	3.35	3.51	3.69	4.12
CSELB 2006-030-6		3				50	6	6,500	3.21	3.35	3.51	3.69	4.12
CSELB 2006-035		3.5				45	4	4,450	3.73	3.90	4.09	4.30	4.81
CSELB 2006-040		4				45	4	4,450	4.25	4.45	4.67	4.91	5.49
CSELB 2006-040-6		4				50	6	6,730	4.25	4.45	4.67	4.91	5.49
CSELB 2006-045		4.5				45	4	4,450	4.78	5.00	5.25	5.52	6.18
CSELB 2006-050		5				45	4	4,450	5.30	5.55	5.83	6.13	6.86
CSELB 2006-050-6		5				50	6	6,730	5.30	5.55	5.83	6.13	6.86
CSELB 2006-055		5.5				45	4	4,450	5.82	6.10	6.40	6.74	7.54
CSELB 2006-060		6				45	4	4,450	6.35	6.65	6.98	7.35	8.23
CSELB 2006-060-6	6	50	6	6,730	6.35	6.65	6.98	7.35	8.23				
CSELB 2006-065	6.5	45	4	5,020	6.87	7.20	7.56	7.96	8.91				
CSELB 2006-070	7	45	4	5,020	7.39	7.75	8.14	8.57	9.60				
CSELB 2006-080	8	45	4	5,930	8.44	8.85	9.29	9.79	10.97				
CSELB 2006-080-6	8	50	6	8,550	8.44	8.85	9.29	9.79	10.97				
CSELB 2006-090	9	45	4	6,270	9.49	9.94	10.45	11.01	12.34				
CSELB 2006-100	10	50	4	6,040	10.53	11.04	11.60	12.23	13.71				
CSELB 2006-100-6	10	50	6	9,120	10.53	11.04	11.60	12.23	13.71				
CSELB 2006-120	12	50	4	6,840	12.63	13.24	13.92	14.66	16.44				
CSELB 2007-020	R0.35	2	0.56	0.69	11°	45	4	4,220	2.16	2.25	2.35	2.46	2.73
CSELB 2007-040		4				45	4	4,450	4.25	4.45	4.66	4.90	5.47
CSELB 2007-060		6				45	4	4,450	6.34	6.64	6.97	7.34	8.21
CSELB 2007-080		8				45	4	4,450	8.44	8.84	9.28	9.78	10.95
CSELB 2008-020	R0.4	2	0.64	0.79	11°	45	4	4,220	2.15	2.24	2.34	2.45	2.72
CSELB 2008-020-6		2				50	6	6,380	2.15	2.24	2.34	2.45	2.72
CSELB 2008-030		3				45	4	4,450	3.20	3.34	3.50	3.67	4.09
CSELB 2008-030-6		3				50	6	6,730	3.20	3.34	3.50	3.67	4.09
CSELB 2008-040		4				45	4	4,450	4.25	4.44	4.65	4.89	5.45
CSELB 2008-040-6		4				50	6	6,730	4.25	4.44	4.65	4.89	5.45
CSELB 2008-050		5				45	4	4,450	5.29	5.54	5.81	6.11	6.82
CSELB 2008-060		6				45	4	4,450	6.34	6.64	6.97	7.33	8.19
CSELB 2008-060-6		6				50	6	6,730	6.34	6.64	6.97	7.33	8.19
CSELB 2008-070		7				45	4	4,450	7.39	7.74	8.12	8.55	9.56
CSELB 2008-080		8				45	4	4,450	8.44	8.84	9.28	9.77	10.93
CSELB 2008-080-6		8				50	6	6,730	8.44	8.84	9.28	9.77	10.93
CSELB 2008-090		9				45	4	5,930	9.48	9.93	10.43	10.99	12.30
CSELB 2008-100		10				50	4	5,930	10.53	11.03	11.59	12.21	13.67
CSELB 2008-100-6		10				50	6	8,550	10.53	11.03	11.59	12.21	13.67
CSELB 2008-120		12				45	4	7,300	12.62	13.23	13.90	14.64	16.41
CSELB 2008-160		16				50	4	9,990	16.81	17.62	18.52	19.52	21.88

- 3mm Shank V Series
- UDC-PCD Series
- CBN Series
- Square
- Long Neck Square
- Radius
- Long Neck Radius
- Taper Neck Radius
- Ball / Long Shank Ball
- Long Neck Ball
- Taper Neck Ball
- Taper
- Barrel
- Spiral V Cutter
- Drill
- Technical Data

Unit (mm)

Model Number	Radius of Ball Nose R	Effective Length l_1	Length of Cut l	Neck Diameter ϕd	Shank Taper Angle B α	Overall Length L	Shank Diameter ϕd	Suggested Retail Price ¥	Effective Length by Inclined Angles								
									30°	1°	1°30'	2°	3°				
CSELB 2009-020	RO.45	2	0.72	0.89	11°	45	4	4,220	2.15	2.24	2.34	2.44	2.70				
CSELB 2009-040		4				45	4	4,450	4.25	4.44	4.65	4.88	5.44				
CSELB 2009-060		6				45	4	4,450	6.34	6.63	6.96	7.32	8.17				
CSELB 2009-080		8				45	4	4,450	8.43	8.83	9.27	9.76	10.91				
CSELB 2009-100		10				45	4	5,930	10.53	11.03	11.58	12.19	13.65				
CSELB 2009-120		12				45	4	7,300	12.62	13.23	13.89	14.63	16.39				
CSELB 2009-140		14				50	4	8,460	14.72	15.42	16.20	17.07	19.13				
CSELB 2009-160		16				50	4	9,990	16.81	17.62	18.51	19.51	21.87				
CSELB 2009-180		18				55	4	9,990	18.90	19.82	20.83	21.95	24.60				
CSELB 2010-020	RO.5	2	0.8	0.98	11°	45	4	3,530	2.17	2.25	2.35	2.45	2.70				
CSELB 2010-025		2.5				45	4	3,530	2.69	2.80	2.92	3.06	3.39				
CSELB 2010-030		3				45	4	3,530	3.21	3.35	3.50	3.67	4.07				
CSELB 2010-030-6		3				50	6	5,590	3.21	3.35	3.50	3.67	4.07				
CSELB 2010-040		4				45	4	3,990	4.26	4.45	4.66	4.89	5.44				
CSELB 2010-040-6		4				50	6	6,160	4.26	4.45	4.66	4.89	5.44				
CSELB 2010-050		5				45	4	3,990	5.31	5.55	5.81	6.11	6.81				
CSELB 2010-050-6		5				50	6	6,160	5.31	5.55	5.81	6.11	6.81				
CSELB 2010-060		6				45	4	4,330	6.35	6.65	6.97	7.33	8.18				
CSELB 2010-060-6		6				50	6	6,500	6.35	6.65	6.97	7.33	8.18				
CSELB 2010-070		7				45	4	4,330	7.40	7.74	8.12	8.55	9.55				
CSELB 2010-070-6		7				50	6	6,500	7.40	7.74	8.12	8.55	9.55				
CSELB 2010-080		8				45	4	4,330	8.45	8.84	9.28	9.76	10.92				
CSELB 2010-080-6		8				50	6	6,500	8.45	8.84	9.28	9.76	10.92				
CSELB 2010-090		9				45	4	4,330	9.49	9.94	10.44	10.98	12.29				
CSELB 2010-100		10				45	4	4,330	10.54	11.04	11.59	12.20	13.65				
CSELB 2010-100-6		10				50	6	6,500	10.54	11.04	11.59	12.20	13.65				
CSELB 2010-120		12				45	4	4,330	12.64	13.24	13.90	14.64	16.39				
CSELB 2010-120-6		12				50	6	6,500	12.64	13.24	13.90	14.64	16.39				
CSELB 2010-140		14				50	4	5,020	14.73	15.43	16.21	17.08	19.13				
CSELB 2010-140-6		14				60	6	7,070	14.73	15.43	16.21	17.08	19.13				
CSELB 2010-160		16				50	4	5,930	16.82	17.63	18.53	19.52	21.87				
CSELB 2010-160-6		16				60	6	8,550	16.82	17.63	18.53	19.52	21.87				
CSELB 2010-180		18				55	4	5,930	18.92	19.83	20.84	21.95	24.61				
CSELB 2010-200		20				55	4	7,180	21.01	22.03	23.15	24.39	27.35				
CSELB 2010-200-6		20				70	6	10,150	21.01	22.03	23.15	24.39	27.35				
CSELB 2010-220-6		22				70	6	10,600	23.11	24.22	25.46	26.83	30.08				
CSELB 2012-025		RO.6				2.5	0.96	1.19	11°	45	4	5,360	2.58	2.68	2.80	2.92	3.22
CSELB 2012-040						4				45	4	5,360	4.15	4.33	4.53	4.75	5.27
CSELB 2012-060						6				45	4	5,810	6.25	6.53	6.84	7.19	8.01
CSELB 2012-060-6	6		50	6	8,270	6.25				6.53	6.84	7.19	8.01				
CSELB 2012-080	8		45	4	5,810	8.34				8.73	9.15	9.63	10.75				
CSELB 2012-080-6	8		50	6	8,270	8.34				8.73	9.15	9.63	10.75				
CSELB 2012-100	10		45	4	5,810	10.44				10.92	11.46	12.06	13.49				
CSELB 2012-100-6	10		50	6	8,270	10.44				10.92	11.46	12.06	13.49				
CSELB 2012-120	12		45	4	5,810	12.53				13.12	13.78	14.50	16.23				
CSELB 2012-120-6	12		50	6	8,270	12.53				13.12	13.78	14.50	16.23				
CSELB 2012-140	14		50	4	6,270	14.62				15.32	16.09	16.94	18.96				
CSELB 2012-160	16		50	4	6,840	16.72				17.52	18.40	19.38	21.70				
CSELB 2012-160-6	16		60	6	9,410	16.72				17.52	18.40	19.38	21.70				
CSELB 2012-180	18		55	4	7,410	18.81				19.71	20.71	21.82	24.44				
CSELB 2012-200	20		60	4	7,410	20.91				21.91	23.02	24.25	27.18				

3mm Shank V Series

UDC-PCD Series

CBN Series

Square

Long Neck Square

Radius

Long Neck Radius

Taper Neck Radius

Ball / Long Shank Ball

Long Neck Ball

Taper Neck Ball

Taper

Barrel

Spiral V Cutter

Drill

Technical Data

Model Number	Radius of Ball Nose R	Effective Length l_1	Length of Cut l	Neck Diameter ϕd_1	Shank Taper Angle Bia	Overall Length L	Shank Diameter ϕd	Suggested Retail Price ¥	Effective Length by Inclined Angles				
									30°	1°	1°30'	2°	3°
CSELB 2014-060	RO.7	6	1.12	1.37	11°	45	4	5,020	6.30	6.58	6.89	7.23	8.04
CSELB 2014-080		8				45	4	5,020	8.39	8.77	9.20	9.67	10.78
CSELB 2014-120		12				45	4	5,020	12.58	13.17	13.82	14.54	16.26
CSELB 2014-160		16				50	4	5,020	16.77	17.56	18.44	19.42	21.74
CSELB 2015-030	RO.75	3	1.2	1.47	11°	45	4	4,100	3.15	3.28	3.41	3.56	3.92
CSELB 2015-040		4				45	4	4,100	4.20	4.37	4.57	4.78	5.29
CSELB 2015-060		6				45	4	4,100	6.29	6.57	6.88	7.22	8.03
CSELB 2015-060-6		6				50	6	6,610	6.29	6.57	6.88	7.22	8.03
CSELB 2015-080		8				45	4	4,330	8.39	8.77	9.19	9.66	10.77
CSELB 2015-080-6		8				50	6	6,610	8.39	8.77	9.19	9.66	10.77
CSELB 2015-100		10				45	4	4,670	10.48	10.97	11.50	12.09	13.50
CSELB 2015-100-6		10				50	6	6,610	10.48	10.97	11.50	12.09	13.50
CSELB 2015-120		12				45	4	5,020	12.58	13.16	13.81	14.53	16.24
CSELB 2015-120-6		12				50	6	7,520	12.58	13.16	13.81	14.53	16.24
CSELB 2015-140		14				50	4	5,020	14.67	15.36	16.12	16.97	18.98
CSELB 2015-160		16				50	4	5,020	16.76	17.56	18.43	19.41	21.72
CSELB 2015-160-6		16				60	6	7,520	16.76	17.56	18.43	19.41	21.72
CSELB 2015-180		18				55	4	5,020	18.86	19.76	20.75	21.85	24.46
CSELB 2015-200		20				55	4	5,020	20.95	21.95	23.06	24.28	No Interference
CSELB 2015-200-6		20				60	6	7,520	20.95	21.95	23.06	24.28	27.19
CSELB 2015-220	22	55	4	5,020	23.05	24.15	25.37	26.72	No Interference				
CSELB 2015-250	25	65	4	7,000	26.19	27.45	28.84	30.38	No Interference				
CSELB 2015-300	30	70	4	8,210	31.42	32.94	34.61	36.47	No Interference				
CSELB 2016-040	RO.8	4	1.28	1.58	11°	45	4	5,700	4.17	4.34	4.53	4.74	5.24
CSELB 2016-080		8				45	4	5,810	8.36	8.74	9.15	9.61	10.71
CSELB 2016-120		12				45	4	5,810	12.55	13.13	13.77	14.49	16.19
CSELB 2016-160		16				50	4	5,810	16.74	17.53	18.40	19.37	21.66
CSELB 2016-200		20				55	4	5,810	20.92	21.92	23.02	24.24	No Interference
CSELB 2018-040	RO.9	4	1.44	1.78	11°	45	4	4,750	4.17	4.33	4.51	4.72	5.20
CSELB 2018-060		6				45	4	4,750	6.26	6.53	6.83	7.15	7.94
CSELB 2018-080		8				45	4	5,020	8.35	8.73	9.14	9.59	10.68
CSELB 2018-100		10				45	4	5,020	10.45	10.92	11.45	12.03	13.41
CSELB 2018-120		12				45	4	5,020	12.54	13.12	13.76	14.47	16.15
CSELB 2018-160		16				50	4	5,020	16.73	17.52	18.38	19.34	21.63
CSELB 2018-180		18				55	4	5,020	18.82	19.71	20.69	21.78	No Interference
CSELB 2018-200		20				55	4	5,020	20.92	21.91	23.00	24.22	No Interference
CSELB 2018-220		22				60	4	6,870	23.01	24.11	25.32	26.66	No Interference
CSELB 2018-250		25				65	4	7,000	26.15	27.40	28.78	30.32	No Interference
CSELB 2018-300		30				70	4	7,930	31.39	32.90	34.56	No Interference	No Interference

Unit (mm)

Model Number	Radius of Ball Nose R	Effective Length l_1	Length of Cut l	Neck Diameter ϕd	Shank Taper Angle Bta	Overall Length L	Shank Diameter ϕd	Suggested Retail Price ¥	Effective Length by Inclined Angles								
									30°	1°	1°30'	2°	3°				
CSELB 2020-030	R1	3	1.6	1.98	11°	45	4	3,530	3.11	3.22	3.34	3.48	3.79				
CSELB 2020-040		4				45	4	3,530	4.16	4.32	4.50	4.70	5.16				
CSELB 2020-040-6		4				50	6	5,590	4.16	4.32	4.50	4.70	5.16				
CSELB 2020-060		6				45	4	3,990	6.26	6.52	6.81	7.13	7.90				
CSELB 2020-060-6		6				50	6	6,040	6.26	6.52	6.81	7.13	7.90				
CSELB 2020-080		8				45	4	4,330	8.35	8.72	9.12	9.57	10.64				
CSELB 2020-080-6		8				50	6	6,500	8.35	8.72	9.12	9.57	10.64				
CSELB 2020-100		10				45	4	4,330	10.44	10.91	11.43	12.01	13.38				
CSELB 2020-100-6		10				50	6	6,500	10.44	10.91	11.43	12.01	13.38				
CSELB 2020-120		12				45	4	4,330	12.54	13.11	13.74	14.45	16.12				
CSELB 2020-120-6		12				50	6	6,500	12.54	13.11	13.74	14.45	16.12				
CSELB 2020-130		13				45	4	4,330	13.59	14.21	14.90	15.67	17.49				
CSELB 2020-140		14				50	4	4,330	14.63	15.31	16.06	16.89	18.85				
CSELB 2020-160		16				50	4	4,330	16.73	17.51	18.37	19.32	No Interference				
CSELB 2020-160-6		16				60	6	6,500	16.73	17.51	18.37	19.32	21.59				
CSELB 2020-180		18				55	4	4,330	18.82	19.70	20.68	21.76	No Interference				
CSELB 2020-200		20				55	4	4,330	20.91	21.90	22.99	24.20	No Interference				
CSELB 2020-200-6		20				70	6	6,500	20.91	21.90	22.99	24.20	27.07				
CSELB 2020-220		22				60	4	5,930	23.01	24.10	25.30	26.64	No Interference				
CSELB 2020-250		25				65	4	6,040	26.15	27.39	28.77	No Interference	No Interference				
CSELB 2020-250-6		25				80	6	8,550	26.15	27.39	28.77	30.29	33.92				
CSELB 2020-270		27				65	4	6,040	28.24	29.59	31.08	No Interference	No Interference				
CSELB 2020-300		30				70	4	6,840	31.38	32.89	34.55	No Interference	No Interference				
CSELB 2020-300-6		30				80	6	9,690	31.38	32.89	34.55	36.39	No Interference				
CSELB 2020-320		32				70	4	6,840	33.48	35.08	36.86	No Interference	No Interference				
CSELB 2020-350		35				80	4	9,350	36.62	38.38	No Interference	No Interference	No Interference				
CSELB 2020-350-6		35				80	6	12,650	36.62	38.38	40.32	42.48	No Interference				
CSELB 2020-400		40				80	4	9,350	41.85	43.87	No Interference	No Interference	No Interference				
CSELB 2020-400-6		40				90	6	12,650	41.85	43.87	46.10	48.58	No Interference				
CSELB 2025-060		R1.25				6	2	2.45	11°	45	4	4,670	6.33	6.58	6.86	7.17	7.92
CSELB 2025-080						8				45	4	4,700	8.42	8.78	9.17	9.61	10.66
CSELB 2025-100						10				45	4	4,900	10.51	10.97	11.48	12.05	13.39
CSELB 2025-150	15		50	4	5,810	15.75				16.47	17.26	18.14	No Interference				
CSELB 2025-200	20		55	4	6,840	20.98				21.96	23.04	No Interference	No Interference				
CSELB 2025-250	25		65	4	7,300	26.22				27.45	28.82	No Interference	No Interference				
CSELB 2025-300	30		70	4	7,300	31.45				32.95	No Interference	No Interference	No Interference				
CSELB 2025-350	35		70	4	8,440	36.69				38.44	No Interference	No Interference	No Interference				
CSELB 2030-060	R1.5	6	2.4	2.95	11°	60	6	4,330	6.31	6.55	6.82	7.12	7.83				
CSELB 2030-060-3		6			60	3	3,990	No Interference	No Interference	No Interference	No Interference	No Interference					
CSELB 2030-060-4		6			60	4	3,990	6.31	6.55	6.82	7.12	7.83					
CSELB 2030-080		8			60	6	4,330	8.41	8.75	9.13	9.56	10.57					
CSELB 2030-100		10			60	6	5,020	10.50	10.95	11.44	12.00	13.30					
CSELB 2030-120		12			60	6	5,240	12.60	13.15	13.76	14.43	16.04					
CSELB 2030-140		14			60	6	5,810	14.69	15.34	16.07	16.87	18.78					
CSELB 2030-150		15			60	6	5,700	15.74	16.44	17.22	18.09	20.15					
CSELB 2030-160		16			60	6	5,810	16.78	17.54	18.38	19.31	21.52					
CSELB 2030-180		18			60	6	5,810	18.88	19.74	20.69	21.75	24.26					
CSELB 2030-200		20			70	6	5,590	20.97	21.94	23.00	24.19	27.00					
CSELB 2030-220		22			70	6	5,590	23.07	24.13	25.31	26.62	29.73					
CSELB 2030-250		25			70	6	5,590	26.21	27.43	28.78	30.28	No Interference					
CSELB 2030-270		27			70	6	5,590	28.30	29.63	31.09	32.72	No Interference					
CSELB 2030-300		30			70	6	6,380	31.44	32.92	34.56	36.38	No Interference					
CSELB 2030-320		32			80	6	8,090	33.54	35.12	36.87	38.81	No Interference					
CSELB 2030-350		35			80	6	8,090	36.68	38.42	40.34	42.47	No Interference					
CSELB 2030-400		40			80	6	10,030	41.91	43.91	46.12	No Interference	No Interference					

Ø3mm Shank V Series

UDC-PCD Series

CBN Series

Square

Long Neck Square

Radius

Long Neck Radius

Taper Neck Radius

Ball / Long Shank Ball

Long Neck Ball

Taper Neck Ball

Taper

Barrel

Spiral V Cutter

Drill

Technical Data

Model Number	Radius of Ball Nose R	Effective Length l_1	Length of Cut l	Neck Diameter ϕd_1	Shank Taper Angle Bia	Overall Length L	Shank Diameter ϕd	Suggested Retail Price ¥	Effective Length by Inclined Angles							
									30°	1°	1°30'	2°	3°			
CSELB 2035-100	R1.75	10	2.8	3.45	11°	60	6	6,380	10.49	10.93	11.41	11.94	13.21			
CSELB 2035-150		15				60	6	6,380	15.72	16.42	17.19	18.04	20.06			
CSELB 2035-200		20				65	6	6,840	20.96	21.91	22.96	24.13	No Interference			
CSELB 2035-250		25				70	6	6,840	26.19	27.40	28.74	30.23	No Interference			
CSELB 2035-300		30				70	6	7,300	31.43	32.90	34.52	36.32	No Interference			
CSELB 2035-400		40				90	6	9,690	41.90	43.88	46.08	No Interference	No Interference			
CSELB 2035-450		45				90	6	10,600	47.13	49.38	No Interference	No Interference	No Interference			
CSELB 2040-080		R2				8	3.2	3.95	11°	70	6	4,450	8.38	8.70	9.06	9.45
CSELB 2040-080-4	—		70	4	4,180	No Interference			No Interference	No Interference	No Interference	No Interference				
CSELB 2040-100	10		70	6	4,450	10.48			10.90	11.37	11.89	13.12				
CSELB 2040-120	12		70	6	5,810	12.57			13.10	13.68	14.33	15.86				
CSELB 2040-140	14		70	6	5,810	14.67			15.30	15.99	16.76	18.60				
CSELB 2040-150	15		70	6	5,810	15.71			16.39	17.15	17.98	19.97				
CSELB 2040-160	16		70	6	5,810	16.76			17.49	18.30	19.20	No Interference				
CSELB 2040-180	18		70	6	5,810	18.85			19.69	20.61	21.64	No Interference				
CSELB 2040-200	20		70	6	5,810	20.95			21.89	22.93	24.08	No Interference				
CSELB 2040-220	22		70	6	5,810	23.04			24.08	25.24	26.52	No Interference				
CSELB 2040-250	25		70	6	5,810	26.18			27.38	28.70	30.17	No Interference				
CSELB 2040-270	27		70	6	5,810	28.28			29.58	31.01	No Interference	No Interference				
CSELB 2040-300	30		70	6	5,810	31.42			32.87	34.48	No Interference	No Interference				
CSELB 2040-320	32		80	6	6,730	33.51			35.07	36.79	No Interference	No Interference				
CSELB 2040-350	35		80	6	6,730	36.65			38.37	40.26	No Interference	No Interference				
CSELB 2040-400	40		90	6	7,520	41.89			43.86	No Interference	No Interference	No Interference				
CSELB 2040-450	45		90	6	9,690	47.12			49.35	No Interference	No Interference	No Interference				
CSELB 2040-500	50		100	6	10,370	52.36			54.85	No Interference	No Interference	No Interference				
CSELB 2040-600	60		120	6	10,580	62.83			No Interference	No Interference	No Interference	No Interference				
CSELB 2050-100	R2.5		10	4	4.95	11°			70	6	6,840	10.45	10.85	11.29	11.78	No Interference
CSELB 2050-150			15						70	6	9,690	15.69	16.35	17.07	No Interference	No Interference
CSELB 2050-200			20						70	6	9,690	20.92	21.84	No Interference	No Interference	No Interference
CSELB 2050-250			25						70	6	9,690	26.16	27.33	No Interference	No Interference	No Interference
CSELB 2050-300			30						80	6	10,370	31.39	No Interference	No Interference	No Interference	No Interference
CSELB 2050-350		35	80				6	10,370	36.63	No Interference	No Interference	No Interference	No Interference			
CSELB 2050-400		40	90				6	13,110	41.86	No Interference	No Interference	No Interference	No Interference			
CSELB 2050-450		45	100				6	13,680	47.10	No Interference	No Interference	No Interference	No Interference			
CSELB 2050-500		50	100				6	14,820	52.33	No Interference	No Interference	No Interference	No Interference			
CSELB 2060-100		R3	10				4.8	5.95	—	80	6	7,300	No Interference	No Interference	No Interference	No Interference
CSELB 2060-150	15		80	6	7,300	No Interference				No Interference	No Interference	No Interference	No Interference			
CSELB 2060-180	18		80	6	7,300	No Interference				No Interference	No Interference	No Interference	No Interference			
CSELB 2060-200	20		80	6	7,300	No Interference				No Interference	No Interference	No Interference	No Interference			
CSELB 2060-220	22		80	6	7,300	No Interference				No Interference	No Interference	No Interference	No Interference			
CSELB 2060-250	25		80	6	7,300	No Interference				No Interference	No Interference	No Interference	No Interference			
CSELB 2060-270	27		80	6	7,300	No Interference				No Interference	No Interference	No Interference	No Interference			
CSELB 2060-300	30		80	6	7,520	No Interference				No Interference	No Interference	No Interference	No Interference			
CSELB 2060-320	32		80	6	7,520	No Interference				No Interference	No Interference	No Interference	No Interference			
CSELB 2060-350	35		80	6	7,750	No Interference				No Interference	No Interference	No Interference	No Interference			
CSELB 2060-400	40		90	6	8,210	No Interference				No Interference	No Interference	No Interference	No Interference			
CSELB 2060-450	45		100	6	8,780	No Interference				No Interference	No Interference	No Interference	No Interference			
CSELB 2060-500	50		120	6	8,890	No Interference				No Interference	No Interference	No Interference	No Interference			
CSELB 2060-600	60		120	6	9,420	No Interference				No Interference	No Interference	No Interference	No Interference			

φ3mm Shank V Series

UDC-PCD Series

CBN Series

Square Long Neck Square

Radius

Long Neck Radius

Taper Neck Radius

Ball / Long Shank Ball

Long Neck Ball

Taper Neck Ball

Taper

Barrel

Spiral V Cutter

Drill

Technical Data

Milling Conditions for CSELB

WORK MATERIAL		COPPER / ALUMINUM ALLOYS					CARBON STEELS / ALLOY STEELS S45C / S50C / SK / SCM (~325HB)				PREHARDENED STEELS NAK80 / STAVAX / HPM38 (30~45HRC)				HARDENED STEELS STAVAX / HPM38 / SKD61 (45~55HRC)				
Model Number	Radius of Ball Nose (mm)	Effective Length (mm)	Spindle Speed (min ⁻¹)	Feed Rate (mm/min)	a _p Axial Depth (mm)	a _e Radial Depth (mm)	Spindle Speed (min ⁻¹)	Feed Rate (mm/min)	a _p Axial Depth (mm)	a _e Radial Depth (mm)	Spindle Speed (min ⁻¹)	Feed Rate (mm/min)	a _p Axial Depth (mm)	a _e Radial Depth (mm)	Spindle Speed (min ⁻¹)	Feed Rate (mm/min)	a _p Axial Depth (mm)	a _e Radial Depth (mm)	
2001-002	R0.05	0.2	54,000	85	0.004	0.004	54,000	85	0.004	0.004	48,000	55	0.002	0.002	48,000	55	0.002	0.002	
2001-003		0.3	54,000	85	0.004	0.004	54,000	85	0.004	0.004	48,000	55	0.002	0.002	48,000	55	0.002	0.002	
2001-005		0.5	54,000	75	0.004	0.004	54,000	75	0.004	0.004	48,000	35	0.002	0.002	48,000	35	0.002	0.002	
20015-003	R0.075	0.3	54,000	160	0.007	0.009	54,000	160	0.007	0.009	48,000	90	0.004	0.004	48,000	90	0.004	0.004	
20015-005		0.5	54,000	140	0.007	0.009	54,000	140	0.007	0.009	48,000	60	0.004	0.004	48,000	60	0.004	0.004	
20015-010		1	54,000	100	0.003	0.005	54,000	100	0.003	0.005	48,000	60	0.001	0.002	48,000	60	0.001	0.002	
2002-003	R0.1	0.3	60,000	350	0.008	0.024	60,000	350	0.008	0.016	60,000	300	0.008	0.024	60,000	300	0.006	0.018	
2002-005		0.5	60,000	350	0.008	0.024	60,000	350	0.008	0.016	60,000	300	0.008	0.024	60,000	300	0.006	0.018	
2002-0075		0.75	60,000	300	0.007	0.021	60,000	320	0.007	0.015	60,000	300	0.007	0.021	60,000	270	0.005	0.015	
2002-010		1	60,000	250	0.006	0.018	60,000	250	0.005	0.015	60,000	250	0.006	0.018	60,000	220	0.005	0.015	
2002-0125		1.25	54,000	225	0.005	0.016	54,000	215	0.004	0.013	60,000	225	0.005	0.016	54,000	195	0.004	0.013	
2002-015		1.5	48,000	200	0.005	0.015	48,000	180	0.004	0.012	60,000	200	0.005	0.015	48,000	170	0.004	0.012	
2002-0175		1.75	48,000	175	0.004	0.012	48,000	165	0.003	0.01	60,000	175	0.004	0.012	48,000	145	0.003	0.009	
2002-020		2	48,000	150	0.003	0.009	48,000	150	0.003	0.009	60,000	150	0.003	0.009	48,000	120	0.003	0.007	
2002-0225		2.25	44,000	125	0.003	0.007	44,000	125	0.003	0.007	53,000	125	0.002	0.007	44,000	110	0.002	0.005	
2002-025		2.5	40,000	100	0.003	0.006	40,000	100	0.003	0.006	46,000	100	0.002	0.006	40,000	100	0.002	0.004	
2002-030		3	33,000	50	0.002	0.003	33,000	50	0.002	0.003	33,000	50	0.002	0.003	33,000	50	0.002	0.002	
2003-005		R0.15	0.5	43,000	500	0.012	0.036	43,000	500	0.012	0.024	54,000	450	0.012	0.036	43,000	450	0.008	0.024
2003-006			0.6	43,000	500	0.012	0.036	43,000	500	0.012	0.024	54,000	450	0.012	0.036	43,000	450	0.008	0.024
2003-0075			0.75	43,000	500	0.012	0.036	43,000	500	0.012	0.024	54,000	450	0.012	0.036	43,000	450	0.008	0.024
2003-010			1	43,000	450	0.01	0.03	43,000	450	0.008	0.024	54,000	400	0.01	0.03	43,000	400	0.007	0.021
2003-0125	1.25		43,000	425	0.009	0.027	43,000	425	0.007	0.022	54,000	400	0.009	0.027	43,000	400	0.006	0.019	
2003-015	1.5		43,000	400	0.008	0.024	43,000	400	0.007	0.021	54,000	400	0.008	0.024	43,000	400	0.006	0.018	
2003-0175	1.75		41,500	350	0.007	0.021	41,500	350	0.006	0.019	52,000	350	0.007	0.022	41,500	350	0.005	0.016	
2003-020	2		40,000	300	0.006	0.018	40,000	300	0.006	0.018	50,000	300	0.007	0.021	40,000	300	0.005	0.015	
2003-0225	2.25		40,000	275	0.005	0.016	40,000	275	0.005	0.016	48,000	275	0.006	0.018	40,000	275	0.004	0.013	
2003-025	2.5		40,000	250	0.005	0.015	40,000	250	0.005	0.015	46,000	250	0.005	0.015	40,000	250	0.004	0.012	
2003-030	3		38,000	200	0.004	0.012	38,000	200	0.004	0.012	42,000	200	0.004	0.012	38,000	200	0.004	0.008	
2003-040	4		35,000	100	0.003	0.009	35,000	100	0.003	0.009	35,000	100	0.003	0.009	32,000	100	0.003	0.005	
2003-050	5		26,000	60	0.003	0.004	26,000	60	0.003	0.004	26,000	60	0.003	0.004	26,000	60	0.003	0.003	
2004-005	R0.2		0.5	35,000	1,200	0.03	0.09	35,000	1,200	0.02	0.04	50,000	650	0.025	0.075	35,000	650	0.015	0.045
2004-0075			0.75	35,000	1,200	0.03	0.09	35,000	1,200	0.02	0.04	50,000	650	0.025	0.075	35,000	650	0.015	0.045
2004-010		1	35,000	1,200	0.03	0.09	35,000	1,200	0.02	0.04	50,000	650	0.025	0.075	35,000	650	0.015	0.045	
2004-0125		1.25	35,000	1,050	0.025	0.075	35,000	1,050	0.018	0.036	50,000	600	0.022	0.067	35,000	575	0.013	0.04	
2004-015		1.5	35,000	900	0.02	0.06	35,000	900	0.016	0.033	50,000	550	0.02	0.06	35,000	500	0.012	0.036	
2004-0175		1.75	35,000	750	0.017	0.052	35,000	750	0.013	0.033	50,000	525	0.017	0.052	35,000	450	0.011	0.033	
2004-020		2	35,000	600	0.015	0.045	35,000	600	0.011	0.033	50,000	500	0.015	0.045	35,000	400	0.01	0.03	
2004-0225		2.25	35,000	525	0.013	0.04	35,000	525	0.01	0.031	48,000	475	0.013	0.04	35,000	380	0.01	0.027	
2004-025		2.5	35,000	450	0.012	0.036	35,000	450	0.01	0.03	46,000	450	0.012	0.036	35,000	360	0.01	0.025	
2004-030		3	35,000	400	0.01	0.03	35,000	400	0.008	0.024	42,000	400	0.01	0.03	35,000	330	0.007	0.021	
2004-035		3.5	35,000	350	0.007	0.02	35,000	350	0.006	0.018	38,000	350	0.007	0.021	35,000	300	0.007	0.018	
2004-040		4	35,000	300	0.005	0.015	35,000	300	0.005	0.015	35,000	300	0.005	0.015	35,000	250	0.005	0.015	
2004-045		4.5	32,000	230	0.004	0.012	32,000	230	0.004	0.012	32,000	230	0.004	0.012	32,000	200	0.004	0.01	
2004-050		5	30,000	160	0.003	0.01	30,000	160	0.003	0.01	30,000	160	0.003	0.01	30,000	150	0.003	0.008	
2004-060		6	23,000	90	0.003	0.005	23,000	90	0.003	0.005	23,000	90	0.003	0.005	23,000	80	0.003	0.004	

Ø3mm Shank
V SeriesUDC-PCD
SeriesCBN
SeriesSquare
Long Neck
SquareRadius
Long Neck
Radius
Taper Neck
RadiusBall / Long
Shank Ball
Long Neck
Ball
Taper Neck
Ball

Taper

Barrel

Spiral
V Cutter

Drill

Technical Data

Milling Conditions for CSELB

WORK MATERIAL			COPPER / ALUMINUM ALLOYS				CARBON STEELS / ALLOY STEELS S45C / S50C / SK / SCM (~32SHB)				PREHARDENED STEELS NAK80 / STAVAX / HPM38 (30~45HRC)				HARDENED STEELS STAVAX / HPM38 / SKD61 (45~55HRC)			
Model Number	Radius of Ball Nose (mm)	Effective Length (mm)	Spindle Speed (min ⁻¹)	Feed Rate (mm/min)	a _p Axial Depth (mm)	a _e Radial Depth (mm)	Spindle Speed (min ⁻¹)	Feed Rate (mm/min)	a _p Axial Depth (mm)	a _e Radial Depth (mm)	Spindle Speed (min ⁻¹)	Feed Rate (mm/min)	a _p Axial Depth (mm)	a _e Radial Depth (mm)	Spindle Speed (min ⁻¹)	Feed Rate (mm/min)	a _p Axial Depth (mm)	a _e Radial Depth (mm)
2005-010	R0.25	1	34,000	1,300	0.035	0.105	34,000	1,300	0.03	0.06	45,000	900	0.03	0.09	32,000	900	0.02	0.06
2005-0125		1.25	34,000	1,150	0.032	0.097	34,000	1,150	0.027	0.055	45,000	850	0.027	0.082	32,000	850	0.019	0.057
2005-015		1.5	34,000	1,000	0.03	0.09	34,000	1,000	0.025	0.05	45,000	800	0.025	0.075	32,000	800	0.018	0.054
2005-0175		1.75	34,000	900	0.027	0.082	34,000	900	0.024	0.048	45,000	750	0.023	0.07	32,000	750	0.017	0.051
2005-020		2	34,000	800	0.025	0.075	34,000	800	0.023	0.046	45,000	700	0.022	0.066	32,000	700	0.016	0.048
2005-0225		2.25	34,000	750	0.022	0.067	34,000	750	0.019	0.045	45,000	650	0.02	0.06	32,000	650	0.015	0.046
2005-025		2.5	34,000	700	0.02	0.06	34,000	700	0.015	0.045	45,000	600	0.018	0.054	32,000	600	0.015	0.045
2005-030		3	32,000	550	0.016	0.048	32,000	550	0.012	0.036	41,000	550	0.014	0.042	31,000	500	0.012	0.036
2005-035		3.5	32,000	500	0.014	0.042	32,000	500	0.011	0.033	38,000	500	0.012	0.036	30,500	450	0.01	0.03
2005-040		4	31,000	450	0.012	0.036	31,000	450	0.01	0.03	35,000	450	0.01	0.03	30,000	390	0.01	0.03
2005-045		4.5	30,000	390	0.01	0.03	30,000	390	0.008	0.024	32,000	390	0.008	0.024	29,500	350	0.008	0.024
2005-050		5	29,000	340	0.007	0.021	29,000	340	0.007	0.021	29,000	340	0.006	0.018	29,000	300	0.006	0.018
2005-055	5.5	26,000	280	0.007	0.021	26,000	280	0.007	0.021	26,000	280	0.006	0.018	26,000	250	0.006	0.018	
2005-060	6	24,000	220	0.006	0.018	24,000	220	0.006	0.018	24,000	220	0.005	0.015	24,000	200	0.005	0.015	
2005-070	7	21,000	180	0.005	0.015	21,000	180	0.005	0.015	21,000	180	0.004	0.012	21,000	160	0.004	0.012	
2005-080	8	19,000	130	0.004	0.012	19,000	130	0.004	0.012	19,000	130	0.003	0.009	19,000	110	0.003	0.009	
2005-090	9	18,000	120	0.003	0.009	18,000	120	0.003	0.009	18,000	120	0.002	0.008	18,000	100	0.002	0.008	
2005-100	10	17,000	100	0.003	0.009	17,000	100	0.003	0.009	17,000	100	0.002	0.006	17,000	80	0.002	0.006	
2006-010	R0.3	1	33,000	1,500	0.05	0.15	33,000	1,500	0.04	0.08	40,000	1,300	0.045	0.09	30,000	1,300	0.04	0.06
2006-0125		1.25	33,000	1,500	0.05	0.15	33,000	1,500	0.04	0.08	40,000	1,300	0.045	0.09	30,000	1,300	0.04	0.06
2006-015		1.5	33,000	1,500	0.05	0.15	33,000	1,500	0.04	0.08	40,000	1,300	0.045	0.09	30,000	1,300	0.04	0.06
2006-0175		1.75	33,000	1,450	0.047	0.142	33,000	1,450	0.038	0.076	40,000	1,250	0.045	0.09	30,000	1,250	0.038	0.057
2006-020		2	33,000	1,400	0.045	0.135	33,000	1,400	0.036	0.072	40,000	1,200	0.045	0.09	30,000	1,200	0.036	0.054
2006-0225		2.25	33,000	1,250	0.042	0.127	33,000	1,300	0.034	0.069	40,000	1,100	0.042	0.085	30,000	1,150	0.034	0.053
2006-025		2.5	33,000	1,100	0.04	0.12	33,000	1,200	0.033	0.066	40,000	1,000	0.04	0.08	30,000	1,100	0.033	0.053
2006-030		3	33,000	900	0.035	0.105	33,000	900	0.025	0.066	40,000	800	0.03	0.075	30,000	900	0.026	0.052
2006-035		3.5	32,000	900	0.03	0.09	32,000	800	0.022	0.066	38,000	650	0.025	0.075	28,000	720	0.02	0.06
2006-040		4	31,000	700	0.027	0.081	31,000	700	0.02	0.06	35,000	560	0.022	0.066	28,000	600	0.018	0.054
2006-045		4.5	29,000	500	0.024	0.072	29,000	550	0.017	0.051	32,000	500	0.018	0.054	26,000	500	0.015	0.045
2006-050		5	29,000	440	0.018	0.054	29,000	440	0.015	0.045	29,000	440	0.015	0.045	26,000	440	0.012	0.036
2006-055	5.5	26,000	410	0.016	0.048	26,000	410	0.014	0.042	26,000	410	0.014	0.042	25,000	410	0.01	0.03	
2006-060	6	24,000	380	0.012	0.036	24,000	380	0.012	0.036	24,000	380	0.01	0.03	24,000	380	0.008	0.024	
2006-065	6.5	22,000	340	0.011	0.033	22,000	340	0.011	0.033	22,000	340	0.009	0.027	22,000	340	0.007	0.021	
2006-070	7	21,000	310	0.01	0.03	21,000	310	0.01	0.03	21,000	310	0.008	0.024	21,000	310	0.006	0.018	
2006-080	8	18,000	240	0.008	0.024	18,000	240	0.008	0.024	18,000	240	0.006	0.018	18,000	240	0.005	0.015	
2006-090	9	16,000	180	0.007	0.021	16,000	180	0.007	0.021	16,000	180	0.005	0.015	16,000	180	0.004	0.012	
2006-100	10	15,000	160	0.006	0.018	15,000	160	0.006	0.018	15,000	160	0.004	0.012	15,000	160	0.003	0.01	
2006-120	12	14,000	150	0.005	0.015	14,000	150	0.005	0.015	14,000	150	0.003	0.009	14,000	150	0.002	0.008	
2007-020	R0.35	2	32,000	1,800	0.07	0.21	32,000	1,600	0.05	0.1	38,000	1,600	0.06	0.12	28,000	1,600	0.05	0.075
2007-040		4	32,000	1,000	0.05	0.15	32,000	900	0.03	0.09	34,000	800	0.04	0.12	28,000	800	0.03	0.06
2007-060		6	26,000	550	0.022	0.066	26,000	550	0.018	0.054	26,000	500	0.018	0.054	23,000	500	0.014	0.042
2007-080		8	19,000	340	0.012	0.036	19,000	340	0.012	0.036	19,000	320	0.01	0.03	19,000	320	0.008	0.024

φ3mm Shank V Series

UDC-PCD Series

CBN Series

Square
Long Neck Square

Radius

Radius
Long Neck Radius
Taper Neck Radius

Ball / Long Shank Ball
Long Neck Ball

Taper Neck Ball

Taper

Barrel

Spiral V Cutter

Drill

Technical Data

Milling Conditions for CSELB

WORK MATERIAL			COPPER / ALUMINUM ALLOYS				CARBON STEELS / ALLOY STEELS S45C / S50C / SK / SCM (~325HB)				PREHARDENED STEELS NAK80 / STAVAX / HPM38 (30~45HRC)				HARDENED STEELS STAVAX / HPM38 / SKD61 (45~55HRC)				
Model Number	Radius of Ball Nose (mm)	Effective Length (mm)	Spindle Speed (min ⁻¹)	Feed Rate (mm/min)	a _p Axial Depth (mm)	a _e Radial Depth (mm)	Spindle Speed (min ⁻¹)	Feed Rate (mm/min)	a _p Axial Depth (mm)	a _e Radial Depth (mm)	Spindle Speed (min ⁻¹)	Feed Rate (mm/min)	a _p Axial Depth (mm)	a _e Radial Depth (mm)	Spindle Speed (min ⁻¹)	Feed Rate (mm/min)	a _p Axial Depth (mm)	a _e Radial Depth (mm)	
2008-020	R0.4	2	30,000	2,200	0.1	0.3	30,000	1,800	0.06	0.12	35,000	1,800	0.07	0.14	25,000	1,700	0.07	0.1	
2008-030		3	30,000	1,700	0.08	0.24	30,000	1,600	0.05	0.1	35,000	1,600	0.06	0.12	25,000	1,500	0.06	0.09	
2008-040		4	30,000	1,400	0.07	0.21	30,000	1,300	0.04	0.1	35,000	1,300	0.05	0.12	25,000	1,200	0.045	0.09	
2008-050		5	30,000	1,100	0.06	0.18	30,000	1,100	0.035	0.1	30,000	1,100	0.04	0.12	25,000	1,000	0.04	0.08	
2008-060		6	27,000	900	0.04	0.12	27,000	900	0.025	0.075	27,000	800	0.03	0.09	23,000	800	0.023	0.069	
2008-070		7	24,000	700	0.025	0.075	24,000	700	0.022	0.066	24,000	600	0.02	0.06	21,000	600	0.015	0.045	
2008-080		8	19,000	450	0.02	0.06	19,000	450	0.02	0.06	19,000	450	0.015	0.045	19,000	450	0.01	0.03	
2008-090		9	18,000	400	0.016	0.048	18,000	400	0.016	0.048	18,000	360	0.013	0.039	18,000	360	0.009	0.027	
2008-100		10	15,000	350	0.012	0.036	15,000	350	0.012	0.036	15,000	300	0.01	0.03	15,000	300	0.007	0.021	
2008-120		12	14,000	300	0.01	0.03	14,000	300	0.01	0.03	14,000	240	0.006	0.018	14,000	240	0.006	0.018	
2008-160		16	13,500	240	0.006	0.018	13,500	240	0.006	0.018	13,500	190	0.003	0.01	13,500	190	0.003	0.01	
2009-020		R0.45	2	30,000	2,100	0.11	0.33	30,000	1,600	0.07	0.14	33,000	1,700	0.08	0.16	24,000	1,600	0.08	0.12
2009-040	4		30,000	1,600	0.08	0.24	30,000	1,500	0.055	0.12	33,000	1,400	0.06	0.14	24,000	1,300	0.05	0.1	
2009-060	6		27,000	1,100	0.06	0.18	27,000	1,100	0.035	0.1	27,000	850	0.04	0.12	22,000	800	0.034	0.1	
2009-080	8		22,000	710	0.03	0.09	22,000	700	0.023	0.069	22,000	560	0.021	0.063	18,500	550	0.017	0.051	
2009-100	10		18,000	500	0.02	0.06	18,000	500	0.018	0.054	18,000	430	0.015	0.045	18,000	430	0.01	0.03	
2009-120	12		16,000	420	0.015	0.045	16,000	420	0.015	0.045	16,000	350	0.009	0.027	16,000	350	0.007	0.021	
2009-140	14		14,000	380	0.012	0.042	14,000	380	0.012	0.042	14,000	280	0.006	0.018	14,000	280	0.006	0.018	
2009-160	16		13,500	360	0.01	0.04	13,500	360	0.01	0.04	13,500	200	0.004	0.016	13,500	200	0.004	0.016	
2009-180	18		13,000	340	0.006	0.024	13,000	340	0.006	0.024	13,000	120	0.003	0.012	13,000	120	0.003	0.012	
2010-020	R0.5		2	30,000	2,000	0.12	0.36	30,000	1,600	0.08	0.16	30,000	1,600	0.09	0.18	22,000	1,600	0.09	0.13
2010-025			2.5	30,000	2,000	0.12	0.36	30,000	1,600	0.08	0.16	30,000	1,600	0.09	0.18	22,000	1,600	0.09	0.13
2010-030			3	30,000	1,800	0.11	0.33	24,000	1,600	0.07	0.14	30,000	1,500	0.08	0.16	21,500	1,400	0.08	0.12
2010-040		4	30,000	1,700	0.09	0.27	24,000	1,500	0.065	0.13	30,000	1,300	0.075	0.15	21,500	1,300	0.075	0.1	
2010-050		5	30,000	1,600	0.08	0.24	24,000	1,400	0.06	0.12	30,000	1,200	0.07	0.14	21,500	1,200	0.06	0.09	
2010-060		6	30,000	1,400	0.06	0.18	18,000	1,200	0.04	0.12	30,000	1,100	0.06	0.12	21,500	1,100	0.05	0.1	
2010-070		7	27,000	1,200	0.05	0.15	17,000	1,000	0.03	0.09	24,000	800	0.04	0.12	20,000	900	0.03	0.09	
2010-080		8	24,000	1,000	0.04	0.12	16,500	900	0.027	0.081	18,500	620	0.035	0.1	18,500	580	0.025	0.1	
2010-090		9	22,000	720	0.035	0.11	15,500	700	0.02	0.08	16,500	550	0.025	0.1	16,500	500	0.02	0.08	
2010-100		10	20,000	650	0.03	0.09	15,000	500	0.018	0.072	14,800	490	0.02	0.08	14,800	430	0.015	0.06	
2010-120		12	18,000	600	0.02	0.08	15,000	500	0.016	0.064	13,400	380	0.01	0.05	13,400	380	0.008	0.04	
2010-140		14	16,000	530	0.015	0.06	14,000	460	0.015	0.06	12,000	350	0.008	0.04	12,000	350	0.006	0.03	
2010-160	16	14,000	460	0.014	0.056	14,000	460	0.014	0.056	10,500	250	0.005	0.025	10,500	250	0.005	0.025		
2010-180	18	13,500	440	0.012	0.06	13,500	440	0.012	0.06	9,500	200	0.004	0.02	9,500	200	0.004	0.02		
2010-200	20	13,000	430	0.008	0.04	13,000	430	0.008	0.04	9,000	150	0.003	0.015	9,000	150	0.003	0.015		
2010-220	22	12,000	380	0.007	0.035	12,000	380	0.007	0.035	8,500	120	0.002	0.01	8,500	120	0.002	0.01		
2012-025	R0.6	2.5	30,000	2,000	0.13	0.39	30,000	1,600	0.09	0.18	30,000	1,600	0.1	0.2	18,000	1,600	0.1	0.15	
2012-040		4	30,000	1,800	0.12	0.36	20,000	1,500	0.08	0.16	30,000	1,400	0.09	0.18	18,000	1,400	0.09	0.13	
2012-060		6	30,000	1,600	0.09	0.27	20,000	1,200	0.07	0.14	30,000	1,100	0.08	0.16	18,000	1,100	0.08	0.12	
2012-080		8	25,000	1,200	0.06	0.18	15,000	900	0.05	0.12	20,000	800	0.06	0.15	16,500	750	0.05	0.11	
2012-100		10	20,000	900	0.05	0.15	13,500	650	0.035	0.11	16,000	640	0.045	0.12	15,500	550	0.03	0.09	
2012-120		12	16,500	600	0.035	0.12	12,500	480	0.025	0.1	12,000	440	0.03	0.12	12,500	430	0.018	0.072	
2012-140		14	14,500	520	0.025	0.1	12,500	480	0.022	0.088	11,000	400	0.015	0.06	11,500	370	0.014	0.056	
2012-160		16	13,000	470	0.018	0.072	11,500	440	0.018	0.072	10,000	350	0.01	0.05	10,000	350	0.01	0.05	
2012-180		18	12,000	460	0.014	0.07	11,250	440	0.014	0.07	9,500	260	0.008	0.04	9,500	260	0.007	0.035	
2012-200		20	11,000	440	0.013	0.065	11,000	440	0.013	0.065	9,000	220	0.006	0.03	9,000	220	0.005	0.025	

- Ø3mm Shank V Series
- UDC-PCD Series
- CBN Series
- Square
- Long Neck Square
- Radius
- Long Neck Radius
- Taper Neck Radius
- Ball / Long Shank Ball
- Long Neck Ball
- Taper Neck Ball
- Taper
- Barrel
- Spiral V Cutter
- Drill
- Technical Data

Milling Conditions for CSELB

WORK MATERIAL			COPPER / ALUMINUM ALLOYS				CARBON STEELS / ALLOY STEELS S45C / S50C / SK / SCM (~325HB)				PREHARDENED STEELS NAK80 / STAVAX / HPM38 (30~45HRC)				HARDENED STEELS STAVAX / HPM38 / SKD61 (45~55HRC)				
Model Number	Radius of Ball Nose (mm)	Effective Length (mm)	Spindle Speed (min ⁻¹)	Feed Rate (mm/min)	a _p Axial Depth (mm)	a _e Radial Depth (mm)	Spindle Speed (min ⁻¹)	Feed Rate (mm/min)	a _p Axial Depth (mm)	a _e Radial Depth (mm)	Spindle Speed (min ⁻¹)	Feed Rate (mm/min)	a _p Axial Depth (mm)	a _e Radial Depth (mm)	Spindle Speed (min ⁻¹)	Feed Rate (mm/min)	a _p Axial Depth (mm)	a _e Radial Depth (mm)	
2014-060	R0.7	6	30,000	1,700	0.11	0.33	23,000	1,500	0.08	0.16	30,000	1,300	0.09	0.18	16,000	1,200	0.09	0.13	
2014-080		8	30,000	1,400	0.09	0.27	17,000	1,000	0.06	0.15	30,000	1,000	0.07	0.17	15,000	900	0.06	0.12	
2014-120		12	17,000	900	0.06	0.18	13,000	600	0.04	0.12	13,000	580	0.045	0.14	12,500	550	0.03	0.1	
2014-160		16	12,500	540	0.028	0.12	11,000	500	0.024	0.1	9,500	380	0.016	0.08	9,500	380	0.015	0.06	
2015-030	R0.75	3	30,000	2,000	0.15	0.45	30,000	1,600	0.12	0.24	30,000	1,700	0.12	0.24	18,000	1,500	0.12	0.18	
2015-040		4	30,000	1,800	0.14	0.42	30,000	1,500	0.11	0.22	30,000	1,600	0.11	0.22	18,000	1,400	0.11	0.17	
2015-060		6	30,000	1,800	0.12	0.36	23,000	1,300	0.1	0.2	30,000	1,400	0.1	0.2	15,000	1,200	0.1	0.16	
2015-080		8	30,000	1,600	0.11	0.33	18,000	1,100	0.08	0.16	30,000	1,200	0.08	0.2	14,000	1,000	0.08	0.16	
2015-100		10	23,000	1,200	0.09	0.27	15,000	850	0.06	0.15	23,500	900	0.06	0.18	14,000	700	0.05	0.15	
2015-120		12	16,000	900	0.07	0.21	13,000	600	0.05	0.15	13,000	650	0.05	0.15	13,000	550	0.03	0.12	
2015-140		14	14,500	700	0.05	0.19	10,500	550	0.04	0.12	10,500	500	0.04	0.12	10,500	470	0.025	0.1	
2015-160		16	13,000	650	0.04	0.16	10,000	550	0.03	0.12	8,850	400	0.03	0.12	8,850	390	0.02	0.08	
2015-180		18	12,000	580	0.03	0.15	10,000	510	0.025	0.1	8,500	350	0.018	0.09	8,500	360	0.014	0.07	
2015-200		20	10,500	530	0.02	0.1	9,200	470	0.02	0.1	8,000	320	0.012	0.06	8,000	320	0.012	0.06	
2015-220		22	10,000	500	0.015	0.075	9,000	460	0.015	0.075	7,500	270	0.01	0.05	7,500	270	0.008	0.04	
2015-250		25	9,000	440	0.014	0.07	8,750	440	0.014	0.07	7,250	250	0.008	0.04	7,250	250	0.006	0.03	
2015-300		30	8,500	420	0.012	0.06	8,500	420	0.012	0.06	7,000	130	0.006	0.03	7,000	130	0.004	0.02	
2016-040		R0.8	4	30,000	2,000	0.16	0.48	30,000	1,600	0.12	0.24	30,000	1,800	0.12	0.36	18,000	1,400	0.1	0.2
2016-080			8	30,000	1,700	0.15	0.45	15,000	1,100	0.1	0.2	30,000	1,500	0.12	0.24	13,500	1,000	0.08	0.24
2016-120			12	23,000	1,200	0.1	0.3	11,000	700	0.06	0.18	18,000	1,000	0.06	0.18	12,500	650	0.04	0.16
2016-160	16		15,000	800	0.05	0.2	10,000	530	0.034	0.13	10,000	530	0.035	0.14	9,000	420	0.02	0.1	
2016-200	20		11,000	580	0.034	0.17	9,400	490	0.025	0.12	8,500	400	0.018	0.09	7,800	380	0.014	0.07	
2018-040	4		30,000	2,000	0.18	0.54	30,000	1,800	0.16	0.32	30,000	1,900	0.16	0.48	16,000	1,300	0.14	0.28	
2018-060	6		30,000	1,800	0.18	0.52	24,000	1,500	0.15	0.29	30,000	1,700	0.16	0.4	14,000	1,200	0.13	0.27	
2018-080	8		30,000	1,800	0.17	0.5	18,000	1,200	0.13	0.26	30,000	1,700	0.16	0.32	12,000	1,000	0.11	0.26	
2018-100	10	30,000	1,800	0.16	0.48	15,000	1,100	0.11	0.23	24,000	1,400	0.12	0.28	12,000	900	0.09	0.23		
2018-120	12	24,000	1,450	0.12	0.36	13,000	1,000	0.08	0.2	18,000	1,100	0.09	0.23	12,000	750	0.07	0.21		
2018-160	R0.9	16	15,000	900	0.07	0.3	12,000	750	0.05	0.18	15,000	750	0.04	0.14	9,500	480	0.025	0.11	
2018-180		18	13,000	800	0.06	0.24	11,000	650	0.04	0.16	11,000	600	0.035	0.14	8,800	440	0.02	0.1	
2018-200		20	11,500	650	0.05	0.2	9,500	600	0.03	0.15	8,500	450	0.025	0.11	8,300	420	0.018	0.08	
2018-220		22	10,000	590	0.035	0.18	8,500	550	0.03	0.14	8,000	400	0.02	0.1	7,800	400	0.015	0.075	
2018-250		25	8,000	500	0.035	0.17	8,000	480	0.025	0.12	7,000	350	0.018	0.09	7,000	350	0.012	0.06	
2018-300		30	7,500	450	0.025	0.13	7,500	420	0.02	0.08	6,500	280	0.014	0.07	6,500	280	0.008	0.04	

- φ3mm Shank V Series
- UDC-PCD Series
- CBN Series
- Square
- Long Neck Square
- Radius
- Long Neck Radius
- Taper Neck Radius
- Ball / Long Shank Ball
- Long Neck Ball
- Taper Neck Ball
- Taper
- Barrel
- Spiral V Cutter
- Drill
- Technical Data

Milling Conditions for CSELB

WORK MATERIAL		COPPER / ALUMINUM ALLOYS					CARBON STEELS / ALLOY STEELS S45C / S50C / SK / SCM (~325HB)					PREHARDENED STEELS NAK80 / STAVAX / HPM38 (30~45HRC)				HARDENED STEELS STAVAX / HPM38 / SKD61 (45~55HRC)			
Model Number	Radius of Ball Nose (mm)	Effective Length (mm)	Spindle Speed (min ⁻¹)	Feed Rate (mm/min)	a _p Axial Depth (mm)	a _e Radial Depth (mm)	Spindle Speed (min ⁻¹)	Feed Rate (mm/min)	a _p Axial Depth (mm)	a _e Radial Depth (mm)	Spindle Speed (min ⁻¹)	Feed Rate (mm/min)	a _p Axial Depth (mm)	a _e Radial Depth (mm)	Spindle Speed (min ⁻¹)	Feed Rate (mm/min)	a _p Axial Depth (mm)	a _e Radial Depth (mm)	
2020-030	R1	3	30,000	2,000	0.2	0.6	30,000	2,000	0.21	0.42	30,000	2,000	0.2	0.6	16,000	1,300	0.17	0.5	
2020-040		4	30,000	2,000	0.2	0.6	30,000	2,000	0.21	0.42	30,000	2,000	0.2	0.6	16,000	1,300	0.17	0.5	
2020-060		6	30,000	2,000	0.2	0.6	30,000	2,000	0.21	0.42	30,000	2,000	0.2	0.6	14,000	1,100	0.15	0.4	
2020-080		8	30,000	2,000	0.2	0.6	30,000	2,000	0.18	0.36	30,000	2,000	0.16	0.56	12,000	950	0.12	0.4	
2020-100		10	30,000	2,000	0.2	0.6	30,000	2,000	0.14	0.42	30,000	2,000	0.13	0.45	10,800	850	0.1	0.4	
2020-120		12	30,000	2,000	0.18	0.54	30,000	2,000	0.12	0.36	30,000	2,000	0.1	0.35	10,800	850	0.08	0.32	
2020-130		13	26,000	1,700	0.17	0.52	26,000	1,700	0.11	0.34	25,000	1,600	0.09	0.3	10,800	850	0.07	0.28	
2020-140		14	22,000	1,450	0.15	0.5	22,000	1,450	0.11	0.33	20,000	1,300	0.08	0.24	10,800	850	0.06	0.24	
2020-160		16	15,000	1,000	0.1	0.4	15,000	1,000	0.07	0.28	10,800	700	0.06	0.18	10,800	600	0.03	0.15	
2020-180		18	13,500	900	0.08	0.32	13,500	900	0.06	0.24	9,700	600	0.05	0.15	9,700	520	0.025	0.12	
2020-200		20	12,000	800	0.07	0.28	12,000	800	0.05	0.2	8,650	500	0.04	0.16	8,650	450	0.02	0.1	
2020-220		22	10,500	700	0.05	0.25	10,500	700	0.04	0.2	8,200	470	0.03	0.12	8,200	440	0.018	0.09	
2020-250		25	9,000	600	0.04	0.2	9,000	600	0.035	0.17	7,800	440	0.025	0.1	7,800	440	0.016	0.08	
2020-270		27	8,000	530	0.037	0.18	8,000	530	0.032	0.16	7,400	390	0.022	0.09	7,400	390	0.013	0.06	
2020-300		30	7,000	470	0.035	0.17	7,000	470	0.03	0.15	7,000	350	0.02	0.08	7,000	350	0.01	0.05	
2020-320		32	6,750	450	0.032	0.16	6,750	450	0.027	0.13	6,550	300	0.017	0.07	6,550	300	0.009	0.04	
2020-350		35	6,500	430	0.03	0.15	6,500	430	0.025	0.12	6,150	250	0.015	0.06	6,150	250	0.008	0.04	
2020-400		40	6,500	430	0.02	0.1	6,500	430	0.02	0.1	5,250	150	0.01	0.05	5,250	150	0.006	0.03	
2025-060		R1.25	6	27,000	2,300	0.28	0.75	27,000	2,300	0.25	0.5	27,000	2,300	0.25	0.75	13,000	1,100	0.21	0.63
2025-080			8	27,000	2,300	0.28	0.75	27,000	2,300	0.25	0.5	27,000	2,300	0.25	0.75	13,000	1,100	0.21	0.63
2025-100	10		25,000	2,100	0.26	0.67	25,000	2,100	0.23	0.46	24,000	2,200	0.2	0.65	11,000	930	0.14	0.44	
2025-150	15		22,000	1,950	0.23	0.59	22,000	1,950	0.15	0.45	20,000	1,600	0.13	0.42	9,000	720	0.08	0.32	
2025-200	20		11,000	1,150	0.14	0.38	11,000	1,150	0.1	0.3	8,000	600	0.06	0.24	7,600	470	0.04	0.12	
2025-250	25		8,300	1,000	0.09	0.27	8,300	1,000	0.06	0.24	6,200	450	0.045	0.18	5,800	400	0.03	0.1	
2025-300	30		7,000	700	0.06	0.24	7,000	700	0.05	0.2	5,000	380	0.03	0.12	4,800	360	0.022	0.088	
2025-350	35		5,500	530	0.04	0.2	5,500	530	0.035	0.17	4,200	300	0.025	0.1	4,200	270	0.015	0.06	
2030-060	R1.5		6	24,000	2,500	0.32	0.9	24,000	2,500	0.32	0.9	24,000	2,500	0.3	0.9	14,000	1,400	0.25	0.76
2030-080			8	24,000	2,500	0.32	0.9	24,000	2,500	0.32	0.9	24,000	2,500	0.3	0.9	14,000	1,400	0.25	0.76
2030-100		10	22,000	2,300	0.28	0.8	22,000	2,300	0.28	0.8	24,000	2,500	0.25	0.75	13,000	1,200	0.25	0.76	
2030-120		12	22,000	2,300	0.28	0.7	22,000	2,300	0.28	0.7	20,000	2,100	0.2	0.65	10,700	1,000	0.18	0.54	
2030-140		14	20,000	2,100	0.24	0.6	20,000	2,100	0.24	0.6	18,000	1,850	0.18	0.5	9,400	800	0.16	0.48	
2030-150		15	20,000	2,100	0.24	0.6	20,000	2,100	0.24	0.6	17,000	1,750	0.17	0.5	9,200	750	0.14	0.42	
2030-160		16	20,000	2,100	0.24	0.6	20,000	2,100	0.24	0.6	16,000	1,650	0.16	0.5	9,000	700	0.14	0.42	
2030-180		18	17,000	1,950	0.22	0.5	17,000	1,950	0.22	0.5	13,500	1,300	0.14	0.43	8,000	650	0.12	0.36	
2030-200		20	14,000	1,800	0.2	0.45	14,000	1,800	0.2	0.45	11,000	1,000	0.12	0.36	7,000	600	0.1	0.3	
2030-220		22	11,000	1,500	0.18	0.38	11,000	1,500	0.18	0.38	8,700	750	0.1	0.3	6,300	490	0.08	0.24	
2030-250		25	8,000	1,250	0.16	0.32	8,000	1,250	0.16	0.32	6,400	510	0.08	0.24	5,600	390	0.06	0.18	
2030-270		27	7,000	1,100	0.13	0.31	7,000	1,100	0.13	0.31	5,500	480	0.06	0.22	4,700	380	0.05	0.15	
2030-300		30	6,000	1,000	0.1	0.3	6,000	1,000	0.1	0.3	4,600	450	0.05	0.2	3,900	370	0.04	0.12	
2030-320		32	5,700	900	0.085	0.29	5,700	900	0.085	0.29	3,900	380	0.045	0.18	3,400	320	0.035	0.11	
2030-350		35	5,500	800	0.07	0.28	5,500	800	0.07	0.28	3,300	320	0.04	0.16	2,900	270	0.03	0.1	
2030-400		40	4,500	700	0.05	0.25	4,500	700	0.05	0.25	2,700	240	0.03	0.12	2,300	210	0.02	0.08	

Ø3mm Shank
V SeriesUDC-PCD
SeriesCBN
SeriesSquare
Long Neck
Square

Radius

Long Neck
RadiusTaper Neck
RadiusBall / Long
Shank BallLong Neck
BallTaper Neck
Ball

Taper

Barrel

Spiral
V Cutter

Drill

Technical Data

Milling Conditions for CSELB

WORK MATERIAL			COPPER / ALUMINUM ALLOYS				CARBON STEELS / ALLOY STEELS S45C / S50C / SK / SCM (~325HB)				PREHARDENED STEELS NAK80 / STAVAX / HPM38 (30~45HRC)				HARDENED STEELS STAVAX / HPM38 / SKD61 (45~55HRC)			
Model Number	Radius of Ball Nose (mm)	Effective Length (mm)	Spindle Speed (min ⁻¹)	Feed Rate (mm/min)	a _p Axial Depth (mm)	a _e Radial Depth (mm)	Spindle Speed (min ⁻¹)	Feed Rate (mm/min)	a _p Axial Depth (mm)	a _e Radial Depth (mm)	Spindle Speed (min ⁻¹)	Feed Rate (mm/min)	a _p Axial Depth (mm)	a _e Radial Depth (mm)	Spindle Speed (min ⁻¹)	Feed Rate (mm/min)	a _p Axial Depth (mm)	a _e Radial Depth (mm)
2035-100	R1.75	10	24,000	2,700	0.35	1	24,000	2,700	0.35	1	21,000	2,400	0.35	1	12,000	1,700	0.3	0.9
2035-150		15	20,000	2,200	0.29	0.8	20,000	2,200	0.29	0.8	17,000	2,000	0.25	0.7	9,100	1,000	0.19	0.57
2035-200		20	15,000	1,800	0.24	0.6	15,000	1,800	0.24	0.6	12,000	1,450	0.14	0.45	6,800	600	0.13	0.39
2035-250		25	10,000	1,600	0.2	0.47	10,000	1,600	0.2	0.47	8,500	950	0.12	0.34	6,000	540	0.09	0.27
2035-300		30	6,900	1,200	0.18	0.36	6,900	1,200	0.18	0.36	5,500	480	0.09	0.24	4,800	380	0.06	0.18
2035-400		40	4,500	780	0.07	0.3	4,500	780	0.07	0.3	3,000	310	0.04	0.18	2,800	260	0.035	0.11
2035-450		45	3,900	680	0.06	0.26	3,900	680	0.06	0.26	2,300	240	0.03	0.14	2,000	200	0.025	0.1
2040-080	R2	8	24,000	2,900	0.4	1.2	24,000	2,900	0.4	1.2	18,000	2,400	0.4	1.2	11,000	2,000	0.34	1
2040-100		10	24,000	2,900	0.4	1.2	24,000	2,900	0.4	1.2	18,000	2,400	0.4	1.2	11,000	2,000	0.34	1
2040-120		12	24,000	2,900	0.4	1.2	24,000	2,900	0.4	1.2	18,000	2,400	0.4	1.2	9,700	1,500	0.28	0.85
2040-140		14	21,000	2,630	0.35	1.1	21,000	2,630	0.35	1.1	15,000	2,150	0.3	1.1	9,700	1,200	0.28	0.8
2040-150		15	19,000	2,350	0.32	1	19,000	2,350	0.32	1	15,000	2,150	0.3	1	8,800	1,100	0.24	0.7
2040-160		16	18,000	2,250	0.3	1	18,000	2,250	0.3	1	15,000	2,150	0.3	0.9	8,000	1,000	0.2	0.6
2040-180		18	16,500	2,050	0.3	0.95	16,500	2,050	0.3	0.95	13,500	1,950	0.25	0.8	7,500	850	0.17	0.5
2040-200		20	15,000	1,900	0.3	0.9	15,000	1,900	0.3	0.9	12,000	1,750	0.2	0.7	7,000	750	0.15	0.45
2040-220		22	13,500	1,700	0.27	0.8	13,500	1,700	0.27	0.8	10,500	1,500	0.17	0.6	6,500	650	0.13	0.4
2040-250		25	12,000	1,550	0.25	0.7	12,000	1,550	0.25	0.7	9,000	1,300	0.15	0.5	6,000	560	0.12	0.36
2040-270		27	9,500	1,450	0.22	0.6	9,500	1,450	0.22	0.6	8,000	1,050	0.12	0.4	5,500	510	0.1	0.28
2040-300		30	7,000	1,400	0.2	0.5	7,000	1,400	0.2	0.5	7,000	850	0.1	0.3	5,000	460	0.08	0.2
2040-320		32	6,500	1,300	0.2	0.45	6,500	1,300	0.2	0.45	5,900	650	0.1	0.27	4,500	410	0.075	0.18
2040-350		35	6,000	1,200	0.2	0.4	6,000	1,200	0.2	0.4	4,800	450	0.1	0.25	4,000	370	0.07	0.17
2040-400		40	4,000	1,000	0.11	0.33	4,000	1,000	0.11	0.33	3,450	400	0.06	0.24	2,900	270	0.06	0.15
2040-450		45	3,800	760	0.08	0.32	3,800	760	0.08	0.32	2,700	300	0.05	0.2	2,300	240	0.04	0.12
2040-500	50	3,400	680	0.07	0.28	3,400	680	0.07	0.28	2,000	240	0.04	0.16	1,700	190	0.03	0.12	
2040-600	60	3,000	600	0.05	0.2	3,000	600	0.05	0.2	1,800	220	0.03	0.12	1,600	170	0.02	0.08	
2050-100	R2.5	10	18,000	3,000	0.5	1.5	18,000	3,000	0.5	1.5	13,750	2,400	0.45	1.4	8,800	1,800	0.42	1.2
2050-150		15	18,000	3,000	0.5	1.5	18,000	3,000	0.5	1.5	13,750	2,400	0.45	1.4	7,800	1,300	0.34	1
2050-200		20	14,000	2,600	0.37	1.2	15,600	2,600	0.37	1.2	12,000	1,800	0.36	1.1	6,300	830	0.27	0.75
2050-250		25	12,000	2,000	0.33	1.1	12,000	2,000	0.33	1.1	9,600	1,350	0.25	1	5,700	750	0.25	0.67
2050-300		30	9,600	1,800	0.31	0.9	9,600	1,800	0.31	0.9	8,400	1,100	0.23	0.8	5,000	650	0.2	0.5
2050-350		35	8,400	1,700	0.3	0.75	8,400	1,700	0.3	0.75	7,200	850	0.2	0.6	4,400	530	0.16	0.33
2050-400		40	5,500	1,500	0.25	0.5	4,800	1,500	0.25	0.5	3,800	440	0.13	0.35	3,300	390	0.09	0.22
2050-450		45	4,000	1,200	0.2	0.42	4,000	1,200	0.2	0.42	3,300	400	0.11	0.3	2,800	330	0.08	0.18
2050-500		50	3,200	1,000	0.16	0.37	3,200	1,000	0.16	0.37	2,750	350	0.08	0.27	2,350	270	0.07	0.15
2060-100	R3	10	16,000	3,100	0.6	1.8	16,000	3,100	0.6	1.8	11,000	2,310	0.55	1.7	7,500	1,800	0.5	1.5
2060-150		15	16,000	3,100	0.6	1.8	16,000	3,100	0.6	1.8	11,000	2,310	0.55	1.7	7,500	1,800	0.5	1.5
2060-180		18	16,000	3,100	0.6	1.8	16,000	3,100	0.6	1.8	11,000	2,310	0.55	1.7	7,000	1,500	0.45	1.45
2060-200		20	16,000	3,100	0.6	1.8	16,000	3,100	0.6	1.8	11,000	2,310	0.55	1.7	6,500	1,300	0.4	1.4
2060-220		22	14,500	2,850	0.52	1.6	14,500	2,850	0.52	1.6	10,500	2,050	0.47	1.5	5,900	1,050	0.36	1.1
2060-250		25	13,000	2,600	0.45	1.5	13,000	2,600	0.45	1.5	10,000	1,800	0.4	1.3	5,300	840	0.32	0.9
2060-270		27	11,500	2,350	0.42	1.4	11,500	2,350	0.42	1.4	9,000	1,550	0.35	1.2	5,000	790	0.31	0.85
2060-300		30	10,000	2,100	0.4	1.3	10,000	2,100	0.4	1.3	8,000	1,350	0.3	1.1	4,700	750	0.3	0.8
2060-320		32	9,000	1,950	0.39	1.2	9,000	1,950	0.39	1.2	7,500	1,200	0.28	1	4,400	710	0.27	0.7
2060-350		35	8,000	1,800	0.38	1.1	8,000	1,800	0.38	1.1	7,000	1,100	0.26	0.9	4,200	670	0.25	0.6
2060-400		40	7,000	1,800	0.36	0.9	7,000	1,800	0.36	0.9	6,000	900	0.23	0.75	3,700	550	0.2	0.4
2060-450		45	5,800	1,700	0.33	0.75	5,800	1,700	0.33	0.75	4,600	670	0.19	0.6	3,200	470	0.15	0.3
2060-500		50	4,000	1,500	0.3	0.6	4,000	1,500	0.3	0.6	3,200	450	0.15	0.4	2,800	400	0.1	0.2
2060-600		60	2,700	1,000	0.21	0.42	2,700	1,000	0.21	0.42	2,300	320	0.1	0.3	1,950	270	0.08	0.16

φ3mm Shank V Series

UDC-PCD Series

CBN Series

Square
Long Neck Square

Radius

Long Neck Radius
Taper Neck Radius

Ball / Long Shank Ball
Long Neck Ball

Taper Neck Ball

Taper

Barrel

Spiral V Cutter

Drill

Technical Data

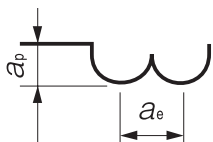

- Note:
- Decrease the feed rate more than 50% from the milling parameters when slot milling.
 - Decrease both spindle speed and feed rate proportionally when the milling parameters exceed the machines maximum speed, or when the tool is chattering and heats up to a red color.
 - Recommend oil coolant for Stainless Steels and Heat Resistant Alloys.
 - Recommend wet coolant for Copper.

∅3mm Shank
V Series

UDC-PCD
Series

CBN
Series

Square

Square

Long Neck
Square

Radius

Radius

Long Neck
Radius

Taper Neck
Radius

Ball

Ball / Long
Shank Ball

Long Neck
Ball

Taper Neck
Ball

Taper

Taper

Barrel

Spiral

V Cutter

Drill

Technical Data



Size R0.2~R3

DCLB



Material Applications (★ Highly Recommended ● Recommended ○ Suggested)

Work Material																	
Carbon Steels S45C S55C	Alloy Steels SK / SCM SUS	Prehardened Steels NAK HPM	Hardened Steels					Cast Iron	Aluminum Alloys	Graphite	Copper	Plastics	Glass Filled Plastics	Titanium Alloys	Heat Resistant Alloys	Cemented Carbide	Hard Brittle (Non-Metallic) Materials
			~50HRC	~55HRC	~60HRC	~65HRC	~70HRC										
									○	★	○	○	●				○

Features

Diamond coated 2 flute long neck ball end mills for Graphite Electrodes.

A highly adhesive coating base, offers long tool life and excellent wear resistance.

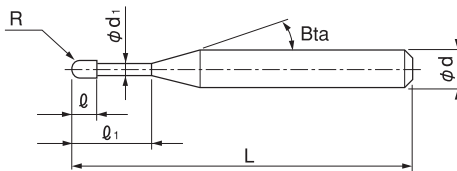

The shank taper angle shown is not an exact value and to avoid contact with the work piece, we recommend the user controls the precise value of this angle. Shank taper angle should not make contact with the work piece.

Total 68 models

Unit (mm)

Model Number	Radius of Ball Nose R	Effective Length l_1	Length of Cut l	Neck Diameter ϕd_1	Shank Taper Angle Bta	Overall Length L	Shank Diameter ϕd	Suggested Retail Price ¥	Effective Length by Inclined Angles				
									30°	1°	1° 30'	2°	3°
DCLB 2004-0020	R0.2	2	0.32	0.37	16°	45	4	13,000	2.24	2.41	2.54	2.65	2.85
DCLB 2004-0030		3				45	4	13,000	3.33	3.52	3.67	3.80	4.08
DCLB 2004-0040		4				45	4	13,000	4.39	4.61	4.78	4.94	5.30
DCLB 2004-0050		5				45	4	13,000	5.45	5.69	5.88	6.08	6.52
DCLB 2005-0020	R0.25	2	0.4	0.47	16°	45	4	13,000	2.29	2.49	2.64	2.78	3.01
DCLB 2005-0030		3				45	4	13,000	3.39	3.61	3.79	3.95	4.24
DCLB 2005-0060		6				45	4	13,000	6.59	6.89	7.13	7.37	7.91
DCLB 2005-0100		10				45	4	13,000	10.78	11.16	11.53	11.93	12.80
DCLB 2006-0020	R0.3	2	0.48	0.57	16°	45	4	13,000	2.33	2.55	2.73	2.89	3.16
DCLB 2006-0030		3				45	4	13,000	3.44	3.70	3.90	4.08	4.40
DCLB 2006-0040		4				45	4	13,000	4.53	4.82	5.05	5.24	5.62
DCLB 2006-0060		6				45	4	13,000	6.67	7.01	7.28	7.52	8.07
DCLB 2006-0100		10				45	4	13,000	10.89	11.31	11.68	12.08	12.96
DCLB 2006-0120		12				45	4	13,000	12.98	13.44	13.88	14.36	15.41
DCLB 2008-0100	R0.4	10	0.64	0.77	16°	45	4	13,000	10.88	11.30	11.67	12.07	12.94
DCLB 2008-0120		12				50	4	13,000	12.97	13.43	13.87	14.34	15.39
DCLB 2008-0160		16				50	4	13,000	17.13	17.69	18.27	18.90	20.28

Model Number	Radius of Ball Nose R	Effective Length ℓ ₁	Length of Cut ℓ	Neck Diameter φd	Shank Taper Angle Bta	Overall Length L	Shank Diameter φd	Suggested Retail Price ¥	Effective Length by Inclined Angles							
									30°	1°	1° 30'	2°	3°			
DCLB 2010-0030	RO.5	3	0.8	0.96	16°	45	4	13,000	3.45	3.69	3.89	4.06	4.37			
DCLB 2010-0050		5				45	4	13,000	5.61	5.91	6.16	6.37	6.81			
DCLB 2010-0060		6				45	4	13,000	6.67	7.01	7.27	7.51	8.04			
DCLB 2010-0080		8				45	4	13,000	8.79	9.17	9.47	9.78	10.48			
DCLB 2010-0100		10	1.5			60	4	13,000	10.89	11.31	11.67	12.06	12.93			
DCLB 2010-0100-08		10	0.8			45	4	13,000	10.89	11.31	11.67	12.06	12.93			
DCLB 2010-0120		12				50	4	13,000	12.98	13.44	13.87	14.34	15.38			
DCLB 2010-0160		16				50	4	13,000	17.14	17.70	18.27	18.89	20.27			
DCLB 2010-0200		20				1.5	60	4	13,000	21.28	21.95	22.68	23.45	25.17		
DCLB 2015-0060	RO.75	6	1.2	1.44	16°	45	4	15,000	6.14	6.32	6.51	6.71	7.16			
DCLB 2015-0100		10				45	4	15,000	10.27	10.58	10.91	11.27	12.06			
DCLB 2015-0160		16				50	4	15,000	16.46	16.97	17.51	18.10	19.40			
DCLB 2020-0040	R1	4	1.6	1.9	16°	45	4	13,000	4.13	4.23	4.34	4.46	4.73			
DCLB 2020-0060		6				45	4	13,000	6.19	6.36	6.54	6.74	7.17			
DCLB 2020-0080		8				45	4	13,000	8.25	8.49	8.74	9.02	9.62			
DCLB 2020-0100		10				45	4	13,000	10.31	10.62	10.94	11.29	12.07			
DCLB 2020-0120		12				45	4	13,000	12.38	12.75	13.15	13.57	14.52			
DCLB 2020-0160		16				50	4	13,000	16.50	17.01	17.55	18.12	19.41			
DCLB 2020-0200-16		20				60	4	13,000	20.63	21.27	21.95	22.68	No Interference			
DCLB 2020-0200		20				3	70	4	13,000	20.63	21.27	21.95	22.68	No Interference		
DCLB 2020-0250		25	1.6	65	4	13,000	25.79	26.59	27.45	28.37	No Interference					
DCLB 2020-0250-30		25	3	65	4	13,000	25.79	26.59	27.45	28.37	No Interference					
DCLB 2020-0300-16		30	1.6	70	4	13,000	30.94	31.92	32.95	No Interference	No Interference					
DCLB 2020-0300		30	3	70	4	13,000	30.94	31.92	32.95	No Interference	No Interference					
DCLB 2020-0350		35	1.91	16°	1.91	16°	70	4	13,000	36.09	37.23	38.45	No Interference	No Interference		
DCLB 2020-0400		40					80	4	13,500	41.25	42.55	No Interference	No Interference	No Interference		
DCLB 2030-0160		R1.5	16	2.4	2.9	16°	60	6	15,000	16.49	16.98	17.50	18.06	19.30		
DCLB 2030-0200			20				60	6	15,000	20.61	21.23	21.90	22.61	24.20		
DCLB 2030-0250	25		70				6	17,000	25.77	26.56	27.40	28.30	30.31			
DCLB 2030-0300	30		4.5	80			4	13,500	30.93	No Interference	No Interference	No Interference	No Interference			
DCLB 2030-0300-S6	30		2.4	80			6	17,000	30.93	31.88	32.90	34.00	No Interference			
DCLB 2030-0400-S6	40			80			6	18,500	41.24	42.53	43.91	No Interference	No Interference			
DCLB 2030-0400	40		4.5	80			4	15,000	41.24	No Interference	No Interference	No Interference	No Interference			
DCLB 2040-0160	R2		16	3.2			3.9	16°	70	6	16,500	16.47	16.94	17.45	17.99	19.19
DCLB 2040-0200			20						70	6	16,500	20.60	21.20	21.85	22.54	No Interference
DCLB 2040-0250		25	70		6	16,500			25.75	26.53	27.35	28.24	No Interference			
DCLB 2040-0300		30	70		6	16,500			30.91	31.85	32.85	No Interference	No Interference			
DCLB 2040-0300-60		30	6		100	4			18,500	No Interference	No Interference	No Interference	No Interference	No Interference		
DCLB 2040-0400-S6		40	3.2	16°	90	6		18,500	41.22	42.50	No Interference	No Interference	No Interference			
DCLB 2040-0400		40	6	100	4	18,500		No Interference	No Interference	No Interference	No Interference	No Interference				
DCLB 2040-0500-S6		50	3.2	16°	100	6		19,800	51.54	53.15	No Interference	No Interference	No Interference			
DCLB 2040-0500		50	6	100	4	19,000		No Interference	No Interference	No Interference	No Interference	No Interference				
DCLB 2040-0600		60		3.91	100	4		19,000	No Interference	No Interference	No Interference	No Interference	No Interference			
DCLB 2050-0200	R2.5	20	4	4.8	16°	70	6	16,500	20.76	21.36	21.99	No Interference	No Interference			
DCLB 2050-0300		30				80	6	17,000	31.08	32.00	No Interference	No Interference	No Interference			
DCLB 2060-0300	R3	30	4.8	5.7	-	80	6	17,000	No Interference	No Interference	No Interference	No Interference	No Interference			
DCLB 2060-0400		40				100	6	19,800	No Interference	No Interference	No Interference	No Interference	No Interference			
DCLB 2060-0500		50				120	6	19,800	No Interference	No Interference	No Interference	No Interference	No Interference			
DCLB 2060-0600		60				120	6	23,000	No Interference	No Interference	No Interference	No Interference	No Interference			
DCLB 2060-0700		70				5.71	-	120	6	23,000	No Interference	No Interference	No Interference	No Interference	No Interference	
DCLB 2060-0800		80						120	6	25,300	No Interference	No Interference	No Interference	No Interference	No Interference	

- φ3mm Shank V Series
- UDC-PCD Series
- CBN Series
- Square
- Square Long Neck Square
- Radius
- Radius Long Neck Radius
- Taper Neck Radius
- Ball
- Ball / Long Shank Ball
- Ball Long Neck Ball
- Taper Neck Ball
- Taper
- Taper Taper
- Barrel
- Spiral V Cutter
- Drill
- Technical Data

Milling Conditions for DCLB

WORK MATERIAL			GRAPHITE			
Model Number	Radius of Ball Nose (mm)	Effective Length (mm)	Spindle Speed (min ⁻¹)	Feed Rate (mm/min)	a _p Axial Depth (mm)	a _e Radial Depth (mm)
2004-0020	R0.2	2	33,500	1,100	0.1	0.04
2004-0030		3	33,500	1,100	0.09	0.04
2004-0040		4	33,500	1,100	0.08	0.04
2004-0050		5	33,500	1,100	0.06	0.04
2005-0020		R0.25	2	33,500	1,200	0.11
2005-0030	3		33,500	1,200	0.1	0.05
2005-0060	6		33,500	1,200	0.07	0.05
2005-0100	10		33,500	1,200	0.03	0.05
2006-0020	R0.3	2	33,500	1,300	0.15	0.06
2006-0030		3	33,500	1,300	0.13	0.06
2006-0040		4	33,500	1,300	0.12	0.06
2006-0060		6	33,500	1,300	0.1	0.06
2006-0100		10	33,500	1,300	0.04	0.06
2006-0120	R0.4	12	33,500	1,300	0.04	0.06
2008-0100		10	33,500	1,400	0.13	0.08
2008-0120		12	33,500	1,400	0.1	0.08
2008-0160		16	33,500	1,400	0.08	0.08
2010-0030	R0.5	3	33,500	1,500	0.2	0.1
2010-0050		5	33,500	1,500	0.19	0.1
2010-0060		6	33,500	1,500	0.19	0.1
2010-0080		8	33,500	1,500	0.18	0.1
2010-0100(-08)		10	33,500	1,500	0.16	0.1
2010-0120		12	33,500	1,500	0.15	0.1
2010-0160		16	33,500	1,500	0.12	0.1
2010-0200	R0.75	20	33,500	1,500	0.1	0.1
2015-0060		6	30,000	1,500	0.35	0.15
2015-0100		10	30,000	1,500	0.3	0.15
2015-0160		16	30,000	1,500	0.25	0.15
2020-0040	R1	4	27,000	1,500	0.5	0.2
2020-0060		6	27,000	1,500	0.49	0.2
2020-0080		8	27,000	1,500	0.48	0.2
2020-0100		10	27,000	1,500	0.46	0.2
2020-0120		12	27,000	1,500	0.43	0.2
2020-0160		16	27,000	1,500	0.38	0.2
2020-0200(-16)		20	27,000	1,500	0.24	0.2
2020-0250(-30)		25	27,000	1,500	0.19	0.2
2020-0300(-16)		30	27,000	1,500	0.12	0.2
2020-0350		35	27,000	1,500	0.11	0.2
2020-0400	40	27,000	1,500	0.09	0.2	

- Ø3mm Shank V Series
- UDC-PCD Series
- CBN Series
- Square
- Long Neck Square
- Radius
- Long Neck Radius
- Taper Neck Radius
- Ball / Long Shank Ball
- Long Neck Ball
- Taper Neck Ball
- Taper
- Barrel
- Spiral V Cutter
- Drill
- Technical Data

Milling Conditions for DCLB

WORK MATERIAL			GRAPHITE				
Model Number	Radius of Ball Nose (mm)	Effective Length (mm)	Spindle Speed (min ⁻¹)	Feed Rate (mm/min)	a_p Axial Depth (mm)	a_e Radial Depth (mm)	
2030-0160	R1.5	16	18,000	1,650	0.5	0.45	
2030-0200		20	18,000	1,650	0.44	0.45	
2030-0250		25	18,000	1,650	0.36	0.45	
2030-0300(-S6)		30	18,000	1,650	0.3	0.45	
2030-0400(-S6)		40	18,000	1,650	0.2	0.45	
2040-0160		R2	16	13,500	1,750	0.7	0.6
2040-0200	20		13,500	1,750	0.65	0.6	
2040-0250	25		13,500	1,750	0.55	0.6	
2040-0300	30		13,500	1,750	0.5	0.6	
2040-0300(-60)	30		13,500	1,750	0.5	0.6	
2040-0400(-S6)	40		13,500	1,750	0.4	0.6	
2040-0500(-S6)	50		13,500	1,750	0.24	0.6	
2040-0600	60		13,500	1,750	0.18	0.6	
2050-0200	R2.5		20	10,800	1,600	0.8	0.75
2050-0300			30	10,800	1,600	0.6	0.75
2060-0300	R3	30	9,000	1,400	0.9	0.9	
2060-0400		40	9,000	1,400	0.75	0.9	
2060-0500		50	9,000	1,400	0.6	0.9	
2060-0600		60	9,000	1,400	0.51	0.9	
2060-0700		70	9,000	1,400	0.4	0.9	
2060-0800		80	9,000	1,400	0.23	0.9	

Note:

- Use a milling machine dedicated for Graphite.
- Decrease the feed rate more than 50% from the milling parameters when slot milling.
- Recommend air blow for Graphite.

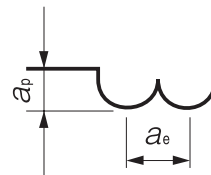

Ø3mm Shank
V Series

UDC-PCD
Series

CBN
Series

Square

Long Neck
Square

Radius

Long Neck
Radius

Taper Neck
Radius

Ball / Long
Shank Ball

Long Neck
Ball

Taper Neck
Ball

Taper

Barrel

Spiral
V Cutter

Drill

Technical Data



Size R0.05~R3

DLCLB



R0.05~R0.2 R0.25~R2 R3

Back taper geometry does not apply to R0.15 or below.

Material Applications (★ Highly Recommended ● Recommended ○ Suggested)

Work Material																	
Carbon Steels	Alloy Steels	Prehardened Steels	Hardened Steels					Cast Iron	Aluminum Alloys	Graphite	Copper	Plastics	Glass Filled Plastics	Titanium Alloys	Heat Resistant Alloys	Cemented Carbide	Hard Brittle (Non-Metallic) Materials
			~50HRC	~55HRC	~60HRC	~65HRC	~70HRC										
S45C S55C	SK / SCM SUS	NAK HPM															
								●		★							

φ3mm Shank V Series

UDC-PCD Series

CBN Series

Square
Long Neck Square

Radius

Long Neck Radius

Taper Neck Radius

Ball / Long Shank Ball

Long Neck Ball

Taper Neck Ball

Taper

Barrel

Spiral V Cutter

Drill

Technical Data

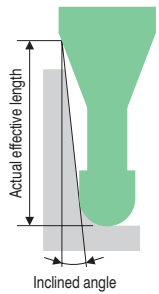
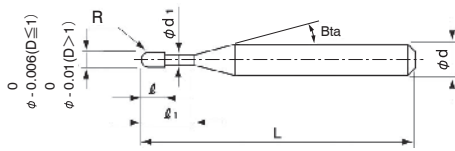

Label Sample



#001 φD0.597 R+0.001/-0.001

Diameter and Ball Radius accuracy measurements are printed on the label to support High Precision milling.

The shank taper work angle shown is not an exact value and to avoid contact with the work piece, we recommend the user controls the precise value of this angle. Shank taper angle should not make contact with the work piece.

Total 71 models

Model Number	Radius of Ball Nose R	Effective Length l_1	Length of Cut l	Neck Diameter ϕ_{d1}	Shank Taper Angle Bta	Overall Length L	Shank Diameter ϕ_d	Suggested Retail Price ¥
DLCLB 2001-003	R0.05	0.3	0.08	0.095	11°	45	4	10,600
DLCLB 2001-005		0.5				45	4	11,000
DLCLB 20015-003	R0.075	0.3	0.12	0.14	11°	45	4	11,700
DLCLB 20015-005		0.5				45	4	12,400
DLCLB 20015-010		1				45	4	12,900
DLCLB 2002-003	R0.1	0.3	0.16	0.19	11°	45	4	8,500
DLCLB 2002-005		0.5				45	4	8,500
DLCLB 2002-010		1				45	4	8,900
DLCLB 2002-015		1.5				45	4	9,200

Best wedge angle for copper milling

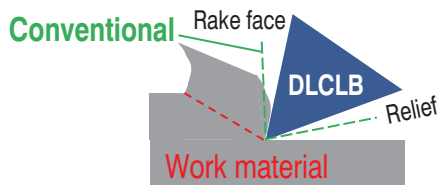

Wedge angle
DLCLB < Conventional

Near Diamond hardness DLC coating

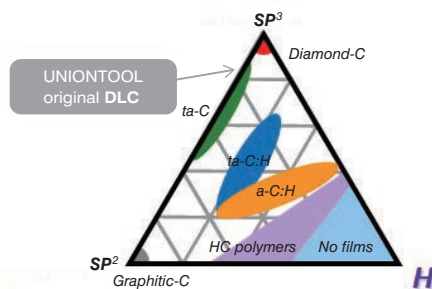

The hard DLC was developed by our in-house coating furnace.

High accuracy

Tolerance settings that enable high accuracy milling (mm)

Ball Radius Accuracy	$D \leq R0.5$	$D > R0.5$	
Diameter Tolerance	0/-0.006	0/-0.01	
Ball Radius Accuracy	R0.05 ~ R0.2	R0.25 ~ R2	R3
Radius Accuracy	± 0.002	± 0.003	± 0.004
Shank Diameter Tolerance	0/-0.004		

Model Number	Radius of Ball Nose R	Effective Length l_1	Effective Length by Inclined Angles				
			30'	1°	1° 30'	2°	3°
DLCLB 2001-003	R0.05	0.3	0.34	0.36	0.39	0.41	0.46
DLCLB 2001-005		0.5	0.55	0.59	0.62	0.65	0.73
DLCLB 20015-003	R0.075	0.3	0.36	0.38	0.40	0.42	0.47
DLCLB 20015-005		0.5	0.57	0.60	0.63	0.66	0.74
DLCLB 20015-010		1	1.09	1.15	1.21	1.27	1.43
DLCLB 2002-003		R0.1	0.3	0.41	0.43	0.45	0.47
DLCLB 2002-005	0.5		0.62	0.65	0.68	0.72	0.80
DLCLB 2002-010	1		1.14	1.20	1.26	1.33	1.49
DLCLB 2002-015	1.5		1.67	1.75	1.84	1.94	2.17

Unit (mm)

Next Page →

Ø3mm Shank
V Series

UDC-PCD
Series

CBN
Series

Square

Long Neck
Square

Radius

Long Neck
Radius

Taper Neck
Radius

Ball / Long
Shank Ball

Long Neck
Ball

Taper Neck
Ball

Taper

Barrel

Spiral
V Cutter

Drill

Technical Data

2 Flutes DLC for Copper Electrode

Model Number	Radius of Ball Nose R	Effective Length ℓ_1	Length of Cut ℓ	Neck Diameter ϕd_1	Shank Taper Angle B α	Overall Length L	Shank Diameter ϕd	Suggested Retail Price ¥
DLCLB 2003-006	RO.15	0.6	0.24	0.29	11°	45	4	8,900
DLCLB 2003-010		1				45		8,900
DLCLB 2003-015		1.5				45		9,200
DLCLB 2003-020		2				45		9,600
DLCLB 2004-010	RO.2	1	0.32	0.39	11°	45	4	7,700
DLCLB 2004-020		2				45		7,900
DLCLB 2004-030		3				45		8,000
DLCLB 2004-040		4				45		8,200
DLCLB 2005-010	RO.25	1	0.4	0.49	11°	45	4	7,600
DLCLB 2005-020		2				45		7,600
DLCLB 2005-030		3				45		7,700
DLCLB 2005-040		4				45		7,900
DLCLB 2005-050		5				45		8,000
DLCLB 2006-010	RO.3	1	0.48	0.59	11°	45	4	5,900
DLCLB 2006-020		2				45		5,900
DLCLB 2006-030		3				45		6,100
DLCLB 2006-040		4				45		6,200
DLCLB 2006-050		5				45		6,400
DLCLB 2006-060		6				45		6,500
DLCLB 2008-020	RO.4	2	0.64	0.79	11°	45	4	6,100
DLCLB 2008-030		3				45		6,100
DLCLB 2008-040		4				45		6,200
DLCLB 2008-060		6				45		6,400
DLCLB 2008-080		8				45		6,500
DLCLB 2010-020	RO.5	2	0.8	0.98	11°	45	4	5,800
DLCLB 2010-030		3				45		5,800
DLCLB 2010-040		4				45		5,800
DLCLB 2010-050		5				45		5,900
DLCLB 2010-060		6				45		5,900
DLCLB 2010-080		8				45		6,200
DLCLB 2010-100		10				45		6,200
DLCLB 2010-120		12				45		6,200

φ3mm Shank
V Series

UDC-PCD
Series

CBN
Series

Square

Long Neck
Square

Radius

Long Neck
Radius

Taper Neck
Radius

Ball / Long
Shank Ball

Long Neck
Ball

Taper Neck
Ball

Taper

Barrel

Spiral
V Cutter

Drill

Technical Data

Model Number	Radius of Ball Nose R	Effective Length l_1	Effective Length by Inclined Angles				
			30'	1°	1° 30'	2°	3°
DLCLB 2003-006	RO.15	0.6	0.72	0.75	0.79	0.83	0.92
DLCLB 2003-010		1	1.14	1.19	1.25	1.32	1.47
DLCLB 2003-015		1.5	1.67	1.74	1.83	1.93	2.15
DLCLB 2003-020		2	2.19	2.29	2.41	2.53	2.84
DLCLB 2004-010	RO.2	1	1.14	1.19	1.24	1.30	1.45
DLCLB 2004-020		2	2.19	2.29	2.40	2.52	2.82
DLCLB 2004-030		3	3.23	3.39	3.56	3.74	4.19
DLCLB 2004-040		4	4.28	4.49	4.71	4.96	5.56
DLCLB 2005-010	RO.25	1	1.14	1.18	1.24	1.29	1.43
DLCLB 2005-020		2	2.18	2.28	2.39	2.51	2.80
DLCLB 2005-030		3	3.23	3.38	3.55	3.73	4.17
DLCLB 2005-040		4	4.28	4.48	4.70	4.95	5.54
DLCLB 2005-050		5	5.33	5.58	5.86	6.17	6.91
DLCLB 2006-010	RO.3	1	1.14	1.18	1.23	1.28	1.41
DLCLB 2006-020		2	2.18	2.28	2.38	2.50	2.78
DLCLB 2006-030		3	3.23	3.38	3.54	3.72	4.15
DLCLB 2006-040		4	4.28	4.48	4.70	4.94	5.52
DLCLB 2006-050		5	5.32	5.57	5.85	6.16	6.89
DLCLB 2006-060		6	6.37	6.67	7.01	7.38	8.26
DLCLB 2008-020	RO.4	2	2.18	2.27	2.37	2.48	2.75
DLCLB 2008-030		3	3.22	3.37	3.52	3.70	4.12
DLCLB 2008-040		4	4.27	4.47	4.68	4.92	5.48
DLCLB 2008-060		6	6.37	6.66	6.99	7.36	8.22
DLCLB 2008-080		8	8.46	8.86	9.30	9.79	10.96
DLCLB 2010-020	RO.5	2	2.19	2.28	2.37	2.48	2.73
DLCLB 2010-030		3	3.24	3.37	3.53	3.70	4.10
DLCLB 2010-040		4	4.28	4.47	4.68	4.92	5.47
DLCLB 2010-050		5	5.33	5.57	5.84	6.14	6.84
DLCLB 2010-060		6	6.38	6.67	6.99	7.35	8.21
DLCLB 2010-080		8	8.47	8.87	9.31	9.79	10.95
DLCLB 2010-100		10	10.57	11.07	11.62	12.23	13.68
DLCLB 2010-120		12	12.66	13.26	13.93	14.67	16.42

Ø3mm Shank
V Series

UDC-PCD
Series

CBN
Series

Square

Long Neck
Square

Radius

Long Neck
Radius

Taper Neck
Radius

Ball / Long
Shank Ball

Long Neck
Ball

Taper Neck
Ball

Taper

Barrel

Spiral
V Cutter

Drill

Technical Data

2 Flutes DLC for Copper Electrode

Model Number	Radius of Ball Nose R	Effective Length ℓ_1	Length of Cut ℓ	Neck Diameter ϕd_1	Shank Taper Angle B _{ta}	Overall Length L	Shank Diameter ϕd	Suggested Retail Price ¥
DLCLB 2015-040	R0.75	4	1.2	1.47	11°	45	4	5,900
DLCLB 2015-060		6				45	4	5,900
DLCLB 2015-120		12				50	4	6,700
DLCLB 2015-180		18				55	4	7,400
DLCLB 2020-040	R1	4	1.6	1.98	11°	45	4	6,100
DLCLB 2020-060		6				45	4	6,100
DLCLB 2020-080		8				45	4	6,200
DLCLB 2020-100		10				45	4	6,200
DLCLB 2020-120		12				50	4	6,200
DLCLB 2020-140		14				50	4	6,200
DLCLB 2020-160		16				50	4	6,200
DLCLB 2020-200		20				55	4	6,900
DLCLB 2020-250		25				65	4	7,700
DLCLB 2030-100		R1.5				10	2.4	2.95
DLCLB 2030-120	12		60	6	8,100			
DLCLB 2030-140	14		60	6	8,100			
DLCLB 2030-160	16		60	6	8,400			
DLCLB 2030-200	20		70	6	8,400			
DLCLB 2030-250	25		70	6	8,400			
DLCLB 2030-300	30		70	6	9,200			
DLCLB 2040-100	R2		10	3.2	3.95	11°		
DLCLB 2040-150		15	70				6	7,300
DLCLB 2040-200		20	70				6	8,600
DLCLB 2040-250		25	70				6	9,200
DLCLB 2040-300		30	70				6	9,500
DLCLB 2040-400		40	80				6	10,300
DLCLB 2060-100	R3	10	4.8	5.95	—	80	6	9,500
DLCLB 2060-150		15				80	6	9,500
DLCLB 2060-200		20				80	6	9,500
DLCLB 2060-300		30				80	6	10,000

φ3mm Shank V Series

UDC-PCD Series

CBN Series

Square
Long Neck Square

Radius
Long Neck Radius
Taper Neck Radius

Ball / Long Shank Ball
Long Neck Ball
Taper Neck Ball

Taper

Barrel

Spiral V Cutter

Drill

Technical Data

Unit (mm)

Model Number	Radius of Ball Nose R	Effective Length l_1	Effective Length by Inclined Angles				
			30'	1°	1° 30'	2°	3°
DLCLB 2015-040	R0.75	4	4.21	4.39	4.58	4.80	5.31
DLCLB 2015-060		6	6.31	6.59	6.89	7.23	8.04
DLCLB 2015-120		12	12.59	13.18	13.83	14.55	16.26
DLCLB 2015-180		18	18.87	19.77	20.76	21.86	24.47
DLCLB 2020-040	R1	4	4.18	4.34	4.51	4.71	5.18
DLCLB 2020-060		6	6.27	6.53	6.82	7.15	7.92
DLCLB 2020-080		8	8.36	8.73	9.14	9.59	10.66
DLCLB 2020-100		10	10.46	10.93	11.45	12.02	13.39
DLCLB 2020-120		12	12.55	13.12	13.76	14.46	16.13
DLCLB 2020-140		14	14.65	15.32	16.07	16.90	18.87
DLCLB 2020-160		16	16.74	17.52	18.38	19.34	No Interference
DLCLB 2020-200		20	20.93	21.91	23.00	24.21	No Interference
DLCLB 2020-250		25	26.16	27.41	28.78	No Interference	No Interference
DLCLB 2030-100		R1.5	10	10.51	10.96	11.46	12.01
DLCLB 2030-120	12		12.61	13.16	13.77	14.45	16.06
DLCLB 2030-140	14		14.70	15.36	16.08	16.89	18.80
DLCLB 2030-160	16		16.80	17.56	18.39	19.32	21.54
DLCLB 2030-200	20		20.98	21.95	23.02	24.20	27.01
DLCLB 2030-250	25		26.22	27.44	28.79	30.30	No Interference
DLCLB 2030-300	30		31.45	32.94	34.57	36.39	No Interference
DLCLB 2040-100	R2	10	10.49	10.91	11.38	11.90	13.14
DLCLB 2040-150		15	15.73	16.41	17.16	18.00	19.99
DLCLB 2040-200		20	20.96	21.90	22.94	24.09	No Interference
DLCLB 2040-250		25	26.20	27.39	28.72	30.19	No Interference
DLCLB 2040-300		30	31.43	32.89	34.50	No Interference	No Interference
DLCLB 2040-400		40	41.90	43.87	No Interference	No Interference	No Interference
DLCLB 2060-100	R3	10	No Interference	No Interference	No Interference	No Interference	No Interference
DLCLB 2060-150		15	No Interference	No Interference	No Interference	No Interference	No Interference
DLCLB 2060-200		20	No Interference	No Interference	No Interference	No Interference	No Interference
DLCLB 2060-300		30	No Interference	No Interference	No Interference	No Interference	No Interference

Ø3mm Shank
V SeriesUDC-PCD
SeriesCBN
SeriesSquare
Long Neck
SquareRadius
Long Neck
Radius
Taper Neck
RadiusBall / Long
Shank Ball
Long Neck
Ball
Taper Neck
BallTaper
Taper

Barrel

Spiral
V Cutter

Drill

Technical Data

Milling Conditions for DLCLB

WORK MATERIAL			COPPER / ALUMINUM ALLOYS				TUNGSTEN COPPER			
Model Number	Radius of Ball Nose (mm)	Effective Length (mm)	Spindle Speed (min ⁻¹)	Feed Rate (mm/min)	a _p Axial Depth (mm)	a _e Radial Depth (mm)	Spindle Speed (min ⁻¹)	Feed Rate (mm/min)	a _p Axial Depth (mm)	a _e Radial Depth (mm)
2001-003	R0.05	0.3	43,600	220	0.01	0.01	32,700	160	0.008	0.008
2001-005		0.5	43,600	160	0.007	0.007	32,700	110	0.005	0.005
20015-003	R0.075	0.3	43,600	250	0.015	0.02	32,700	190	0.012	0.016
20015-005		0.5	43,600	220	0.015	0.02	32,700	150	0.012	0.016
20015-010		1	43,600	160	0.007	0.01	32,700	120	0.006	0.008
2002-003	R0.1	0.3	43,600	550	0.025	0.05	32,700	380	0.02	0.04
2002-005		0.5	43,600	550	0.025	0.05	32,700	380	0.02	0.04
2002-010		1	43,600	440	0.02	0.04	32,700	270	0.015	0.03
2002-015		1.5	32,900	250	0.015	0.03	24,700	120	0.008	0.02
2003-006	R0.15	0.6	43,600	760	0.03	0.07	32,700	550	0.03	0.07
2003-010		1	43,600	760	0.03	0.07	32,700	550	0.03	0.07
2003-015		1.5	43,600	550	0.025	0.05	32,700	290	0.02	0.05
2003-020	R0.2	2	39,200	390	0.02	0.03	29,400	200	0.01	0.02
2004-010		1	43,600	1,090	0.05	0.1	32,700	760	0.04	0.08
2004-020		2	43,600	650	0.035	0.06	32,700	380	0.02	0.05
2004-030		3	35,000	470	0.02	0.04	29,200	230	0.01	0.03
2004-040	R0.25	4	27,300	270	0.008	0.015	19,600	110	0.005	0.01
2005-010		1	43,600	1,420	0.08	0.15	32,700	890	0.08	0.15
2005-020		2	43,600	870	0.08	0.15	32,700	550	0.08	0.15
2005-030		3	38,200	650	0.06	0.1	29,500	390	0.06	0.08
2005-040		4	32,700	440	0.04	0.08	24,000	220	0.025	0.05
2005-050	R0.3	5	27,300	330	0.02	0.04	19,600	160	0.01	0.02
2006-010		1	43,600	1,870	0.12	0.2	32,700	1,400	0.12	0.2
2006-020		2	43,600	1,750	0.12	0.2	32,700	1,310	0.12	0.2
2006-030		3	43,600	1,090	0.1	0.14	32,700	760	0.08	0.1
2006-040		4	32,700	760	0.07	0.1	27,300	440	0.04	0.06
2006-050		5	29,500	650	0.05	0.08	24,000	330	0.02	0.04
2006-060	R0.4	6	27,300	550	0.04	0.06	21,800	220	0.01	0.03
2008-020		2	43,600	2,820	0.15	0.3	32,700	1,980	0.15	0.3
2008-030		3	43,600	2,180	0.15	0.3	32,700	1,530	0.15	0.3
2008-040		4	38,200	1,750	0.12	0.2	29,500	1,090	0.1	0.16
2008-060	R0.5	6	32,700	1,090	0.08	0.15	21,800	550	0.05	0.1
2008-080		8	23,800	760	0.05	0.06	17,300	320	0.02	0.025
2010-020		2	39,100	2,740	0.25	0.4	30,000	2,050	0.25	0.4
2010-030		3	39,100	2,740	0.25	0.4	30,000	1,960	0.25	0.4
2010-040		4	39,100	2,350	0.2	0.4	29,500	1,560	0.2	0.4
2010-050	R0.5	5	38,200	2,180	0.16	0.3	29,500	1,530	0.12	0.25
2010-060		6	34,500	1,840	0.14	0.3	26,200	1,150	0.1	0.25
2010-080		8	27,300	1,090	0.12	0.2	19,600	550	0.06	0.1
2010-100		10	20,300	810	0.08	0.15	16,200	300	0.03	0.05
2010-120	12	13,100	490	0.06	0.1	9,800	160	0.015	0.04	

φ3mm Shank V Series

UDC-PCD Series

CBN Series

Square
Long Neck Square

Radius

Long Neck Radius
Taper Neck Radius

Ball / Long Shank Ball
Long Neck Ball
Taper Neck Ball

Taper

Barrel

Spiral V Cutter

Drill

Technical Data

Milling Conditions for DLCLB

WORK MATERIAL			COPPER / ALUMINUM ALLOYS				TUNGSTEN COPPER				
Model Number	Radius of Ball Nose (mm)	Effective Length (mm)	Spindle Speed (min ⁻¹)	Feed Rate (mm/min)	a_p Axial Depth (mm)	a_e Radial Depth (mm)	Spindle Speed (min ⁻¹)	Feed Rate (mm/min)	a_p Axial Depth (mm)	a_e Radial Depth (mm)	
2015-040	R0.75	4	25,500	2,270	0.3	0.6	21,300	1,700	0.3	0.6	
2015-060		6	25,500	2,040	0.3	0.6	21,300	1,530	0.3	0.6	
2015-120		12	17,500	1,090	0.15	0.3	13,100	550	0.1	0.2	
2015-180		18	8,500	590	0.08	0.12	6,800	170	0.02	0.06	
2020-040	R1	4	18,700	2,490	0.45	0.8	14,000	1,500	0.45	0.8	
2020-060		6	18,700	2,080	0.45	0.8	14,000	1,250	0.45	0.8	
2020-080		8	18,700	1,800	0.4	0.8	13,500	1,200	0.4	0.8	
2020-100		10	18,700	1,700	0.3	0.6	13,500	1,190	0.25	0.5	
2020-120		12	16,800	1,470	0.3	0.6	12,600	950	0.25	0.5	
2020-140		14	15,000	1,250	0.28	0.5	11,200	750	0.18	0.4	
2020-160		16	13,100	1,090	0.25	0.5	9,800	550	0.12	0.25	
2020-200		20	10,000	800	0.15	0.3	8,000	350	0.06	0.1	
2020-250		25	6,700	500	0.08	0.15	5,000	170	0.03	0.05	
2030-100		R1.5	10	15,000	2,550	0.6	1.2	12,000	1,800	0.6	1.2
2030-120			12	15,000	2,550	0.6	1.2	11,800	1,740	0.6	1.2
2030-140			14	15,000	2,510	0.6	1.2	11,700	1,670	0.6	1.2
2030-160	16		14,200	2,140	0.6	1	10,700	1,600	0.5	1	
2030-200	20		12,700	1,910	0.5	0.8	9,500	1,110	0.4	0.6	
2030-250	25		10,100	1,520	0.4	0.6	8,400	760	0.2	0.3	
2030-300	30		8,700	1,310	0.2	0.4	6,500	550	0.08	0.15	
2040-100	R2		10	11,500	2,880	0.8	1.6	8,600	2,010	0.8	1.6
2040-150		15	11,500	2,670	0.8	1.6	8,600	1,880	0.8	1.6	
2040-200		20	11,500	2,460	0.8	1.6	8,200	1,640	0.8	1.2	
2040-250		25	10,300	2,210	0.6	1.2	6,700	1,270	0.5	1	
2040-300		30	9,000	1,800	0.5	1	5,300	900	0.3	0.5	
2040-400		40	6,000	900	0.4	0.8	3,800	380	0.15	0.3	
2060-100	R3	10	10,000	4,190	1	2.2	7,500	3,150	1	2.2	
2060-150		15	10,000	4,190	1	2.2	7,500	2,800	1	2.2	
2060-200		20	10,000	3,000	1	2	7,500	2,000	0.7	1.5	
2060-300		30	10,000	3,000	0.8	1.6	7,000	1,800	0.4	0.8	

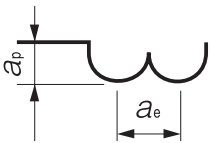

Note:

- Decrease the feed rate more than 50% from the milling parameters when slot milling.
- Decrease both spindle speed and feed rate proportionally when the milling parameters exceed the machine's maximum spindle speed, or when chattering occurs.
- Recommend wet coolant for Copper and Tungsten-Copper.

Ø3mm Shank
V Series

UDC-PCD
Series

CBN
Series

Square
Long Neck
Square

Radius
Long Neck
Radius

Taper Neck
Radius

Ball / Long
Shank Ball

Long Neck
Ball

Taper Neck
Ball

Taper

Barrel

Spiral
V Cutter

Drill

Technical Data

Milling Example of Copper Electrode Model
DLCLB R1 × EL16

Tough Pitch Copper C1100

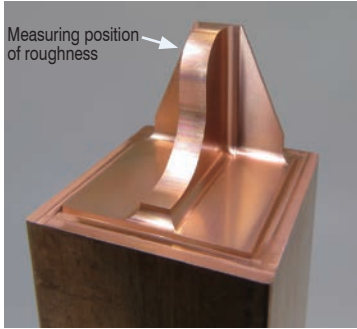

Model Size : 20 x 20 x Depth 16 mm
Coolant : Oil Mist

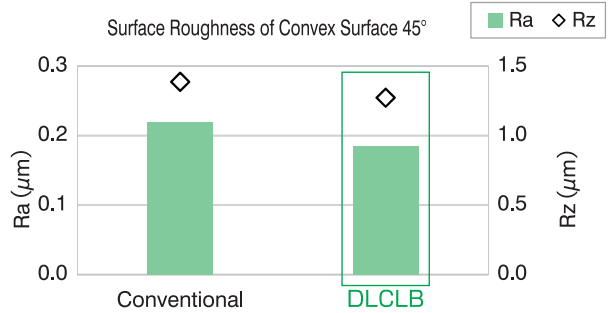

Improved surface roughness compared to the conventional model.

No	Milling Process	Milling Method	Spindle Speed (min ⁻¹)	Feed Rate (mm/min)	a _p (mm)	a _e (mm)	Overhang Length (mm)	Cycle Time (h:m:s)
1	Roughing	Contour Milling	10,800	1,090	0.25	0.5	24	1:31:59
2	Semi-finishing		10,800	1,090	0.05	0.05		1:31:15
3	Finishing		13,090	545	0.0001 (Cusp Height)	0.03		1:15:26
							Total	4:18:40

Conventional

DLCLB

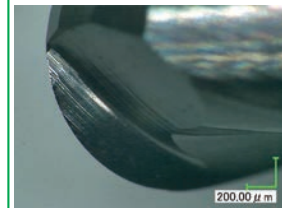
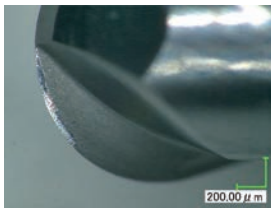

Tools after milling

DLCLB series Introduction Video



DLCLB series Housing-rib Electrode Milling Video



DLCLB has less wear and damage after 4 hours of milling, and enables stable milling throughout the long cycle time.

DLCLB Milling example

Copper Tungsten (Cu30 : W70)



Work Size : 50 x 50 x 50 mm
Coolant : Oil Mist

No	Milling Process	Tool	Spindle Speed (min ⁻¹)	Feed Rate (mm/min)	a_p (mm)	a_e (mm)	Allowance (mm)	Cycle Time (h:m:s)
1	Roughing —	R1.5 × EL10	12,000	1,800	0.6	1.2	0.1	0:19:07
2	Roughing —	R0.75 × EL6	21,300	1,530	0.3	0.6	0.1	0:21:34
3	Semi-finishing Flat surface	R1 × EL6	14,000	1,250	0.05	0.1	0.05	0:32:15
4	Semi-finishing Convex Pocket	R0.5 × EL5	29,500	1,530	0.05	0.06	0.05	1:43:09
5	Semi-finishing Corner	R0.4 × EL6	21,800	550	0.06	0.06	0.05	1:10:33
6	Finishing Flat surface	R1 × EL6	14,000	1,250	0.05	0.04	0	1:25:15
5	Finishing Convex Pocket	R0.5 × EL5	29,500	1,530	0.05	0.028	0	1:37:19
6	Finishing Cylinder corner	R0.3 × EL5	24,000	330	0.0002 (Cusp Height)	0.0002 (Cusp Height)	0	4:54:10

Total 12:03:22

DLC coating offers high wear resistance and is suited even for copper tungsten that is hard to mill.

DLCLB Milling example

Aluminum A7075



Work Size : 50 x 50 x 50 mm
Coolant : Water Soluble

Reflection of the background



The surface finish is of such high quality that the letters reflect perfectly in it.

Surface roughness

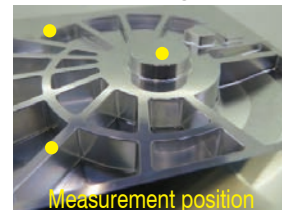

Average of 3 positions
Ra 0.03 μm

Suited even for Aluminum milling as the cutting edge is sharper than normal endmills for steels.

No	Milling Process	Tool	Spindle Speed (min ⁻¹)	Feed Rate (mm/min)	a_p (mm)	a_e (mm)	Allowance (mm)	Cycle Time (h:m:s)
1	Roughing —	R1.5 × EL10	15,000	2,550	0.6	1.2	0.1	0:17:49
2	Roughing —	R0.75 × EL6	25,500	2,040	0.3	0.6	0.1	0:20:22
3	Semi-finishing Flat surface	R1 × EL6	18,700	2,100	0.05	0.1	0.05	0:25:06
4	Semi-finishing Convex Pocket	R0.5 × EL5	30,000	1,700	0.05	0.06	0.05	0:53:17
5	Semi-finishing Corner	R0.4 × EL6	30,000	1,000	0.06	0.06	0.05	0:17:02
6	Finishing Flat surface	R1 × EL6	18,700	2,100	0.05	0.04	0	1:06:03
5	Finishing Convex Pocket	R0.5 × EL5	30,000	1,700	0.05	0.028	0	1:31:32
6	Finishing Cylinder corner	R0.3 × EL5	30,000	650	0.0002 (Cusp Height)	0.0002 (Cusp Height)	0	2:40:18

Total 7:31:29

Ø3mm Shank
V Series

UDC-PCD
Series

CBN
Series

Square

Long Neck
Square

Radius

Long Neck
Radius

Taper Neck
Radius

Ball / Long
Shank Ball

Long Neck
Ball

Taper Neck
Ball

Taper

Barrel

Spiral
V Cutter

Drill

Technical Data



Size R0.2~R3

CPRB



Material Applications (★ Highly Recommended ● Recommended ○ Suggested)

Work Material																	
Carbon Steels S45C S55C	Alloy Steels SK / SCM SUS	Prehardened Steels NAK HPM	Hardened Steels					Cast Iron	Aluminum Alloys	Graphite	Copper	Plastics	Glass Filled Plastics	Titanium Alloys	Heat Resistant Alloys	Cemented Carbide	Hard Brittle (Non-Metallic) Materials
			~50HRC	~55HRC	~60HRC	~65HRC	~70HRC										
								○			●	★					

Features

Long neck ball design for milling Plastics.
Designed especially for deep rib milling using an undercut form.

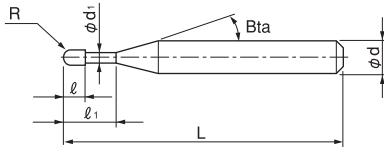

The shank taper angle shown is not an exact value and to avoid contact with the work piece, we recommend the user controls the precise value of this angle. Shank taper angle should not make contact with the work piece.

Total 80 models

Unit (mm)

Model Number	Radius of Ball Nose R	Effective Length ℓ_1	Length of Cut ℓ	Neck Diameter ϕd_1	Shank Taper Angle Bta	Overall Length L	Shank Diameter ϕd	Suggested Retail Price ¥
CPRB 2004-1	R0.2	1	0.4	0.36	11°	45	4	8,000
CPRB 2004-2		2				45		8,800
CPRB 2004-3		3				45		9,800
CPRB 2005-2	R0.25	2	0.8	0.46	11°	45	4	8,000
CPRB 2005-4		4				45		8,000
CPRB 2005-6		6				45		8,800
CPRB 2005-8		8				45		8,800
CPRB 2005-10		10				50		9,500
CPRB 2006-2	R0.3	2	1	0.56	11°	45	4	7,200
CPRB 2006-4		4				45		7,200
CPRB 2006-6		6				45		7,200
CPRB 2006-8		8				45		7,200
CPRB 2008-2		2				1.1		0.76
CPRB 2008-4	4	45	7,080					
CPRB 2008-6	6	45	7,080					
CPRB 2008-8	8	45	7,080					
CPRB 2008-10	10	50	7,080					

Unit (mm)

Model Number	Radius of Ball Nose R	Effective Length ℓ_1	Length of Cut ℓ	Neck Diameter ϕd_1	Shank Taper Angle β	Overall Length L	Shank Diameter ϕd	Suggested Retail Price ¥
CPRB 2010-3	R0.5	3	1.2	0.93	11°	45	4	6,120
CPRB 2010-4		4				45	4	6,120
CPRB 2010-6		6				45	4	6,120
CPRB 2010-8		8				45	4	6,120
CPRB 2010-10		10				45	4	6,120
CPRB 2010-12		12				45	4	6,120
CPRB 2010-14		14				50	4	6,120
CPRB 2010-16		16				50	4	6,120
CPRB 2010-20		20				55	4	7,200
CPRB 2012-8		R0.6				8	1.3	1.13
CPRB 2012-12	12		45	4	8,000			
CPRB 2014-8	R0.7	8	1.4	1.33	11°	45	4	8,000
CPRB 2014-12		12				45	4	8,000
CPRB 2014-16		16				50	4	8,000
CPRB 2015-6	R0.75	6	1.45	1.43	11°	45	4	6,240
CPRB 2015-8		8				45	4	6,240
CPRB 2015-10		10				45	4	6,240
CPRB 2015-12		12				45	4	6,240
CPRB 2015-16		16				50	4	6,240
CPRB 2015-20		20				55	4	6,240
CPRB 2016-8	R0.8	8	1.5	1.5	11°	45	4	8,000
CPRB 2016-12		12				45	4	8,000
CPRB 2016-16		16				50	4	8,000
CPRB 2016-20		20				55	4	8,000
CPRB 2018-8	R0.9	8	1.6	1.7	11°	45	4	8,000
CPRB 2018-12		12				45	4	8,000
CPRB 2018-16		16				50	4	8,000
CPRB 2018-20		20				55	4	8,000
CPRB 2020-4	R1	4	1.7	1.9	11°	45	4	6,120
CPRB 2020-6		6				45	4	6,120
CPRB 2020-8		8				45	4	6,120
CPRB 2020-10		10				45	4	6,120
CPRB 2020-12		12				45	4	6,120
CPRB 2020-14		14				50	4	6,120
CPRB 2020-16		16				50	4	6,120
CPRB 2020-20		20				55	4	6,120
CPRB 2020-22		22				60	4	6,120
CPRB 2020-25		25				65	4	6,120
CPRB 2020-30		30				70	4	7,440

3mm Shank
V Series

UDC-PCD
Series

CBN
Series

Square
Long Neck
Square

Radius
Long Neck
Radius

Taper Neck
Radius

Ball / Long
Shank Ball

Long Neck
Ball
Taper Neck
Ball

Taper

Barrel

Spiral
V Cutter

Drill

Technical Data

Unit (mm)

Model Number	Radius of Ball Nose R	Effective Length l_1	Length of Cut l	Neck Diameter ϕd_1	Shank Taper Angle Bta	Overall Length L	Shank Diameter ϕd	Suggested Retail Price ¥
CPRB 2030-8	R1.5	8	2.5	2.9	11°	60	6	8,640
CPRB 2030-10		10				60	6	8,640
CPRB 2030-12		12				60	6	8,640
CPRB 2030-16		16				60	6	8,640
CPRB 2030-20		20				70	6	8,640
CPRB 2030-25		25				70	6	8,640
CPRB 2030-30		30				70	6	8,640
CPRB 2030-35		35				80	6	10,080
CPRB 2040-10	R2	10	3	3.8	11°	70	6	8,640
CPRB 2040-12		12				70	6	8,640
CPRB 2040-16		16				70	6	8,640
CPRB 2040-20		20				70	6	8,640
CPRB 2040-25		25				70	6	8,640
CPRB 2040-30		30				70	6	8,640
CPRB 2040-35		35				80	6	8,880
CPRB 2040-40		40				90	6	9,120
CPRB 2040-45		45				90	6	10,320
CPRB 2040-50		50				100	6	11,280
CPRB 2050-20	R2.5	20	3.5	4.8	11°	70	6	12,080
CPRB 2050-25		25				70	6	12,080
CPRB 2050-30		30				80	6	13,130
CPRB 2050-35		35				80	6	13,130
CPRB 2060-30	R3	30	6	5.8	—	80	6	10,080
CPRB 2060-50		50			—	120	6	12,180

φ3mm Shank V Series

UDC-PCD Series

CBN Series

Square
Long Neck Square

Radius

Long Neck Radius
Taper Neck Radius

Ball / Long Shank Ball

Long Neck Ball
Taper Neck Ball

Taper

Barrel

Spiral V Cutter

Drill

Technical Data

Milling Conditions for CPRB

WORK MATERIAL		ALUMINUM ALLOYS			PLASTICS		
Model Number	Radius of Ball Nose (mm)	Spindle Speed (min ⁻¹)	Feed Rate (mm/min)	Axial Depth a_p (mm)	Spindle Speed (min ⁻¹)	Feed Rate (mm/min)	Axial Depth a_p (mm)
2004	R0.2	35,000	560	0.005~0.01	35,000	1,100	0.07~0.2
2005	R0.25	35,000	700	0.003~0.01	28,000	1,200	0.08~0.25
2006	R0.3	35,000	910	0.006~0.03	24,000	1,200	0.1 ~0.3
2008	R0.4	26,000	940	0.006~0.05	18,000	900	0.13~0.4
2010	R0.5	21,000	970	0.005~0.08	14,000	700	0.17~0.5
2012	R0.6	18,000	1,010	0.04 ~0.09	12,000	600	0.2 ~0.6
2014	R0.7	15,000	1,020	0.05 ~0.1	10,000	500	0.23~0.7
2015	R0.75	14,000	1,010	0.06 ~0.12	9,500	480	0.25~0.75
2016	R0.8	13,000	1,010	0.08 ~0.13	9,000	450	0.27~0.8
2018	R0.9	12,000	1,060	0.09 ~0.15	8,000	400	0.3 ~0.9
2020	R1	11,000	1,100	0.03 ~0.21	7,000	350	0.33~1
2030	R1.5	6,900	760	0.03 ~0.23	4,800	240	0.5 ~1.5
2040	R2	5,200	690	0.01 ~0.28	3,600	180	0.6 ~2
2050	R2.5	4,200	590	0.16 ~0.31	2,900	150	0.8 ~2.5
2060	R3	3,500	550	0.22 ~0.36	2,400	120	1 ~3

Slotting

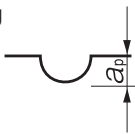

Note:

- Adjust the axial depth (a_p) based on the effective length and milling condition.
- Recommend water soluble coolant for Aluminum Alloys and Copper.
- Recommend air blow for Plastics.
- Remove chips from the work piece to keep the milling surface quality.
- If chips clog on the tool, stop the operation and remove them accordingly.

Ø3mm Shank
V SeriesUDC-PCD
SeriesCBN
Series

Square

Long Neck
Square

Radius

Long Neck
RadiusTaper Neck
RadiusBall / Long
Shank BallLong Neck
BallTaper Neck
Ball

Taper

Barrel

Spiral
V Cutter

Drill

Technical Data



Size R0.3~R3

CFLB



R0.3~R1.5

R2~R3

R2~R3

Material Applications (★ Highly Recommended ● Recommended ○ Suggested)

Work Material																	
Carbon Steels S45C S55C	Alloy Steels SK / SCM SUS	Prehardened Steels NAK HPM	Hardened Steels					Cast Iron	Aluminum Alloys	Graphite	Copper	Plastics	Glass Filled Plastics	Titanium Alloys	Heat Resistant Alloys	Cemented Carbide	Hard Brittle (Non-Metallic) Materials
			~50HRC	~55HRC	~60HRC	~65HRC	~70HRC										
●	●	●	●	●				○	●		○		●	●			

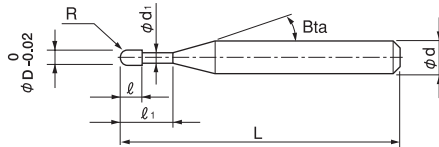

The shank taper angle shown is not an exact value and to avoid contact with the work piece, we recommend the user controls the precise value of this angle. Shank taper angle should not make contact with the work piece.

Features

Suited for various heat-resistant alloys including Titanium and Inconel due to large pocket, variable pitch and high lubricity coating.
Tip slot design offers clean milling surfaces even for Copper, Aluminum and Acrylic.



Copper C1100



Acrylic



Aluminum A7075

3 series of tip slot ball

Raw materials 40 50 55 60 65 Hardness (HRC)



CFB 3 flute ball, Flute design: Positive
CFLB 3 flute long neck ball

HFB 4 flute ball, Flute design: Negative



3 flute ball CFB series (P442) and 4 flute ball HFB series for hard materials (P452) are also available.



Total 47 models

Unit (mm)

Model Number	Radius of Ball Nose R	Effective Length l_1	Length of Cut l	Neck Diameter ϕd	Shank Taper Angle β	Overall Length L	Shank Diameter ϕd	Suggested Retail Price ¥	Effective Length by Inclined Angles				
									30°	1°	1°30'	2°	3°
CFLB 3006-020	R0.3	2	0.48	0.58	16°	50	4	6,970	2.16	2.23	2.30	2.37	2.53
CFLB 3006-030		3				50	4	7,130	3.20	3.30	3.40	3.51	3.76
CFLB 3006-040		4				50	4	7,380	4.23	4.36	4.50	4.65	4.98
CFLB 3006-060		6				50	4	7,380	6.30	6.49	6.70	6.93	7.43
CFLB 3008-040	R0.4	4	0.64	0.78	16°	50	4	7,380	4.23	4.36	4.49	4.64	4.96
CFLB 3008-060		6				50	4	7,380	6.29	6.49	6.69	6.91	7.41
CFLB 3008-080		8				50	4	7,380	8.36	8.62	8.89	9.19	9.85
CFLB 3010-025	R0.5	2.5	0.8	0.96	16°	50	4	6,310	2.71	2.79	2.87	2.95	3.14
CFLB 3010-030		3				50	4	6,310	3.23	3.32	3.42	3.52	3.75
CFLB 3010-040		4				50	4	6,560	4.26	4.38	4.52	4.66	4.98
CFLB 3010-050		5				50	4	6,560	5.29	5.45	5.62	5.80	6.20
CFLB 3010-060		6				50	4	6,970	6.32	6.51	6.72	6.94	7.42
CFLB 3010-080		8				50	4	6,970	8.39	8.64	8.92	9.21	9.87
CFLB 3010-100		10				50	4	6,970	10.45	10.77	11.12	11.49	12.32
CFLB 3010-120		12				50	4	6,970	12.51	12.90	13.32	13.77	14.76
CFLB 3015-040	R0.75	4	1.2	1.43	16°	50	4	6,970	4.18	4.29	4.41	4.54	4.83
CFLB 3015-060		6				50	4	6,970	6.24	6.42	6.61	6.82	7.28
CFLB 3015-080		8				50	4	7,220	8.30	8.55	8.82	9.10	9.73
CFLB 3015-100		10				50	4	7,380	10.37	10.68	11.02	11.38	12.18
CFLB 3015-120		12				50	4	7,950	12.43	12.81	13.22	13.65	14.62
CFLB 3015-160		16				50	4	7,950	16.56	17.07	17.62	18.21	19.52
CFLB 3020-040	R1	4	1.6	1.83	16°	50	4	6,300	4.35	4.46	4.58	4.71	4.99
CFLB 3020-060		6				50	4	6,810	6.41	6.59	6.78	6.99	7.44
CFLB 3020-080		8				50	4	6,970	8.48	8.72	8.98	9.26	9.89
CFLB 3020-100		10				50	4	6,970	10.54	10.85	11.18	11.54	12.33
CFLB 3020-120		12				50	4	7,220	12.60	12.98	13.38	13.82	14.78
CFLB 3020-140		14				50	4	7,220	14.66	15.11	15.59	16.09	17.23
CFLB 3020-160		16				50	4	7,220	16.73	17.24	17.79	18.37	19.68
CFLB 3020-180		18				55	4	7,220	18.79	19.37	19.99	20.65	No Interference
CFLB 3020-200		20				55	4	7,220	20.85	21.50	22.19	22.93	No Interference
CFLB 3030-080		R1.5				8	2.4	2.73	16°	60	6	6,970	8.64
CFLB 3030-100	10		60	6	7,630	10.70				11.00	11.33	11.67	12.44
CFLB 3030-120	12		60	6	7,630	12.77				13.14	13.53	13.96	14.89
CFLB 3030-160	16		60	6	7,950	16.89				17.39	17.93	18.50	19.78
CFLB 3030-200	20		70	6	8,040	21.02				21.65	22.33	23.06	24.68
CFLB 3030-250	25		70	6	8,040	26.17				26.98	27.83	28.75	No Interference
CFLB 3040-100	R2	10	3.2	3.63	16°	70	6	7,200	10.87	11.16	11.47	11.80	12.54
CFLB 3040-120		12				70	6	7,380	12.93	13.29	13.67	14.08	14.99
CFLB 3040-160		16				70	6	7,710	17.06	17.55	18.07	18.63	19.89
CFLB 3040-200		20				70	6	8,200	21.18	21.81	22.47	23.19	No Interference
CFLB 3040-250		25				70	6	8,200	26.34	27.13	27.98	28.88	No Interference
CFLB 3040-300		30				70	6	8,200	31.50	32.45	33.48	No Interference	No Interference
CFLB 3060-200	R3	20	4.8	5.42	—	80	6	9,840	No Interference	No Interference	No Interference	No Interference	No Interference
CFLB 3060-250		25				80	6	9,840	No Interference	No Interference	No Interference	No Interference	No Interference
CFLB 3060-300		30				80	6	10,090	No Interference	No Interference	No Interference	No Interference	No Interference
CFLB 3060-350		35				80	6	10,500	No Interference	No Interference	No Interference	No Interference	No Interference
CFLB 3060-400		40				90	6	11,070	No Interference	No Interference	No Interference	No Interference	No Interference

- 3 Flutes
- Ø3mm Shank V Series
- UDC-PCD Series
- CBN Series
- Square
- Long Neck Square
- Radius
- Long Neck Radius
- Taper Neck Radius
- Ball / Long Shank Ball
- Long Neck Ball
- Taper Neck Ball
- Taper
- Barrel
- Spiral V Cutter
- Drill
- Technical Data

Milling Conditions for CFLB

WORK MATERIAL			COPPER ALUMINUM ALLOYS C1100 / A5052 / A7075 etc.				CARBON STEELS / ALLOY STEELS / HARDENED STEELS S50C / NAK80 etc. (~45HRC)				HARDENED STEELS STAVAX / SKD61 etc. (~55HRC)				
Coolant			WET				WET / DRY				WET / DRY				
Model Number	Outside Diameter (mm)	Effective Length (mm)	Spindle Speed (min ⁻¹)	Feed Rate (mm/min)	a _p Axial Depth (mm)	a _e Radial Depth (mm)	Spindle Speed (min ⁻¹)	Feed Rate (mm/min)	a _p Axial Depth (mm)	a _e Radial Depth (mm)	Spindle Speed (min ⁻¹)	Feed Rate (mm/min)	a _p Axial Depth (mm)	a _e Radial Depth (mm)	
φ3mm Shank V Series UDC-PCD Series CBN Series Square Long Neck Square Radius Long Neck Radius Taper Neck Radius Ball / Long Shank Ball Long Neck Ball Taper Neck Ball Taper Barrel Spiral V Cutter Drill Technical Data	R0.3	3006-020	2	30,000	1,000	0.03	0.13	30,000	1,000	0.03	0.13	30,000	700	0.03	0.13
		3006-030	3	30,000	1,000	0.03	0.13	30,000	1,000	0.03	0.13	30,000	700	0.03	0.13
		3006-040	4	30,000	700	0.02	0.1	30,000	700	0.02	0.1	30,000	480	0.02	0.1
		3006-060	6	30,000	475	0.01	0.05	30,000	475	0.01	0.05	30,000	300	0.01	0.05
R0.4	3008-040	4	30,000	1,250	0.04	0.17	30,000	1,250	0.04	0.17	30,000	850	0.04	0.17	
	3008-060	6	30,000	1,000	0.03	0.14	30,000	1,000	0.03	0.14	30,000	680	0.03	0.14	
	3008-080	8	27,000	770	0.018	0.12	27,000	770	0.018	0.12	27,000	510	0.018	0.12	
	3010-025	2.5	30,000	1,500	0.05	0.21	30,000	1,500	0.05	0.21	30,000	1,000	0.05	0.21	
R0.5	3010-030	3	30,000	1,500	0.05	0.21	30,000	1,500	0.05	0.21	30,000	1,000	0.05	0.21	
	3010-040	4	30,000	1,500	0.05	0.21	30,000	1,500	0.05	0.21	30,000	1,000	0.05	0.21	
	3010-050	5	30,000	1,500	0.05	0.21	30,000	1,500	0.05	0.21	30,000	1,000	0.05	0.21	
	3010-060	6	30,000	1,500	0.04	0.19	30,000	1,500	0.04	0.19	30,000	1,000	0.04	0.19	
	3010-080	8	25,200	1,200	0.03	0.17	25,200	1,200	0.03	0.17	25,200	800	0.03	0.17	
	3010-100	10	24,100	930	0.023	0.15	24,100	930	0.023	0.15	24,100	620	0.023	0.155	
R0.75	3010-120	12	23,000	660	0.017	0.135	23,000	660	0.017	0.135	23,000	440	0.017	0.135	
	3015-040	4	30,000	2,500	0.075	0.32	30,000	2,500	0.075	0.32	30,000	1,700	0.075	0.32	
	3015-060	6	30,000	2,500	0.075	0.32	30,000	2,500	0.075	0.32	30,000	1,700	0.075	0.32	
	3015-080	8	30,000	2,500	0.075	0.32	30,000	2,500	0.075	0.32	30,000	1,700	0.075	0.32	
	3015-100	10	24,000	2,000	0.05	0.26	24,000	2,000	0.05	0.26	24,000	1,350	0.05	0.26	
	3015-120	12	20,800	1,400	0.035	0.25	20,800	1,400	0.035	0.25	20,800	925	0.035	0.23	
R1	3015-160	16	17,500	800	0.025	0.24	17,500	800	0.025	0.24	17,500	500	0.017	0.2	
	3020-040	4	30,000	3,200	0.2	0.6	30,000	3,200	0.2	0.6	30,000	2,500	0.2	0.6	
	3020-060	6	30,000	3,200	0.2	0.6	30,000	3,200	0.2	0.6	30,000	2,500	0.2	0.6	
	3020-080	8	30,000	3,200	0.2	0.6	30,000	3,200	0.2	0.6	29,150	2,400	0.2	0.6	
	3020-100	10	27,000	3,000	0.2	0.6	27,000	3,000	0.2	0.6	24,300	2,000	0.2	0.6	
	3020-120	12	21,600	2,400	0.15	0.5	21,600	2,400	0.15	0.5	21,000	1,600	0.14	0.5	
	3020-140	14	16,200	1,600	0.12	0.45	16,200	1,600	0.12	0.45	16,200	1,200	0.08	0.35	
	3020-160	16	12,600	1,200	0.1	0.4	12,600	1,200	0.1	0.4	12,600	1,200	0.05	0.3	
	3020-180	18	12,350	1,060	0.07	0.375	12,350	1,060	0.07	0.375	12,350	900	0.035	0.285	
	3020-200	20	12,050	930	0.04	0.35	12,050	930	0.04	0.35	12,050	600	0.017	0.27	
R1.5	3030-080	8	24,000	4,000	0.3	0.9	24,000	4,000	0.3	0.9	21,600	2,700	0.3	0.9	
	3030-100	10	24,000	4,000	0.3	0.9	24,000	4,000	0.3	0.9	21,600	2,700	0.3	0.9	
	3030-120	12	24,000	3,600	0.3	0.9	24,000	3,600	0.3	0.9	21,600	2,450	0.3	0.9	
	3030-160	16	16,800	2,800	0.27	0.85	16,800	2,800	0.27	0.85	15,100	1,900	0.27	0.85	
	3030-200	20	12,000	2,000	0.24	0.75	12,000	2,000	0.24	0.75	10,800	1,350	0.24	0.75	
	3030-250	25	8,400	1,200	0.15	0.65	8,400	1,200	0.15	0.65	7,500	800	0.15	0.65	

Milling Conditions for CFLB

3 Flutes

WORK MATERIAL			TITANIUM ALLOYS STAINLESS STEELS Ti-6Al-4V / SUS etc.				HEAT RESISTANT ALLOYS Inconel718			
Coolant			WET				WET			
Model Number	Outside Diameter (mm)	Effective Length (mm)	Spindle Speed (min ⁻¹)	Feed Rate (mm/min)	a _p Axial Depth (mm)	a _e Radial Depth (mm)	Spindle Speed (min ⁻¹)	Feed Rate (mm/min)	a _p Axial Depth (mm)	a _e Radial Depth (mm)
3006-020	R0.3	2	20,000	1,000	0.015	0.09	9,000	225	0.015	0.09
3006-030		3	20,000	1,000	0.015	0.09	7,500	185	0.012	0.08
3006-040		4	20,000	700	0.01	0.07	4,500	100	0.01	0.07
3006-060		6	20,000	200	0.005	0.035	2,400	30	0.004	0.035
3008-040	R0.4	4	20,000	1,250	0.02	0.12	10,000	310	0.02	0.12
3008-060		6	20,000	950	0.013	0.075	7,200	200	0.013	0.075
3008-080		8	18,000	600	0.007	0.06	4,450	95	0.007	0.06
3010-025	R0.5	2.5	20,000	1,500	0.025	0.15	10,000	375	0.025	0.15
3010-030		3	20,000	1,500	0.025	0.15	10,000	375	0.025	0.15
3010-040		4	20,000	1,500	0.025	0.15	9,000	330	0.025	0.15
3010-050		5	20,000	1,500	0.025	0.15	7,500	280	0.02	0.14
3010-060		6	20,000	1,500	0.02	0.14	6,000	220	0.02	0.13
3010-080		8	16,800	1,200	0.015	0.12	3,500	110	0.015	0.11
3010-100		10	16,050	930	0.011	0.1	3,350	85	0.011	0.095
3010-120	12	15,300	660	0.008	0.095	3,200	60	0.008	0.085	
3015-040	R0.75	4	20,000	2,500	0.035	0.22	9,000	380	0.03	0.22
3015-060		6	20,000	2,500	0.035	0.22	9,000	380	0.03	0.22
3015-080		8	20,000	2,500	0.035	0.22	6,000	250	0.025	0.18
3015-100		10	16,000	2,000	0.025	0.19	4,500	170	0.02	0.17
3015-120		12	14,000	1,370	0.02	0.18	4,100	135	0.017	0.17
3015-160		16	12,000	730	0.013	0.17	3,600	100	0.013	0.165
3020-040	R1	4	20,000	3,200	0.1	0.43	12,000	1,000	0.1	0.4
3020-060		6	20,000	3,200	0.1	0.43	12,000	1,000	0.1	0.4
3020-080		8	20,000	3,200	0.1	0.43	10,800	900	0.1	0.4
3020-100		10	18,000	3,000	0.1	0.43	9,000	750	0.08	0.36
3020-120		12	14,400	2,400	0.075	0.38	7,200	600	0.08	0.34
3020-140		14	10,800	1,600	0.06	0.34	5,400	400	0.07	0.32
3020-160		16	8,400	1,200	0.05	0.34	4,200	300	0.06	0.3
3020-180		18	8,250	1,000	0.035	0.26	4,100	250	0.035	0.26
3020-200		20	8,050	800	0.017	0.245	4,000	200	0.015	0.23
3030-080	R1.5	8	16,000	4,000	0.15	0.65	8,000	1,000	0.15	0.65
3030-100		10	16,000	4,000	0.15	0.65	7,200	900	0.15	0.65
3030-120		12	16,000	3,600	0.15	0.65	7,200	800	0.15	0.65
3030-160		16	11,200	2,800	0.135	0.62	4,800	600	0.12	0.55
3030-200		20	8,000	2,000	0.12	0.58	3,600	400	0.1	0.52
3030-250		25	5,600	1,200	0.075	0.46	2,800	300	0.09	0.48

- Ø3mm Shank V Series
- UDC-PCD Series
- CBN Series
- Square
- Long Neck Square
- Radius
- Long Neck Radius
- Taper Neck Radius
- Ball / Long Shank Ball
- Long Neck Ball
- Taper Neck Ball
- Taper
- Barrel
- Spiral V Cutter
- Drill
- Technical Data

Milling Conditions for CFLB

WORK MATERIAL			COPPER ALUMINUM ALLOYS C1100 / A5052 / A7075 etc.				CARBON STEELS / ALLOY STEELS / HARDENED STEELS S50C / NAK80 etc (~45HRC)				HARDENED STEELS STAVAX / SKD61 etc. (~55HRC)			
Coolant			WET				WET / DRY				WET / DRY			
Model Number	Outside Diameter (mm)	Effective Length (mm)	Spindle Speed (min ⁻¹)	Feed Rate (mm/min)	a _p Axial Depth (mm)	a _e Radial Depth (mm)	Spindle Speed (min ⁻¹)	Feed Rate (mm/min)	a _p Axial Depth (mm)	a _e Radial Depth (mm)	Spindle Speed (min ⁻¹)	Feed Rate (mm/min)	a _p Axial Depth (mm)	a _e Radial Depth (mm)
3040-100	R2	10	18,000	4,000	0.4	1.2	18,000	4,000	0.4	1.2	16,200	2,700	0.4	1.2
		12	18,000	4,000	0.4	1.2	18,000	4,000	0.4	1.2	16,200	2,700	0.4	1.2
		16	16,200	3,600	0.4	1.2	16,200	3,600	0.4	1.2	14,600	2,450	0.4	1.2
		20	13,500	3,000	0.4	1.2	13,500	3,000	0.4	1.2	12,200	2,000	0.4	1.2
		25	9,900	2,200	0.32	1.05	9,900	2,200	0.32	1.05	8,900	1,450	0.32	1.05
		30	7,200	1,400	0.2	0.85	7,200	1,400	0.2	0.85	6,500	950	0.2	0.85
3060-200	R3	20	12,000	4,000	0.6	1.8	12,000	4,000	0.6	1.8	10,800	2,700	0.6	1.8
		25	10,500	3,500	0.6	1.8	10,500	3,500	0.6	1.8	9,450	2,350	0.6	1.8
		30	9,000	3,000	0.6	1.8	9,000	3,000	0.6	1.8	8,100	2,000	0.6	1.8
		35	7,500	2,500	0.6	1.8	7,500	2,500	0.5	1.6	6,750	1,650	0.5	1.6
		40	6,000	2,000	0.4	1.4	6,000	2,000	0.4	1.4	5,400	1,350	0.4	1.4

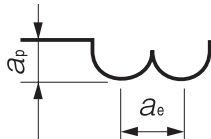

Note:

- Decrease the feed rate more than 50% from the milling parameters when slot milling.
- Decrease both spindle speed and feed rate proportionally when the milling parameters exceed the machines maximum speed, or when the tool is chattering and heats up to a red color.
- Recommend wet coolant for Copper.
- DRY: air blow, WET: water soluble or oil coolant.

Milling Conditions for CFLB

WORK MATERIAL			TITANIUM ALLOYS STAINLESS STEELS Ti-6Al-4V / SUS etc.				HEAT RESISTANT ALLOYS Inconel718			
Coolant			WET				WET			
Model Number	Outside Diameter (mm)	Effective Length (mm)	Spindle Speed (min ⁻¹)	Feed Rate (mm/min)	a_p Axial Depth (mm)	a_e Radial Depth (mm)	Spindle Speed (min ⁻¹)	Feed Rate (mm/min)	a_p Axial Depth (mm)	a_e Radial Depth (mm)
3040-100	R2	10	12,000	4,000	0.2	0.87	6,000	1,000	0.2	0.85
3040-120		12	12,000	4,000	0.2	0.87	6,000	1,000	0.2	0.85
3040-160		16	10,800	3,600	0.2	0.87	5,400	900	0.2	0.85
3040-200		20	9,000	3,000	0.2	0.87	4,500	750	0.17	0.76
3040-250		25	6,600	2,200	0.16	0.78	2,700	400	0.14	0.68
3040-300		30	4,800	1,400	0.1	0.62	2,100	300	0.12	0.63
3060-200	R3	20	8,000	4,000	0.3	1.3	3,600	900	0.3	1.3
3060-250		25	7,000	3,500	0.3	1.3	3,300	820	0.27	1.2
3060-300		30	6,000	3,000	0.3	1.3	3,000	750	0.25	1.17
3060-350		35	5,000	2,500	0.25	1.15	2,400	570	0.23	1.1
3060-400		40	4,000	2,000	0.2	1.05	1,800	400	0.21	1.04

Tool Life Comparison with Conventional Model (2 flutes) R0.3 x EL3 mm S50C

S50C Pocket Milling

■ Milling Conditions

Spindle Speed	30,000 min ⁻¹
Feed Rate	1,000 mm/min
a_p	0.03 mm
a_e	0.13 mm
Coolant	Air Blow (Through Spindle)
Overhang Length	12 mm
Pocket Size	$\phi 5 \times 3$ mm
Cycle Time	14 min/pocket

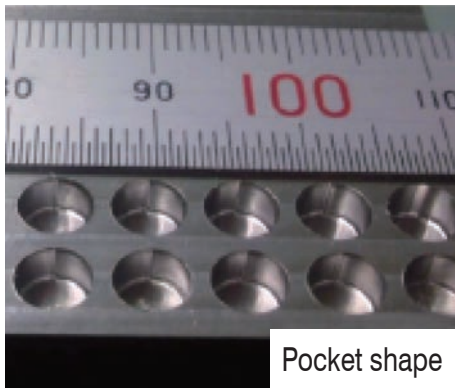
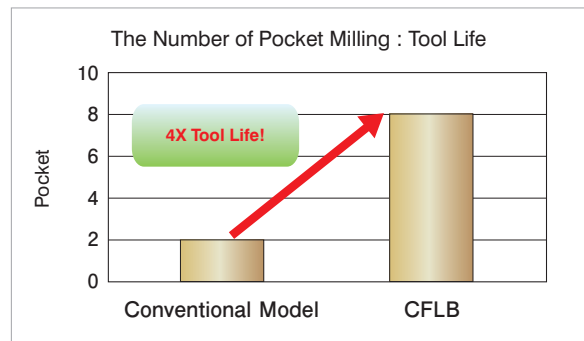
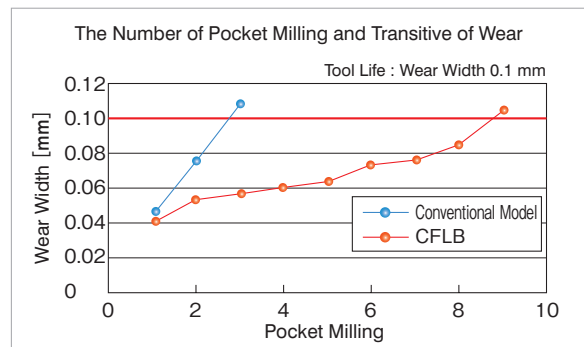

$\phi 3$ mm Shank
V Series

UDC-PCD
Series

CBN
Series

Square

Long Neck
Square

Radius

Long Neck
Radius

Taper Neck
Radius

Ball / Long
Shank Ball

Long Neck
Ball

Taper Neck
Ball

Taper

Barrel

Spiral
V Cutter

Drill

Technical Data



Size R0.1~R2

HTNB



Material Applications (★ Highly Recommended ● Recommended ○ Suggested)

Work Material																	
Carbon Steels S45C S55C	Alloy Steels SK / SCM SUS	Prehardened Steels NAK HPM	Hardened Steels					Cast Iron	Aluminum Alloys	Graphite	Copper	Plastics	Glass Filled Plastics	Titanium Alloys	Heat Resistant Alloys	Cemented Carbide	Hard Brittle (Non-Metallic) Materials
			~50HRC	~55HRC	~60HRC	~65HRC	~70HRC										
○	○	●	●	●	●	●		○			●			○	○		

Total 245 models

Model Number	Radius of Ball Nose R	Neck Taper Angle TN	Neck Length ℓ_2	Effective Length ℓ_1	Length of Cut ℓ	Neck Diameter ϕd_1	Shank Taper Angle Bta	Overall Length L	Shank Diameter ϕd	Shape	Suggested Retail Price ¥
HTNB 2002-015-1	R0.1	30°	1.5	—	0.16	—	16°	50	4	A	11,520
HTNB 2002-020-1			2					50	4		12,120
HTNB 2002-030-1			3					50	4		14,400
HTNB 2002-015-2		1°	1.5					50	4		11,520
HTNB 2002-020-2			2					50	4		12,120
HTNB 2002-030-2			3					50	4		14,400
HTNB 2002-015-3		1°30'	1.5					50	4		11,520
HTNB 2002-020-3			2					50	4		12,120
HTNB 2002-030-3			3					50	4		14,400
HTNB 2003-020-1		R0.15	30°					2	—		0.24
HTNB 2003-030-1	3			50	4	12,120					
HTNB 2003-020-2	1°			2	50	4	11,520				
HTNB 2003-030-2			3	50	4	12,120					
HTNB 2003-020-3			1°30'	2	50	4	11,520				
HTNB 2003-030-3	3			50	4	12,120					
HTNB 2004-030-1	R0.2	30°		3	—	0.32	—	16°	50	4	A
HTNB 2004-040-1			4	50					4	8,880	
HTNB 2004-060-1			6	50					4	9,600	
HTNB 2004-030-2		1°	3	50					4	8,880	
HTNB 2004-040-2			4	50					4	8,880	
HTNB 2004-060-2			6	50					4	9,600	
HTNB 2004-030-3		1°30'	3	50					4	8,880	
HTNB 2004-040-3			4	50					4	8,880	
HTNB 2004-060-3			6	50					4	9,600	

Features

Taper Neck design offers high rigidity.
 Stable milling and excellent surface even on deep milling.
 HARDMAX coat offers heat resistance, toughness and lubricity at a high level.
 Suitable for hard materials up to 65HRC.

The shank taper angle shown is not an exact value and to avoid contact with the work piece, we recommend the user controls the precise value of this angle. Shank taper angle should not make contact with the work piece.

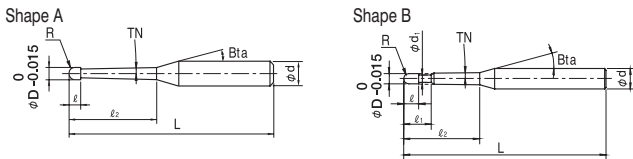
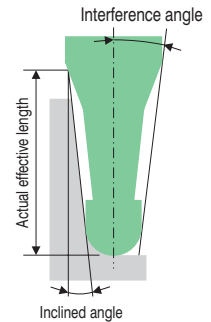

Unit (mm)

Model Number	Radius of Ball Nose R	Neck Taper Angle TN	Neck Length l_2	Interference Angle	Effective Length by Inclined Angles — : Interference					
					30°	1°	1°30'	2°	3°	
HTNB 2002-015-1	RO.1	30°	1.5	13.36°	—	1.50	1.55	1.60	1.72	
HTNB 2002-020-1			2	12.63°	—	2.01	2.08	2.15	2.31	
HTNB 2002-030-1			3	11.37°	—	3.05	3.15	3.26	3.50	
HTNB 2002-015-2		1°	1.5	13.41°	—	—	1.51	1.56	1.68	
HTNB 2002-020-2			2	12.69°	—	—	2.03	2.10	2.25	
HTNB 2002-030-2			3	11.46°	—	—	3.06	3.17	3.40	
HTNB 2002-015-3			1°30'	1.5	13.46°	—	—	—	1.53	1.64
HTNB 2002-020-3				2	12.76°	—	—	—	2.04	2.19
HTNB 2002-030-3				3	11.56°	—	—	—	3.08	3.31
HTNB 2003-020-1	RO.15	30°	2	12.62°	—	2.01	2.08	2.15	2.30	
HTNB 2003-030-1			3	11.34°	—	3.05	3.15	3.25	3.49	
HTNB 2003-020-2		1°	2	12.68°	—	—	2.03	2.10	2.25	
HTNB 2003-030-2			3	11.43°	—	—	3.06	3.17	3.40	
HTNB 2003-020-3		1°30'	2	12.75°	—	—	—	2.05	2.19	
HTNB 2003-030-3			3	11.52°	—	—	—	3.08	3.31	
HTNB 2004-030-1	RO.2	30°	3	11.30°	—	3.04	3.14	3.25	3.48	
HTNB 2004-040-1			4	10.23°	—	4.08	4.21	4.35	4.67	
HTNB 2004-060-1			6	8.60°	—	6.14	6.34	6.56	7.04	
HTNB 2004-030-2		1°	3	11.38°	—	—	3.06	3.17	3.39	
HTNB 2004-040-2			4	10.33°	—	—	4.10	4.23	4.54	
HTNB 2004-060-2			6	8.72°	—	—	6.16	6.37	6.84	
HTNB 2004-030-3		1°30'	3	11.48°	—	—	—	3.08	3.30	
HTNB 2004-040-3			4	10.44°	—	—	—	4.12	4.42	
HTNB 2004-060-3			6	8.84°	—	—	—	6.19	6.64	

Next Page →

φ3mm Shank
V Series

UDC-PCD
Series

CBN
Series

Square

Square

Long Neck
Square

Radius

Radius

Long Neck
Radius

Taper Neck
Radius

Ball

Ball / Long
Shank Ball

Long Neck
Ball

Taper Neck
Ball

Taper

Taper

Barrel

Spiral
V Cutter

Drill

Technical Data

Model Number	Radius of Ball Nose R	Neck Taper Angle TN	Neck Length ℓ_2	Effective Length ℓ_1	Length of Cut ℓ	Neck Diameter ϕd_1	Shank Taper Angle Bta	Overall Length L	Shank Diameter ϕd	Shape	Suggested Retail Price ¥
HTNB 2005-040-1	R0.25	30°	4	—	0.4	—	16°	50	4	A	8,400
HTNB 2005-060-1			6					8,880			
HTNB 2005-080-1			8					8,880			
HTNB 2005-100-1			10					9,600			
HTNB 2005-040-2		1°	4					8,400			
HTNB 2005-060-2			6					8,880			
HTNB 2005-080-2			8					8,880			
HTNB 2005-100-2			10					9,600			
HTNB 2005-040-3		1°30'	4					8,640			
HTNB 2005-060-3			6					8,880			
HTNB 2005-080-3			8					8,880			
HTNB 2005-100-3			10					9,600			
HTNB 2006-040-1	R0.3	30°	4	0.9	0.48	0.56	16°	50	4	B	8,280
HTNB 2006-060-1			6					8,520			
HTNB 2006-080-1			8					8,520			
HTNB 2006-100-1			10					8,640			
HTNB 2006-120-1			12					9,360			
HTNB 2006-140-1			14					9,360			
HTNB 2006-160-1			16					9,360			
HTNB 2006-200-1			20					12,500			
HTNB 2006-040-2		1°	4					8,280			
HTNB 2006-060-2			6					8,520			
HTNB 2006-080-2			8					8,520			
HTNB 2006-100-2			10					8,640			
HTNB 2006-120-2			12					9,360			
HTNB 2006-140-2			14					9,360			
HTNB 2006-160-2			16					9,360			
HTNB 2006-200-2			20					12,500			
HTNB 2006-040-3		1°30'	4					8,280			
HTNB 2006-060-3			6					8,520			
HTNB 2006-080-3			8					8,520			
HTNB 2006-100-3			10					8,640			
HTNB 2006-120-3	12		9,360								
HTNB 2006-140-3	14		9,360								
HTNB 2006-160-3	16		9,360								
HTNB 2006-200-3	20		12,500								
HTNB 2006-080-4	2°	8	8,520								
HTNB 2006-120-4		12	9,360								
HTNB 2006-200-4		20	12,500								
HTNB 2006-080-6		3°	8	8,520							
HTNB 2006-120-6	12		9,360								
HTNB 2006-200-6	20		12,500								
HTNB 2006-120-10	5°		12	9,360							
HTNB 2006-200-10		20	12,500								

- φ3mm Shank V Series
- UDC-PCD Series
- CBN Series
- Square
- Long Neck Square
- Radius
- Long Neck Radius
- Taper Neck Radius
- Ball / Long Shank Ball
- Long Neck Ball
- Taper Neck Ball
- Taper
- Barrel
- Spiral V Cutter
- Drill
- Technical Data

Unit (mm)

Model Number	Radius of Ball Nose R	Neck Taper Angle TN	Neck Length ℓ_2	Interference Angle	Effective Length by Inclined Angles — : Interference					
					30°	1°	1°30'	2°	3°	
HTNB 2005-040-1	R0.25	30°	4	10.17°	—	4.08	4.21	4.35	4.66	
HTNB 2005-060-1			6	8.52°	—	6.14	6.34	6.55	7.03	
HTNB 2005-080-1			8	7.33°	—	8.21	8.48	8.76	9.41	
HTNB 2005-100-1			10	6.43°	—	10.27	10.61	10.97	11.78	
HTNB 2005-040-2		1°	30°	4	10.27°	—	—	4.10	4.23	4.54
HTNB 2005-060-2				6	8.64°	—	—	6.16	6.37	6.84
HTNB 2005-080-2				8	7.45°	—	—	8.23	8.51	9.13
HTNB 2005-100-2				10	6.55°	—	—	10.30	10.65	11.43
HTNB 2005-040-3		1°30'	30°	4	10.38°	—	—	—	4.12	4.41
HTNB 2005-060-3				6	8.76°	—	—	—	6.19	6.64
HTNB 2005-080-3				8	7.57°	—	—	—	8.26	8.86
HTNB 2005-100-3				10	6.67°	—	—	—	10.33	11.09
HTNB 2006-040-1	R0.3	30°	4	10.10°	—	4.08	4.21	4.34	4.65	
HTNB 2006-060-1			6	8.44°	—	6.14	6.34	6.55	7.03	
HTNB 2006-080-1			8	7.24°	—	8.21	8.47	8.76	9.40	
HTNB 2006-100-1			10	6.33°	—	10.27	10.61	10.97	11.77	
HTNB 2006-120-1			12	5.63°	—	12.34	12.74	13.18	14.14	
HTNB 2006-140-1			14	5.07°	—	14.39	14.87	15.37	16.51	
HTNB 2006-160-1			16	4.61°	—	16.46	17.01	17.59	18.89	
HTNB 2006-200-1			20	3.90°	—	20.60	21.28	22.01	23.64	
HTNB 2006-040-2		1°	30°	4	10.21°	—	—	4.10	4.23	4.53
HTNB 2006-060-2				6	8.55°	—	—	6.17	6.37	6.83
HTNB 2006-080-2				8	7.36°	—	—	8.23	8.51	9.13
HTNB 2006-100-2				10	6.45°	—	—	10.30	10.65	11.43
HTNB 2006-120-2				12	5.74°	—	—	12.37	12.79	13.72
HTNB 2006-140-2				14	5.18°	—	—	14.43	14.93	16.03
HTNB 2006-160-2				16	4.71°	—	—	16.50	17.07	18.32
HTNB 2006-200-2				20	3.99°	—	—	20.64	21.34	22.92
HTNB 2006-040-3		1°30'	30°	4	10.31°	—	—	—	4.12	4.41
HTNB 2006-060-3				6	8.67°	—	—	—	6.19	6.64
HTNB 2006-080-3				8	7.48°	—	—	—	8.26	8.86
HTNB 2006-100-3				10	6.57°	—	—	—	10.34	11.09
HTNB 2006-120-3				12	5.86°	—	—	—	12.40	13.31
HTNB 2006-140-3				14	5.29°	—	—	—	14.46	15.52
HTNB 2006-160-3				16	4.82°	—	—	—	16.54	17.76
HTNB 2006-200-3				20	4.09°	—	—	—	20.67	22.19
HTNB 2006-080-4	2°	30°	8	7.60°	—	—	—	8.59		
HTNB 2006-120-4			12	5.98°	—	—	—	12.89		
HTNB 2006-200-4			20	4.19°	—	—	—	21.49		
HTNB 2006-080-6	3°	30°	8	7.86°	—	—	—	—		
HTNB 2006-120-6			12	6.23°	—	—	—	—		
HTNB 2006-200-6			20	4.41°	—	—	—	—		
HTNB 2006-120-10	5°	30°	12	6.82°	—	—	—	—		
HTNB 2006-200-10			20	4.92°	—	—	—	—		

Ø3mm Shank
V SeriesUDC-PCD
SeriesCBN
SeriesSquare
Long Neck
Square

Radius

Long Neck
RadiusTaper Neck
RadiusBall / Long
Shank BallLong Neck
BallTaper Neck
Ball

Taper

Barrel

Spiral
V Cutter

Drill

Technical Data

Model Number	Radius of Ball Nose R	Neck Taper Angle TN	Neck Length ℓ_2	Effective Length ℓ_1	Length of Cut ℓ	Neck Diameter ϕd_1	Shank Taper Angle B α	Overall Length L	Shank Diameter ϕd	Shape	Suggested Retail Price ¥
HTNB 2008-060-1	RO.4	30°	6	1.2	0.64	0.76	16°	50	4	B	8,880
HTNB 2008-080-1			8					50	4		8,880
HTNB 2008-120-1			12					60	4		9,360
HTNB 2008-160-1			16					60	4		11,500
HTNB 2008-060-2		1°	6					50	4		8,880
HTNB 2008-080-2			8					50	4		8,880
HTNB 2008-120-2			12					60	4		9,360
HTNB 2008-160-2			16					60	4		11,500
HTNB 2008-060-3		1°30'	6					50	4		8,880
HTNB 2008-080-3			8					50	4		8,880
HTNB 2008-120-3			12					60	4		9,360
HTNB 2008-160-3			16					60	4		11,500
HTNB 2010-060-1	RO.5	30°	6	1.5	0.8	0.95	16°	50	4	B	7,560
HTNB 2010-080-1			8					50	4		7,560
HTNB 2010-100-1			10					50	4		7,560
HTNB 2010-120-1			12					50	4		7,560
HTNB 2010-140-1			14					50	4		7,560
HTNB 2010-160-1			16					50	4		7,560
HTNB 2010-180-1		18	50					4	7,560		
HTNB 2010-200-1		20	60					4	9,600		
HTNB 2010-220-1		22	60					4	9,600		
HTNB 2010-260-1		26	65					4	10,080		
HTNB 2010-300-1		30	70					4	10,560		
HTNB 2010-320-1		32	70					4	10,560		
HTNB 2010-360-1	36	80	4	11,040							

φ3mm Shank V Series

UDC-PCD Series

CBN Series

Square
Long Neck Square

Radius
Long Neck Radius
Taper Neck Radius

Ball / Long Shank Ball
Long Neck Ball
Taper Neck Ball

Taper

Barrel

Spiral V Cutter

Drill

Technical Data

Unit (mm)

Model Number	Radius of Ball Nose R	Neck Taper Angle TN	Neck Length ℓ_2	Interference Angle	Effective Length by Inclined Angles — : Interference				
					30°	1°	1°30'	2°	3°
HTNB 2008-060-1	RO.4	30°	6	8.26°	—	6.14	6.34	6.54	7.01
HTNB 2008-080-1			8	7.04°	—	8.21	8.47	8.75	9.38
HTNB 2008-120-1			12	5.44°	—	12.33	12.74	13.17	14.13
HTNB 2008-160-1			16	4.43°	—	16.47	17.01	17.59	18.88
HTNB 2008-060-2		1°	6	8.37°	—	—	6.17	6.37	6.82
HTNB 2008-080-2			8	7.16°	—	—	8.23	8.51	9.12
HTNB 2008-120-2			12	5.55°	—	—	12.37	12.79	13.72
HTNB 2008-160-2			16	4.53°	—	—	16.50	17.06	18.31
HTNB 2008-060-3		1°30'	6	8.49°	—	—	—	6.20	6.64
HTNB 2008-080-3			8	7.28°	—	—	—	8.26	8.86
HTNB 2008-120-3			12	5.67°	—	—	—	12.40	13.30
HTNB 2008-160-3			16	4.63°	—	—	—	16.54	17.75
HTNB 2010-060-1	RO.5	30°	6	8.06°	—	6.14	6.33	6.54	7.00
HTNB 2010-080-1			8	6.84°	—	8.21	8.47	8.75	9.37
HTNB 2010-100-1			10	5.93°	—	10.27	10.60	10.96	11.74
HTNB 2010-120-1			12	5.24°	—	12.33	12.73	13.16	14.11
HTNB 2010-140-1			14	4.69°	—	14.39	14.85	15.35	16.47
HTNB 2010-160-1			16	4.25°	—	16.46	17.00	17.58	18.86
HTNB 2010-180-1			18	3.88°	—	18.51	19.12	19.77	21.21
HTNB 2010-200-1			20	3.57°	—	20.60	21.27	22.00	23.61
HTNB 2010-220-1			22	3.31°	—	22.66	23.41	24.20	25.98
HTNB 2010-260-1			26	2.88°	—	26.79	27.67	28.62	No Interference
HTNB 2010-300-1			30	2.55°	—	30.90	31.93	33.02	No Interference
HTNB 2010-320-1			32	2.41°	—	32.98	34.07	35.24	No Interference
HTNB 2010-360-1	36	2.18°	—	37.11	38.34	39.66	No Interference		

Next Page ➔

Ø3mm Shank
V SeriesUDC-PCD
SeriesCBN
SeriesSquare
Long Neck
SquareRadius
Long Neck
RadiusTaper Neck
RadiusBall / Long
Shank BallLong Neck
BallTaper Neck
Ball

Taper

Barrel

Spiral
V Cutter

Drill

Technical Data

Model Number	Radius of Ball Nose R	Neck Taper Angle TN	Neck Length ℓ_2	Effective Length ℓ_1	Length of Cut ℓ	Neck Diameter ϕd_1	Shank Taper Angle Bta	Overall Length L	Shank Diameter ϕd	Shape	Suggested Retail Price ¥	
HTNB 2010-060-2	RO.5	1°	6	1.5	0.8	0.95	16°	50	4	B	7,560	
HTNB 2010-080-2			8					50	4		7,560	
HTNB 2010-100-2			10					50	4		7,560	
HTNB 2010-120-2			12					50	4		7,560	
HTNB 2010-140-2			14					50	4		7,560	
HTNB 2010-160-2			16					50	4		7,560	
HTNB 2010-180-2			18					50	4		7,560	
HTNB 2010-200-2			20					60	4		9,600	
HTNB 2010-220-2			22					60	4		9,600	
HTNB 2010-260-2			26					65	4		10,080	
HTNB 2010-300-2			30					70	4		10,560	
HTNB 2010-320-2			32					70	4		10,560	
HTNB 2010-360-2			36					80	4		11,040	
HTNB 2010-060-3			1°30'					6	50		4	7,560
HTNB 2010-080-3		8						50	4		7,560	
HTNB 2010-100-3		10						50	4		7,560	
HTNB 2010-120-3		12						50	4		7,560	
HTNB 2010-140-3		14						50	4		7,560	
HTNB 2010-160-3		16						50	4		7,560	
HTNB 2010-180-3		18						50	4		7,560	
HTNB 2010-200-3		20						60	4		9,600	
HTNB 2010-220-3		22						60	4		9,600	
HTNB 2010-260-3		26						65	4		10,080	
HTNB 2010-300-3		30						70	4		10,560	
HTNB 2010-320-3		32						70	4		10,560	
HTNB 2010-360-3		36						80	4		11,040	
HTNB 2010-120-4		2°						12	50		4	7,560
HTNB 2010-160-4			16					50	4		7,560	
HTNB 2010-200-4			20					60	4		9,600	
HTNB 2010-300-4			30					70	4		10,560	
HTNB 2010-120-6		3°	12					50	4		7,560	
HTNB 2010-160-6			16					50	4		7,560	
HTNB 2010-200-6			20					60	4		9,600	
HTNB 2010-298-6			29.8					—	70		4	C
HTNB 2010-120-10		5°	12					50	4		7,560	
HTNB 2010-200-10			20					70	6		B	9,600

φ3mm Shank V Series

UDC-PCD Series

CBN Series

Square Long Neck Square

Radius

Long Neck Radius Taper Neck Radius

Ball / Long Shank Ball Long Neck Ball Taper Neck Ball

Taper

Barrel

Spiral V Cutter

Drill

Technical Data

Unit (mm)

Model Number	Radius of Ball Nose R	Neck Taper Angle TN	Neck Length ℓ_2	Interference Angle	Effective Length by Inclined Angles — : Interference					
					30°	1°	1°30'	2°	3°	
HTNB 2010-060-2	RO.5	1°	6	8.17°	—	—	6.18	6.38	6.82	
HTNB 2010-080-2			8	6.95°	—	—	8.24	8.51	9.12	
HTNB 2010-100-2			10	6.04°	—	—	10.31	10.66	11.42	
HTNB 2010-120-2			12	5.35°	—	—	12.38	12.79	13.72	
HTNB 2010-140-2			14	4.79°	—	—	14.45	14.93	16.02	
HTNB 2010-160-2			16	4.34°	—	—	16.51	17.07	18.31	
HTNB 2010-180-2			18	3.97°	—	—	18.58	19.21	20.61	
HTNB 2010-200-2			20	3.65°	—	—	20.64	21.35	22.91	
HTNB 2010-220-2			22	3.39°	—	—	22.71	23.48	25.21	
HTNB 2010-260-2			26	2.95°	—	—	26.85	27.76	No Interference	
HTNB 2010-300-2			30	2.62°	—	—	30.97	32.03	No Interference	
HTNB 2010-320-2			32	2.48°	—	—	33.05	34.18	No Interference	
HTNB 2010-360-2		36	2.24°	—	—	37.18	38.46	No Interference		
HTNB 2010-060-3		1°30'	1°30'	6	8.28°	—	—	—	6.21	6.65
HTNB 2010-080-3				8	7.06°	—	—	—	8.28	8.87
HTNB 2010-100-3				10	6.16°	—	—	—	10.35	11.10
HTNB 2010-120-3				12	5.45°	—	—	—	12.42	13.32
HTNB 2010-140-3				14	4.90°	—	—	—	14.47	15.52
HTNB 2010-160-3				16	4.44°	—	—	—	16.56	17.77
HTNB 2010-180-3				18	4.06°	—	—	—	18.61	19.97
HTNB 2010-200-3				20	3.74°	—	—	—	20.70	22.21
HTNB 2010-220-3				22	3.47°	—	—	—	22.77	24.44
HTNB 2010-260-3				26	3.03°	—	—	—	26.91	28.88
HTNB 2010-300-3				30	2.69°	—	—	—	31.03	No Interference
HTNB 2010-320-3				32	2.55°	—	—	—	33.11	No Interference
HTNB 2010-360-3		36	2.30°	—	—	—	37.25	No Interference		
HTNB 2010-120-4		2°	2°	12	5.57°	—	—	—	12.88	
HTNB 2010-160-4				16	4.55°	—	—	—	17.18	
HTNB 2010-200-4				20	3.84°	—	—	—	21.48	
HTNB 2010-300-4				30	2.77°	—	—	—	No Interference	
HTNB 2010-120-6		3°	3°	12	5.82°	—	—	—	—	
HTNB 2010-160-6				16	4.77°	—	—	—	—	
HTNB 2010-200-6				20	4.05°	—	—	—	—	
HTNB 2010-298-6				29.8	—	—	—	—	—	
HTNB 2010-120-10		5°	5°	12	6.38°	—	—	—	—	
HTNB 2010-200-10				20	6.35°	—	—	—	—	

Ø3mm Shank
V SeriesUDC-PCD
SeriesCBN
Series

Square

Long Neck
Square

Radius

Long Neck
RadiusTaper Neck
RadiusBall / Long
Shank BallLong Neck
BallTaper Neck
Ball

Taper

Barrel

Spiral
V Cutter

Drill

Technical Data

Next Page →

2 Flutes HARDMAX

Model Number	Radius of Ball Nose R	Neck Taper Angle TN	Neck Length ℓ_2	Effective Length ℓ_1	Length of Cut ℓ	Neck Diameter ϕd_1	Shank Taper Angle Bta	Overall Length L	Shank Diameter ϕd	Shape	Suggested Retail Price ¥	
HTNB 2015-100-1	R0.75	30°	10	2.25	1.2	1.42	16°	60	4	B	7,920	
HTNB 2015-120-1			12					60	4		7,920	
HTNB 2015-160-1			16					60	4		8,640	
HTNB 2015-200-1			20					60	4		8,640	
HTNB 2015-220-1			22					60	4		8,640	
HTNB 2015-260-1			26					70	4		9,360	
HTNB 2015-300-1			30					70	4		9,360	
HTNB 2015-360-1			36					80	4		11,040	
HTNB 2015-100-2			1°					10	60		4	7,920
HTNB 2015-120-2		12						60	4		7,920	
HTNB 2015-160-2		16						60	4		8,640	
HTNB 2015-200-2		20						60	4		8,640	
HTNB 2015-260-2		26						70	4		9,360	
HTNB 2015-300-2		30						70	4		9,360	
HTNB 2015-360-2		36						80	4		11,040	
HTNB 2015-100-3		1°30'						10	60		4	7,920
HTNB 2015-120-3								12	60		4	7,920
HTNB 2015-160-3			16					60	4		8,640	
HTNB 2015-200-3			20					60	4		8,640	
HTNB 2015-260-3			26					70	4		9,360	
HTNB 2015-300-3			30					70	4		9,360	
HTNB 2015-360-3			36					80	4		11,040	
HTNB 2015-120-4			2°					12	60		4	7,920
HTNB 2015-160-4								16	60		4	8,640
HTNB 2015-200-4		20						60	4		8,640	
HTNB 2015-300-4		3°	30					70	6		11,040	
HTNB 2015-120-6			12					60	4		7,920	
HTNB 2015-160-6			16					60	4		8,640	
HTNB 2015-200-6		3°	20					60	4		8,640	
HTNB 2015-300-6			30					70	6		11,040	

φ3mm Shank V Series

UDC-PCD Series

CBN Series

Square

Long Neck Square

Radius

Long Neck Radius

Taper Neck Radius

Ball / Long Shank Ball

Long Neck Ball

Taper Neck Ball

Taper

Barrel

Spiral V Cutter

Drill

Technical Data

Unit (mm)

Model Number	Radius of Ball Nose R	Neck Taper Angle TN	Neck Length ℓ_2	Interference Angle	Effective Length by Inclined Angles — : Interference					
					30°	1°	1°30'	2°	3°	
HTNB 2015-100-1	R0.75	30°	10	5.36°	—	10.27	10.59	10.93	11.70	
HTNB 2015-120-1			12	4.69°	—	12.33	12.72	13.14	14.08	
HTNB 2015-160-1			16	3.75°	—	16.46	16.99	17.56	18.82	
HTNB 2015-200-1			20	3.12°	—	20.59	21.26	21.98	23.57	
HTNB 2015-220-1			22	2.88°	—	22.66	23.39	24.18	No Interference	
HTNB 2015-260-1			26	2.50°	—	26.79	27.66	28.60	No Interference	
HTNB 2015-300-1			30	2.20°	—	30.92	31.93	33.01	No Interference	
HTNB 2015-360-1			36	1.87°	—	37.11	38.33	No Interference	No Interference	
HTNB 2015-100-2			1°	10	5.46°	—	—	10.31	10.65	11.39
HTNB 2015-120-2		12		4.79°	—	—	12.38	12.78	13.69	
HTNB 2015-160-2		16		3.83°	—	—	16.51	17.06	18.29	
HTNB 2015-200-2		20		3.20°	—	—	20.65	21.34	22.89	
HTNB 2015-260-2		26		2.56°	—	—	26.85	27.76	No Interference	
HTNB 2015-300-2		30		2.26°	—	—	30.98	32.03	No Interference	
HTNB 2015-360-2		36		1.92°	—	—	37.18	No Interference	No Interference	
HTNB 2015-100-3		1°30'		10	5.57°	—	—	—	10.36	11.09
HTNB 2015-120-3				12	4.89°	—	—	—	12.43	13.31
HTNB 2015-160-3			16	3.92°	—	—	—	16.57	17.76	
HTNB 2015-200-3			20	3.28°	—	—	—	20.71	22.21	
HTNB 2015-260-3			26	2.63°	—	—	—	26.91	No Interference	
HTNB 2015-300-3			30	2.32°	—	—	—	31.05	No Interference	
HTNB 2015-360-3			36	1.98°	—	—	—	No Interference	No Interference	
HTNB 2015-120-4			2°	12	4.98°	—	—	—	—	12.90
HTNB 2015-160-4				16	4.02°	—	—	—	—	17.20
HTNB 2015-200-4		20		3.36°	—	—	—	—	21.50	
HTNB 2015-300-4		30		3.84°	—	—	—	—	32.25	
HTNB 2015-120-6		3°	12	5.21°	—	—	—	—	—	
HTNB 2015-160-6			16	4.22°	—	—	—	—	—	
HTNB 2015-200-6			20	3.55°	—	—	—	—	—	
HTNB 2015-300-6			30	4.04°	—	—	—	—	—	

Next Page →

Ø3mm Shank
V SeriesUDC-PCD
SeriesCBN
SeriesSquare
Long Neck
Square

Radius

Long Neck
RadiusTaper Neck
RadiusBall / Long
Shank BallLong Neck
BallTaper Neck
Ball

Taper

Barrel

Spiral
V Cutter

Drill

Technical Data

2 Flutes HARDMAX

Model Number	Radius of Ball Nose R	Neck Taper Angle TN	Neck Length ℓ_2	Effective Length ℓ_1	Length of Cut ℓ	Neck Diameter ϕd_1	Shank Taper Angle Bta	Overall Length L	Shank Diameter ϕd	Shape	Suggested Retail Price ¥		
HTNB 2020-120-1	R1	30°	12	3	1.6	1.91	16°	60	4	B	8,100		
HTNB 2020-160-1			16					60	4		8,100		
HTNB 2020-200-1			20					60	4		8,640		
HTNB 2020-220-1			22					60	4		8,640		
HTNB 2020-240-1			24					60	4		9,600		
HTNB 2020-260-1			26					60	4		9,600		
HTNB 2020-280-1			28					70	4		10,560		
HTNB 2020-300-1			30					70	4		10,560		
HTNB 2020-320-1			32					70	4		10,560		
HTNB 2020-340-1			34					70	4		11,040		
HTNB 2020-360-1			36					80	4		11,040		
HTNB 2020-400-1			40					80	4		12,480		
HTNB 2020-100-2			1°					30°	10		60	4	8,100
HTNB 2020-120-2									12		60	4	8,100
HTNB 2020-160-2		16							60		4	8,100	
HTNB 2020-200-2		20							60		4	8,640	
HTNB 2020-220-2		22							60		4	8,640	
HTNB 2020-240-2		24							60		4	9,600	
HTNB 2020-260-2		26							60		4	9,600	
HTNB 2020-280-2		28							70		4	10,560	
HTNB 2020-300-2		30							70		4	10,560	
HTNB 2020-320-2		32							70		4	10,560	
HTNB 2020-340-2		34							70		4	11,040	
HTNB 2020-360-2		36							80		4	11,040	
HTNB 2020-400-2		40							80		4	13,100	
HTNB 2020-100-3		1°30'							30°		10	60	4
HTNB 2020-120-3								12			60	4	8,100
HTNB 2020-160-3								16			60	4	8,100
HTNB 2020-200-3								20			60	4	8,640
HTNB 2020-220-3								22			60	4	8,640
HTNB 2020-240-3								24			60	4	9,600
HTNB 2020-260-3								26			60	4	9,600
HTNB 2020-280-3								28			70	4	10,560
HTNB 2020-300-3								30			70	4	10,560
HTNB 2020-320-3								32			70	4	10,560
HTNB 2020-340-3								34			70	4	11,040
HTNB 2020-360-3								36			80	4	11,040
HTNB 2020-400-3								40			80	4	13,100
HTNB 2020-120-4								2°			30°	12	60
HTNB 2020-160-4		16							60			4	8,100
HTNB 2020-200-4	20	60	4	8,640									
HTNB 2020-300-4	30	70	6	11,440									
HTNB 2020-400-4	40	80	6	13,980									
HTNB 2020-120-6	3°	30°	12	60	4	8,100							
HTNB 2020-160-6			16	60	4	8,100							
HTNB 2020-200-6		20	60	4	8,640								
HTNB 2020-300-6		30	70	6	11,440								
HTNB 2020-400-6		40	80	6	13,980								

φ3mm Shank V Series

UDC-PCD Series

CBN Series

Square
Long Neck Square

Radius

Long Neck Radius
Taper Neck Radius

Ball / Long Shank Ball

Long Neck Ball
Taper Neck Ball

Taper

Barrel

Spiral V Cutter

Drill

Technical Data

Unit (mm)

Model Number	Radius of Ball Nose R	Neck Taper Angle TN	Neck Length ℓ_2	Interference Angle	Effective Length by Inclined Angles — : Interference						
					30°	1°	1°30'	2°	3°		
HTNB 2020-120-1	R1	30°	12	4.05°	—	12.34	12.72	13.14	14.05		
HTNB 2020-160-1			16	3.19°	—	16.47	16.99	17.55	18.80		
HTNB 2020-200-1			20	2.63°	—	20.60	21.26	21.97	No Interference		
HTNB 2020-220-1			22	2.42°	—	22.66	23.39	24.17	No Interference		
HTNB 2020-240-1			24	2.23°	—	24.73	25.53	26.38	No Interference		
HTNB 2020-260-1			26	2.08°	—	26.79	27.66	28.59	No Interference		
HTNB 2020-280-1			28	1.94°	—	28.86	29.80	No Interference	No Interference		
HTNB 2020-300-1			30	1.83°	—	30.92	31.93	No Interference	No Interference		
HTNB 2020-320-1			32	1.72°	—	32.99	34.07	No Interference	No Interference		
HTNB 2020-340-1			34	1.63°	—	35.05	36.20	No Interference	No Interference		
HTNB 2020-360-1			36	1.54°	—	37.12	38.33	No Interference	No Interference		
HTNB 2020-400-1			40	1.40°	—	41.25	No Interference	No Interference	No Interference		
HTNB 2020-100-2			1°	1°	10	4.77°	—	—	10.34	10.66	11.40
HTNB 2020-120-2					12	4.13°	—	—	12.40	12.80	13.69
HTNB 2020-160-2		16			3.26°	—	—	16.53	17.08	18.29	
HTNB 2020-200-2		20			2.69°	—	—	20.67	21.35	No Interference	
HTNB 2020-220-2		22			2.48°	—	—	22.73	23.49	No Interference	
HTNB 2020-240-2		24			2.29°	—	—	24.80	25.63	No Interference	
HTNB 2020-260-2		26			2.13°	—	—	26.87	27.77	No Interference	
HTNB 2020-280-2		28			2.00°	—	—	28.94	29.91	No Interference	
HTNB 2020-300-2		30			1.88°	—	—	31.00	No Interference	No Interference	
HTNB 2020-320-2		32			1.77°	—	—	33.07	No Interference	No Interference	
HTNB 2020-340-2		34			1.67°	—	—	35.14	No Interference	No Interference	
HTNB 2020-360-2		36			1.59°	—	—	37.20	No Interference	No Interference	
HTNB 2020-400-2		40			1.44°	—	—	No Interference	No Interference	No Interference	
HTNB 2020-100-3		1°30'			1°30'	10	4.83°	—	—	10.38	11.09
HTNB 2020-120-3			12	4.22°		—	—	—	12.46	13.33	
HTNB 2020-160-3			16	3.34°		—	—	—	16.60	17.78	
HTNB 2020-200-3			20	2.76°		—	—	—	20.74	No Interference	
HTNB 2020-220-3			22	2.54°		—	—	—	22.81	No Interference	
HTNB 2020-240-3			24	2.35°		—	—	—	24.88	No Interference	
HTNB 2020-260-3			26	2.19°		—	—	—	26.95	No Interference	
HTNB 2020-280-3			28	2.05°		—	—	—	29.02	No Interference	
HTNB 2020-300-3			30	1.93°		—	—	—	No Interference	No Interference	
HTNB 2020-320-3			32	1.82°		—	—	—	No Interference	No Interference	
HTNB 2020-340-3			34	1.72°		—	—	—	No Interference	No Interference	
HTNB 2020-360-3			36	1.63°		—	—	—	No Interference	No Interference	
HTNB 2020-400-3			40	1.48°		—	—	—	No Interference	No Interference	
HTNB 2020-120-4			2°	2°		12	4.29°	—	—	—	12.97
HTNB 2020-160-4		16			3.41°	—	—	—	—	17.26	
HTNB 2020-200-4	20	2.83°			—	—	—	—	No Interference		
HTNB 2020-300-4	30	3.52°			—	—	—	—	32.31		
HTNB 2020-400-4	40	2.78°	—	—	—	—	No Interference				
HTNB 2020-120-6	3°	3°	12	4.48°	—	—	—	—			
HTNB 2020-160-6			16	3.58°	—	—	—	—	—		
HTNB 2020-200-6			20	2.98°	—	—	—	—	—		
HTNB 2020-300-6			30	3.71°	—	—	—	—	—		
HTNB 2020-400-6	40	2.94°	—	—	—	—	—				

Ø3mm Shank
V SeriesUDC-PCD
SeriesCBN
SeriesSquare
Long Neck
SquareRadius
Long Neck
RadiusTaper Neck
RadiusBall / Long
Shank BallBall
Long Neck
BallTaper Neck
Ball

Taper

Barrel

Spiral
V Cutter

Drill

Technical Data

2 Flutes HARDMAX

Model Number	Radius of Ball Nose R	Neck Taper Angle TN	Neck Length ℓ_2	Effective Length ℓ_1	Length of Cut ℓ	Neck Diameter ϕd_1	Shank Taper Angle Bta	Overall Length L	Shank Diameter ϕd	Shape	Suggested Retail Price ¥							
HTNB 2030-200-1	R1.5	30°	20	4.5	2.4	2.89	16°	60	6	B	9,740							
HTNB 2030-220-1			22					60	6		9,740							
HTNB 2030-260-1			26					70	6		10,400							
HTNB 2030-300-1			30					70	6		11,880							
HTNB 2030-320-1			32					70	6		12,480							
HTNB 2030-360-1			36					80	6		13,000							
HTNB 2030-400-1			40					80	6		13,200							
HTNB 2030-420-1			42					90	6		13,680							
HTNB 2030-520-1			52					100	6		15,360							
HTNB 2030-200-2			1°					20	60		6	9,740						
HTNB 2030-260-2		26						70	6		10,400							
HTNB 2030-300-2		30						70	6		11,880							
HTNB 2030-320-2		32						70	6		12,480							
HTNB 2030-360-2		36						80	6		13,000							
HTNB 2030-400-2		40						80	6		13,200							
HTNB 2030-420-2		42						90	6		13,680							
HTNB 2030-480-2		48						100	6		15,360							
HTNB 2030-520-2		52						100	6		15,360							
HTNB 2030-620-2		62						100	6		18,230							
HTNB 2030-200-3		1°30'	20					60	6		9,740							
HTNB 2030-260-3			26					70	6		10,400							
HTNB 2030-300-3			30					70	6		11,880							
HTNB 2030-320-3			32					70	6		12,480							
HTNB 2030-360-3			36					80	6		13,000							
HTNB 2030-400-3			40					80	6		13,200							
HTNB 2030-420-3			42					90	6		13,680							
HTNB 2030-580-3			58					100	6		15,360							
HTNB 2040-300-1			R2					30°	30		6	3.2	3.87	16°	80	6	B	11,590
HTNB 2040-400-1									40						80	6		15,000
HTNB 2040-620-1		62							120						6	19,200		
HTNB 2040-200-2	1°	20		80	6	11,590												
HTNB 2040-300-2		30		80	6	11,590												
HTNB 2040-360-2		36		80	6	13,420												
HTNB 2040-400-2		40		80	6	15,000												
HTNB 2040-600-2		60		120	6	19,200												
HTNB 2040-410-3		41		80	6	15,000												
HTNB 2040-600-3		60		120	8	28,000												
HTNB 2040-800-3		80		130	8	30,360												
		—													C			

φ3mm Shank V Series

UDC-PCD Series

CBN Series

Square
Long Neck Square

Radius

Long Neck Radius
Taper Neck Radius

Ball / Long Shank Ball
Long Neck Ball
Taper Neck Ball

Taper

Barrel

Spiral V Cutter

Drill

Technical Data

Unit (mm)

Model Number	Radius of Ball Nose R	Neck Taper Angle TN	Neck Length ℓ_2	Interference Angle	Effective Length by Inclined Angles — : Interference						
					30°	1°	1°30'	2°	3°		
HTNB 2030-200-1	R1.5	30°	20	3.71°	—	20.59	21.23	21.92	23.46		
HTNB 2030-220-1			22	3.43°	—	22.65	23.36	24.13	25.83		
HTNB 2030-260-1			26	2.97°	—	26.78	27.63	28.54	No Interference		
HTNB 2030-300-1			30	2.62°	—	30.91	31.90	32.96	No Interference		
HTNB 2030-320-1			32	2.48°	—	32.98	34.04	35.17	No Interference		
HTNB 2030-360-1			36	2.23°	—	37.11	38.30	39.58	No Interference		
HTNB 2030-400-1			40	2.03°	—	41.23	42.57	44.00	No Interference		
HTNB 2030-420-1			42	1.94°	—	43.30	44.70	No Interference	No Interference		
HTNB 2030-520-1			52	1.60°	—	53.62	55.38	No Interference	No Interference		
HTNB 2030-200-2			1°	20	3.79°	—	—	20.66	21.33	22.83	
HTNB 2030-260-2		26		3.04°	—	—	26.87	27.75	29.72		
HTNB 2030-300-2		30		2.69°	—	—	31.00	32.03	No Interference		
HTNB 2030-320-2		32		2.54°	—	—	33.07	34.17	No Interference		
HTNB 2030-360-2		36		2.29°	—	—	37.20	38.44	No Interference		
HTNB 2030-400-2		40		2.08°	—	—	41.33	42.72	No Interference		
HTNB 2030-420-2		42		1.99°	—	—	43.40	No Interference	No Interference		
HTNB 2030-480-2		48		1.77°	—	—	49.60	No Interference	No Interference		
HTNB 2030-520-2		52		1.64°	—	—	53.74	No Interference	No Interference		
HTNB 2030-620-2		62		1.39°	—	—	No Interference	No Interference	No Interference		
HTNB 2030-200-3		1°30'	20	3.88°	—	—	—	20.75	22.20		
HTNB 2030-260-3			26	3.12°	—	—	—	26.96	28.87		
HTNB 2030-300-3			30	2.76°	—	—	—	31.09	No Interference		
HTNB 2030-320-3			32	2.61°	—	—	—	33.16	No Interference		
HTNB 2030-360-3			36	2.35°	—	—	—	37.30	No Interference		
HTNB 2030-400-3			40	2.14°	—	—	—	41.44	No Interference		
HTNB 2030-420-3			42	2.05°	—	—	—	43.51	No Interference		
HTNB 2030-580-3			58	1.53°	—	—	—	No Interference	No Interference		
HTNB 2040-300-1			R2	30°	30	1.88°	—	30.91	31.88	No Interference	No Interference
HTNB 2040-400-1					40	1.43°	—	41.23	No Interference	No Interference	No Interference
HTNB 2040-620-1		62			0.94°	—	No Interference	No Interference	No Interference	No Interference	
HTNB 2040-200-2		1°		20	2.81°	—	—	20.67	21.32	No Interference	
HTNB 2040-300-2				30	1.93°	—	—	31.00	No Interference	No Interference	
HTNB 2040-360-2	36			1.63°	—	—	37.21	No Interference	No Interference		
HTNB 2040-400-2	40			1.47°	—	—	No Interference	No Interference	No Interference		
HTNB 2040-600-2	60			1.00°	—	—	No Interference	No Interference	No Interference		
HTNB 2040-410-3	1°30'			41	1.48°	—	—	—	No Interference	No Interference	
HTNB 2040-600-3		60		1.92°	—	—	—	No Interference	No Interference		
HTNB 2040-800-3		80		—	—	—	—	No Interference	No Interference		

Ø3mm Shank
V SeriesUDC-PCD
SeriesCBN
Series

Square

Square
Long Neck
Square

Radius

Radius
Long Neck
RadiusTaper Neck
RadiusBall / Long
Shank BallBall
Long Neck
BallTaper Neck
Ball

Taper

Barrel

Spiral
V Cutter

Drill

Technical Data

Milling Conditions for HTNB

WORK MATERIAL				COPPER / CARBON STEELS Cu / S45C / S50C					PREHARDENED STEELS / HARDENED STEELS NAK / SKD (30~45HRC)							
Model Number	Radius of Ball Nose (mm)	Neck Taper Angle	Neck Length (mm)	Spindle Speed (min ⁻¹)	Feed Rate (mm/min)	a _p Axial Depth (mm)	a _e Radial Depth		Spindle Speed (min ⁻¹)	Feed Rate (mm/min)	a _p Axial Depth (mm)	a _e Radial Depth				
							Roughing (mm)	Finishing (mm)				Roughing (mm)	Finishing (mm)			
2002	R0.1	1°30' or below	1.5	42,000	640	0.008	0.02	0.015	29,000	430	0.006	0.02	0.015			
			2	33,000	370	0.006	0.02	0.011	23,500	260	0.005	0.02	0.011			
			3	27,000	270	0.002	0.02	0.01	19,000	165	0.001	0.02	0.009			
2003	R0.15	1°30' or below	2	36,000	650	0.009	0.03	0.018	25,200	400	0.007	0.03	0.016			
			3	33,000	500	0.004	0.03	0.015	23,000	330	0.003	0.03	0.014			
2004	R0.2	1°30' or below	3	42,000	1,300	0.018	0.04	0.031	29,000	800	0.014	0.04	0.028			
			4	33,000	800	0.008	0.04	0.024	23,000	520	0.006	0.04	0.023			
			6	27,000	550	0.005	0.04	0.02	19,000	330	0.004	0.04	0.017			
2005	R0.25	1°30' or below	4	36,000	1,330	0.02	0.05	0.037	28,000	870	0.016	0.05	0.031			
			6	29,000	900	0.012	0.05	0.031	23,000	650	0.009	0.05	0.028			
			8	23,500	600	0.007	0.05	0.026	19,000	450	0.006	0.05	0.024			
			10	20,000	480	0.004	0.05	0.024	18,000	380	0.003	0.05	0.021			
2006	R0.3	1°30' or below	4	44,000	2,340	0.032	0.06	0.053	32,500	1,500	0.025	0.06	0.046			
			6	36,000	1,500	0.018	0.06	0.042	29,000	1,100	0.014	0.06	0.038			
			8	28,500	1,150	0.018	0.06	0.04	24,000	770	0.014	0.06	0.032			
			10	28,500	950	0.014	0.06	0.033	24,000	720	0.011	0.06	0.03			
			12	28,500	950	0.009	0.06	0.033	24,000	720	0.007	0.06	0.03			
			14	26,500	800	0.007	0.06	0.03	23,000	660	0.005	0.06	0.029			
			16	25,000	700	0.005	0.06	0.028	22,000	600	0.004	0.06	0.027			
			20	20,000	400	0.003	0.06	0.02	17,000	330	0.002	0.06	0.019			
			8	28,500	1,380	0.022	0.09	0.048	24,000	920	0.017	0.09	0.038			
			12	28,500	1,140	0.011	0.09	0.04	24,000	860	0.008	0.09	0.036			
20	20,000	480	0.004	0.09	0.024	17,000	400	0.002	0.09	0.024						
2008	R0.4	1°30' or below	6	36,000	2,000	0.023	0.08	0.056	24,000	1,300	0.019	0.08	0.054			
			8	28,500	1,500	0.023	0.08	0.053	20,000	950	0.019	0.08	0.048			
			12	28,500	1,200	0.018	0.08	0.042	16,500	600	0.014	0.08	0.036			
			16	25,000	900	0.01	0.08	0.036	15,000	500	0.008	0.08	0.033			
2010	R0.5	1°30' or below	6	35,000	2,900	0.05	0.1	0.083	23,000	1,850	0.04	0.1	0.08			
			8	28,000	2,200	0.05	0.1	0.079	19,000	1,500	0.04	0.1	0.079			
			10	24,000	1,800	0.035	0.1	0.075	17,000	1,300	0.03	0.1	0.076			
			12	19,000	1,360	0.027	0.1	0.072	14,000	1,000	0.022	0.1	0.071			
			14	18,000	1,200	0.025	0.1	0.067	13,000	900	0.02	0.1	0.069			
			16	18,000	1,150	0.025	0.1	0.064	13,000	850	0.02	0.1	0.065			
			18	17,500	1,120	0.018	0.1	0.064	12,500	800	0.013	0.1	0.064			
			20	17,000	1,080	0.016	0.1	0.064	12,000	780	0.013	0.1	0.064			
			22	17,000	1,080	0.016	0.1	0.064	12,000	780	0.013	0.1	0.064			
			26	16,000	1,000	0.015	0.1	0.063	11,000	700	0.012	0.1	0.064			
			29.8	13,400	840	0.012	0.1	0.063	10,000	620	0.01	0.1	0.062			
			30	13,400	840	0.012	0.1	0.063	10,000	620	0.01	0.1	0.062			
			32	12,000	750	0.011	0.1	0.063	9,000	550	0.009	0.1	0.061			
			36	10,000	620	0.009	0.1	0.062	7,000	420	0.007	0.1	0.06			
			2° or above	2° or above	2° or above	12	19,000	1,632	0.032	0.15	0.086	14,000	1,200	0.026	0.15	0.086
						16	18,000	1,380	0.03	0.15	0.077	13,000	1,020	0.024	0.15	0.078
20	17,000	1,300				0.019	0.15	0.076	12,000	920	0.016	0.15	0.077			
29.8	13,400	1,000				0.014	0.15	0.075	10,000	740	0.012	0.15	0.074			
30	13,400	1,000	0.014	0.15	0.075	10,000	740	0.012	0.15	0.074						

- φ3mm Shank V Series
- UDC-PCD Series
- CBN Series
- Square
- Long Neck Square
- Radius
- Long Neck Radius
- Taper Neck Radius
- Ball / Long Shank Ball
- Long Neck Ball
- Taper Neck Ball
- Taper
- Barrel
- Spiral V Cutter
- Drill
- Technical Data

Milling Conditions for HTNB

WORK MATERIAL				HARDENED STEELS SKD / SKT (45~55HRC)					HARDENED STEELS SKD / SKS (55~65HRC)				
Model Number	Radius of Ball Nose (mm)	Neck Taper Angle	Neck Length (mm)	Spindle Speed (min ⁻¹)	Feed Rate (mm/min)	a_p Axial Depth (mm)	a_e Radial Depth		Spindle Speed (min ⁻¹)	Feed Rate (mm/min)	a_p Axial Depth (mm)	a_e Radial Depth	
							Roughing (mm)	Finishing (mm)				Roughing (mm)	Finishing (mm)
2002	R0.1	1°30' or below	1.5	28,000	330	0.006	0.016	0.012	28,000	260	0.005	0.012	0.009
			2	22,000	210	0.004	0.016	0.01	22,000	190	0.004	0.012	0.009
			3	17,500	150	0.001	0.016	0.009	17,500	130	0.001	0.012	0.007
2003	R0.15	1°30' or below	2	23,500	350	0.006	0.024	0.015	23,500	300	0.005	0.018	0.013
			3	21,500	250	0.003	0.024	0.012	21,500	200	0.002	0.018	0.009
2004	R0.2	1°30' or below	3	27,000	670	0.012	0.032	0.025	27,000	500	0.01	0.024	0.019
			4	22,000	430	0.006	0.032	0.02	22,000	380	0.005	0.024	0.017
			6	18,000	300	0.004	0.032	0.017	18,000	260	0.003	0.024	0.014
2005	R0.25	1°30' or below	4	27,500	650	0.014	0.04	0.024	27,500	625	0.011	0.03	0.023
			6	22,000	530	0.008	0.04	0.024	22,000	500	0.007	0.03	0.023
			8	17,000	380	0.005	0.04	0.022	17,000	350	0.004	0.03	0.021
			10	16,000	330	0.002	0.04	0.021	16,000	300	0.002	0.03	0.019
2006	R0.3	1°30' or below	4	25,500	850	0.022	0.048	0.033	25,500	713	0.018	0.036	0.028
			6	21,000	700	0.012	0.048	0.033	21,000	550	0.01	0.036	0.026
			8	17,000	510	0.012	0.048	0.03	17,000	425	0.01	0.036	0.025
			10	17,000	470	0.009	0.048	0.028	16,000	390	0.008	0.036	0.024
			12	16,000	400	0.006	0.048	0.025	15,000	350	0.005	0.036	0.023
			14	15,500	370	0.004	0.048	0.024	14,500	320	0.004	0.036	0.022
			16	15,000	350	0.003	0.048	0.023	14,500	300	0.003	0.036	0.021
			20	12,000	200	0.001	0.048	0.017	11,000	180	0.001	0.036	0.016
		2° above	8	17,000	610	0.014	0.06	0.036	17,000	510	0.012	0.048	0.03
			12	16,000	480	0.007	0.06	0.03	15,000	420	0.006	0.048	0.028
20	12,000	240	0.001	0.06	0.02	11,000	210	0.001	0.048	0.019			
2008	R0.4	1°30' or below	6	21,000	900	0.016	0.064	0.043	21,000	800	0.013	0.048	0.038
			8	17,000	680	0.016	0.064	0.04	17,000	600	0.013	0.048	0.035
			12	14,000	480	0.012	0.064	0.034	14,000	420	0.01	0.048	0.03
			16	13,000	420	0.006	0.064	0.032	12,500	350	0.006	0.048	0.028
2010	R0.5	1°30' or below	6	23,000	1,500	0.034	0.08	0.065	22,000	1,200	0.028	0.06	0.055
			8	19,000	1,130	0.034	0.08	0.059	18,000	920	0.028	0.06	0.051
			10	16,000	950	0.027	0.08	0.059	15,500	770	0.022	0.06	0.05
			12	12,600	760	0.019	0.08	0.06	12,600	615	0.015	0.06	0.049
			14	12,000	700	0.017	0.08	0.058	12,000	540	0.014	0.06	0.045
			16	12,000	700	0.017	0.08	0.058	12,000	540	0.014	0.06	0.045
			18	11,000	640	0.011	0.08	0.058	11,000	490	0.01	0.06	0.045
			20	11,000	640	0.011	0.08	0.058	11,000	490	0.009	0.06	0.045
			22	11,000	640	0.011	0.08	0.058	11,000	490	0.009	0.06	0.045
			26	10,000	570	0.01	0.08	0.057	10,000	460	0.009	0.06	0.046
			29.8	9,500	530	0.009	0.08	0.055	9,500	410	0.008	0.06	0.043
			30	9,500	530	0.009	0.08	0.055	9,500	410	0.008	0.06	0.043
		32	9,000	490	0.008	0.08	0.054	9,000	380	0.007	0.06	0.042	
		36	7,000	380	0.006	0.08	0.054	7,000	280	0.005	0.06	0.04	
		2° or above	12	12,600	910	0.023	0.1	0.072	12,600	740	0.018	0.08	0.059
			16	12,000	840	0.02	0.1	0.07	12,000	650	0.017	0.08	0.054
20	11,000		770	0.013	0.1	0.07	11,000	590	0.011	0.08	0.054		
29.8	9,500		640	0.011	0.1	0.067	9,500	490	0.01	0.08	0.052		
30	9,500	640	0.011	0.1	0.067	9,500	490	0.01	0.08	0.052			

Ø3mm Shank
V SeriesUDC-PCD
SeriesCBN
SeriesSquare
Long Neck
Square

Radius

Long Neck
RadiusTaper Neck
RadiusBall / Long
Shank BallLong Neck
BallTaper Neck
Ball

Taper

Barrel

Spiral
V Cutter

Drill

Technical Data

Milling Conditions for HTNB

WORK MATERIAL				COPPER / CARBON STEELS Cu / S45C / S50C					PREHARDENED STEELS / HARDENED STEELS NAK / SKD (30~45HRC)							
Model Number	Radius of Ball Nose (mm)	Neck Taper Angle	Neck Length (mm)	Spindle Speed (min ⁻¹)	Feed Rate (mm/min)	a _p Axial Depth (mm)	a _e Radial Depth		Spindle Speed (min ⁻¹)	Feed Rate (mm/min)	a _p Axial Depth (mm)	a _e Radial Depth				
							Roughing (mm)	Finishing (mm)				Roughing (mm)	Finishing (mm)			
2015	R0.75	1°30' or below	10	20,000	2,300	0.065	0.15	0.115	13,000	1,600	0.05	0.15	0.123			
			12	18,000	2,000	0.055	0.15	0.111	13,000	1,500	0.045	0.15	0.115			
			16	16,000	1,600	0.05	0.15	0.1	12,000	1,200	0.03	0.15	0.1			
			20	14,000	1,400	0.035	0.15	0.1	10,000	950	0.025	0.15	0.095			
			22	14,000	1,400	0.035	0.15	0.1	10,000	950	0.025	0.15	0.095			
			26	12,000	1,200	0.025	0.15	0.1	10,000	900	0.02	0.15	0.09			
			30	10,000	950	0.02	0.15	0.095	8,000	700	0.015	0.15	0.088			
		36	10,000	950	0.02	0.15	0.095	7,000	600	0.015	0.15	0.086				
		2° or above	12	18,000	2,400	0.066	0.225	0.133	13,000	1,800	0.054	0.225	0.138			
			16	16,000	1,920	0.06	0.225	0.12	12,000	1,440	0.036	0.225	0.12			
			20	14,000	1,680	0.042	0.225	0.12	10,000	1,140	0.03	0.225	0.114			
			30	10,000	1,140	0.024	0.225	0.114	8,000	840	0.018	0.225	0.105			
			2020	R1	1°30' or below	10	19,000	3,300	0.11	0.2	0.174	12,000	2,100	0.1	0.2	0.175
						12	17,000	2,900	0.09	0.2	0.171	12,000	2,000	0.095	0.2	0.167
16	15,000					2,350	0.081	0.2	0.157	11,000	1,700	0.065	0.2	0.155		
20	11,000	1,600				0.068	0.2	0.145	8,400	1,100	0.055	0.2	0.131			
22	11,000	1,600				0.063	0.2	0.145	8,400	1,050	0.05	0.2	0.125			
24	11,000	1,500				0.063	0.2	0.136	8,400	1,050	0.05	0.2	0.125			
26	10,000	1,350				0.063	0.2	0.135	7,350	900	0.05	0.2	0.122			
28	10,000	1,350				0.05	0.2	0.135	7,350	870	0.038	0.2	0.118			
30	10,000	1,350				0.05	0.2	0.135	7,350	870	0.038	0.2	0.118			
32	10,000	1,350				0.041	0.2	0.135	7,350	850	0.032	0.2	0.116			
34	10,000	1,350				0.041	0.2	0.135	7,000	800	0.032	0.2	0.114			
36	10,000	1,350				0.041	0.2	0.135	7,000	800	0.032	0.2	0.114			
40	10,000	1,350				0.041	0.2	0.135	7,000	800	0.032	0.3	0.114			
2° or above	12	17,000				3,480	0.108	0.3	0.205	12,000	2,400	0.114	0.3	0.2		
	16	15,000	2,820	0.097	0.3	0.188	11,000	2,040	0.078	0.3	0.185					
	20	11,000	1,920	0.082	0.3	0.175	8,400	1,320	0.066	0.3	0.157					
	30	10,000	1,620	0.06	0.3	0.162	7,350	1,040	0.046	0.3	0.141					
	40	10,000	1,620	0.049	0.3	0.135	7,000	960	0.038	0.3	0.135					
	2030	R1.5	1°30' or below	20	11,000	2,350	0.095	0.3	0.214	8,400	1,500	0.075	0.3	0.179		
				22	11,000	2,350	0.09	0.3	0.214	8,400	1,500	0.071	0.3	0.179		
26				10,000	2,050	0.085	0.3	0.205	7,600	1,300	0.068	0.3	0.171			
30				10,000	2,000	0.081	0.3	0.2	7,500	1,250	0.065	0.3	0.167			
32				10,000	1,900	0.081	0.3	0.19	7,500	1,200	0.065	0.3	0.16			
36				9,000	1,700	0.073	0.3	0.189	6,000	950	0.058	0.3	0.158			
40				8,500	1,600	0.065	0.3	0.188	6,000	950	0.053	0.3	0.158			
42				8,500	1,600	0.063	0.3	0.188	6,000	950	0.05	0.3	0.158			
48				8,500	1,570	0.052	0.3	0.185	6,000	920	0.042	0.3	0.153			
52				8,500	1,550	0.045	0.3	0.182	6,000	900	0.036	0.3	0.15			
62				5,600	930	0.035	0.3	0.166	5,000	700	0.025	0.3	0.14			

- φ3mm Shank V Series
- UDC-PCD Series
- CBN Series
- Square
- Long Neck Square
- Radius
- Long Neck Radius
- Taper Neck Radius
- Ball / Long Shank Ball
- Long Neck Ball
- Taper Neck Ball
- Taper
- Barrel
- Spiral V Cutter
- Drill
- Technical Data

Milling Conditions for HTNB

WORK MATERIAL				HARDENED STEELS SKD / SKT (45~55HRC)					HARDENED STEELS SKD / SKS (55~65HRC)							
Model Number	Radius of Ball Nose (mm)	Neck Taper Angle	Neck Length (mm)	Spindle Speed (min ⁻¹)	Feed Rate (mm/min)	a_p Axial Depth (mm)	a_e Radial Depth		Spindle Speed (min ⁻¹)	Feed Rate (mm/min)	a_p Axial Depth (mm)	a_e Radial Depth				
							Roughing (mm)	Finishing (mm)				Roughing (mm)	Finishing (mm)			
2015	R0.75	1°30' or below	10	13,000	1,200	0.04	0.12	0.092	13,000	950	0.035	0.09	0.073			
			12	11,000	950	0.035	0.12	0.086	11,000	750	0.03	0.09	0.068			
			16	11,000	900	0.03	0.12	0.082	11,000	750	0.025	0.09	0.068			
			20	10,000	800	0.02	0.12	0.08	10,000	650	0.018	0.09	0.065			
			22	10,000	800	0.02	0.12	0.08	10,000	650	0.018	0.09	0.065			
			26	9,000	700	0.017	0.12	0.078	9,000	600	0.015	0.09	0.067			
			30	8,000	600	0.013	0.12	0.075	8,000	500	0.013	0.09	0.063			
			36	7,000	500	0.013	0.12	0.071	7,000	400	0.013	0.09	0.057			
		2° or above	12	11,000	1,140	0.042	0.15	0.104	11,000	900	0.036	0.12	0.082			
			16	11,000	1,080	0.036	0.15	0.098	11,000	900	0.03	0.12	0.082			
			20	10,000	960	0.024	0.15	0.096	10,000	780	0.022	0.12	0.078			
			30	8,000	720	0.016	0.15	0.09	8,000	600	0.016	0.12	0.075			
			2020	R1	1°30' or below	10	12,000	1,800	0.074	0.16	0.15	12,000	1,350	0.064	0.12	0.113
						12	10,500	1,430	0.065	0.16	0.136	10,500	1,070	0.055	0.12	0.102
16	10,500	1,360				0.056	0.16	0.13	10,500	1,070	0.046	0.12	0.102			
20	9,450	1,150				0.048	0.16	0.122	9,450	920	0.038	0.12	0.097			
22	9,450	1,150				0.043	0.16	0.122	9,450	920	0.036	0.12	0.097			
24	8,400	1,020				0.043	0.16	0.121	8,400	800	0.036	0.12	0.095			
26	8,400	1,020				0.043	0.16	0.121	8,400	800	0.036	0.12	0.095			
28	7,350	850				0.033	0.16	0.116	7,350	690	0.028	0.12	0.094			
30	7,350	850				0.033	0.16	0.116	7,350	690	0.028	0.12	0.094			
32	7,350	850				0.028	0.16	0.116	7,350	690	0.023	0.12	0.094			
34	6,500	745				0.028	0.16	0.115	6,500	610	0.023	0.12	0.094			
36	6,500	745				0.028	0.16	0.115	6,500	610	0.023	0.12	0.094			
40	6,500	745			0.028	0.16	0.115	6,500	610	0.023	0.12	0.094				
2° or above	12	10,500			1,720	0.078	0.2	0.164	10,500	1,280	0.066	0.16	0.122			
	16	10,500	1,630	0.067	0.2	0.155	10,500	1,280	0.055	0.16	0.122					
	20	9,450	1,380	0.058	0.2	0.146	9,450	1,100	0.046	0.16	0.117					
	30	7,350	1,020	0.04	0.2	0.139	7,350	830	0.034	0.16	0.113					
2030	R1.5	1°30' or below	20	8,000	1,400	0.065	0.24	0.175	8,000	1,200	0.053	0.18	0.15			
			22	8,000	1,400	0.062	0.24	0.175	8,000	1,200	0.05	0.18	0.15			
			26	7,500	1,200	0.06	0.24	0.16	7,500	1,050	0.048	0.18	0.14			
			30	7,000	1,100	0.057	0.24	0.157	7,000	980	0.047	0.18	0.14			
			32	7,000	1,100	0.056	0.24	0.157	7,000	950	0.046	0.18	0.136			
			36	6,000	950	0.05	0.24	0.158	6,000	800	0.042	0.18	0.133			
			40	5,500	850	0.045	0.24	0.155	5,500	750	0.038	0.18	0.136			
			42	5,500	850	0.043	0.24	0.155	5,500	750	0.036	0.18	0.136			
			48	5,500	820	0.035	0.24	0.149	5,500	720	0.03	0.18	0.131			
			52	5,500	800	0.031	0.24	0.145	5,500	700	0.026	0.18	0.127			
			62	4,700	600	0.023	0.24	0.128	4,700	530	0.021	0.18	0.113			

Ø3mm Shank
V SeriesUDC-PCD
SeriesCBN
Series

Square

Square

Long Neck
Square

Radius

Radius

Long Neck
RadiusTaper Neck
RadiusBall / Long
Shank Ball

Ball

Long Neck
BallTaper Neck
Ball

Taper

Taper

Barrel

Spiral
V Cutter

Drill

Technical Data

Milling Conditions for HTNB

WORK MATERIAL				COPPER / CARBON STEELS Cu / S45C / S50C					PREHARDENED STEELS / HARDENED STEELS NAK / SKD (30~45HRC)				
Model Number	Radius of Ball Nose (mm)	Neck Taper Angle	Neck Length (mm)	Spindle Speed (min ⁻¹)	Feed Rate (mm/min)	a _p Axial Depth (mm)	a _e Radial Depth		Spindle Speed (min ⁻¹)	Feed Rate (mm/min)	a _p Axial Depth (mm)	a _e Radial Depth	
							Roughing (mm)	Finishing (mm)				Roughing (mm)	Finishing (mm)
2040	R2	1°30' or below	20	8,400	1,900	0.125	0.4	0.226	5,400	1,030	0.096	0.4	0.191
			30	7,600	1,600	0.1	0.4	0.211	4,800	850	0.083	0.4	0.177
			36	6,900	1,400	0.094	0.4	0.203	3,900	650	0.074	0.4	0.167
			40	6,500	1,300	0.086	0.4	0.2	3,900	650	0.068	0.4	0.167
			41	6,500	1,300	0.086	0.4	0.2	3,900	650	0.068	0.4	0.167
			60	4,300	780	0.063	0.4	0.181	3,300	500	0.05	0.4	0.152
			62	4,300	750	0.063	0.4	0.174	3,300	480	0.05	0.4	0.145
			80	4,300	750	0.063	0.4	0.174	3,300	480	0.05	0.4	0.145
Radial Depth (mm)			Roughing	Neck Taper Angle 1°30' or below a _e ≤ 0.1D. Neck Taper Angle 2° or above a _e ≤ 0.15D.					Neck Taper Angle 1°30' or below a _e ≤ 0.1D. Neck Taper Angle 2° or above a _e ≤ 0.15D.				
			Finishing	$a_e \leq Vf / n$									

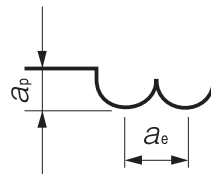

D : Outside Diameter (mm)
 n : Spindle Speed
 Vf : Feed Rate

- φ3mm Shank V Series
- UDC-PCD Series
- CBN Series
- Square
- Long Neck Square
- Radius
- Long Neck Radius
- Taper Neck Radius
- Ball / Long Shank Ball
- Long Neck Ball
- Taper Neck Ball
- Taper
- Barrel
- Spiral V Cutter
- Drill
- Technical Data

Milling Conditions for HTNB

WORK MATERIAL			HARDENED STEELS SKD / SKT (45~55HRC)						HARDENED STEELS SKD / SKS (55~65HRC)				
Model Number	Radius of Ball Nose (mm)	Neck Taper Angle	Neck Length (mm)	Spindle Speed (min ⁻¹)	Feed Rate (mm/min)	a_p Axial Depth (mm)	a_e Radial Depth		Spindle Speed (min ⁻¹)	Feed Rate (mm/min)	a_p Axial Depth (mm)	a_e Radial Depth	
							Roughing (mm)	Finishing (mm)				Roughing (mm)	Finishing (mm)
2040	R2	1°30' or below	20	5,200	980	0.085	0.32	0.188	5,200	840	0.066	0.24	0.162
			30	4,500	770	0.074	0.32	0.171	4,500	690	0.059	0.24	0.153
			36	3,900	670	0.065	0.32	0.172	3,900	560	0.052	0.24	0.144
			40	3,600	600	0.059	0.32	0.167	3,600	530	0.048	0.24	0.147
			41	3,600	600	0.059	0.32	0.167	3,600	530	0.048	0.24	0.147
			60	3,100	450	0.043	0.32	0.145	3,100	400	0.036	0.24	0.129
			62	3,100	420	0.043	0.32	0.135	3,100	380	0.036	0.24	0.123
			80	2,900	340	0.035	0.32	0.117	2,500	200	0.02	0.24	0.08
Radial Depth (mm)			Roughing	Neck Taper Angle 1°30' or below $a_e \leq 0.08D$. Neck Taper Angle 2° or above $a_e \leq 0.1D$.					Neck Taper Angle 1°30' or below $a_e \leq 0.06D$. Neck Taper Angle 2° or above $a_e \leq 0.08D$.				
			Finishing	$a_e \leq Vf / n$									

Note:

- Decrease both spindle speed and feed rate proportionally when the milling parameters exceed the machine's maximum spindle speed.
- The neck length and taper angle may affect the milling parameters. In operation, fine adjustments may be required.
- Recommend air blow or oil mist.
- Recommend oil coolant for Stainless Steels and Heat Resistant Alloys.
- Recommend water soluble or oil base coolant for Copper.

Ø3mm Shank
V SeriesUDC-PCD
SeriesCBN
Series

Square

Long Neck
Square

Radius

Long Neck
RadiusTaper Neck
RadiusBall / Long
Shank BallLong Neck
BallTaper Neck
Ball

Taper

Barrel

Spiral
V Cutter

Drill

Technical Data



Size R0.5~R1

DCTNB

MG DIA 35° R ±0.01 Shank Dia 0/-0.005

Material Applications (★ Highly Recommended ● Recommended ○ Suggested)

Work Material																	
Carbon Steels S45C S55C	Alloy Steels SK / SCM SUS	Prehardened Steels NAK HPM	Hardened Steels					Cast Iron	Aluminum Alloys	Graphite	Copper	Plastics	Glass Filled Plastics	Titanium Alloys	Heat Resistant Alloys	Cemented Carbide	Hard Brittle (Non-Metallic) Materials
			~50HRC	~55HRC	~60HRC	~65HRC	~70HRC										
									○	★	○	○	●				○

Features

2 Flute Diamond coated Taper Neck Ball End Mills for Graphite Electrodes.
Taper Neck design improves the tool rigidity and provides high-efficiency & high-precision milling.
Original and optimized Diamond coating offers outstanding resistance to wear on Graphite.
Excellent adhesion coating with long-life tool design.

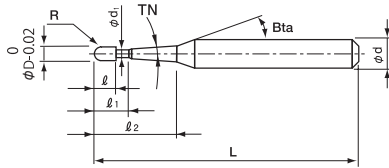
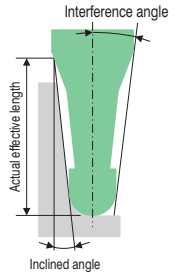

The shank taper angle shown is not an exact value and to avoid contact with the work piece, we recommend the user controls the precise value of this angle. Shank taper angle should not make contact with the work piece.

Total 15 models

Unit (mm)

Model Number	Radius of Ball Nose R	Neck Taper Angle TN	Neck Length ℓ ₂	Effective Length ℓ ₁	Length of Cut ℓ	Neck Diameter φ _{d1}	Shank Taper Angle Bta	Overall Length L	Shank Diameter φ _d	Suggested Retail Price ¥	Interference Angle	Effective Length by Inclined Angles — : Interference				
												30'	1°	1°30'	2°	3°
DCTNB 2010-200-1.8	R0.5	0.9°	20	4	0.8	0.96	16°	80	6	18,730	5.25°	—	20.24	20.90	21.61	23.20
DCTNB 2010-250-1.8			25					80	6	21,850	4.48°	—	25.27	26.10	26.99	28.98
DCTNB 2010-400-1.8			40					100	6	25,470	3.11°	—	40.36	41.70	43.13	46.32
DCTNB 2010-600-1.8			60					120	6	33,220	2.21°	—	60.49	62.50	64.65	No Interference
DCTNB 2010-700-1.8			70					120	6	33,220	1.93°	—	70.55	72.90	No Interference	No Interference
DCTNB 2010-800-1.8			80					140	6	33,490	1.72°	—	80.62	83.30	No Interference	No Interference
DCTNB 2010-900-1.8			90					150	6	35,230	1.54°	—	90.68	93.71	No Interference	No Interference
DCTNB 2020-200-1.8	R1	0.9°	20	7	1.6	1.9	16°	80	6	18,730	4.55°	—	20.34	21.00	21.69	23.25
DCTNB 2020-250-1.8			25					80	6	21,850	3.84°	—	25.38	26.20	27.08	29.03
DCTNB 2020-400-1.8			40					100	6	25,470	2.61°	—	40.47	41.80	43.22	No Interference
DCTNB 2020-450-1.8			45					100	6	25,470	2.36°	—	45.51	47.00	48.60	No Interference
DCTNB 2020-600-1.8			60					120	6	33,220	1.83°	—	60.59	62.59	No Interference	No Interference
DCTNB 2020-700-1.8			70					120	6	33,220	1.59°	—	70.66	73.00	No Interference	No Interference
DCTNB 2020-800-1.8			80					140	6	33,490	1.41°	—	80.72	No Interference	No Interference	No Interference
DCTNB 2020-1000-1.8			100					150	6	37,910	1.15°	—	100.85	No Interference	No Interference	No Interference

Milling Conditions for DCTNB

WORK MATERIAL			GRAPHITE			
Model Number	Radius of Ball Nose (mm)	Neck Length (mm)	Spindle Speed (min ⁻¹)	Feed Rate (mm/min)	a_p Axial Depth (mm)	a_e Radial Depth (mm)
2010-200-1.8	R0.5	20	30,000	1,500	0.1	0.12
2010-250-1.8		25	30,000	1,500	0.08	0.12
2010-400-1.8		40	27,000	1,200	0.07	0.12
2010-600-1.8		60	23,000	800	0.06	0.12
2010-700-1.8		70	20,000	600	0.05	0.12
2010-800-1.8		80	18,000	500	0.04	0.12
2010-900-1.8		90	15,000	400	0.03	0.12
2020-200-1.8	R1	20	27,000	2,000	0.24	0.5
2020-250-1.8		25	27,000	2,000	0.19	0.5
2020-400-1.8		40	27,000	2,000	0.13	0.4
2020-450-1.8		45	27,000	2,000	0.11	0.4
2020-600-1.8		60	23,000	1,500	0.1	0.3
2020-700-1.8		70	20,000	1,200	0.09	0.3
2020-800-1.8		80	17,000	900	0.09	0.2
2020-10001.8		100	14,000	600	0.09	0.2

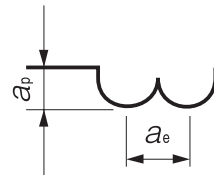

Note:

- Use a milling machine dedicated for Graphite.
- Decrease the feed rate more than 50% from the milling parameters when slot milling.
- Recommend air blow for Graphite.

Other series for Graphite milling

Square / Long Neck Square

(★ Highly Recommended ● Recommended ○ Suggested)

Number of Flutes, Tool Type	Model Number	Appearance	Coating	Size	Aluminum Alloys	Graphite	Copper	Plastics	Glass Filled Plastics	Hard Brittle (Non-Metallic) Materials	Page
4 flutes Square	CGE		Non-coat	$\phi 2 \sim \phi 20$	○	★	○	○	○		236
2 flutes Square	DCES 2000		DIA	$\phi 0.2 \sim \phi 6$	○	★	○	○	●	○	188
4 flutes Square	DCES 4000		DIA	$\phi 3 \sim \phi 10$	○	★	○	○	●	○	234
2 flutes Long Neck Square	DCLS		DIA	$\phi 0.4 \sim \phi 6$	○	★	○	○	●	○	266

Long Neck Radius

4 flutes Long Neck Radius	DCLRS		DIA	$\phi 1 \sim \phi 6$	○	★	○	○	●	○	396
---------------------------	--------------	--	-----	----------------------	---	---	---	---	---	---	-----

Ball / Long Neck Ball / Taper Neck Ball

2 flutes Ball	CGB 2000		Non-coat	R0.2 ~ R6	○	★	○	○	○		440
4 flutes Ball	CGB 4000		Non-coat	R2 ~ R10	○	★	○	○	○		458
2 flutes Ball	DCB		DIA	R0.5 ~ R6	○	★	○	○	●	○	438
2 flutes Long Neck Ball	DCLB		DIA	R0.2 ~ R3	○	★	○	○	●	○	512
2 flutes Taper Neck Ball	DCTNB		DIA	R0.5 ~ R1	○	★	○	○	●	○	556

3mm Shank V Series

UDC-PCD Series

CBN Series

Square

Square

Long Neck Square

Radius

Radius

Long Neck Radius

Taper Neck Radius

Ball

Ball / Long Shank Ball

Ball

Long Neck Ball

Taper Neck Ball

Taper

Taper

Barrel

Spiral V Cutter

Drill

Technical Data



Size R0.5~R2

HFTNB



R0.5~R1.5

R2

Material Applications (★ Highly Recommended ● Recommended ○ Suggested)

Work Material																	
Carbon Steels S45C S55C	Alloy Steels SK / SCM SUS	Prehardened Steels NAK HPM	Hardened Steels					Cast Iron	Aluminum Alloys	Graphite	Copper	Plastics	Glass Filled Plastics	Titanium Alloys	Heat Resistant Alloys	Cemented Carbide	Hard Brittle (Non-Metallic) Materials
			~50HRC	~55HRC	~60HRC	~65HRC	~70HRC										
○	○	●	●	●	●	●		○						○	○		

Features

3 Flute Taper Neck Ball End Mills for Hard Materials.

The negative rake angle design improves wear resistance.

Back taper design reduces cutting resistance.

Suitable for both roughing and finishing. Diameter Tolerance : 0/-0.015.

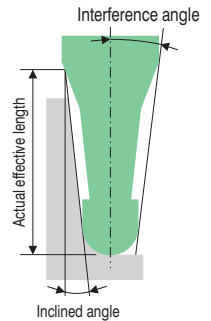

Shape A

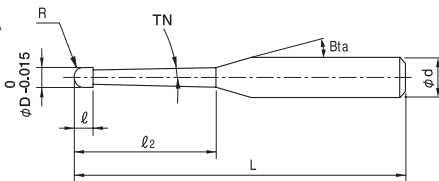

Shape B

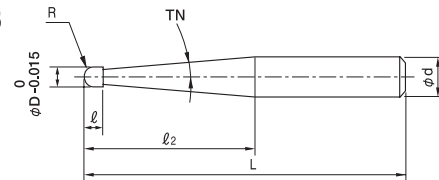

The shank taper angle shown is not an exact value and to avoid contact with the work piece, we recommend the user controls the precise value of this angle. Shank taper angle should not make contact with the work piece.

- **Variable Pitch design**
Minimizing vibration and chattering



※ Variable Pitch $\alpha \neq \beta \neq \gamma$

- **A wide choice of Taper Neck Angles**

Useful sizes: 0.4° · 0.9° · 1.4° · 1.9° · 2.9°

Using with HTNRS, Taper Neck Radius End Mill, offers higher efficient milling.

Refer to page 412 for HTNRS.

Total 75 models

Unit (mm)

Model Number	Radius of Ball Nose R	Neck Taper Angle TN	Neck Length ℓ_2	Length of Cut ℓ	Shank Taper Angle Bta	Overall Length L	Shank Diameter ϕd	Shape	Suggested Retail Price ¥	Interference Angle	Effective Length by Inclined Angles — : Interference					
											30'	1°	1°30'	2°	3°	
											HFTNB 3010-080-08	RO.5	0.4°	8	0.8	16°
HFTNB 3010-100-08	10	60	6	8,690	7.89°	10.07	10.38	10.71	11.07	11.87						
HFTNB 3010-120-08	12	60	6	8,690	7.13°	12.08	12.46	12.86	13.29	14.26						
HFTNB 3010-160-08	16	60	6	8,690	5.98°	16.10	16.61	17.16	17.74	19.03						
HFTNB 3010-200-08	20	60	6	11,040	5.15°	20.13	20.77	21.45	22.18	23.81						
HFTNB 3010-260-08	26	70	6	11,590	4.26°	26.17	27.00	27.89	28.85	30.97						
HFTNB 3010-300-08	30	70	6	12,140	3.82°	30.19	31.16	32.19	33.29	35.75						
HFTNB 3010-060-18	0.9°	6	60	6	8,690	10.11°	—	6.06	6.25	6.45	6.90					
HFTNB 3010-080-18		8	60	6	8,690	8.94°	—	8.07	8.33	8.60	9.21					
HFTNB 3010-100-18		10	60	6	8,690	8.01°	—	10.08	10.41	10.75	11.53					
HFTNB 3010-120-18		12	60	6	8,690	7.25°	—	12.10	12.49	12.91	13.84					
HFTNB 3010-160-18		16	60	6	8,690	6.10°	—	16.12	16.65	17.21	18.47					
HFTNB 3010-200-18		20	60	6	11,040	5.26°	—	20.15	20.81	21.52	23.09					
HFTNB 3010-260-18		26	70	6	11,590	4.36°	—	26.19	27.05	27.98	30.03					
HFTNB 3010-300-18		30	70	6	12,140	3.91°	—	30.21	31.21	32.28	34.66					
HFTNB 3010-100-28		1.4°	10	60	6	8,690	8.13°	—	—	10.10	10.43		11.18			
HFTNB 3010-120-28	12		60	6	8,690	7.38°	—	—	12.11	12.52	13.42					
HFTNB 3010-160-28	16		60	6	8,690	6.22°	—	—	16.14	16.68	17.90					
HFTNB 3010-200-28	20		60	6	11,040	5.37°	—	—	20.17	20.85	22.38					
HFTNB 3010-260-28	26		70	6	11,590	4.46°	—	—	26.21	27.10	29.09					
HFTNB 3015-100-08	RO.75		0.4°	10	1.2	16°	60	6	A	9,110	7.55°	10.11	10.41	10.74	11.09	11.87
HFTNB 3015-160-08		16		60			6	9,940		5.64°	16.14	16.65	17.18	17.75	19.03	
HFTNB 3015-200-08		20		60			6	9,940		4.82°	20.17	20.80	21.48	22.20	23.81	
HFTNB 3015-300-08		30		70			6	10,760		3.54°	30.23	31.19	32.21	33.31	35.75	
HFTNB 3015-100-18		0.9°	10	60			6	9,110		7.66°	—	10.13	10.45	10.79	11.54	
HFTNB 3015-160-18			16	60			6	9,940		5.75°	—	16.17	16.69	17.24	18.48	
HFTNB 3015-200-18			20	60			6	9,940		4.93°	—	20.19	20.85	21.55	23.11	
HFTNB 3015-300-18			30	70			6	10,760		3.63°	—	30.26	31.25	32.31	34.67	
HFTNB 3015-100-28		1.4°	10	60			6	9,110		7.79°	—	—	10.15	10.48	11.21	
HFTNB 3015-160-28			16	60			6	9,940		5.87°	—	—	16.19	16.73	17.93	
HFTNB 3015-200-28			20	60			6	9,940		5.03°	—	—	20.22	20.90	22.41	
HFTNB 3015-300-28			30	80			6	10,760		3.72°	—	—	30.28	31.31	33.60	

Next Page ➡

3 Flutes

Ø3mm Shank V Series

UDC-PCD Series

CBN Series

Square

Long Neck Square

Radius

Long Neck Radius

Taper Neck Radius

Ball / Long Shank Ball

Long Neck Ball

Taper Neck Ball

Taper

Barrel

Spiral V Cutter

Drill

Technical Data

Model Number	Radius of Ball Nose R	Neck Taper Angle TN	Neck Length ℓ_2	Length of Cut ℓ	Shank Taper Angle Bta	Overall Length L	Shank Diameter ϕd	Shape	Suggested Retail Price ¥	Interference Angle	Effective Length by Inclined Angles - : Interference						
											30'	1°	1°30'	2°	3°		
HFTNB 3020-120-08	R1	0.4°	12	1.6	16°	60	6	A	9,100	6.40°	12.12	12.49	12.87	13.29	14.22		
HFTNB 3020-160-08			16						9,320	5.27°	16.15	16.64	17.17	17.73	18.99		
HFTNB 3020-200-08			20						9,940	4.47°	20.17	20.80	21.46	22.18	23.77		
HFTNB 3020-220-08			22						9,940	4.16°	22.18	22.87	23.61	24.40	26.16		
HFTNB 3020-260-08			26						11,040	3.65°	26.21	27.03	27.90	28.84	30.93		
HFTNB 3020-300-08			30						12,140	3.25°	30.23	31.18	32.20	33.29	35.71		
HFTNB 3020-320-08			32						12,140	3.08°	32.25	33.26	34.35	35.51	38.09		
HFTNB 3020-360-08			36						12,140	2.79°	36.26	37.40	38.63	39.94	No Interference		
HFTNB 3020-400-08			40						14,350	2.55°	40.30	41.57	42.94	44.40	No Interference		
HFTNB 3020-120-18			0.9°						12	60	6	9,100	6.52°	—	12.15	12.52	12.93
HFTNB 3020-160-18		16		60	6	9,320	5.38°	—	16.17	16.68	17.23	18.46					
HFTNB 3020-200-18		20		60	6	9,940	4.57°	—	20.20	20.85	21.54	23.08					
HFTNB 3020-260-18		26		70	6	11,040	3.74°	—	26.24	27.09	28.00	30.02					
HFTNB 3020-300-18		30		70	6	12,140	3.33°	—	30.26	31.25	32.30	34.65					
HFTNB 3020-360-18		36		80	6	12,140	2.86°	—	36.30	37.49	38.76	No Interference					
HFTNB 3020-400-18		40		80	6	14,350	2.62°	—	40.33	41.65	43.06	No Interference					
HFTNB 3020-500-18		50		100	6	16,000	2.16°	—	50.39	52.05	53.83	No Interference					
HFTNB 3020-160-28		1.4°		16	60	6	9,320	5.49°	—	—	16.20	16.73	17.92				
HFTNB 3020-200-28				20	60	6	9,940	4.68°	—	—	20.23	20.90	22.40				
HFTNB 3020-260-28			26	70	6	11,040	3.83°	—	—	26.27	27.15	29.11					
HFTNB 3020-300-28	30		70	6	12,140	3.41°	—	—	30.30	31.32	33.59						
HFTNB 3020-400-28	40		80	6	15,070	2.69°	—	—	40.36	41.73	No Interference						
HFTNB 3020-620-38	1.9°	62	—	100	6	B	18,000	—	—	—	No Interference	No Interference					
HFTNB 3020-410-58	2.9°	41	—	80	6	B	17,000	—	—	—	—	No Interference					
HFTNB 3030-200-08	R1.5	0.4°	20	2.4	16°	60	6	A	11,200	3.67°	20.23	20.84	21.49	22.19	23.75		
HFTNB 3030-260-08			26						70	6	11,960	2.94°	26.27	27.07	27.93	28.86	No Interference
HFTNB 3030-300-08			30						70	6	13,660	2.60°	30.29	31.23	32.23	33.30	No Interference
HFTNB 3030-320-08			32						80	6	14,350	2.46°	32.31	33.31	34.38	35.52	No Interference
HFTNB 3030-360-08			36						80	6	14,950	2.21°	36.31	37.45	38.65	39.95	No Interference
HFTNB 3030-400-08			40						80	6	15,180	2.01°	40.36	41.62	42.97	44.41	No Interference
HFTNB 3030-200-18		0.9°	20			60	6	11,200	3.76°	—	20.27	20.90	21.58	23.09			
HFTNB 3030-300-18			30			70	6	13,660	2.67°	—	30.34	31.31	32.34	No Interference			
HFTNB 3030-400-18			40			80	6	15,180	2.07°	—	40.40	41.71	43.11	No Interference			
HFTNB 3030-500-18			50			100	6	17,500	1.69°	—	50.46	52.11	No Interference	No Interference			
HFTNB 3030-600-18			60			100	6	19,000	1.43°	—	60.52	No Interference	No Interference	No Interference			
HFTNB 3030-400-28			40			80	6	15,180	2.12°	—	—	40.45	41.80	No Interference			
HFTNB 3030-500-28		1.4°	50			100	6	17,000	1.74°	—	—	50.51	No Interference	No Interference			
HFTNB 3030-650-28			65			—	100	6	B	19,000	—	—	—	No Interference	No Interference		
HFTNB 3040-300-18			R2			0.9°	30	6	16°	80	6	A	13,330	1.90°	—	30.51	31.47
HFTNB 3040-400-18	40	80		6	17,250		1.45°						—	40.58	No Interference	No Interference	No Interference
HFTNB 3040-500-18	50	100		6	19,000		1.18°						—	50.64	No Interference	No Interference	No Interference
HFTNB 3040-600-18	60	100		6	20,200		0.99°						—	No Interference	No Interference	No Interference	No Interference
HFTNB 3040-480-28	1.4°	48		—	80		6						B	17,250	—	—	—

φ3mm Shank V Series

UDC-PCD Series

CBN Series

Square Long Neck Square

Radius

Long Neck Radius

Taper Neck Radius

Ball / Long Shank Ball Long Neck Ball Taper Neck Ball

Taper

Barrel

Spiral V Cutter

Drill

Technical Data

Milling Conditions for HFTNB

WORK MATERIAL			PREHARDENED STEELS / HARDENED STEELS NAK / SKD (30~45HRC)				HARDENED STEELS SKD / SKT (45~55HRC)				HARDENED STEELS SKD / SKH (55~65HRC)			
Model Number	Radius of Ball Nose (mm)	Neck Length (mm)	Spindle Speed (min ⁻¹)	Feed Rate (mm/min)	a _p Axial Depth (mm)	a _e Radial Depth (mm)	Spindle Speed (min ⁻¹)	Feed Rate (mm/min)	a _p Axial Depth (mm)	a _e Radial Depth (mm)	Spindle Speed (min ⁻¹)	Feed Rate (mm/min)	a _p Axial Depth (mm)	a _e Radial Depth (mm)
3010	R0.5	6	14,500	1,300	0.1	0.2	14,500	1,250	0.06	0.12	14,500	1,200	0.04	0.08
		8	14,000	1,200	0.09	0.18	13,750	1,160	0.06	0.1	13,500	1,120	0.04	0.06
		10	13,300	1,000	0.08	0.16	12,650	1,000	0.05	0.09	12,000	1,000	0.04	0.05
		12	13,000	870	0.07	0.14	12,000	850	0.04	0.08	11,000	880	0.03	0.05
		16	12,500	680	0.05	0.1	10,250	600	0.04	0.06	8,000	550	0.03	0.04
		20	12,000	600	0.04	0.08	9,500	500	0.03	0.06	7,000	400	0.02	0.04
		26	11,700	520	0.03	0.06	8,600	370	0.02	0.04	5,500	220	0.02	0.03
		30	11,500	500	0.02	0.05	8,250	350	0.02	0.04	5,000	200	0.02	0.03
3015	R0.75	10	12,000	1,230	0.13	0.3	11,500	1,100	0.09	0.2	11,000	1,100	0.06	0.14
		16	11,200	930	0.1	0.25	10,600	910	0.07	0.16	10,000	900	0.05	0.11
		20	10,800	750	0.08	0.22	9,500	700	0.06	0.14	8,200	680	0.04	0.09
		30	10,000	550	0.06	0.16	8,300	450	0.04	0.1	6,600	380	0.03	0.08
3020	R1	12	10,300	1,200	0.16	0.38	10,150	1,130	0.12	0.25	10,000	1,100	0.1	0.18
		16	10,000	1,100	0.15	0.35	9,900	1,100	0.1	0.23	9,800	1,050	0.09	0.16
		20	9,500	950	0.15	0.32	9,300	940	0.1	0.21	9,000	930	0.08	0.15
		22	9,400	900	0.14	0.3	9,100	850	0.09	0.2	8,600	840	0.08	0.14
		26	9,300	750	0.12	0.28	8,700	730	0.08	0.2	8,000	700	0.07	0.13
		30	9,200	630	0.11	0.25	8,400	590	0.08	0.17	7,500	550	0.05	0.1
		32	8,800	580	0.1	0.24	8,200	550	0.07	0.16	7,300	480	0.04	0.1
		36	8,700	570	0.09	0.22	7,900	510	0.07	0.16	7,000	450	0.04	0.1
		40	8,300	500	0.08	0.2	7,500	450	0.06	0.15	6,600	400	0.04	0.1
		41	8,300	500	0.08	0.2	7,500	450	0.06	0.15	6,600	400	0.04	0.1
		50	8,000	430	0.06	0.15	6,700	340	0.04	0.12	5,300	250	0.03	0.1
		62	7,500	350	0.04	0.1	6,000	350	0.04	0.13	5,000	300	0.02	0.05
3030	R1.5	20	9,000	1,150	0.25	0.48	8,900	1,100	0.18	0.36	8,800	1,100	0.12	0.25
		26	8,600	1,000	0.22	0.42	8,300	1,000	0.16	0.32	8,200	980	0.11	0.22
		30	8,400	950	0.21	0.4	8,100	930	0.15	0.3	7,800	920	0.1	0.21
		32	8,300	900	0.2	0.37	7,800	860	0.14	0.28	7,400	840	0.09	0.2
		36	8,100	800	0.18	0.35	7,400	720	0.13	0.26	6,800	680	0.08	0.2
		40	8,000	720	0.17	0.33	7,000	630	0.12	0.24	6,000	550	0.08	0.19
		50	7,600	570	0.14	0.28	6,400	450	0.09	0.2	5,200	400	0.06	0.17
		60	7,200	480	0.12	0.24	6,000	400	0.07	0.18	4,700	320	0.05	0.16
		65	7,200	480	0.12	0.24	6,000	400	0.07	0.18	4,700	320	0.05	0.16

- Ø3mm Shank V Series
- UDC-PCD Series
- CBN Series
- Square
- Long Neck Square
- Radius
- Long Neck Radius
- Taper Neck Radius
- Ball
- Ball / Long Shank Ball
- Long Neck Ball
- Taper Neck Ball
- Taper
- Barrel
- Spiral V Cutter
- Drill
- Technical Data

Milling Conditions for HFTNB

WORK MATERIAL			PREHARDENED STEELS / HARDENED STEELS NAK / SKD (30~45HRC)				HARDENED STEELS SKD / SKT (45~55HRC)				HARDENED STEELS SKD / SKH (55~65HRC)			
Model Number	Radius of Ball Nose (mm)	Neck Length (mm)	Spindle Speed (min ⁻¹)	Feed Rate (mm/min)	a_p Axial Depth (mm)	a_e Radial Depth (mm)	Spindle Speed (min ⁻¹)	Feed Rate (mm/min)	a_p Axial Depth (mm)	a_e Radial Depth (mm)	Spindle Speed (min ⁻¹)	Feed Rate (mm/min)	a_p Axial Depth (mm)	a_e Radial Depth (mm)
3040	R2	30	8,000	1,100	0.35	0.55	7,800	1,050	0.24	0.4	7,600	1,000	0.16	0.33
		40	7,500	930	0.3	0.48	7,300	900	0.2	0.35	7,000	900	0.15	0.3
		48	7,200	750	0.26	0.42	6,500	650	0.16	0.3	5,800	600	0.13	0.27
		50	7,200	750	0.26	0.42	6,500	650	0.16	0.3	5,800	600	0.13	0.27
		60	7,000	600	0.22	0.36	6,000	520	0.13	0.26	5,000	440	0.11	0.25

Note:

- Decrease both spindle speed and feed rate proportionally when the milling parameters exceed the machine's maximum spindle speed.
- Decrease the feed rate more than 50% from the milling parameters when slot milling.
- Every coolant offers stable milling.

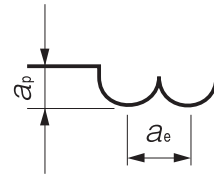

Roughness Comparison

HFTNB R1 × Neck Length 20 × Neck Taper Angle 0.4° SKD61 (48HRC)



Work Size : 30 x 50 x 40 mm

Measurement Spot	Surface Roughness Ra (μm)	
	HFTNB	Competitor
①	0.353	0.451
②	0.480	0.865
③	0.200	0.270
④	0.168	0.248

Better surface roughness compared to competitor's!

No.	Milling Process	Tool	Spindle Speed (min ⁻¹)	Feed Rate (mm/min)	a_p (mm)	a_e (mm)	Allowance (mm)	Coolant	Cycle Time (h:m:s)
1	Roughing	HSLB 2060-200 (R3 x EL20)	13,000	3,500	0.6	0.6	0.05		0:25:33
2	Semi-finishing	HSLB 2030-200 (R1.5 x EL20)	14,500	1,360	0.18	0.1	0.02	Air Blow	0:49:48
3	Finishing	HFTNB 3020-200-08 / Competitor (R1 x Neck Length 20 x Neck Taper Angle 0.4°)	4,650	940	0.05	0.05	0		2:29:29

Total 3:44:50

Taper Pocket Milling Examples

HFTNB R1 × Neck Length 30 × Neck Taper Angle 0.9°

SKD61 (50HRC)

3 Flutes

Milling Shape : Taper Pocket 25 x 5 x Depth 4 mm Wall Inclined Angle 1°

Tools after milling

HFTNB

After 40 min

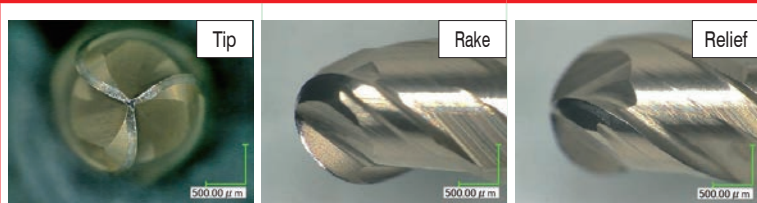

After 120 min

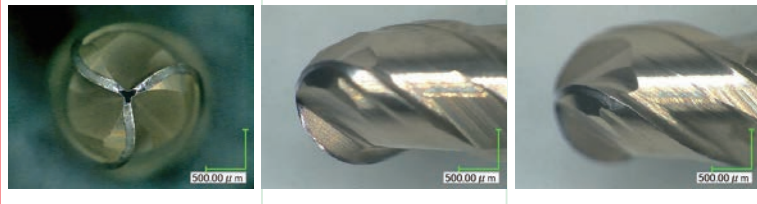

Normal wear condition after 120 min milling. No chipping or any damages.

Competitor A
After 40 min



Chipping on the cutting edges of all 3 flutes after 40 min.

Competitor B
After 40 min



Large chipping on the cutting edge after 40 min. Chipping also on the other 2 flutes.

High durability throughout the long cycle time.

Tool	Spindle Speed (min ⁻¹)	Feed Rate (mm/min)	a_p (mm)	a_e (mm)	Coolant	Cycle Time
HFTNB 3020-300-18	8,400	590	0.08	0.17	Air Blow	40 min / pocket

- 3mm Shank V Series
- UDC-PCD Series
- CBN Series
- Square
- Long Neck Square
- Radius
- Long Neck Radius
- Taper Neck Radius
- Ball / Long Shank Ball
- Long Neck Ball
- Taper Neck Ball
- Taper
- Barrel
- Spiral V Cutter
- Drill
- Technical Data



Size $\phi 0.2 \sim \phi 2.5$

C-CTE2000



$\phi 0.2 \sim \phi 0.4$ $\phi 0.5 \sim \phi 2.5$

Material Applications (★ Highly Recommended ● Recommended ○ Suggested)

Work Material																	
Carbon Steels S45C S55C	Alloy Steels SK / SCM SUS	Prehardened Steels NAK HPM	Hardened Steels					Cast Iron	Aluminum Alloys	Graphite	Copper	Plastics	Glass Filled Plastics	Titanium Alloys	Heat Resistant Alloys	Cemented Carbide	Hard Brittle (Non-Metallic) Materials
			~50HRC	~55HRC	~60HRC	~65HRC	~70HRC										
●	●	●	●	●							○						

Features

Extensive line up of tapered design from 30° to 15° of half included angle. Refer to page 568 for 4 flute C-CTE.

Total 108 models

Unit (mm)

Model Number	Tip Diameter	Half Included Angle	Length of Cut	Dia. at Large End	Overall Length	Shank Diameter	Suggested Retail Price ¥
C-CTE 2002-1	0.2	30°	0.8	0.21	38	3	15,500
C-CTE 2002-2		1°		0.23	38	3	15,500
C-CTE 2002-3		1°30'		0.24	38	3	15,500
C-CTE 2002-4		2°		0.26	38	3	15,500
C-CTE 2002-6		3°		0.28	38	3	15,500
C-CTE 2002-8		4°		0.31	38	3	16,500
C-CTE 2002-10		5°		0.34	38	3	18,500
C-CTE 2002-14		7°		0.40	38	3	20,000
C-CTE 2002-20		10°		0.48	38	3	22,000
C-CTE 2003-1		0.3		30°	1.2	0.32	38
C-CTE 2003-2	1°		0.34	38		3	13,000
C-CTE 2003-3	1°30'		0.36	38		3	13,000
C-CTE 2003-4	2°		0.38	38		3	13,000
C-CTE 2003-6	3°		0.43	38		3	13,000
C-CTE 2003-8	4°		0.47	38		3	14,000
C-CTE 2003-10	5°		0.51	38		3	15,000
C-CTE 2003-14	7°		0.59	38		3	16,500
C-CTE 2003-20	10°		0.72	38		3	18,500

Next Page ➡

- φ3mm Shank V Series
- UDC-PDC Series
- CBN Series
- Square
- Long Neck Square
- Radius
- Long Neck Radius
- Taper Neck Radius
- Ball / Long Shank Ball
- Long Neck Ball
- Taper Neck Ball
- Taper
- Barrel
- Spiral V Cutter
- Drill
- Technical Data

Unit (mm)

Model Number	Tip Diameter	Half Included Angle	Length of Cut	Dia. at Large End	Overall Length	Shank Diameter	Suggested Retail Price ¥		
C-CTE 2004-1	0.4	30°	1.6	0.43	38	3	13,000		
C-CTE 2004-2		1°		0.46	38	3	13,000		
C-CTE 2004-3		1°30'		0.48	38	3	13,000		
C-CTE 2004-4		2°		0.51	38	3	13,000		
C-CTE 2004-6		3°		0.57	38	3	13,000		
C-CTE 2004-8		4°		0.62	38	3	14,000		
C-CTE 2004-10		5°		0.68	38	3	15,000		
C-CTE 2004-14		7°		0.79	38	3	16,500		
C-CTE 2004-20		10°		0.96	38	3	18,500		
C-CTE 2005-1		0.5		30°	2	0.53	38	3	12,960
C-CTE 2005-2	1°		0.57	38		3	12,960		
C-CTE 2005-3	1°30'		0.60	38		3	12,960		
C-CTE 2005-4	2°		0.64	38		3	12,960		
C-CTE 2005-6	3°		0.71	38		3	12,960		
C-CTE 2005-8	4°		0.78	38		3	14,040		
C-CTE 2005-10	5°		0.85	38		3	15,120		
C-CTE 2005-14	7°		0.99	38		3	17,280		
C-CTE 2005-20	10°		1.21	38		3	18,360		
C-CTE 2005-24	12°		1.35	38		3	18,960		
C-CTE 2005-30	15°		1.57	38		3	19,680		
C-CTE 2006-1	0.6		30°	2		0.63	38	3	12,120
C-CTE 2006-2			1°			0.67	38	3	12,120
C-CTE 2006-3			1°30'			0.70	38	3	12,120
C-CTE 2006-4		2°	0.74		38	3	12,120		
C-CTE 2006-5		2°30'	0.77		38	3	12,120		
C-CTE 2006-6		3°	0.81		38	3	12,120		
C-CTE 2006-10		5°	0.95		38	3	14,280		
C-CTE 2006-14		7°	1.09		38	3	16,440		
C-CTE 2006-20		10°	1.31		38	3	17,520		
C-CTE 2006-24		12°	1.45		38	3	18,000		
C-CTE 2006-30		15°	1.67		38	3	18,600		
C-CTE 2008-1		0.8	30°		3	0.85	38	3	12,120
C-CTE 2008-2	1°		0.90	38		3	12,120		
C-CTE 2008-3	1°30'		0.96	38		3	12,120		
C-CTE 2008-4	2°		1.01	38		3	12,120		
C-CTE 2008-5	2°30'		1.06	38		3	12,120		
C-CTE 2008-6	3°		1.11	38		3	12,120		
C-CTE 2008-10	5°		1.32	38		3	14,280		
C-CTE 2008-14	7°		1.54	38		3	16,440		
C-CTE 2008-20	10°		1.86	38		3	17,520		
C-CTE 2008-24	12°		2.08	38		3	18,000		
C-CTE 2008-30	15°		2.41	38		3	18,600		
C-CTE 2010-1	1		30°	4		1.07	45	4	9,480
C-CTE 2010-2			1°			1.14	45	4	9,480
C-CTE 2010-3		1°30'	1.21		45	4	9,480		

Ø3mm Shank
V SeriesUDC-PCD
SeriesCBN
Series

Square

Square
Long Neck
Square

Radius

Radius
Long Neck
RadiusTaper Neck
RadiusBall / Long
Shank BallBall
Long Neck
BallTaper Neck
Ball

Taper

Taper

Barrel

Spiral
V Cutter

Drill

Technical Data

Next Page ➡

Unit (mm)

Model Number	Tip Diameter	Half Included Angle	Length of Cut	Dia. at Large End	Overall Length	Shank Diameter	Suggested Retail Price ¥		
C-CTE 2010-4	1	2°	4	1.28	45	4	9,480		
C-CTE 2010-5		2°30'		1.35	45	4	9,480		
C-CTE 2010-6		3°		1.42	45	4	9,720		
C-CTE 2010-8		4°		1.56	45	4	11,760		
C-CTE 2010-10		5°		1.70	45	4	11,760		
C-CTE 2010-14		7°		1.98	45	4	15,720		
C-CTE 2010-20		10°		2.41	45	4	16,800		
C-CTE 2010-24		12°		2.70	45	4	18,000		
C-CTE 2010-30		15°		3.14	50	6	18,720		
C-CTE 2015-1		1.5		30'	5	1.59	45	4	9,480
C-CTE 2015-2	1°		1.67	45		4	9,480		
C-CTE 2015-3	1°30'		1.76	45		4	9,480		
C-CTE 2015-4	2°		1.85	45		4	9,480		
C-CTE 2015-5	2°30'		1.94	45		4	9,480		
C-CTE 2015-6	3°		2.02	45		4	9,720		
C-CTE 2015-8	4°		2.20	45		4	11,760		
C-CTE 2015-10	5°		2.37	45		4	11,760		
C-CTE 2015-14	7°		2.73	45		4	15,720		
C-CTE 2015-20	10°		3.26	45		4	16,800		
C-CTE 2015-24	12°		3.63	45		4	18,000		
C-CTE 2015-30	15°		4.18	50		6	18,720		
C-CTE 2020-1	2		30'	6		2.10	45	4	9,480
C-CTE 2020-2			1°			2.21	45	4	9,480
C-CTE 2020-3			1°30'			2.31	45	4	9,480
C-CTE 2020-4		2°	2.42		45	4	9,480		
C-CTE 2020-5		2°30'	2.52		45	4	9,480		
C-CTE 2020-6		3°	2.63		45	4	9,720		
C-CTE 2020-8		4°	2.84		45	4	10,080		
C-CTE 2020-10		5°	3.05		45	4	11,200		
C-CTE 2020-14		7°	3.47		45	4	15,720		
C-CTE 2020-20		10°	4.12		50	6	18,720		
C-CTE 2020-24	12°	4.55	50	6	19,680				
C-CTE 2020-30	15°	5.22	50	6	20,640				
C-CTE 2025-1	2.5	30'	8	2.64	45	4	10,800		
C-CTE 2025-2		1°		2.78	45	4	10,800		
C-CTE 2025-3		1°30'		2.92	45	4	10,800		
C-CTE 2025-4		2°		3.06	45	4	10,800		
C-CTE 2025-5		2°30'		3.20	45	4	10,800		
C-CTE 2025-6		3°		3.34	45	4	10,800		
C-CTE 2025-8		4°		3.62	45	4	11,100		
C-CTE 2025-10		5°		3.90	45	4	11,400		
C-CTE 2025-14		7°		4.45	45	6	13,340		
C-CTE 2025-20		10°		5.32	50	6	24,150		
C-CTE 2025-24		12°		5.90	50	8	26,400		
C-CTE 2025-30		15°		6.79	50	8	27,500		

- ø3mm Shank V Series
- UDC-PCD Series
- CBN Series
- Square
- Long Neck Square
- Radius
- Long Neck Radius
- Taper Neck Radius
- Ball / Long Shank Ball
- Long Neck Ball
- Taper Neck Ball
- Taper
- Barrel
- Spiral V Cutter
- Drill
- Technical Data

Milling Conditions for C-CTE (2 Flutes)

WORK MATERIAL		CARBON STEELS ALLOY STEELS (~325HB)		TOOL STEELS PREHARDENED STEELS (30~40HRC)		PREHARDENED STEELS HARDENED STEELS (40~50HRC)	
Model Number	Tip Diameter (mm)	Spindle Speed (min ⁻¹)	Feed Rate (mm/min)	Spindle Speed (min ⁻¹)	Feed Rate (mm/min)	Spindle Speed (min ⁻¹)	Feed Rate (mm/min)
2002	0.2	32,000	45	25,000	30	18,000	20
2003	0.3	30,000	50	23,000	30	16,200	25
2004	0.4	28,000	60	21,000	35	14,500	25
2005	0.5	25,500	70	19,100	40	12,700	25
2006	0.6	21,300	70	15,900	40	10,600	25
2008	0.8	15,900	100	11,900	60	8,000	40
2010	1	12,800	150	9,600	110	6,400	70
2015	1.5	8,500	150	6,400	110	4,300	70
2020	2	6,400	150	4,800	110	3,200	70
2025	2.5	5,100	150	3,800	110	2,600	70

Milling Amount for Side Milling (mm)

\varnothing = Length of Cut

$\Delta t = \tan \text{Half Included Taper Angle} \times 0.9 \varnothing$

Note:

- Recommend water soluble or oil coolant.
- Recommend wet coolant for Copper.

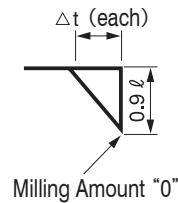

Square	Ø3mm Shank V Series
	UDC-PCD Series
Square	CBN Series
	Square
Radius	Long Neck Square
	Radius
Radius	Long Neck Radius
	Taper Neck Radius
Ball	Ball / Long Shank Ball
	Long Neck Ball
Taper	Taper Neck Ball
	Taper
Barrel	Barrel
Spiral V Cutter	Spiral V Cutter
Drill	Drill
Technical Data	Technical Data



Size $\phi 3 \sim \phi 10$

C-CTE4000



Material Applications (★ Highly Recommended ● Recommended ○ Suggested)

Work Material																	
Carbon Steels S45C S55C	Alloy Steels SK / SCM SUS	Prehardened Steels NAK HPM	Hardened Steels					Cast Iron	Aluminum Alloys	Graphite	Copper	Plastics	Glass Filled Plastics	Titanium Alloys	Heat Resistant Alloys	Cemented Carbide	Hard Brittle (Non-Metallic) Materials
			~50HRC	~55HRC	~60HRC	~65HRC	~70HRC										
●	●	●	●	●							○						

Features

Extensive line up of tapered design from 30° to 7° of half included angle. Refer to page 564 for 2 flute C-CTE.

Total 46 models

Unit (mm)

Model Number	Tip Diameter	Half Included Angle	Length of Cut	Dia. at Large End	Overall Length	Shank Diameter	Suggested Retail Price ¥
C-CTE 4030-1	3	30°	10	3.17	50	6	11,340
C-CTE 4030-2		1°		3.35	50	6	11,340
C-CTE 4030-3		1°30'		3.52	50	6	11,340
C-CTE 4030-4		2°		3.70	50	6	11,340
C-CTE 4030-5		2°30'		3.87	50	6	11,340
C-CTE 4030-6		3°		4.05	50	6	11,340
C-CTE 4030-10		5°		4.75	50	6	12,290
C-CTE 4030-14		7°		5.46	50	6	13,650
C-CTE 4040-1	4	30°	15	4.26	50	6	11,760
C-CTE 4040-2		1°		4.52	50	6	11,760
C-CTE 4040-3		1°30'		4.79	50	6	11,760
C-CTE 4040-4		2°		5.05	50	6	11,760
C-CTE 4040-5		2°30'		5.31	50	6	11,760
C-CTE 4040-6		3°		5.57	50	6	11,760
C-CTE 4040-10		5°		6.63	50	8	16,280
C-CTE 4040-14		7°		7.68	50	8	18,150

Next Page ➔

Unit (mm)

Model Number	Tip Diameter	Half Included Angle	Length of Cut	Dia. at Large End	Overall Length	Shank Diameter	Suggested Retail Price ¥
C-CTE 4050-1	5	30°	20	5.35	60	6	13,650
C-CTE 4050-2		1°		5.70	60	6	13,650
C-CTE 4050-3		1°30'		6.05	60	8	14,300
C-CTE 4050-4		2°		6.40	60	8	14,300
C-CTE 4050-5		2°30'		6.75	60	8	14,300
C-CTE 4050-6		3°		7.10	60	8	14,300
C-CTE 4050-10		5°		8.50	60	10	21,780
C-CTE 4050-14		7°		9.91	60	10	24,200
C-CTE 4060-1	6	30°	20	6.35	60	8	14,300
C-CTE 4060-2		1°		6.70	60	8	14,300
C-CTE 4060-3		1°30'		7.05	60	8	14,300
C-CTE 4060-4		2°		7.40	60	8	14,300
C-CTE 4060-5		2°30'		7.75	60	8	15,840
C-CTE 4060-6		3°		8.10	60	10	15,840
C-CTE 4060-10		5°		9.50	60	10	23,320
C-CTE 4060-14		7°		10.91	60	12	25,960
C-CTE 4080-1	8	30°	25	8.44	70	10	22,440
C-CTE 4080-2		1°		8.87	70	10	23,100
C-CTE 4080-3		1°30'		9.31	70	10	24,750
C-CTE 4080-4		2°		9.75	70	10	26,070
C-CTE 4080-5		2°30'		10.18	75	12	28,600
C-CTE 4080-6		3°		10.62	75	12	30,360
C-CTE 4080-10		5°		12.37	90	12	52,800
C-CTE 4100-1		10		30°	35	10.61	90
C-CTE 4100-2	1°		11.22	90		12	40,260
C-CTE 4100-3	1°30'		11.83	90		12	42,900
C-CTE 4100-4	2°		12.44	90		12	49,500
C-CTE 4100-5	2°30'		13.05	90		12	53,900
C-CTE 4100-6	3°		13.67	90		12	57,750
C-CTE 4100-10	5°		16.12	90		16	69,300

4 Flutes

Ø3mm Shank
V SeriesUDC-PCD
SeriesCBN
SeriesSquare
Square
Long Neck
SquareRadius
Radius
Long Neck
RadiusTaper Neck
RadiusBall / Long
Shank BallLong Neck
BallTaper Neck
BallTaper
Taper

Barrel

Spiral
V Cutter

Drill

Technical Data

Milling Conditions for C-CTE (4 Flutes)

WORK MATERIAL		CARBON STEELS ALLOY STEELS (~325HB)		TOOL STEELS PREHARDENED STEELS (30~40HRC)		PREHARDENED STEELS HARDENED STEELS (40~50HRC)	
Model Number	Tip Diameter (mm)	Spindle Speed (min ⁻¹)	Feed Rate (mm/min)	Spindle Speed (min ⁻¹)	Feed Rate (mm/min)	Spindle Speed (min ⁻¹)	Feed Rate (mm/min)
4030	3	4,200	200	3,200	150	2,100	90
4040	4	3,200	200	2,400	150	1,600	90
4050	5	2,600	200	1,900	150	1,300	90
4060	6	2,100	200	1,600	150	1,100	90
4080	8	1,600	200	1,200	150	800	90
4100	10	1,300	200	1,000	150	600	90

Milling Amount for Side Milling(mm)

ℓ = Length of Cut

$\Delta t = \tan \text{ Half Included Taper Angle} \times 0.9 \ell$

Note:

- Recommend water soluble or oil coolant.
- Recommend wet coolant for Copper.

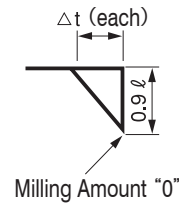

- 3mm Shank V Series
- UDC-PCD Series
- CBN Series
- Square
- Long Neck Square
- Radius
- Long Neck Radius
- Taper Neck Radius
- Ball / Long Shank Ball
- Long Neck Ball
- Taper Neck Ball
- Taper
- Barrel
- Spiral V Cutter
- Drill
- Technical Data

Milling Example of Convex and Concave

STAVAX (52HRC)

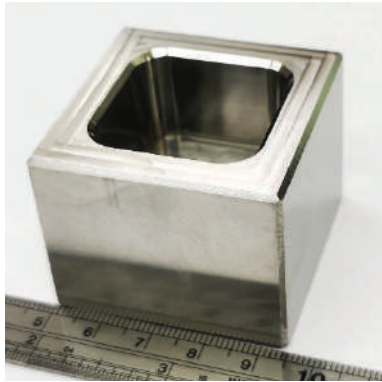

4 Flute Highly Efficient Radius HRRS

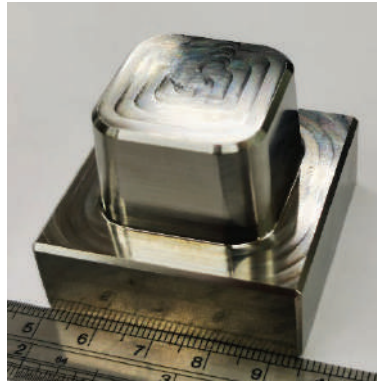

4 Flute Taper End Mill C-CTE4000



Work Size
45 × 45 × 35 mm

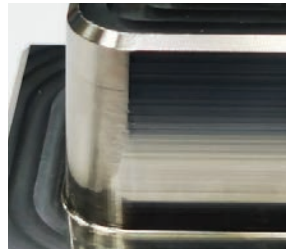

No chattering with both side of work and corner. Uniform milling surface.

Tool	Spindle Speed (min ⁻¹)	Feed Rate (mm/min)	a _p (mm)	a _e (mm)	Cycle Time (m:s)
4 Flute Highly Efficient Radius HRRS φ6 × CR0.5	6,500	600	0.02	2.5	3min 7 sec
4 Flute Taper End Mill C-CTE4000 φ6 × Half Included Angle 3°	2,200	300	20	0.03	1min 43 sec

4 Flutes

φ3mm Shank
V Series

UDC-PCD
Series

CBN
Series

Square

Square

Long Neck
Square

Radius

Radius

Long Neck
Radius

Taper Neck
Radius

Ball / Long
Shank Ball

Ball

Long Neck
Ball

Taper Neck
Ball

Taper

Taper

Barrel

Spiral
V Cutter

Drill

Technical Data



COVB

Super MG
UT COAT
Form ±0.01
Shank Dia 0/-0.005

NEW

Material Applications (★ Highly Recommended ● Recommended ○ Suggested)

Work Material																	
Carbon Steels S45C S55C	Alloy Steels SK / SCM SUS	Prehardened Steels NAK HPM	Hardened Steels					Cast Iron	Aluminum Alloys	Graphite	Copper	Plastics	Glass Filled Plastics	Titanium Alloys	Heat Resistant Alloys	Cemented Carbide	Hard Brittle (Non-Metallic) Materials
			~50HRC	~55HRC	~60HRC	~65HRC	~70HRC										
●	●	●	●	●				○	●		●			○	○		

Features

Broad range of application available with UTCOAT.
Suitable for narrow interference area with small inclined angle.

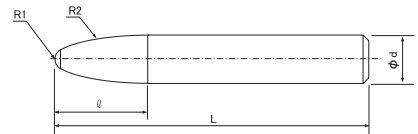
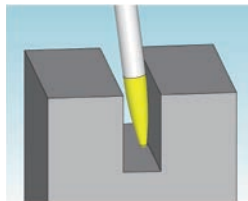

Total 4 models

Unit (mm)

Model Number	Tip R R1	Barrel R R2	Length of Cut ℓ	Overall Length L	Shank Diameter φd	Suggested Retail Price ¥
COVB 4020-85	R1	R85	19.2	60	6	23,400
COVB 4020-90		R90	23.9	70	8	29,000
COVB 4040-80	R2	R80	23.4	80	10	33,330
COVB 4040-80-12		R80	26.6	80	12	40,320

- 3mm Shank V Series
- UDC-PCD Series
- CBN Series
- Square
- Long Neck Square
- Radius
- Long Neck Radius
- Taper Neck Radius
- Ball / Long Shank Ball
- Long Neck Ball
- Taper Neck Ball
- Taper
- Barrel
- Spiral V Cutter
- Drill
- Technical Data

Milling Conditions for COVB

WORK MATERIAL			ALUMINUM ALLOYS A7075				PREHARDENED STEELS PXA30(30~45HRC)				HARDENED STEELS SKD61 / STAVAX(45~55HRC)			
Model Number	Tip R (mm)	Barrel R (mm)	Spindle Speed (min ⁻¹)	Feed Rate (mm/min)	a_p Axial Depth (mm)	a_e Radial Depth (mm)	Spindle Speed (min ⁻¹)	Feed Rate (mm/min)	a_p Axial Depth (mm)	a_e Radial Depth (mm)	Spindle Speed (min ⁻¹)	Feed Rate (mm/min)	a_p Axial Depth (mm)	a_e Radial Depth (mm)
4020-85	R1	R85	10,500	2,400	2.85	0.1	4,700	1,070	2.4	0.1	3,800	900	1.9	0.07
4020-90		R90	9,250	2,200	3.6	0.1	4,250	980	2.9	0.1	3,500	850	2.4	0.07
4040-80	R2	R80	8,000	2,000	3.5	0.1	3,800	900	3	0.1	3,200	800	2.4	0.07
4040-80-12		R80	6,750	1,800	4	0.1	3,350	900	3.4	0.1	2,900	750	2.7	0.07

Note:

·Set spindle speed, feed rate, and axial depth (a_p) in accordance with the required surface quality.

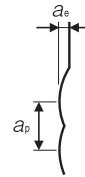

4 Flutes

∅3mm Shank
V Series

UDC-PCD
Series

CBN
Series

Square

Square

Long Neck
Square

Radius

Radius

Long Neck
Radius

Taper Neck
Radius

Ball

Ball / Long
Shank Ball

Long Neck
Ball

Taper Neck
Ball

Taper

Taper

Barrel

Spiral
V Cutter

Drill

Technical Data



CSTB

Super
MG

UT
COAT

Form
±0.01

Shank Dia
0/-0.005

NEW

Material Applications (★ Highly Recommended ● Recommended ○ Suggested)

Work Material																	
Carbon Steels S45C S55C	Alloy Steels SK / SCM SUS	Prehardened Steels NAK HPM	Hardened Steels					Cast Iron	Aluminum Alloys	Graphite	Copper	Plastics	Glass Filled Plastics	Titanium Alloys	Heat Resistant Alloys	Cemented Carbide	Hard Brittle (Non-Metallic) Materials
			~50HRC	~55HRC	~60HRC	~65HRC	~70HRC										
●	●	●	●	●				○	●		●			○	○		

Features

**Broad range of application available with UTCOAT.
Suitable for finishing on straight and inclined walls with larger barrel R.**

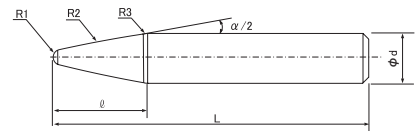
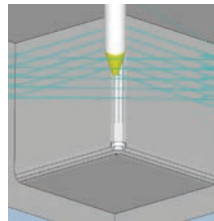

Total 5 models

Unit (mm)

Model Number	Half Included Angle $\alpha/2$	Tip R R1	Barrel R R2	Third R R3	Length of Cut l	Overall Length L	Shank Diameter ϕd	Suggested Retail Price ¥
CSTB 4020-200-30	15°	R1	R200	R3	8.6	60	6	23,400
CSTB 4030-250-40	20°	R1.5	R250	R4	8.7	70	8	29,000
CSTB 4040-250-40	20°	R2	R250	R5	10.7	80	10	33,330
CSTB 4060-250-45	22.5°	R3	R250	R6	10.7	100	12	40,320
CSTB 4020-200-85	42.5°	R1	R200	R1	6.4	100	12	40,320

φ3mm Shank
V Series

UDC-PCD
Series

CBN
Series

Square
Long Neck
Square

Radius

Long Neck
Radius
Taper Neck
Radius

Ball / Long
Shank Ball
Long Neck
Ball
Taper Neck
Ball

Taper

Barrel

Spiral
V Cutter

Drill

Technical Data

Milling Conditions for CSTB

WORK MATERIAL			ALUMINUM ALLOYS A7075				PREHARDENED STEELS PXA30(30~45HRC)				HARDENED STEELS SKD61 / STAVAX(45~55HRC)			
Model Number	Tip R (mm)	Barrel R (mm)	Spindle Speed (min ⁻¹)	Feed Rate (mm/min)	a_p Axial Depth (mm)	a_e Radial Depth (mm)	Spindle Speed (min ⁻¹)	Feed Rate (mm/min)	a_p Axial Depth (mm)	a_e Radial Depth (mm)	Spindle Speed (min ⁻¹)	Feed Rate (mm/min)	a_p Axial Depth (mm)	a_e Radial Depth (mm)
4020-200-30	R1	R200	18,000	2,400	2.85	0.1	11,500	1,800	1.9	0.075	9,000	1,440	1.5	0.075
4030-250-40	R1.5	R250	15,600	2,400	2.85	0.1	10,300	1,600	2.4	0.075	8,000	1,200	2	0.075
4040-250-40	R2	R250	13,200	2,400	2.85	0.1	9,100	1,600	2.4	0.075	7,000	1,200	2	0.075
4060-250-45	R3	R250	10,800	2,400	2.85	0.1	8,000	1,600	2.4	0.075	6,000	1,200	2	0.075
4020-200-85	R1	R200	10,800	1,200	2.85	0.1	8,000	700	2	0.075	6,000	500	2	0.05

Note:

·Set spindle speed, feed rate, and axial depth (a_p) in accordance with the required surface quality.

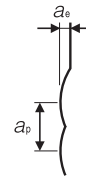

4 Flutes

Ø3mm Shank
V Series

UDC-PCD
Series

CBN
Series

Square

Square

Long Neck
Square

Radius

Radius

Long Neck
Radius

Taper Neck
Radius

Ball

Ball / Long
Shank Ball

Long Neck
Ball

Taper Neck
Ball

Taper

Taper

Barrel

Spiral
V Cutter

Drill

Technical Data



CWTB

Super
MG

UT
COAT

Form
±0.01

Shank Dia
0/-0.005

NEW

Material Applications (★ Highly Recommended ● Recommended ○ Suggested)

Work Material																	
Carbon Steels S45C S55C	Alloy Steels SK / SCM SUS	Prehardened Steels NAK HPM	Hardened Steels					Cast Iron	Aluminum Alloys	Graphite	Copper	Plastics	Glass Filled Plastics	Titanium Alloys	Heat Resistant Alloys	Cemented Carbide	Hard Brittle (Non-Metallic) Materials
			~50HRC	~55HRC	~60HRC	~65HRC	~70HRC										
●	●	●	●	●				○	●		●			○	○		

Features

Broad range of application available with UTCOAT.
Suitable for finishing on flat surface with wide taper angle.

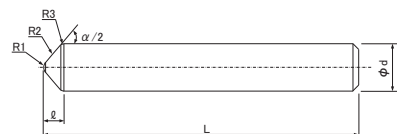
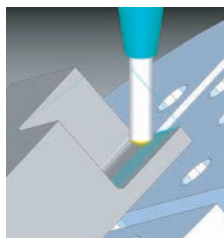

Total 2 models

Unit (mm)

Model Number	Half Included Angle $\alpha/2$	Tip R R1	Barrel R R2	Third R R3	Length of Cut l	Overall Length L	Shank Diameter ϕd	Suggested Retail Price ¥
CWTB 4020-200-100	50°	R1	R200	R1	4.3	80	10	25,140
CWTB 4020-250-130	65°		R250		2.8	80	10	25,140

□3mm Shank
V Series

UDC-PCD
Series

CBN
Series

Square
Long Neck
Square

Radius

Long Neck
Radius
Taper Neck
Radius

Ball / Long
Shank Ball
Long Neck
Ball
Taper Neck
Ball

Taper

Barrel

Spiral
V Cutter

Drill

Technical Data

Milling Conditions for CWTB

WORK MATERIAL			ALUMINUM ALLOYS A7075				PREHARDENED STEELS PXA30(30~45HRC)				HARDENED STEELS SKD61 / STAVAX(45~55HRC)			
Model Number	Tip R (mm)	Barrel R (mm)	Spindle Speed (min ⁻¹)	Feed Rate (mm/min)	a_p Axial Depth (mm)	a_e Radial Depth (mm)	Spindle Speed (min ⁻¹)	Feed Rate (mm/min)	a_p Axial Depth (mm)	a_e Radial Depth (mm)	Spindle Speed (min ⁻¹)	Feed Rate (mm/min)	a_p Axial Depth (mm)	a_e Radial Depth (mm)
4020-200-100	R1	R200	20,000	5,000	0.2	4	12,000	2,400	0.1	4	9,000	1,100	0.075	4
4020-250-130		R250	20,000	5,000	0.1	2.5	12,000	2,400	0.1	2.5	9,000	1,100	0.075	2.5

Note:

·Set spindle speed, feed rate, and radial depth (a_e) in accordance with the required surface quality.

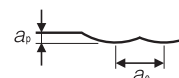

4 Flutes

∅3mm Shank
V Series

UDC-PCD
Series

CBN
Series

Square

Square

Long Neck
Square

Radius

Radius

Long Neck
Radius

Taper Neck
Radius

Ball

Ball / Long
Shank Ball

Long Neck
Ball

Taper Neck
Ball

Taper

Taper

Barrel

Spiral
V Cutter

Drill

Technical Data



Size $\phi 3 \sim \phi 12$

SV



Material Applications (★ Highly Recommended ● Recommended ○ Suggested)

Work Material																	
Carbon Steels S45C S55C	Alloy Steels SK / SCM SUS	Prehardened Steels NAK HPM	Hardened Steels					Cast Iron	Aluminum Alloys	Graphite	Copper	Plastics	Glass Filled Plastics	Titanium Alloys	Heat Resistant Alloys	Cemented Carbide	Hard Brittle (Non-Metallic) Materials
			~50HRC	~55HRC	~60HRC	~65HRC	~70HRC										
●	●	●						○	○	○	○	○					

Features

Spiral type chamfering cutter.

Half included angle 45° .

By applying a spiral peripheral cutting edge, burrs are greatly reduced when compared to a straight cutting edge design.

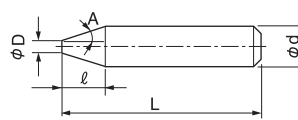
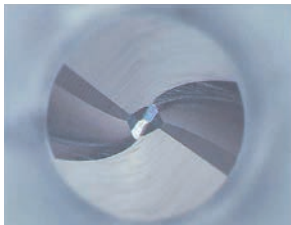

Total 6 models

Unit (mm)

Model Number	Tip Diameter ϕD	Length of Cut ℓ	Overall Length L	Half Included Angle A	Shank Diameter ϕd	Suggested Retail Price ¥
SV 2030	0.8	1.1	40	45°	3	13,000
SV 2040		1.6	45		4	14,000
SV 2060	1	2.5	50		6	15,750
SV 2080		3.5	60		8	19,250
SV 2100		4.5	70		10	27,500
SV 2120		5.5	75		12	32,230

- φ3mm Shank V Series
- UDC-PCD Series
- CBN Series
- Square
- Long Neck Square
- Radius
- Long Neck Radius
- Taper Neck Radius
- Ball / Long Shank Ball
- Long Neck Ball
- Taper Neck Ball
- Taper
- Barrel
- Spiral V Cutter
- Drill
- Technical Data

Milling Conditions for SV

WORK MATERIAL		CARBON STEELS S45C / S50C (~225HB)		ALLOY STEELS SK / SCM / SUS (225~325HB)		PREHARDENED STEELS HARDENED STEELS NAK / SKD (30~45HRC)	
Model Number	Shank Diameter (mm)	Spindle Speed (min ⁻¹)	Feed Rate (mm/min)	Spindle Speed (min ⁻¹)	Feed Rate (mm/min)	Spindle Speed (min ⁻¹)	Feed Rate (mm/min)
2030	3	2,700~5,300	59~86	2,100~4,200	46~67	1,600~3,200	35~51
2040	4	2,000~4,000	48~68	1,600~3,200	38~54	1,200~2,400	29~41
2060	6	1,300~2,700	36~49	1,100~2,100	31~42	800~1,600	22~30
2080	8	1,000~2,000	32~42	800~1,600	26~34	600~1,200	22~30
2100	10	800~1,600	30~37	640~1,300	23~29	600~1,200	17~22
2120	12	700~1,300	28~35	530~1,100	21~27	400~800	17~22

Milling Amount (mm)

$$a_p = 0.1D$$

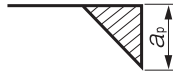
 a_p : Axial Depth (mm)

Note:

- The figures listed above are for nominal diameters. Adjust the speed and feed rate according to the correct diameter.
- Recommend slot milling with the tip flutes. Decrease the feed rate 50% from the milling parameters in this case.
- Recommend water soluble or oil coolant.

 Ø3mm Shank
V Series

 UDC-PCD
Series

 CBN
Series

 Square
Long Neck
Square

Square

Long Neck
Square
 Radius
Long Neck
Radius

Radius

Long Neck
RadiusTaper Neck
Radius
 Ball
Long Neck
Ball
Ball / Long
Shank BallLong Neck
BallTaper Neck
Ball

Taper

Taper

Barrel

Barrel

Spiral
V CutterSpiral
V Cutter

Drill

Drill

Technical Data

Technical Data



Size $\phi 2 \sim \phi 12$

UTDF



Patented in Japan

Material Applications (★ Highly Recommended ● Recommended ○ Suggested)

Work Material																		
Structural Steels SS400	Carbon Steels S45C S55C	Alloy Steels SK / SCM SUS	Prehardened Steels NAK HPM	Hardened Steels					Cast Iron	Aluminum Alloys	Graphite	Copper	Plastics	Glass Filled Plastics	Titanium Alloys	Heat Resistant Alloys	Cemented Carbide	Hard Brittle (Non-Metallic) Materials
				~ 50HRC	~ 55HRC	~ 60HRC	~ 65HRC	~ 70HRC										
●	●	●	○						●	●								

Features

Available to a wide variety of applications by the 180° point angle.
 The helix angle of 30° offers excellent chip evacuation, stable and highly efficient pilot hole drilling.
 New web-thinning design for improved chip evacuation and sharpness.
 Double-margin will guide the tool into inner wall and achieve high-straightness drilling to non-planar surface.
 Size M4 - M12 for drilling pilot holes before tapping.

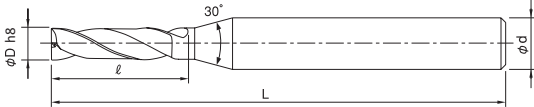

Outside Diameter	Diameter Tolerance(h8)
$\phi D \leq 3$	0/-0.014
$3 < \phi D \leq 6$	0/-0.018
$6 < \phi D \leq 10$	0/-0.022
$10 < \phi D \leq 12$	0/-0.027

Feature1 : Helix angle 30°



Excellent chip evacuation with 30° helix angle

Feature2 : Double-margin

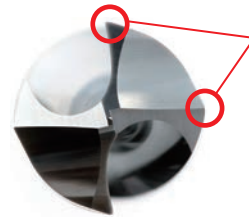

Double-margin

High-straightness drilling

Feature3 : A wide variety of applications

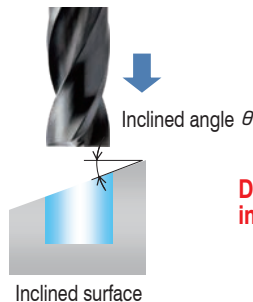
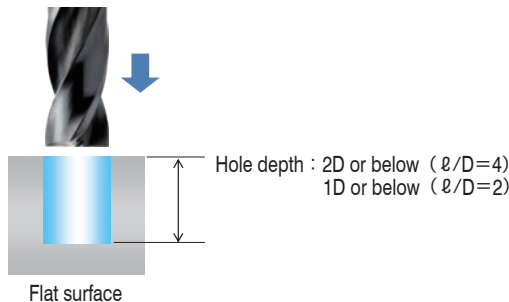

Designed for drilling on flat, inclined or curved surfaces.

φ3mm Shank V Series

UDC-PCD Series

CBN Series

Square
Long Neck Square

Radius
Long Neck Radius
Taper Neck Radius

Ball / Long Shank Ball
Long Neck Ball
Taper Neck Ball

Taper

Barrel

Spiral V Cutter

Drill

Technical Data

Total 21 models

Unit (mm)

Model Number	Diameter ϕ D	Flute Length ℓ	Overall Length L	Shank Diameter ϕ d	Suggested Retail Price ¥
UTDF 2200-080	2	8	50	4	6,500
UTDF 2250-100	2.5	10	50	4	6,500
UTDF 2300-120	3	12	60	6	6,500
UTDF 2330-132	3.3	13.2	60	6	7,000
UTDF 2400-160	4	16	60	6	7,200
UTDF 2420-168	4.2	16.8	60	6	7,500
UTDF 2500-200	5	20	60	6	7,800
UTDF 2510-204	5.1	20.4	60	6	7,800
UTDF 2600-240	6	24	60	6	8,000
UTDF 2650-130	6.5	13	70	8	9,700
UTDF 2680-272	6.8	27.2	70	8	9,700
UTDF 2700-280	7	28	80	8	9,700
UTDF 2800-320	8	32	80	8	10,500
UTDF 2850-340	8.5	34	80	10	11,500
UTDF 2860-344	8.6	34.4	80	10	11,500
UTDF 2900-360	9	36	80	10	13,500
UTDF 2950-190	9.5	19	90	10	13,500
UTDF 21000-400	10	40	90	10	13,500
UTDF 21030-412	10.3	41.2	90	12	14,000
UTDF 21100-220	11	22	100	12	15,500
UTDF 21200-480	12	48	100	12	15,500

*Contact our sales for the custom size tool.

ϕ 3mm Shank
V Series

UDC-PCD
Series

CBN
Series

Square

Long Neck
Square

Radius

Long Neck
Radius

Taper Neck
Radius

Ball / Long
Shank Ball

Long Neck
Ball

Taper Neck
Ball

Taper

Barrel

Spiral
V Cutter

Drill

Technical Data

Drilling Conditions for UTDF

Flat Surface

WORK MATERIAL			CARBON STEELS STRUCTURAL STEELS GRAY CAST IRON S50C / SS400 / FC250	ALLOY STEELS SCM415	PREHARDENED STEELS NAK80	DUCTILE IRON FCD	ALUMINUM ALLOYS A5052 / A7075	ALUMINUM CAST ADC12						
Model Number	Diameter ϕD (mm)	Flute Length l_f (mm)	Spindle Speed (min ⁻¹)	Feed Rate (mm/min)	Spindle Speed (min ⁻¹)	Feed Rate (mm/min)	Spindle Speed (min ⁻¹)	Feed Rate (mm/min)	Spindle Speed (min ⁻¹)	Feed Rate (mm/min)	Spindle Speed (min ⁻¹)	Feed Rate (mm/min)	Spindle Speed (min ⁻¹)	Feed Rate (mm/min)
2200-080	2	8	15,000	900	12,900	740	6,000	160	12,900	660	25,200	2,070	18,900	1,340
	2.5	10	12,000	880	10,320	730	4,800	160	10,320	660	20,160	2,070	15,120	1,340
2300-120	3	12	10,000	860	8,600	710	4,000	150	8,600	630	16,800	1,970	12,600	1,280
2330-132	3.3	13.2	9,090	860	7,820	710	3,640	150	7,820	630	15,280	1,970	11,460	1,280
2400-160	4	16	7,500	830	6,450	690	3,000	150	6,450	610	12,600	1,900	9,450	1,230
2420-168	4.2	16.8	7,150	830	6,150	690	2,860	150	6,150	610	12,000	1,900	9,000	1,230
2500-200	5	20	6,000	800	5,160	660	2,400	140	5,160	590	10,080	1,840	7,560	1,190
2510-204	5.1	20.4	5,880	800	5,060	660	2,350	140	5,060	590	9,880	1,840	7,400	1,190
2600-240	6	24	5,000	770	4,300	640	2,000	140	4,300	560	8,400	1,770	6,300	1,140
2650-130	6.5	13	4,620	770	3,970	640	1,850	140	3,970	560	7,750	1,770	5,820	1,140
2680-272	6.8	27.2	4,420	770	3,800	640	1,770	140	3,800	560	7,420	1,770	5,560	1,140
2700-280	7	28	4,290	760	3,680	630	1,710	140	3,680	560	7,200	1,770	5,400	1,140
2800-320	8	32	3,750	730	3,230	600	1,500	130	3,230	540	6,300	1,670	4,730	1,080
2850-340	8.5	34	3,530	730	3,040	600	1,420	130	3,040	540	5,930	1,670	4,450	1,080
2860-344	8.6	34.4	3,490	720	3,000	600	1,400	130	3,000	540	5,860	1,670	4,400	1,080
2900-360	9	36	3,330	720	2,870	590	1,330	120	2,870	530	5,600	1,670	4,200	1,080
2950-190	9.5	19	3,160	700	2,720	580	1,260	120	2,720	520	5,300	1,620	3,980	1,050
21000-400	10	40	3,000	690	2,580	570	1,200	120	2,580	510	5,040	1,580	3,780	1,020
21030-412	10.3	41.2	2,920	690	2,510	570	1,170	120	2,510	510	4,900	1,580	3,670	1,020
21100-220	11	22	2,730	670	2,350	550	1,090	110	2,350	500	4,580	1,540	3,440	1,000
21200-480	12	48	2,500	650	2,150	540	1,000	110	2,150	480	4,200	1,490	3,150	960

φ3mm Shank V Series

UDC-PCD Series

CBN Series

Square
Long Neck Square

Radius

Radius
Long Neck Radius
Taper Neck Radius

Ball / Long Shank Ball

Ball
Long Neck Ball
Taper Neck Ball

Taper

Barrel

Spiral V Cutter

Drill

Technical Data

Drilling Conditions for UTDF

Inclined Surface ($\theta \leq 30^\circ$)

WORK MATERIAL			CARBON STEELS STRUCTURAL STEELS GRAY CAST IRON S50C / SS400 / FC250		ALLOY STEELS SCM415		PREHARDENED STEELS NAK80		DUCTILE IRON FCD		ALUMINUM ALLOYS A5052 / A7075		ALUMINUM CAST ADC12	
Model Number	Diameter ϕD (mm)	Flute Length l (mm)	Spindle Speed (min^{-1})	Feed Rate (mm/min)	Spindle Speed (min^{-1})	Feed Rate (mm/min)	Spindle Speed (min^{-1})	Feed Rate (mm/min)	Spindle Speed (min^{-1})	Feed Rate (mm/min)	Spindle Speed (min^{-1})	Feed Rate (mm/min)	Spindle Speed (min^{-1})	Feed Rate (mm/min)
2200-080	2	8	15,000	270	12,900	220	6,000	48	12,900	190	25,200	620	18,900	400
2250-100	2.5	10	12,000	260	10,320	220	4,800	48	10,320	190	20,160	620	15,120	400
2300-120	3	12	10,000	250	8,600	210	4,000	45	8,600	180	16,800	590	12,600	380
2330-132	3.3	13.2	9,090	250	7,820	210	3,640	45	7,820	180	15,280	590	11,460	380
2400-160	4	16	7,500	240	6,450	200	3,000	45	6,450	180	12,600	570	9,450	360
2420-168	4.2	16.8	7,150	240	6,150	200	2,860	45	6,150	180	12,000	570	9,000	360
2500-200	5	20	6,000	240	5,160	190	2,400	42	5,160	170	10,080	550	7,560	350
2510-204	5.1	20.4	5,880	230	5,060	190	2,350	42	5,060	170	9,880	550	7,400	350
2600-240	6	24	5,000	230	4,300	190	2,000	42	4,300	160	8,400	530	6,300	340
2650-130	6.5	13	4,620	230	3,970	190	1,850	42	3,970	160	7,750	530	5,820	340
2680-272	6.8	27.2	4,420	230	3,800	190	1,770	42	3,800	160	7,420	530	5,560	340
2700-280	7	28	4,290	230	3,680	190	1,710	42	3,680	160	7,200	530	5,400	340
2800-320	8	32	3,750	210	3,230	180	1,500	39	3,230	160	6,300	500	4,730	320
2850-340	8.5	34	3,530	210	3,040	180	1,420	39	3,040	160	5,930	500	4,450	320
2860-344	8.6	34.4	3,490	210	3,000	180	1,400	39	3,000	160	5,860	500	4,400	320
2900-360	9	36	3,330	210	2,870	180	1,330	38	2,870	160	5,600	500	4,200	320
2950-190	9.5	19	3,160	210	2,720	170	1,260	36	2,720	150	5,300	490	3,980	310
21000-400	10	40	3,000	200	2,580	170	1,200	36	2,580	150	5,040	470	3,780	300
21030-412	10.3	41.2	2,920	200	2,510	170	1,170	36	2,510	150	4,900	470	3,670	300
21100-220	11	22	2,730	200	2,350	160	1,090	34	2,350	140	4,580	460	3,440	290
21200-480	12	48	2,500	190	2,150	160	1,000	33	2,150	140	4,200	440	3,150	280

$\phi 3\text{mm}$ Shank
V Series

UDC-PCD
Series

CBN
Series

Square

Long Neck
Square

Radius

Long Neck
Radius

Taper Neck
Radius

Ball / Long
Shank Ball

Long Neck
Ball

Taper Neck
Ball

Taper

Barrel

Spiral
V Cutter

Drill

Technical Data

Drilling Conditions for UTDF

Inclined Surface ($\theta > 30^\circ$)

WORK MATERIAL			CARBON STEELS STRUCTURAL STEELS GRAY CAST IRON S50C / SS400 / FC250	ALLOY STEELS SCM415	PREHARDENED STEELS NAK80	DUCTILE IRON FCD	ALUMINUM ALLOYS A5052 / A7075	ALUMINUM CAST ADC12						
Model Number	Diameter ϕD (mm)	Flute Length ℓ (mm)	Spindle Speed (min ⁻¹)	Feed Rate (mm/min)	Spindle Speed (min ⁻¹)	Feed Rate (mm/min)	Spindle Speed (min ⁻¹)	Feed Rate (mm/min)	Spindle Speed (min ⁻¹)	Feed Rate (mm/min)	Spindle Speed (min ⁻¹)	Feed Rate (mm/min)	Spindle Speed (min ⁻¹)	Feed Rate (mm/min)
2200-080	2	8	10,500	90	9,030	74	4,200	16	9,030	66	17,640	200	13,230	130
2250-100	2.5	10	8,400	90	7,220	74	3,360	16	7,220	66	14,110	200	10,580	130
2300-120	3	12	7,000	86	6,020	71	2,800	15	6,020	63	11,760	190	8,820	120
2330-132	3.3	13.2	6,370	86	5,480	71	2,550	15	5,480	63	10,700	190	8,030	120
2400-160	4	16	5,250	83	4,520	69	2,100	15	4,520	61	8,820	190	6,620	120
2420-168	4.2	16.8	5,010	83	4,310	69	2,010	15	4,310	61	8,400	190	6,300	120
2500-200	5	20	4,200	80	3,620	66	1,680	14	3,620	59	7,060	180	5,300	110
2510-204	5.1	20.4	4,120	80	3,540	66	1,650	14	3,540	59	6,920	180	5,190	110
2600-240	6	24	3,500	77	3,010	64	1,400	14	3,010	56	5,880	170	4,410	110
2650-130	6.5	13	3,230	77	2,780	64	1,290	14	2,780	56	5,430	170	4,070	110
2680-272	6.8	27.2	3,100	77	2,660	64	1,240	14	2,660	56	5,200	170	3,900	110
2700-280	7	28	3,000	77	2,580	64	1,200	14	2,580	56	5,040	170	3,780	110
2800-320	8	32	2,630	73	2,270	60	1,050	13	2,270	54	4,410	160	3,320	100
2850-340	8.5	34	2,480	73	2,130	60	1,000	13	2,130	54	4,160	160	3,120	100
2860-344	8.6	34.4	2,440	73	2,100	60	980	13	2,100	54	4,100	160	3,080	100
2900-360	9	36	2,330	73	2,010	60	930	13	2,010	54	3,920	160	2,940	100
2950-190	9.5	19	2,210	71	1,900	58	880	12	1,900	53	3,710	150	2,790	100
21000-400	10	40	2,100	69	1,810	57	840	12	1,810	51	3,530	150	2,650	100
21030-412	10.3	41.2	2,050	69	1,760	57	820	12	1,760	51	3,430	150	2,570	100
21100-220	11	22	1,910	67	1,640	55	760	11	1,640	49	3,210	140	2,400	90
21200-480	12	48	1,750	65	1,510	54	700	11	1,510	48	2,940	140	2,210	90

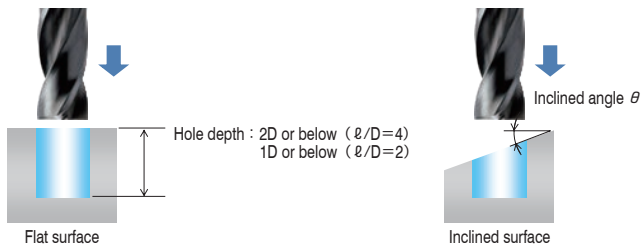

Note:

- These milling parameters are for reference only.
- Adjust the parameters in accordance with the machine rigidity, workpiece clamping condition and shape.
- Recommend water soluble or oil coolant.
- Step milling is recommended in case of clogging.

UTDF Inclined Surface Drilling Example **SS400**
 $\phi 3.5 \times$ Flute Length 14 mm (Prototype)

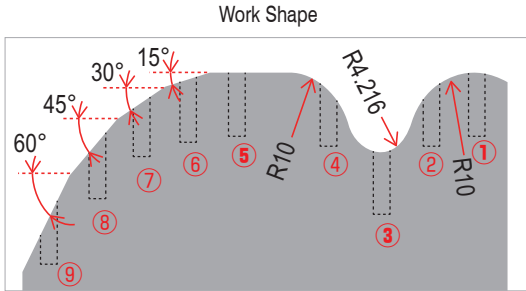

Coolant : Water Soluble (Nozzle)
 Work Size : 40 × 75 × 60 mm

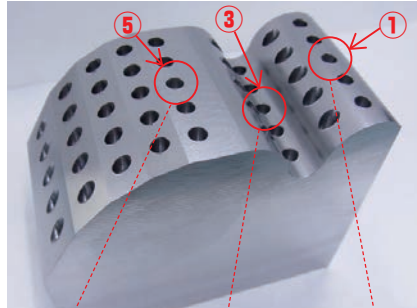

Each hole after drilling
Excellent drilling performance with less burrs.

Drilling spot	Surface	Spindle Speed (min ⁻¹)	Feed Rate (min/min)	Drilling Depth (The Deepest spot) (mm)
1	凸 Curved surface (Top)	7,000	450	7
2	Curved surface (45°)		270	
3	凹 Curved surface (Top)		450	
4	Curved surface (45°)		270	
5	Flat Surface		450	
6	Inclined Surface (15°)		320	
7	Inclined Surface (30°)		320	
8	Inclined Surface (45°)		270	
9	Inclined Surface (60°)		225	

*Contact our sales for the custom size tool.

UTDF
 Inclined Surface
 Drilling Video



Tool After Drilling $\phi 2 \times$ Flute Length 8 mm **A5052**

Surface	Spindle Speed	Feed Rate	Drilling Depth	Number of Holes	Coolant
Flat Surface	23,100 min ⁻¹	830 mm/min	4 mm	100 holes	Water Soluble (Nozzle)

Comparison of Tip Damage after 100 hits

UTDF



Competitor



More tool-life left without adhesion after drilling 100 holes.

Chip adhesion

- $\phi 3$ mm Shank V Series
- UDC-PCD Series
- CBN Series
- Square
- Long Neck Square
- Radius
- Long Neck Radius
- Taper Neck Radius
- Ball / Long Shank Ball
- Long Neck Ball
- Taper Neck Ball
- Taper
- Barrel
- Spiral V Cutter
- Drill
- Technical Data



Size $\phi 0.3 \sim \phi 2$

UTDSX



Material Applications (★ Highly Recommended ● Recommended ○ Suggested)

Work Material																		
Structural Steels SS400	Carbon Steels S45C S55C	Alloy Steels SK / SCM SUS	Prehardened Steels NAK HPM	Hardened Steels					Cast Iron	Aluminum Alloys	Graphite	Copper	Plastics	Glass Filled Plastics	Titanium Alloys	Heat Resistant Alloys	Cemented Carbide	Hard Brittle (Non-Metallic) Materials
				~ 50HRC	~ 55HRC	~ 60HRC	~ 65HRC	~ 70HRC										
●	●	●	○	Contact sales when drilling over 45HRC.					○	●		○				○	○	

Total 35 models

Unit (mm)

Model Number	Diameter ϕD	Flute Length ℓ	Overall Length L	Shank Diameter ϕd	Suggested Retail Price ¥
UTDSX 2030-015	0.3	1.5	38	3	3,470
UTDSX 2035-018	0.35	1.8	38	3	3,860
UTDSX 2040-020	0.4	2	38	3	3,470
UTDSX 2045-023	0.45	2.3	38	3	3,860
UTDSX 2050-025	0.5	2.5	38	3	3,860
UTDSX 2055-028	0.55	2.8	38	3	3,070
UTDSX 2060-030	0.6	3	38	3	2,670
UTDSX 2065-033	0.65	3.3	38	3	3,070
UTDSX 2070-035	0.7	3.5	38	3	2,670
UTDSX 2075-038	0.75	3.8	38	3	3,070
UTDSX 2080-040	0.8	4	38	3	2,670
UTDSX 2085-043	0.85	4.3	38	3	3,070
UTDSX 2090-045	0.9	4.5	38	3	2,670
UTDSX 2095-048	0.95	4.8	38	3	3,070
UTDSX 2100-050	1	5	38	3	2,480
UTDSX 2105-053	1.05	5.3	38	3	2,480
UTDSX 2110-055	1.1	5.5	38	3	2,480
UTDSX 2115-058	1.15	5.8	38	3	2,480
UTDSX 2120-060	1.2	6	38	3	2,480
UTDSX 2125-063	1.25	6.3	38	3	2,480
UTDSX 2130-065	1.3	6.5	38	3	2,480
UTDSX 2135-068	1.35	6.8	38	3	2,480
UTDSX 2140-070	1.4	7	38	3	2,480
UTDSX 2145-073	1.45	7.3	38	3	2,480
UTDSX 2150-075	1.5	7.5	38	3	2,480
UTDSX 2155-078	1.55	7.8	38	3	2,480
UTDSX 2160-080	1.6	8	38	3	2,480
UTDSX 2165-083	1.65	8.3	38	3	2,670
UTDSX 2170-085	1.7	8.5	38	3	2,670
UTDSX 2175-088	1.75	8.8	38	3	2,670
UTDSX 2180-090	1.8	9	38	3	2,670
UTDSX 2185-093	1.85	9.3	38	3	2,670
UTDSX 2190-095	1.9	9.5	38	3	2,670
UTDSX 2195-098	1.95	9.8	38	3	2,670
UTDSX 2200-100	2	10	38	3	2,670

Features

A highly efficient and economic drill for both mass and prototype production of parts.
 UT MICRO COAT offers excellent performance for cutting soft materials.
 The new drill design and X thinning offer stable drilling performance with increased tool life.
 The 130° point angle ensures reduced burring of the drilled hole.
 The high rigidity short flute is perfect for high accuracy drilling and pilot hole drilling.

Diameter Tolerance: 0/-0.01 mm
 Point Angle: 130°

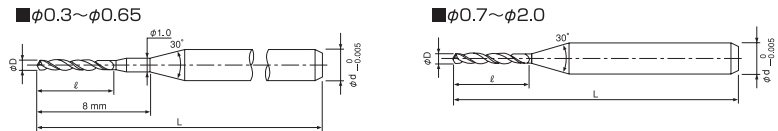

Drilling Conditions for UTDSX

WORK MATERIAL	STRUCTURAL STEELS SS400		CARBON STEELS S50C		ALLOY STEELS SCM / SUS		ALUMINUM ALLOYS A5052 / ADC12	
Velocity	Vc=20~35 m/min		Vc=20~35 m/min		Vc=15~20 m/min		Vc=20~60 m/min	
Diameter (mm)	Spindle Speed (min ⁻¹)	Feed Rate (mm/min)	Spindle Speed (min ⁻¹)	Feed Rate (mm/min)	Spindle Speed (min ⁻¹)	Feed Rate (mm/min)	Spindle Speed (min ⁻¹)	Feed Rate (mm/min)
0.3	20,000	100	20,000	100	16,000	80	20,000	200
0.4	17,400	130	17,400	180	12,000	90	20,000	440
0.5	15,900	150	15,900	250	9,500	100	20,000	680
0.6	14,100	170	14,100	300	8,000	110	20,000	920
0.7	12,800	180	12,800	340	6,700	110	20,000	1,160
0.8	11,900	200	11,900	380	6,300	120	20,000	1,400
0.9	10,500	200	10,500	390	6,000	130	17,500	1,430
1	9,500	200	9,500	400	6,000	150	16,000	1,500
1.5	7,300	220	7,300	500	4,500	180	13,000	1,960
2	5,600	230	5,600	560	3,000	160	9,500	2,030
Peck Amount	0.3D		0.5D		0.3D		1.0D	

- Note:
- Recommend shallower drilling than flute length (under ϕ 1:1D, ϕ 1 and over: 0.5D).
 - Recommend water soluble or oil coolant.
 - Recommend oil coolant for Titanium Alloys and Heat Resistant Alloys.

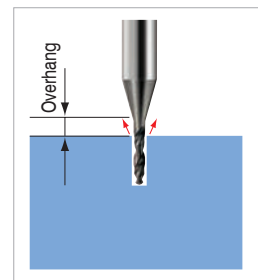

φ3mm Shank
V Series

UDC-PCD
Series

CBN
Series

Square

Long Neck
Square

Radius

Long Neck
Radius

Taper Neck
Radius

Ball / Long
Shank Ball

Long Neck
Ball

Taper Neck
Ball

Taper

Barrel

Spiral
V Cutter

Drill

Technical Data

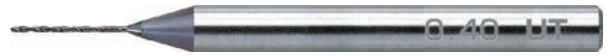

Size $\phi 0.1 \sim \phi 3$

C-UMD



Material Applications (★ Highly Recommended ● Recommended ○ Suggested)

Work Material																	
Carbon Steels S45C S55C	Alloy Steels SK / SCM SUS	Prehardened Steels NAK HPM	Hardened Steels					Cast Iron	Aluminum Alloys	Graphite	Copper	Plastics	Glass Filled Plastics	Titanium Alloys	Heat Resistant Alloys	Cemented Carbide	Hard Brittle (Non-Metallic) Materials
			~50HRC	~55HRC	~60HRC	~65HRC	~70HRC										
●	●	○	Contact sales when drilling over 45HRC.					○	●		○			○	○		

■ $\phi 0.1 \sim \phi 0.25$

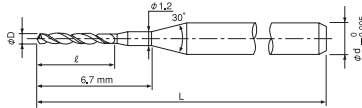

■ $\phi 0.26 \sim \phi 0.65$

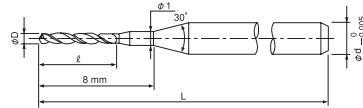

■ $\phi 0.66 \sim \phi 3$

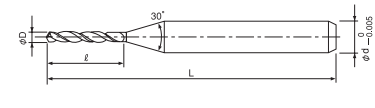

Actual tool geometries for some specifications and tolerances may differ from above drawings. $\phi 3$ is Straight type.

Diameter Tolerance : $\phi D \leq \phi 3$: $\phi D -0.005$
Point Angle : 150°

Total 225 models

Unit (mm)

Model Number	Diameter ϕD	Flute Length ℓ	Overall Length L	Shank Diameter ϕd	Suggested Retail Price ¥
C-UMD 2010-012	0.1	1.2	38	3	5,500
C-UMD 2011-012	0.11	1.2	38	3	6,050
C-UMD 2012-014	0.12	1.4	38	3	6,050
C-UMD 2013-014	0.13	1.4	38	3	6,050
C-UMD 2014-014	0.14	1.4	38	3	6,050
C-UMD 2015-020	0.15	2	38	3	5,060
C-UMD 2016-020	0.16	2	38	3	5,390
C-UMD 2017-020	0.17	2	38	3	5,390
C-UMD 2018-020	0.18	2	38	3	5,390
C-UMD 2019-020	0.19	2	38	3	5,390
C-UMD 2020-025	0.2	2.5	38	3	4,400
C-UMD 2021-025	0.21	2.5	38	3	4,950
C-UMD 2022-025	0.22	2.5	38	3	4,950
C-UMD 2023-025	0.23	2.5	38	3	4,950
C-UMD 2024-025	0.24	2.5	38	3	4,950
C-UMD 2025-030	0.25	3	38	3	4,950
C-UMD 2026-030	0.26	3	38	3	4,730
C-UMD 2027-030	0.27	3	38	3	4,730
C-UMD 2028-030	0.28	3	38	3	4,730
C-UMD 2029-030	0.29	3	38	3	4,730
C-UMD 2030-050	0.3	5	38	3	3,850
C-UMD 2031-050	0.31	5	38	3	4,730
C-UMD 2032-050	0.32	5	38	3	4,730
C-UMD 2033-050	0.33	5	38	3	4,730

Unit (mm)

Model Number	Diameter ϕD	Flute Length ℓ	Overall Length L	Shank Diameter ϕd	Suggested Retail Price ¥
C-UMD 2034-050	0.34	5	38	3	4,730
C-UMD 2035-060	0.35	6	38	3	4,290
C-UMD 2036-060	0.36	6	38	3	4,730
C-UMD 2037-060	0.37	6	38	3	4,730
C-UMD 2038-060	0.38	6	38	3	4,730
C-UMD 2039-060	0.39	6	38	3	4,730
C-UMD 2040-070	0.4	7	38	3	3,850
C-UMD 2041-070	0.41	7	38	3	4,730
C-UMD 2042-070	0.42	7	38	3	4,730
C-UMD 2043-070	0.43	7	38	3	4,730
C-UMD 2044-070	0.44	7	38	3	4,730
C-UMD 2045-070	0.45	7	38	3	4,290
C-UMD 2046-070	0.46	7	38	3	4,730
C-UMD 2047-070	0.47	7	38	3	4,730
C-UMD 2048-070	0.48	7	38	3	4,730
C-UMD 2049-070	0.49	7	38	3	4,730
C-UMD 2050-070	0.5	7	38	3	4,290
C-UMD 2051-070	0.51	7	38	3	4,290
C-UMD 2052-070	0.52	7	38	3	4,290
C-UMD 2053-070	0.53	7	38	3	4,290
C-UMD 2054-070	0.54	7	38	3	4,290
C-UMD 2055-070	0.55	7	38	3	3,410
C-UMD 2056-070	0.56	7	38	3	4,290
C-UMD 2057-070	0.57	7	38	3	4,290

Next Page →

Unit (mm)

Model Number	Diameter ϕD	Flute Length ℓ	Overall Length L	Shank Diameter ϕd	Suggested Retail Price ¥
C-UMD 2058-070	0.58	7	38	3	4,290
C-UMD 2059-070	0.59	7	38	3	4,290
C-UMD 2060-070	0.6	7	38	3	2,970
C-UMD 2061-070	0.61	7	38	3	4,290
C-UMD 2062-070	0.62	7	38	3	4,290
C-UMD 2063-070	0.63	7	38	3	4,290
C-UMD 2064-070	0.64	7	38	3	4,290
C-UMD 2065-070	0.65	7	38	3	3,410
C-UMD 2066-070	0.66	7	38	3	4,290
C-UMD 2067-070	0.67	7	38	3	4,290
C-UMD 2068-070	0.68	7	38	3	4,290
C-UMD 2069-070	0.69	7	38	3	4,290
C-UMD 2070-080	0.7	8	38	3	2,970
C-UMD 2071-080	0.71	8	38	3	4,290
C-UMD 2072-080	0.72	8	38	3	4,290
C-UMD 2073-080	0.73	8	38	3	4,290
C-UMD 2074-080	0.74	8	38	3	4,290
C-UMD 2075-080	0.75	8	38	3	3,410
C-UMD 2076-080	0.76	8	38	3	4,290
C-UMD 2077-080	0.77	8	38	3	4,290
C-UMD 2078-080	0.78	8	38	3	4,290
C-UMD 2079-080	0.79	8	38	3	4,290
C-UMD 2080-100	0.8	10	38	3	2,970
C-UMD 2081-100	0.81	10	38	3	4,290
C-UMD 2082-100	0.82	10	38	3	4,290
C-UMD 2083-100	0.83	10	38	3	4,290
C-UMD 2084-100	0.84	10	38	3	4,290
C-UMD 2085-100	0.85	10	38	3	3,410
C-UMD 2086-100	0.86	10	38	3	4,290
C-UMD 2087-100	0.87	10	38	3	4,290
C-UMD 2088-100	0.88	10	38	3	4,290
C-UMD 2089-100	0.89	10	38	3	4,290
C-UMD 2090-100	0.9	10	38	3	2,970
C-UMD 2091-100	0.91	10	38	3	4,290
C-UMD 2092-100	0.92	10	38	3	4,290
C-UMD 2093-100	0.93	10	38	3	4,290
C-UMD 2094-100	0.94	10	38	3	4,290
C-UMD 2095-100	0.95	10	38	3	3,410
C-UMD 2096-100	0.96	10	38	3	4,290
C-UMD 2097-100	0.97	10	38	3	4,290
C-UMD 2098-100	0.98	10	38	3	4,290
C-UMD 2099-100	0.99	10	38	3	4,290
C-UMD 2100-100	1	10	38	3	2,750
C-UMD 2101-100	1.01	10	38	3	3,410
C-UMD 2102-100	1.02	10	38	3	3,410
C-UMD 2103-100	1.03	10	38	3	3,410

Unit (mm)

Model Number	Diameter ϕD	Flute Length ℓ	Overall Length L	Shank Diameter ϕd	Suggested Retail Price ¥
C-UMD 2104-100	1.04	10	38	3	3,410
C-UMD 2105-100	1.05	10	38	3	2,750
C-UMD 2106-100	1.06	10	38	3	3,410
C-UMD 2107-100	1.07	10	38	3	3,410
C-UMD 2108-100	1.08	10	38	3	3,410
C-UMD 2109-100	1.09	10	38	3	3,410
C-UMD 2110-100	1.1	10	38	3	2,750
C-UMD 2111-100	1.11	10	38	3	3,410
C-UMD 2112-100	1.12	10	38	3	3,410
C-UMD 2113-100	1.13	10	38	3	3,410
C-UMD 2114-100	1.14	10	38	3	3,410
C-UMD 2115-100	1.15	10	38	3	2,750
C-UMD 2116-100	1.16	10	38	3	3,410
C-UMD 2117-100	1.17	10	38	3	3,410
C-UMD 2118-100	1.18	10	38	3	3,410
C-UMD 2119-100	1.19	10	38	3	3,410
C-UMD 2120-100	1.2	10	38	3	2,750
C-UMD 2121-100	1.21	10	38	3	3,410
C-UMD 2122-100	1.22	10	38	3	3,410
C-UMD 2123-100	1.23	10	38	3	3,410
C-UMD 2124-100	1.24	10	38	3	3,410
C-UMD 2125-100	1.25	10	38	3	2,750
C-UMD 2126-100	1.26	10	38	3	3,410
C-UMD 2127-100	1.27	10	38	3	3,410
C-UMD 2128-100	1.28	10	38	3	3,410
C-UMD 2129-100	1.29	10	38	3	3,410
C-UMD 2130-100	1.3	10	38	3	2,750
C-UMD 2131-100	1.31	10	38	3	3,410
C-UMD 2132-100	1.32	10	38	3	3,410
C-UMD 2133-100	1.33	10	38	3	3,410
C-UMD 2134-100	1.34	10	38	3	3,410
C-UMD 2135-100	1.35	10	38	3	2,750
C-UMD 2136-100	1.36	10	38	3	3,410
C-UMD 2137-100	1.37	10	38	3	3,410
C-UMD 2138-100	1.38	10	38	3	3,410
C-UMD 2139-100	1.39	10	38	3	3,410
C-UMD 2140-100	1.4	10	38	3	2,750
C-UMD 2141-100	1.41	10	38	3	3,410
C-UMD 2142-100	1.42	10	38	3	3,410
C-UMD 2143-100	1.43	10	38	3	3,410
C-UMD 2144-100	1.44	10	38	3	3,410
C-UMD 2145-100	1.45	10	38	3	2,750
C-UMD 2146-100	1.46	10	38	3	3,410
C-UMD 2147-100	1.47	10	38	3	3,410
C-UMD 2148-100	1.48	10	38	3	3,410
C-UMD 2149-100	1.49	10	38	3	3,410

3mm Shank
V SeriesUDC-PCD
SeriesCBN
SeriesSquare
Long Neck
SquareRadius
Long Neck
RadiusTaper Neck
RadiusBall / Long
Shank BallLong Neck
BallTaper Neck
Ball

Taper

Barrel

Spiral
V Cutter

Drill

Technical Data

Next Page →

Unit (mm)

Model Number	Diameter ϕD	Flute Length ℓ	Overall Length L	Shank Diameter ϕd	Suggested Retail Price ¥
C-UMD 2150-100	1.5	10	38	3	2,750
C-UMD 2151-100	1.51	10	38	3	3,410
C-UMD 2152-100	1.52	10	38	3	3,410
C-UMD 2153-100	1.53	10	38	3	3,410
C-UMD 2154-100	1.54	10	38	3	3,410
C-UMD 2155-100	1.55	10	38	3	2,750
C-UMD 2156-100	1.56	10	38	3	3,410
C-UMD 2157-100	1.57	10	38	3	3,410
C-UMD 2158-100	1.58	10	38	3	3,410
C-UMD 2159-100	1.59	10	38	3	3,410
C-UMD 2160-120	1.6	12	38	3	2,750
C-UMD 2161-120	1.61	12	38	3	3,630
C-UMD 2162-120	1.62	12	38	3	3,630
C-UMD 2163-120	1.63	12	38	3	3,630
C-UMD 2164-120	1.64	12	38	3	3,630
C-UMD 2165-120	1.65	12	38	3	2,970
C-UMD 2166-120	1.66	12	38	3	3,630
C-UMD 2167-120	1.67	12	38	3	3,630
C-UMD 2168-120	1.68	12	38	3	3,630
C-UMD 2169-120	1.69	12	38	3	3,630
C-UMD 2170-120	1.7	12	38	3	2,970
C-UMD 2171-120	1.71	12	38	3	3,630
C-UMD 2172-120	1.72	12	38	3	3,630
C-UMD 2173-120	1.73	12	38	3	3,630
C-UMD 2174-120	1.74	12	38	3	3,630
C-UMD 2175-120	1.75	12	38	3	2,970
C-UMD 2176-120	1.76	12	38	3	3,630
C-UMD 2177-120	1.77	12	38	3	3,630
C-UMD 2178-120	1.78	12	38	3	3,630
C-UMD 2179-120	1.79	12	38	3	3,630
C-UMD 2180-120	1.8	12	38	3	2,970
C-UMD 2181-120	1.81	12	38	3	3,630
C-UMD 2182-120	1.82	12	38	3	3,630
C-UMD 2183-120	1.83	12	38	3	3,630
C-UMD 2184-120	1.84	12	38	3	3,630
C-UMD 2185-120	1.85	12	38	3	2,970
C-UMD 2186-120	1.86	12	38	3	3,630
C-UMD 2187-120	1.87	12	38	3	3,630
C-UMD 2188-120	1.88	12	38	3	3,630
C-UMD 2189-120	1.89	12	38	3	3,630
C-UMD 2190-120	1.9	12	38	3	2,970
C-UMD 2191-120	1.91	12	38	3	3,630
C-UMD 2192-120	1.92	12	38	3	3,630

Unit (mm)

Model Number	Diameter ϕD	Flute Length ℓ	Overall Length L	Shank Diameter ϕd	Suggested Retail Price ¥
C-UMD 2193-120	1.93	12	38	3	3,630
C-UMD 2194-120	1.94	12	38	3	3,630
C-UMD 2195-120	1.95	12	38	3	2,970
C-UMD 2196-120	1.96	12	38	3	3,630
C-UMD 2197-120	1.97	12	38	3	3,630
C-UMD 2198-120	1.98	12	38	3	3,630
C-UMD 2199-120	1.99	12	38	3	3,630
C-UMD 2200-120	2	12	38	3	2,970
C-UMD 2205-120	2.05	12	38	3	3,850
C-UMD 2210-120	2.1	12	38	3	3,190
C-UMD 2212-120	2.12	12	38	3	3,190
C-UMD 2213-120	2.13	12	38	3	3,190
C-UMD 2214-120	2.14	12	38	3	3,190
C-UMD 2215-120	2.15	12	38	3	3,850
C-UMD 2220-120	2.2	12	38	3	3,190
C-UMD 2225-120	2.25	12	38	3	3,850
C-UMD 2229-120	2.29	12	38	3	3,190
C-UMD 2230-120	2.3	12	38	3	3,190
C-UMD 2231-120	2.31	12	38	3	3,190
C-UMD 2232-120	2.32	12	38	3	3,190
C-UMD 2235-120	2.35	12	38	3	3,850
C-UMD 2239-120	2.39	12	38	3	3,190
C-UMD 2240-120	2.4	12	38	3	3,190
C-UMD 2241-120	2.41	12	38	3	3,190
C-UMD 2242-120	2.42	12	38	3	3,190
C-UMD 2245-120	2.45	12	38	3	3,850
C-UMD 2250-120	2.5	12	38	3	3,190
C-UMD 2255-120	2.55	12	38	3	3,850
C-UMD 2256-120	2.56	12	38	3	3,190
C-UMD 2257-120	2.57	12	38	3	3,190
C-UMD 2260-120	2.6	12	38	3	3,190
C-UMD 2265-120	2.65	12	38	3	3,850
C-UMD 2270-120	2.7	12	38	3	3,190
C-UMD 2275-120	2.75	12	38	3	3,850
C-UMD 2277-120	2.77	12	38	3	3,190
C-UMD 2278-120	2.78	12	38	3	3,190
C-UMD 2279-120	2.79	12	38	3	3,190
C-UMD 2280-120	2.8	12	38	3	3,190
C-UMD 2285-120	2.85	12	38	3	3,850
C-UMD 2290-120	2.9	12	38	3	3,190
C-UMD 2295-120	2.95	12	38	3	3,850
C-UMD 2300-120	3	12	38	3	3,190

$\phi 3\text{mm}$ Shank
V Series

UDC-PCD
Series

CBN
Series

Square

Long Neck
Square

Radius

Long Neck
Radius

Taper Neck
Radius

Ball / Long
Shank Ball

Long Neck
Ball

Taper Neck
Ball

Taper

Barrel

Spiral
V Cutter

Drill

Technical Data

Drilling Conditions for C-UMD

WORK MATERIAL	CARBON STEELS S45C / S50C (~225HB)		ALLOY STEELS SK / SCM / SUS (225~325HB)		PREHARDENED STEELS HARDENED STEELS NAK / SKD (30~45HRC)		ALUMINUM ALLOYS A5052 etc.	
Velocity	Vc=25~40 m/min		Vc=15~25 m/min		Vc=10~15 m/min		Vc=20~60 m/min	
Diameter (mm)	Spindle Speed (min ⁻¹)	Feed Rate (mm/min)	Spindle Speed (min ⁻¹)	Feed Rate (mm/min)	Spindle Speed (min ⁻¹)	Feed Rate (mm/min)	Spindle Speed (min ⁻¹)	Feed Rate (mm/min)
0.3	20,000	40	15,900	30	10,600	10	20,000	400
0.4	17,400	50	11,800	40	8,000	20	19,900	690
0.5	15,900	80	9,500	50	6,400	30	20,000	1,000
0.6	14,100	80	7,900	40	5,300	20	19,900	1,050
0.7	12,800	90	6,800	50	4,500	20	19,900	1,120
0.8	11,900	100	6,000	50	4,000	20	19,900	1,190
0.9	10,500	100	6,200	50	3,500	20	17,600	1,220
1	9,500	100	6,400	60	3,200	20	15,900	1,270
2	5,600	170	3,200	100	1,600	20	9,500	950
3	3,700	150	2,700	110	1,600	20	6,400	640

Note:

- Recommend step amount 0.1D-0.2D. Recommend 0.2D-0.5D for Aluminum Alloys.
- Recommend water soluble or oil coolant.
- Recommend oil coolant for Titanium Alloys and Heat Resistant Alloys.

Ø3mm Shank
V Series

UDC-PCD
Series

CBN
Series

Square

Long Neck
Square

Radius

Long Neck
Radius

Taper Neck
Radius

Ball / Long
Shank Ball

Long Neck
Ball

Taper Neck
Ball

Taper

Barrel

Spiral
V Cutter

Drill

Technical Data

Drilling Example 1

SUS304

Comments

● Tip Damage:

Damage by chipping can be seen on the Carbide Drill. The High-Speed Steel Drill exhibits wear on the top chisel line and corners. The High-Speed Steel Drill also has the work material adhering to it.

● Hole Position:

The solid carbide drill has minimal deflection when compared to a High Speed steel model, through the entire drilling cycle.

Drilling Condition

Tool:	ϕ 0.6 × Flute Length 7mm
Work Material:	SUS304 (1.4301)
Spindle Speed:	8,000 min ⁻¹
Velocity:	15 m/min
Z Feed Rate:	50 mm/min
Chip Load:	0.00625 mm/rev
Peck Amount:	0.12 mm/time
Hole Depth:	2.4 mm
Number of Holes:	500 holes
Drilling Time :	25 min/100 holes
Overhang Length :	10 mm
Coolant:	Water Soluble (Nozzle)

Process Form

* Blind Hole Step Process

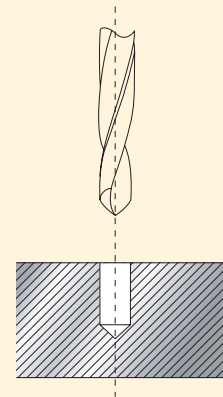

Comparison of Tip Damage

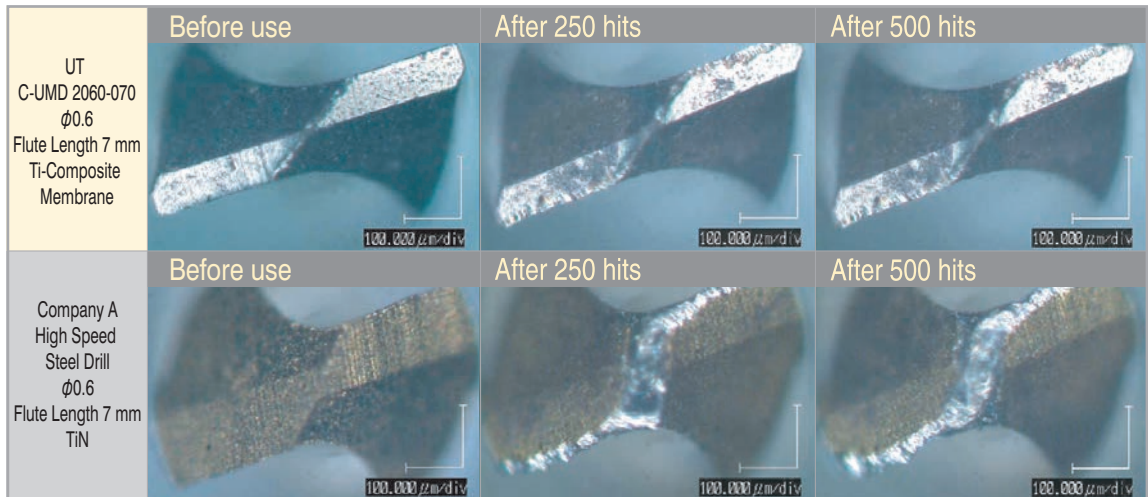

- ϕ 3mm Shank V Series
- UDC-PCD Series
- CBN Series
- Square
- Long Neck Square
- Radius
- Long Neck Radius
- Taper Neck Radius
- Ball / Long Shank Ball
- Long Neck Ball
- Taper Neck Ball
- Taper
- Barrel
- Spiral V Cutter
- Drill
- Technical Data

Comparison of Hole Position

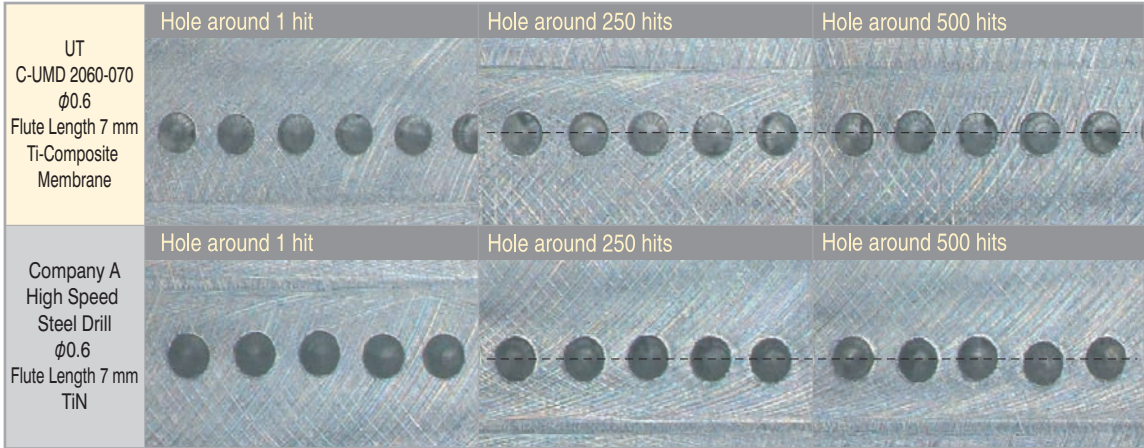

Drilling Example 2

SUS304

$\phi 0.1$ Drilling (about 800 holes)

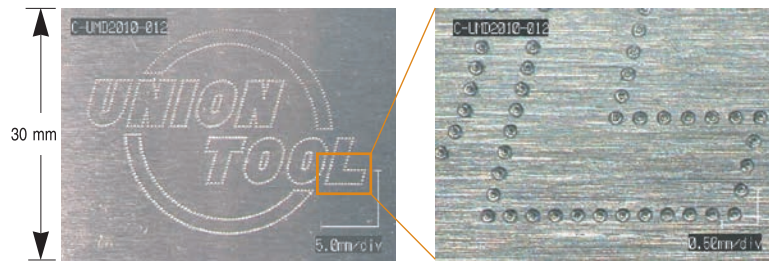

	Spindle Speed (min ⁻¹)	Feed Rate (mm/min)	Peck Amount (mm/time)	Hole Depth (mm)	Drilling Time	Coolant	Note
Acrylic $\phi 0.1$							
C-UMD $\phi 0.1$	20,000	20	0.02	1.00	1 h 30 min	Air Blow	Without pilot hole drilling
SUS304 (1.4301) $\phi 0.1$							
Center Drill+Chamfering C-UMD $\phi 0.2$	10,000	2	0.01	0.05	2 h 50 min	Water Soluble	
Drilling C-UMD $\phi 0.1$	12,000	4	0.02	0.20	3 h 27 min	Water Soluble	
Aluminum (A5052) $\phi 0.2$							
C-UMD $\phi 0.2$	16,000	80	0.04	1.50	2 h 50 min	Water Soluble	Using back-up board
NAK55 (AISI P21) $\phi 0.3$							
C-UMD $\phi 0.3$	15,000	15	0.06	1.50	3 h 35 min	Water Soluble	With pilot hole drilling
SUS304 (1.4301) $\phi 0.3$							
C-UMD $\phi 0.3$	16,000	30	0.06	1.50	2 h 24 min	Water Soluble	With pilot hole drilling

$\phi 3$ mm Shank
V Series

UDC-PCD
Series

CBN
Series

Square

Long Neck
Square

Radius

Long Neck
Radius

Taper Neck
Radius

Ball / Long
Shank Ball

Long Neck
Ball

Taper Neck
Ball

Taper

Barrel

Spiral
V Cutter

Drill

Technical Data



Size $\phi 0.3 \sim \phi 3$

UTDLX



Material Applications (★ Highly Recommended ● Recommended ○ Suggested)

Work Material																			
Structural Steels SS400	Carbon Steels S45C S55C	Alloy Steels SK / SCM SUS	Prehardened Steels NAK HPM	Hardened Steels					Cast Iron	Aluminum Alloys	Graphite	Copper	Plastics	Glass Filled Plastics	Titanium Alloys	Heat Resistant Alloys	Cemented Carbide	Hard Brittle (Non-Metallic) Materials	
				~ 50HRC	~ 55HRC	~ 60HRC	~ 65HRC	~ 70HRC											
●	●	●	○	Contact sales when drilling over 45HRC.					○	●		○				○	○		

Features

A highly efficient and economic drill for both mass and prototype production of parts.

UT MICRO COAT offers excellent performance for cutting soft materials.

The new drill design and X thinning offer stable drilling performance with increased tool life.

The 130° point angle ensures reduced burring of the drilled hole.

With an aspect ratio of 15:1, the drill is ideal for deep hole drilling, that requires high accuracy.

Diameter Tolerance: 0/-0.01 mm
Point Angle: 130°

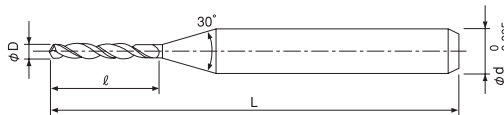

Total 55 models

Unit (mm)

Model Number	Diameter ϕD	Flute Length l	Overall Length L	Shank Diameter ϕd	Suggested Retail Price ¥
UTDLX 2030-045	0.3	4.5	38	3	4,600
UTDLX 2035-053	0.35	5.3	38	3	5,130
UTDLX 2040-060	0.4	6	38	3	4,600
UTDLX 2045-068	0.45	6.8	38	3	5,130
UTDLX 2050-075	0.5	7.5	38	3	4,600
UTDLX 2055-083	0.55	8.3	38	3	5,130
UTDLX 2060-090	0.6	9	45	3	4,600
UTDLX 2065-098	0.65	9.8	45	3	5,290
UTDLX 2070-105	0.7	10.5	45	3	4,600
UTDLX 2075-113	0.75	11.3	45	3	5,290
UTDLX 2080-120	0.8	12	45	3	4,600
UTDLX 2085-128	0.85	12.8	45	3	5,290

Next Page ➔

Unit (mm)

Model Number	Diameter ϕ D	Flute Length ℓ	Overall Length L	Shank Diameter ϕ d	Suggested Retail Price ¥
UTDLX 2090-135	0.9	13.5	45	3	4,600
UTDLX 2095-143	0.95	14.3	45	3	5,290
UTDLX 2100-150	1	15	50	3	4,600
UTDLX 2105-158	1.05	15.8	50	3	4,600
UTDLX 2110-165	1.1	16.5	50	3	4,600
UTDLX 2115-173	1.15	17.3	50	3	4,600
UTDLX 2120-180	1.2	18	50	3	4,600
UTDLX 2125-188	1.25	18.8	50	3	4,600
UTDLX 2130-195	1.3	19.5	50	3	4,600
UTDLX 2135-203	1.35	20.3	60	3	4,600
UTDLX 2140-210	1.4	21	60	3	4,600
UTDLX 2145-218	1.45	21.8	60	3	4,600
UTDLX 2150-225	1.5	22.5	60	3	4,600
UTDLX 2155-233	1.55	23.3	60	3	4,600
UTDLX 2160-240	1.6	24	60	3	4,600
UTDLX 2165-248	1.65	24.8	60	3	4,970
UTDLX 2170-255	1.7	25.5	60	3	4,970
UTDLX 2175-263	1.75	26.3	60	3	4,970
UTDLX 2180-270	1.8	27	60	3	4,970
UTDLX 2185-278	1.85	27.8	60	3	4,970
UTDLX 2190-285	1.9	28.5	60	3	4,970
UTDLX 2195-293	1.95	29.3	60	3	4,970
UTDLX 2200-300	2	30	60	3	4,970
UTDLX 2205-308	2.05	30.8	80	3	6,640
UTDLX 2210-315	2.1	31.5	80	3	5,500
UTDLX 2215-323	2.15	32.3	80	3	6,640
UTDLX 2220-330	2.2	33	80	3	5,500
UTDLX 2225-338	2.25	33.8	80	3	6,640
UTDLX 2230-345	2.3	34.5	80	3	5,500
UTDLX 2235-353	2.35	35.3	80	3	6,640
UTDLX 2240-360	2.4	36	80	3	5,500
UTDLX 2245-368	2.45	36.8	80	3	6,640
UTDLX 2250-375	2.5	37.5	80	3	5,500
UTDLX 2255-383	2.55	38.3	80	3	6,640
UTDLX 2260-390	2.6	39	80	3	5,500
UTDLX 2265-398	2.65	39.8	80	3	6,640
UTDLX 2270-405	2.7	40.5	80	3	5,500
UTDLX 2275-413	2.75	41.3	80	3	6,640
UTDLX 2280-420	2.8	42	80	3	5,500
UTDLX 2285-428	2.85	42.8	80	3	6,640
UTDLX 2290-435	2.9	43.5	80	3	5,500
UTDLX 2295-443	2.95	44.3	80	3	6,640
UTDLX 2300-450	3	45	80	3	5,500

ϕ 3mm Shank
V Series

UDC-PCD
Series

CBN
Series

Square
Long Neck
Square

Radius
Long Neck
Radius

Taper Neck
Radius

Ball / Long
Shank Ball

Long Neck
Ball

Taper Neck
Ball

Taper

Barrel

Spiral
V Cutter

Drill

Technical Data

Drilling Conditions for UTDLX

WORK MATERIAL	STRUCTURAL STEELS SS400		CARBON STEELS S50C		ALLOY STEELS SCM / SUS		ALUMINUM ALLOYS A5052	
Velocity	Vc=20~40 m/min		Vc=20~40 m/min		Vc=15~40 m/min		Vc=25~60 m/min	
Diameter (mm)	Spindle Speed (min ⁻¹)	Feed Rate (mm/min)	Spindle Speed (min ⁻¹)	Feed Rate (mm/min)	Spindle Speed (min ⁻¹)	Feed Rate (mm/min)	Spindle Speed (min ⁻¹)	Feed Rate (mm/min)
0.3	20,000	50	20,000	50	16,000	40	20,000	650
0.35	19,000	60	19,000	60	13,600	50	20,000	700
0.4	18,000	80	18,000	80	11,900	50	20,000	800
0.45	17,000	100	17,000	100	10,600	60	20,000	850
0.5	16,000	120	16,000	120	9,500	60	20,000	920
0.55	15,000	140	15,000	140	9,000	70	20,000	1,050
0.6	14,100	140	14,100	140	7,900	70	19,900	1,150
0.7	12,800	140	12,800	140	6,800	70	19,900	1,230
0.8	11,900	140	11,900	140	6,000	70	19,900	1,310
0.9	10,500	140	10,500	140	6,200	70	17,600	1,350
1	9,500	150	9,500	150	6,400	70	15,900	1,400
1.5	7,200	150	7,200	150	5,500	70	12,000	1,470
2	5,600	150	5,600	150	5,000	70	9,500	1,590
2.5	4,500	150	4,500	150	4,400	70	7,600	1,640
3	4,000	150	4,000	150	3,800	70	6,400	1,700
Peck Amount	0.5D		0.3D		0.1D		0.3D	

Note:

- Apply pre-drilling more than 3D depth before deep drilling. Recommend UTDSX for pre-drilling.
- Recommend shallower drilling than flute length (under ϕ 1:1D, ϕ 1 and over: 0.5D).
- Recommend water soluble or oil coolant.
- Recommend oil coolant for Titanium Alloys and Heat Resistant Alloys.

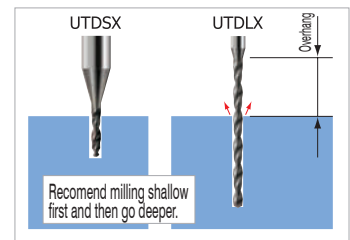

- φ3mm Shank V Series
- UDC-PCD Series
- CBN Series
- Square
- Long Neck Square
- Radius
- Long Neck Radius
- Taper Neck Radius
- Ball / Long Shank Ball
- Long Neck Ball
- Taper Neck Ball
- Taper
- Barrel
- Spiral V Cutter
- Drill
- Technical Data

Comparison of UTD (Carbide) and HSS Drill Bit SUS420J2 (Raw Material)

UTD can drill more than 2X holes compared to an HSS model

Tool Size	φ1.32 × 12 UTD proto type
Spindle Speed	5,000 min ⁻¹ (Vc: 21 m/min)
Feed Rate	200 mm/min (f: 0.04 mm/rev.)
Peck Amount	1.3 mm
Depth	7 mm blind hole

UTD prototype



HSS Drill (Company A: φ3 shank diameter with TIN coating for SUS)

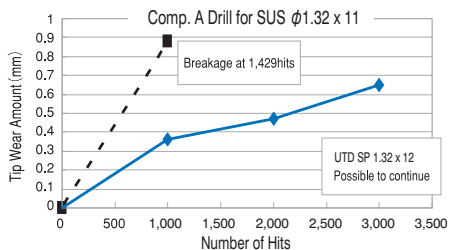
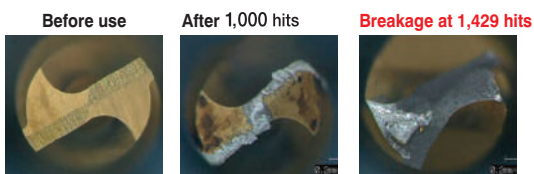

Flank wear comparison with HSS

Drilling test with various materials (Comparison of with / without thinning)

Smooth chip evacuation using the X-thinning design, offers greater resistance to breakage and more accurate drilling

Drill Size : φ1.0 x 15
 Tool : UTDLX 2100-150 (with thinning)
 Test Tool: φ1.0 x 15 (without thinning)

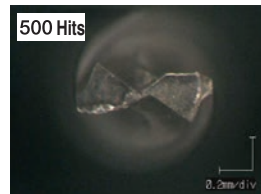
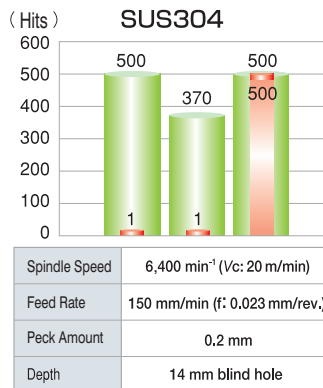
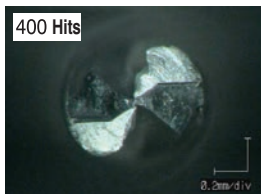
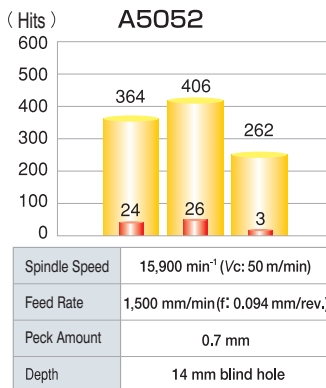
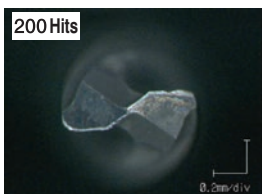
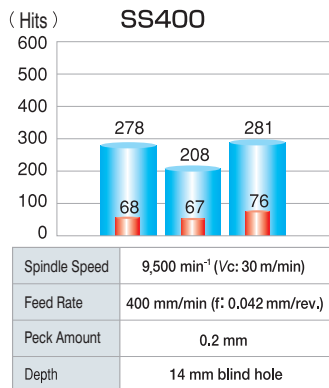
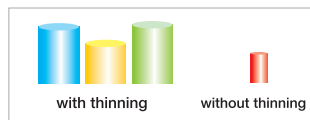

φ3mm Shank V Series

UDC-PCD Series

CBN Series

Square

Long Neck Square

Radius

Long Neck Radius

Taper Neck Radius

Ball / Long Shank Ball

Long Neck Ball

Taper Neck Ball

Taper

Barrel

Spiral V Cutter

Drill

Technical Data



Size $\phi 0.02 \sim \phi 0.1$ Refer to page 23 for material applications.

PMD STD

h4 tolerance 3.175 shank Shrink-fit compatible

Features

Flute length L/D 10D
 Diameter tolerance 0/-3 μ m
 4-facet drill point

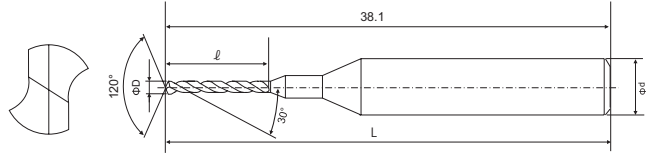

Total 17 models

Unit (mm)

Product code	Model Number	Diameter ϕD	Diameter tolerance	Flute length l	Overall length L	Shank Diameter ϕd	Suggested Retail Price ¥
140-0001	PMD STD 0.02 x 0.2	0.020	+0.000/-0.003	0.2	38.1	3.175	28,000
140-0002	PMD STD 0.025 x 0.3	0.025		0.3			28,000
140-0003	PMD STD 0.03 x 0.3	0.030		0.3			16,100
140-0004	PMD STD 0.035 x 0.4	0.035		0.4			16,100
140-0005	PMD STD 0.04 x 0.4	0.040		0.4			14,800
140-0006	PMD STD 0.045 x 0.5	0.045		0.5			14,800
140-0007	PMD STD 0.05 x 0.5	0.050		0.5			13,500
140-0008	PMD STD 0.055 x 0.6	0.055		0.6			13,500
140-0009	PMD STD 0.06 x 0.6	0.060		0.6			12,200
140-0010	PMD STD 0.065 x 0.7	0.065		0.7			12,200
140-0011	PMD STD 0.07 x 0.7	0.070		0.7			10,900
140-0012	PMD STD 0.075 x 0.8	0.075		0.8			10,900
140-0013	PMD STD 0.08 x 0.8	0.080		0.8			9,600
140-0014	PMD STD 0.085 x 0.9	0.085		0.9			9,600
140-0015	PMD STD 0.09 x 0.9	0.090		0.9			8,300
140-0016	PMD STD 0.095 x 1.0	0.095		1.0			8,300
140-0017	PMD STD 0.1 X 1.0	0.100		1.0			7,000

P Series Drill Features

Ultra-precision drill that utilizes the technology cultivated with PCB drills.
 All sizes with diameter tolerance 0/-0.003 and shank diameter tolerance h4 can be used with shrink-fit holders.

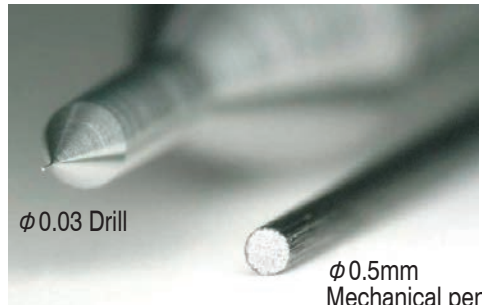

- $\phi 3$ mm Shank V Series
- UDC-PCD Series
- CBN Series
- Square
- Long Neck Square
- Radius
- Long Neck Radius
- Taper Neck Radius
- Ball / Long Shank Ball
- Long Neck Ball
- Taper Neck Ball
- Taper
- Barrel
- Spiral V Cutter
- Drill
- Technical Data



Size $\phi 0.02 \sim \phi 0.1$ Refer to page 23 for material applications.

PMD PLT

h4
tolerance3.175
shankShrink-fit
compatible

Features

For pilot drilling
Flute Length L/D 2D
Diameter tolerance 0/-3 μm
4-facet drill point

Total 11 models

Unit (mm)

Product code	Model Number	Diameter ϕD	Diameter tolerance	Flute length ℓ	Overall length L	Shank Diameter ϕd	Suggested Retail Price ¥
※1	PMD PLT 0.02 X 0.04	0.020	※1	0.04	38.1	3.175	※1
※1	PMD PLT 0.0225 X 0.045	0.0225		0.045			※1
140-0018	PMD PLT 0.025 X 0.05	0.025	-0.003/-0.006	0.05			28,000
140-0019	PMD PLT 0.03 X 0.06	0.030	-0.005/-0.008	0.06			16,100
140-0020	PMD PLT 0.04 X 0.08	0.040		0.08			14,800
140-0021	PMD PLT 0.05 X 0.10	0.050		0.10			13,500
140-0022	PMD PLT 0.06 X 0.12	0.060		0.12			12,200
140-0023	PMD PLT 0.07 X 0.14	0.070		0.14			10,900
140-0024	PMD PLT 0.08 X 0.16	0.080		0.16			9,600
140-0025	PMD PLT 0.09 X 0.18	0.090		0.18			8,300
140-0026	PMD PLT 0.1 X 0.20	0.100		0.20			7,000

※ 1 These sizes are special items. Please contact our sales representative for details.

※ 2 Special sizes can be manufactured upon request. Please contact our sales representative for details.

Refer to page 23 for material applications.

PSM

h4
tolerance3.175
shankShrink-fit
compatible

Features

For Chamfering · Counter sink · Center drill
Taper angle 90°

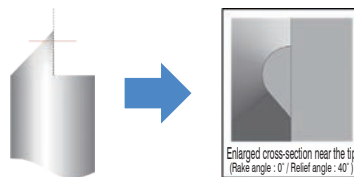

Total 1 model

Unit (mm)

Product code	Model Number	Diameter ϕD	Half Included Angle A	Overall length L	Shank Diameter ϕd	Suggested Retail Price ¥
141-9001	PSM N603A 1.0 90°	1.0	45°	38.1	3.175	6,000

※ Special sizes can be manufactured upon request. Please contact our sales representative for details.

$\phi 3\text{mm}$ Shank
V Series

UDC-PCD
Series

CBN
Series

Square

Long Neck
Square

Radius

Long Neck
Radius

Taper Neck
Radius

Ball / Long
Shank Ball

Long Neck
Ball

Taper Neck
Ball

Taper

Barrel

Spiral
V Cutter

Drill

Technical Data

φ0.06 Ultrafine hole processing on super engineering plastic

Tool

Center PSM N603A 1.0 × 90° (Center depth 0.003 mm)
 Pilot PMD PLT 0.06 × 0.12 (Pilot depth 0.009 mm)
 Through PMD STD 0.06 × 0.6

Drilling condition

Drilling depth	0.4 mm
Hole wall pitch	0.0415 mm
Spindle speed	20,000 min ⁻¹
Feed rate	10 mm/min
Peck Amount	0.005 mm/time
Hit count	961 hits
Coolant	Oil mist

Work surface

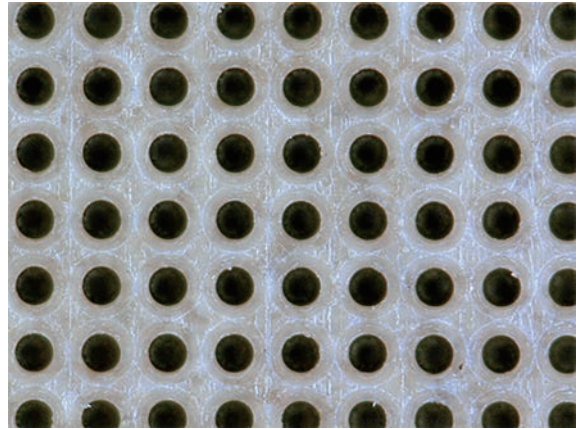

Hole diameter Avg ± 3σ φ0.0578 ± 0.0006

Hole registration accuracy

	Entry side	Exit side
Avg + 3σ (mm)	0.0021	0.0028
Max (mm)	0.0021	0.0041

Entry side

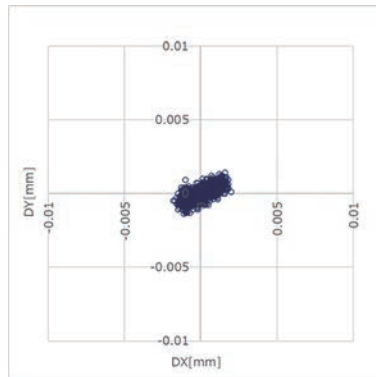

Exit side

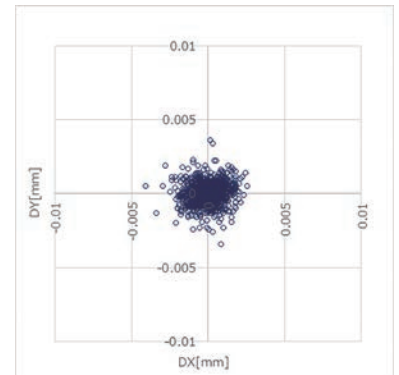

Ø3mm Shank
V Series

UDC-PCD
Series

CBN
Series

Square

Square

Long Neck
Square

Radius

Radius

Long Neck
Radius

Taper Neck
Radius

Ball

Ball / Long
Shank Ball

Long Neck
Ball

Taper Neck
Ball

Taper

Taper

Barrel

Spiral
V Cutter

Drill

Technical Data

OPTECH-MES/MES-D50



Non-contact dynamic run out measurement of the tool with Micro Eyes !

Features

- Diameter & Run-out detection improves the milling quality and stability.**
 Allowing the process to operate at the optimum condition by controlling the Machine spindle & tool setting.
- Prevents problems with tool life by detecting the tool tip.**
 Detects tool damage & wear on micro tools.
- Price cut from the conventional product.**
 Priced below the current OPTECH-Me/EDR-D20 measuring device.

Measuring example

■ End mill Measuring Accuracy (Diameter)

Spindle speed (min ⁻¹)	End mill size (mm)					
	φ0.2	φ0.5	φ0.9	φ2.0	φ2.5	φ3.0
0	-1	0	0	1	1	0
30,000	-1	0	-1	0	-1	-1
60,000	-1	-1	-2	-	-	-
120,000	-1	-	-	-	-	-

Unit (μm)

■ Tool tip detection repeatability

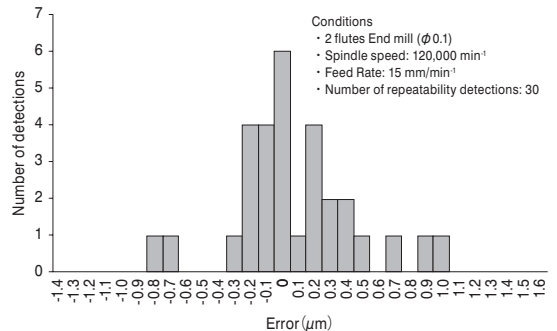

φ3mm Shank
V Series

UDC-PCD
Series

CBN
Series

Square

Long Neck
Square

Radius

Long Neck
Radius

Taper Neck
Radius

Ball / Long
Shank Ball

Long Neck
Ball

Taper Neck
Ball

Taper

Barrel

Spiral
V Cutter

Drill

Technical Data

Dimensions Plan (mm)

OPTECH-MES(sensor)

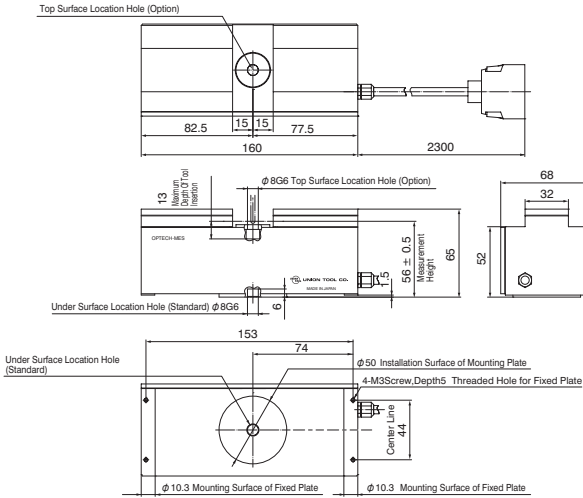

MES-D50(display)

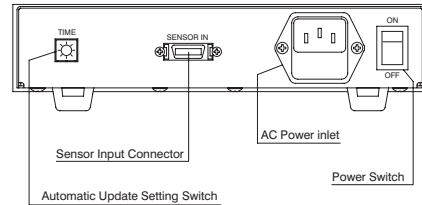
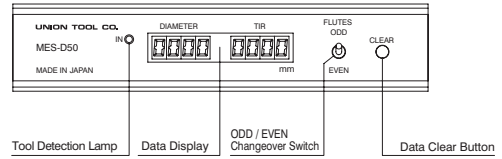

Optech Series OPTECH-MES/MES-D50

Items	Specification	
Measuring Items	<ul style="list-style-type: none"> Tool Diameter, Dynamic run-out (Even number of flutes) Diameter including dynamic run-out (Odd number of flutes) Spindle run-out by pin gauge Tool Tip Detection 	
Measuring Range	φ0.05 ~ φ3.0 (mm)	
Range of Runout Measurement	0 ~ 0.099 (mm)	
Resolution	1 (μm)	
Measuring Accuracy ^{※1}	Diameter	2 (μm) (φ0.05 ~ φ1.5 (mm)) 4 (μm) (φ1.5 ~ φ3.0 (mm))
	Run-out	within 2 (μm)
	Tool Tip Detection ^{※2} (Repeatability)	3 (μm) (Diameter below φ0.2 (mm), Square End mills, Radius End mills) 2 (μm) (Diameter below φ3.0 (mm), Ball End mills, Drills)
Measuring Spindle Rotation	<ul style="list-style-type: none"> within 120,000 (min⁻¹) (φ0.05 ~ φ0.1 (mm) or below) within 60,000 (min⁻¹) (φ0.1 ~ φ1.0 (mm) or below) within 30,000 (min⁻¹) (φ1.0 ~ φ3.0 (mm) or below) 	
Tool Tip Measurement Position ^{※3}	56 mm ± 0.5 mm from bottom surface of the detector	
Measuring Point Range	within ± 0.02 (mm) ^{※4}	
Dimensions/Mass	<ul style="list-style-type: none"> Sensor : W160 × D68 × H65 (mm) 0.7 (kg) Display : W200 × D200 × H42 (mm) 1.6 (kg) 	
Display	<ul style="list-style-type: none"> Diameter, Run-out display (Diameter, TIR), 4 digits each Tool tip detection indicator (IN) Lamp ON 	
Functions	<ul style="list-style-type: none"> Odd/even cutters switch (ODD/EVEN) Data refresh interval (TIME) No/Yes: Approximately 0.5s, 1.0s, 1.5s, 2.0s Clear (CLR) 	
Power Source	AC100 ~ 240 (V) 50/60 Hz	
Cable Length	2.3 (m)	
Price	¥440,000	

※1 Quantization errors are not included.

※2 Lamp lights when the tool is detected. Check the scale on milling machine for the actual value.

※3 Absolute position is different on individual tool. Adjust/Assemble the position within 56 ± 0.5mm.

※4 Set the tool position within ± 0.02 mm (XY direction) from the center of gauge hole.

φ3mm Shank
V Series

UDC-PCD
Series

CBN
Series

Square

Long Neck
Square

Radius

Long Neck
Radius

Taper Neck
Radius

Ball / Long
Shank Ball

Long Neck
Ball

Taper Neck
Ball

Taper

Barrel

Spiral
V Cutter

Drill

Technical Data



Calculation of Milling Conditions

Proper tool selection, machine condition, feed and speeds are essential for successful milling. The optimum machining conditions are calculated using the formulas below.

Formulas for calculation of end milling conditions

1. Velocity : V_C (m/min)

$$V_C = \frac{\pi \times D \times n}{1000}$$

$\pi = 3.14$ (Circular Constant)
 $D =$ Outside Diameter (mm)
 $n =$ Spindle Speed (min^{-1})

2. Spindle Speed : n (min^{-1})

$$n = \frac{1000 \times V_C}{\pi \times D}$$

$V_C =$ Velocity (m/min)
 $\pi = 3.14$ (Circular Constant)
 $D =$ Outside Diameter (mm)

3. Feed Rate : V_f (mm/min)

$$V_f = n \times z \times f_z$$

$n =$ Spindle Speed (min^{-1})
 $z =$ Number of flutes
 $f_z =$ Feed per tooth (mm/t)

4. Feed per tooth : f_z (mm/t)

$$f_z = \frac{V_f}{n \times z}$$

$V_f =$ Feed Rate (mm/min)
 $n =$ Spindle Speed (min^{-1})
 $z =$ Number of flutes

Explanation of terms used in parameters

1. Velocity V_C [Unit: m/min] :

The milling distance of an optional point on the circumference per unit (1 minute)

Related Value — $\left\{ \begin{array}{l} \text{Diameter } \phi D \text{ [mm]} : \text{ Twice the distance from the center of a circle (radius)} \\ \pi : \text{ Circular constant} = 3.14 \text{ (Unit : Nil)} \\ \text{Spindle Speed } n \text{ [min}^{-1}\text{]} : \text{ Revolutions per minute} \\ \text{[min}^{-1}\text{]} = \text{[rpm ; revolutions per minute]} \end{array} \right.$

ø3mm Shank
V Series

UDC-PCD
Series

CBN
Series

Square

Long Neck
Square

Radius

Long Neck
Radius

Taper Neck
Radius

Ball / Long
Shank Ball

Long Neck
Ball

Taper Neck
Ball

Taper

Barrel

Spiral
V Cutter

Drill

- Length of Circumference = Diameter \times pi : πD [mm]
- Velocity V_c : Milling length per minute = Length of circumference \times Spindle rotation speed

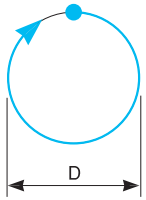

$$V_c = \pi \times D \text{ [mm]} \times n \text{ [min}^{-1}\text{]}$$



$$V_c = \frac{\pi \times D \text{ [mm]} \times n \text{ [min}^{-1}\text{]}}{1000} \text{ [m/min]}$$

Unit Conversion : 1 mm = 1/1000 m therefore....
 $D \text{ [mm]} = D/1000 \text{ [m]}$

2. Feed per tooth f_z [Unit:mm/t]

Related Value	—	Feed Rate V_f [mm/min]	: Amount of feed per minute
		Spindle Speed n [min $^{-1}$]	: Revolutions per minute [min $^{-1}$] = [rpm ; revolutions per minute]
		Number of Flutes z	: Number of flutes

- The amount of feed per rotation is described below. (rev = revolution)

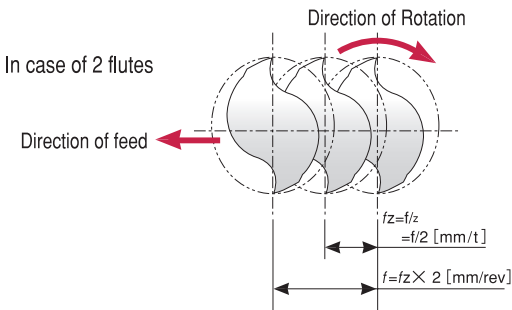

$$f = \frac{V_f \text{ [mm/min]}}{n \text{ [rev/min]}} = \frac{V_f}{n} \left[\frac{\text{mm}}{\text{min}} \right] \times \left[\frac{\text{min}}{\text{rev}} \right]$$

$$= \frac{V_f}{n} \text{ [mm/rev]}$$

※ [min $^{-1}$] = [rev/min]

- The amount of feed per flute is calculated using the feed rate divided by the number of flutes.

$$f_z = \frac{f \text{ [mm/rev]}}{z} = \frac{V_f}{n \times z} \text{ [mm/t]}$$

Ø3mm Shank
V Series

UDC-PCD
Series

CBN
Series

Square

Long Neck
Square

Radius

Long Neck
Radius

Taper Neck
Radius

Ball / Long
Shank Ball

Long Neck
Ball

Taper Neck
Ball

Taper

Barrel

Spiral
V Cutter

Drill

Technical Data

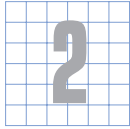

Using the Parameter Chart

example 1

<How to calculate spindle speed and feed rate >

For example: C-CES2080 NAK55 (39HRC) high speed milling

- (1) Determine the velocity V_c based on the type of work material or its hardness.
Parameter chart on page 177 shows $V_c=200$ m/min.
- (2) We know the Outside diameter, we can set spindle speed (n) and feed rate (V_f).
NAK55 is in the Prehardened Steel column. Velocity V_c is 200 m/min.
From the table, the Outside diameter (D) is 8.0 mm, then
 $n = 7900 \text{ min}^{-1}$ and $V_f = 405 \text{ mm/min}$.
- (3) Set the Z-axis cutting depth to approximately half of the outside diameter.

example 2

<How to calculate feed rate >

- Case 1. You want to work on S50C with a C-CES2030 End Mill, but the milling machine has $3,500 \text{ min}^{-1}$ maximum Spindle capability only. What is the feed rate with the conditions given?

Based on a feed per tooth 0.0135 mm/t
 $V_f : = (n \times z \times f_z) = (3,500 \times 2 \times 0.0135) = 94.5$
 n : Spindle speed
 z : Number of flutes
 f_z : Feed per tooth
 $n = 3,500 \text{ min}^{-1}$, $V_f : = 94.5 \text{ mm/min}$.

<How to calculate the spindle speed>

- Case 2. You want to work on NAK80 with a C-CES2100 End Mill at velocity 22 m/min. What is the spindle speed for this application?

$$n = \frac{1000 V_c}{\pi D} = \frac{1000 \times 22}{3.14 \times 10} = 700 \text{ min}^{-1}$$

- Case 3. Calculating the spindle speed when side milling using C-CTE 4100-3

Work material: Carbon Steel
 Velocity : 40 m/min.

Outside Diameter D is calculated about 1/3 to 1/2 of cutting depth from bottom.
 For example: If the blade length is 35 mm, cutting depth is 18 mm.

Outside Diameter $D_1 = (1/3 \times \text{Axial Depth } a_p \times \tan(\text{half included angle})) \times 2 + \text{tip diameter}$
 $= (1/3 \times 18 \times \tan 1.5^\circ) \times 2 + \phi 10 \doteq 10.3$

$$\text{Spindle speed } n = \frac{1000 V_c}{\pi D} = \frac{1000 \times 40}{3.14 \times 10.3} = 1,237 \text{ min}^{-1}$$

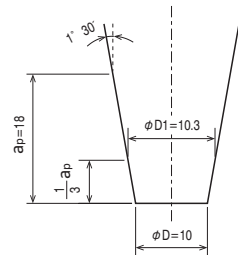

phi 3mm Shank
V Series

UDC-PCD
Series

CBN
Series

Square

Long Neck
Square

Radius

Long Neck
Radius

Taper Neck
Radius

Ball / Long
Shank Ball

Long Neck
Ball

Taper Neck
Ball

Taper

Barrel

Spiral
V Cutter

Drill

Technical Data

Diagram of End Mill Virtual Diameter

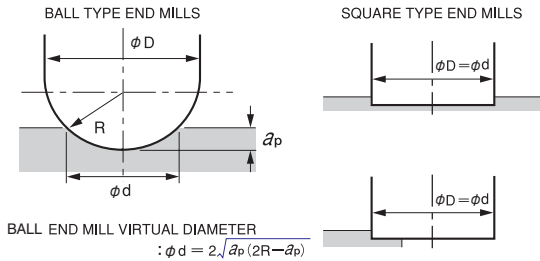

Square type diameter equals to the virtual diameter.
Ball type virtual diameter will vary depending on the contact point with work material and milling depth.
The velocity of Ball End Mill can be calculated by using the virtual diameter.

Velocity of virtual diameter (V) can be calculated by the following formula.

$$V_C(\text{m/min}) = \pi \times \phi d (\text{mm}) \times n (\text{min}^{-1}) / 1000$$

Ex.) With virtual diameter $\phi 1$ mm and spindle speed 30,000 (min^{-1}),

$$V_C(\text{m/min}) \text{ is } ; V_C(\text{m/min}) = 3.14 \times \phi 1 (\text{mm}) \times 30,000 (\text{min}^{-1}) / 1000 \\ = 94.2 \text{ m/min}$$

Virtual Diameter of Ball End Mill (mm)

a_p : Axial Depth (mm)

(Unit : mm)

R \ a_p	0.01	0.02	0.03	0.04	0.05	0.1	0.15	0.2	0.25	0.3	0.4
R0.1	0.087	0.120	0.143	0.160	0.173	0.200	—	—	—	—	—
R0.15	0.108	0.150	0.180	0.204	0.224	0.283	0.300	—	—	—	—
R0.2	0.125	0.174	0.211	0.240	0.265	0.346	0.387	0.400	—	—	—
R0.25	0.140	0.196	0.237	0.271	0.300	0.400	0.458	0.490	0.500	—	—
R0.3	0.154	0.215	0.262	0.299	0.332	0.447	0.520	0.566	0.592	0.600	—
R0.4	0.178	0.250	0.304	0.349	0.387	0.529	0.624	0.693	0.742	0.775	0.800
R0.5	0.199	0.280	0.341	0.392	0.436	0.600	0.714	0.800	0.866	0.917	0.980
R0.6	0.218	0.307	0.375	0.431	0.480	0.663	0.794	0.894	0.975	1.039	1.131
R0.7	0.236	0.332	0.405	0.466	0.520	0.721	0.866	0.980	1.072	1.149	1.265
R0.8	0.252	0.356	0.434	0.500	0.557	0.775	0.933	1.058	1.162	1.249	1.386
R0.9	0.268	0.377	0.461	0.531	0.592	0.825	0.995	1.131	1.245	1.342	1.497
R1	0.282	0.398	0.486	0.560	0.624	0.872	1.054	1.200	1.323	1.428	1.600
R1.5	0.346	0.488	0.597	0.688	0.768	1.077	1.308	1.497	1.658	1.800	2.040
R2	0.399	0.564	0.690	0.796	0.889	1.249	1.520	1.744	1.936	2.107	2.400
R2.5	0.447	0.631	0.772	0.891	0.995	1.400	1.706	1.960	2.179	2.375	2.713
R3	0.489	0.692	0.846	0.977	1.091	1.536	1.873	2.154	2.398	2.615	2.993
R4	0.565	0.799	0.978	1.129	1.261	1.778	2.170	2.498	2.784	3.040	3.487
R5	0.632	0.894	1.094	1.262	1.411	1.990	2.431	2.800	3.122	3.412	3.919
R6	0.693	0.979	1.198	1.383	1.546	2.182	2.666	3.072	3.428	3.747	4.308

R \ a_p	0.5	0.6	0.7	0.8	0.9	1	1.5	2	2.5	3
R0.5	1.000	—	—	—	—	—	—	—	—	—
R0.6	1.183	1.200	—	—	—	—	—	—	—	—
R0.7	1.342	1.386	1.400	—	—	—	—	—	—	—
R0.8	1.483	1.549	1.587	1.600	—	—	—	—	—	—
R0.9	1.612	1.697	1.755	1.789	1.800	—	—	—	—	—
R1	1.732	1.833	1.908	1.960	1.990	2.000	—	—	—	—
R1.5	2.236	2.400	2.538	2.653	2.750	2.828	3.000	—	—	—
R2	2.646	2.857	3.040	3.200	3.341	3.464	3.873	4.000	—	—
R2.5	3.000	3.250	3.470	3.666	3.842	4.000	4.583	4.899	5.000	—
R3	3.317	3.600	3.852	4.079	4.285	4.472	5.196	5.657	5.916	6.000
R4	3.873	4.214	4.521	4.800	5.056	5.292	6.245	6.928	7.416	7.746
R5	4.359	4.750	5.103	5.426	5.724	6.000	7.141	8.000	8.660	9.165
R6	4.796	5.231	5.625	5.987	6.321	6.633	7.937	8.944	9.747	10.392

- φ3mm Shank V Series
- UDC-PCD Series
- CBN Series
- Square
- Long Neck Square
- Radius
- Long Neck Radius
- Taper Neck Radius
- Ball / Long Shank Ball
- Long Neck Ball
- Taper Neck Ball
- Taper
- Barrel
- Spiral V Cutter
- Drill

Technical Data

Material Accepting Inspection

Chamfering

Shouldering

Shank Diameter Finishing



Mitsuke Factory

Groove Grinding



End Mills' Production Flow

We can flexibly deal with highly accurate grinding and complicated shape machining using our in-house developed production facilities at Mitsuke Factory, our factory dedicated to end mill manufacturing, located in Niigata Prefecture. We also develop inspection equipment for various processes and precise radius measuring instruments for ball end mills internally under our strict quality control system.

Washing



Coating

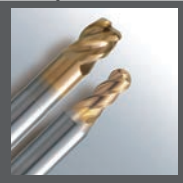

Radius Inspection



Marking

Final Inspection

Packaging and Labeling

φ3mm Shank V Series

UDC-PCD Series

CBN Series

Square

Long Neck Square

Radius

Long Neck Radius

Taper Neck Radius

Ball / Long Shank Ball

Long Neck Ball

Taper Neck Ball

Taper

Barrel

Spiral V Cutter

Drill

Technical Data

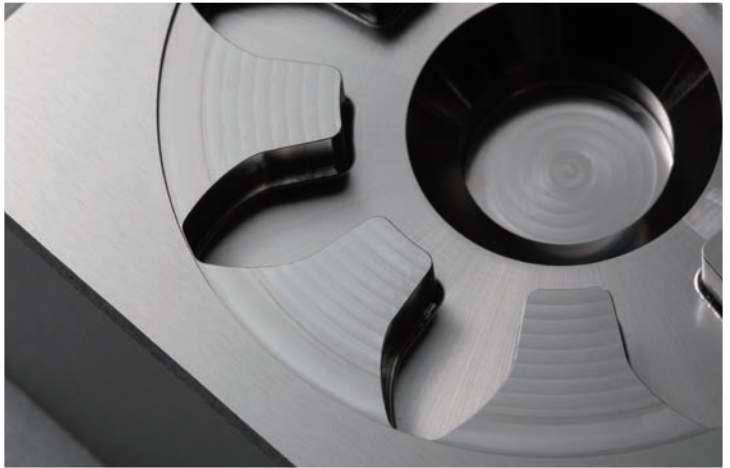
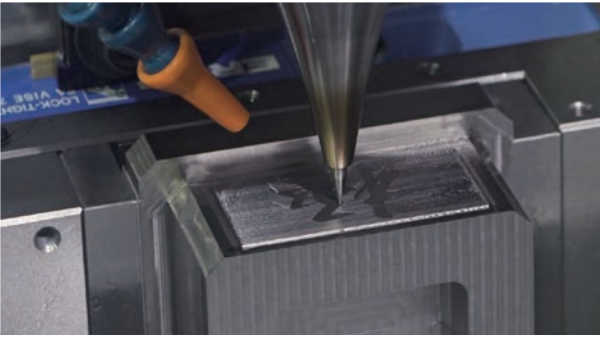

Milling Videos

<https://www.uniontool.co.jp/en/product/endmill/movie/>

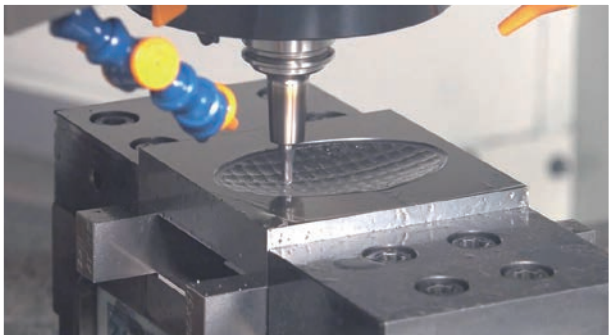
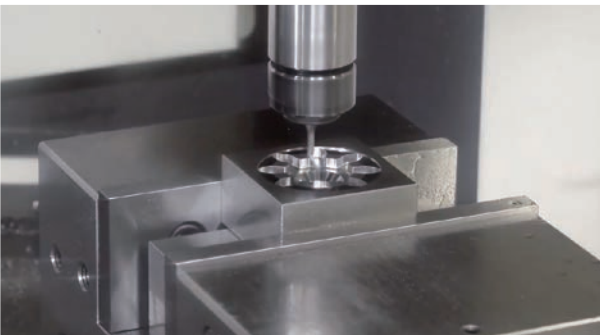
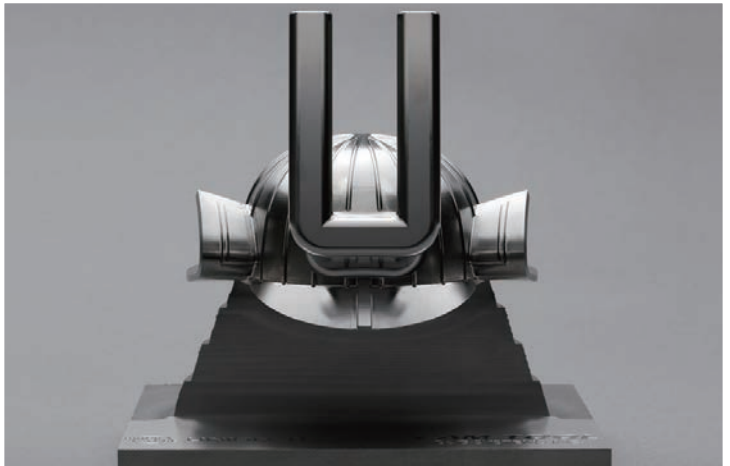

UNION TOOL GROUP

HEADQUARTERS

6-17-1 Minami-Ohi, Shinagawa-ku, Tokyo 140-0013, JAPAN
Tel: 81-3-5493-1023 Fax: 81-3-5493-1014

NAGAOKA FACTORY

TECHNICAL CENTER

NAGAOKA SALES OFFICE

2706-6 Togawa, Settaya-machi, Nagaoka-shi, Niigata 940-1104, JAPAN

MITSUKE FACTORY

3-1 Shinko-cho, Mitsuke-shi, Niigata 954-0076, JAPAN

KITAKANTO SALES OFFICE

Sesion 101, 1425 Egi-machi, Takasaki-shi, Gunma 370-0046, JAPAN

ANJO SALES OFFICE

Mikawa Anjo Hills 2F-A, 2-1-1 Mikawa Anjo-cho, Anjo-shi,
Aichi 446-0056, JAPAN

NAGOYA SALES OFFICE

8F NISSAY Ichinomiya BLDG, 1-2-8 Shinsei, Ichinomiya-shi,
Aichi 491-0912, JAPAN

OSAKA SALES OFFICE

picAsso Mikuni Building, 3-9-14 Niitaka, Yodogawa-ku, Osaka-shi,
Osaka 532-0033, JAPAN

U.S. UNION TOOL, INC.

(U.S. HEADQUARTERS)

1260 N. Fee Ana Street, Anaheim, CA 92807-1817 U.S.A.

Tel: 1-714-521-6242 Fax: 1-714-521-8642

NORTHERN CALIFORNIA REGIONAL SERVICE CENTER

(Customer Service, Santa Clara, California)

1805 Little Orchard Street, Suite 120, San Jose, CA 95125 U.S.A.

Tel: 1-408-982-0205 Fax: 1-408-982-0320

UPPER MIDWEST REGIONAL SERVICE CENTER

(Customer Service, Minneapolis, Minnesota)

155 Bridgepoint Drive, Unit 3 South St. Paul, MN 55075 U.S.A.

Tel: 1-651-552-0440 Fax: 1-651-552-0435

TAIWAN UNION TOOL CORP.

No.180, Zhong-Zun Street., 14 Neighborhood, Bin-Hai Vil.,

Lu-Zhu Dist., Taoyuan City, 338 TAIWAN

Tel: 886-3-354-3111 Fax: 886-3-354-3110

UNION TOOL EUROPE S.A.

Avenue des Champs-Montants 14aCH-2074 Marin /

Neuchatel SWITZERLAND

Tel: 41-32-756-6633

UNION TOOL (SHANGHAI) Co., LTD.

No.9-10, Lane 385, Gaoji Road, Sijing High New Technology

Development Zone, Songjiang District, Shanghai, 201601 CHINA

Tel: 86-21-5762-8577 Fax: 86-21-5762-8436

UNION TOOL HONG KONG LTD.

Unit 2803 & 05, 28/F, Peninsula Tower,

538 Castle Peak Road, Cheung Sha Wan, Kowloon, HONG KONG

Tel: 852-2370-3012 Fax: 852-2370-2111

DONGGUAN UNION TOOL LTD.

No.5, Hong Jin Road, Hongmei Town,

Dongguan City, Guangdong Province 523160, CHINA

Tel: 86-769-8884-8900 Tel: 86-769-8884-8901

Fax: 86-769-8884-8296

UNION TOOL SINGAPORE PTE LTD.

140 Paya Lebar Road #08-17, AZ @ Paya Lebar, SINGAPORE 409015

Tel: 65-6846-9309 Fax: 65-6846-0197

UNION TOOL (THAILAND) CO., LTD.

55/73 Moo 15 Bangsaothong Sub-District, Bangsaothong District,

Samutprakarn 10570 THAILAND

Tel: 66-2-130-0908 Fax: 66-2-130-0909



Scan here to view

1. Website catalogs
2. Catalog revision information



UNION TOOL CO.

<https://www.uniontool.co.jp/en/>

Price & Specifications are subject to change without notice.